



**X7**

V4.1

## Congratulations on your purchase of the AORUS Notebook!

This Manual will help you to get started with setting up your notebook. For more detailed information, please visit our website at <http://www.aorus.com>. All specifications are subject to the manufacturer's configuration at the time of shipping and may change without prior notice, written or otherwise.

## Using AORUS Notebook for the First Time

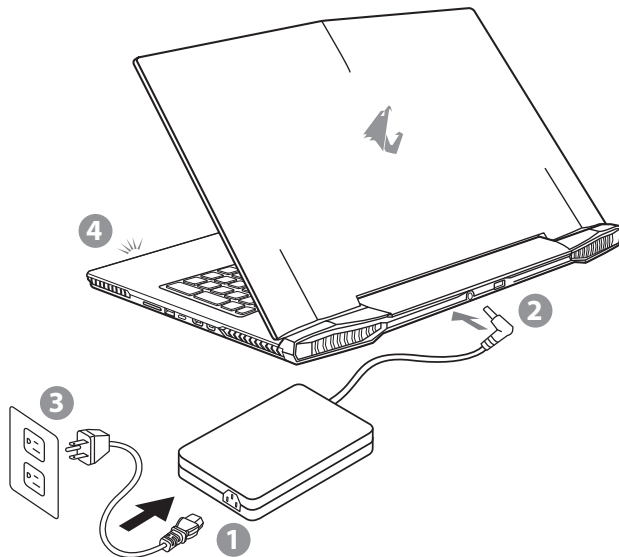

- 1 Connect the power cord to the AC adapter.
- 2 Connect the AC adapter to the DC-in jack on the back side of the notebook.
- 3 Connect the power cord to the power outlet.
- 4 While the Battery Indicator lights on, press the Power Button to turn on the notebook.

## IMPORTANT

- Ensure that your Notebook PC is connected to a grounded power adapter before turning it on for the first time.
- When using your Notebook PC on power adapter mode, the socket outlet must be near to the unit and easily accessible.
- Locate the input/output rating label on your Notebook PC and ensure that it matches the input/output rating information on your power adapter. Some Notebook PC models may have multiple rating output currents based on the available SKU.
- Power adapter information:
  - Input voltage: 100-240Vac
  - Input frequency: 50-60Hz
  - Rating output voltage: 19.5V



### Switching on the Power

After you turn on the notebook for the very first time, do not turn it off until the operating system has been configured. Please note that the volume for the audio will not function until Windows® Setup has completed.

### Booting Up the notebook for the First Time

Depending on your configuration, the Microsoft® Windows® Boot Screen may be the first screen that you will see as the notebook starts up. Follow the on screen prompts and instructions and enter your personal information to complete the setup of the Windows® Operating System.

# Your AORUS Notebook Tour

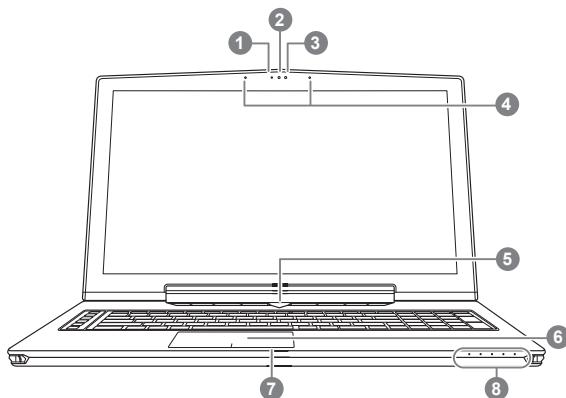

- 1 Webcam Status LED Indicator
- 2 Webcam
- 3 Light sensor
- 4 Microphone
- 5 Power Button
- 6 TouchPad
- 7 Battery Indicator Button
- 8 LED Indicators

- 1 Press the right button of touchpad to check the remaining battery power. Right click to show the remaining power percentage. As shown below, the battery life indicator is available when the laptop is shut down, in stand-by or hibernation.(Battery mode)



- 2
- Bluetooth Status LED
  - Wireless Lan Status LED
  - HDD Status LED
  - Battery Status LED
  - Power Status LED

	Bluetooth	Wireless Lan	HDD	Battery	Power
<10%	⦿	⦿	⦿	⦿	⦿
11-30%	●	○	○	○	○
31-50%	●	●	○	○	○
51-70%	●	●	●	○	○
71-90%	●	●	●	●	○
>90%	●	●	●	●	●

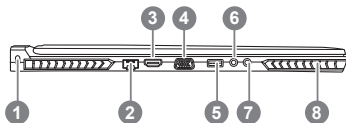

- 1 Kensington Lock Slot
- 2 Ethernet Port
- 3 Surround Port ①
- 4 D-sub (VGA) Port
- 5 USB 3.0 Port
- 6 Headphone Jack
- 7 Microphone Jack
- 8 Speaker

- ① Enjoy triple display visual pleasure by connecting HDMI, mini-DP and Surround port with 3 monitors (same model number).  
\*Caution:

- (1) Surround port is compatible with regular HDMI cable connecting television and PC.
- (2) Connect HDMI or mini-DP port to external monitor for dual screen display. Surround port does not support dual display.
- (3) Supported game title list please refer to NVIDIA official website.
- (4) NVIDIA Surround Technology is only available when connected to AC adapter.

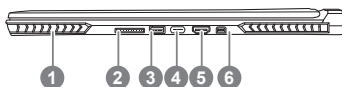

- 1 Speaker
- 2 SD Card Reader
- 3 USB 3.0 Port
- 4 USB 3.1 Port
- 5 HDMI 2.0 Port
- 6 Mini Display Port

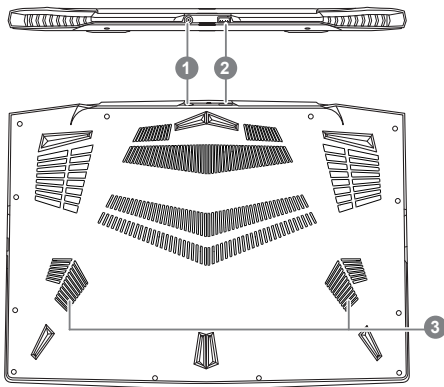

- 1 DC-in Jack
- 2 USB 3.0 Port
- 3 Subwoofer















**Warning:**

DO NOT remove the built-in lithium battery. For any service needs, please contact your local AORUS Authorized Service Center.

- Do not install the Notebook PC on a slant or a place prone to vibrations, or avoid using the Notebook PC in that location for a long time. This increases the risk that a malfunction or damage to the product will occur.
- Do not store and use Notebook PC in direct sunlight or the location where temperatures exceed 112°F (45°C) such as inside a vehicle. There is a danger of Lithium-ion battery expansion and aging.
- Do not use the Notebook PC in a badly ventilated location such as on bedding, on a pillow or cushion, etc, and do not use it in a location such as room with floor heating as it may cause the computer to overheat. Take care that the Notebook PC vents (on the side or the bottom) are not blocked especially in these environments. If the vents are blocked, it may be dangerous and cause the Notebook PC to overheat.







# Hotkeys

The computer employs hotkeys or key combinations to access most of the computer's controls like screen brightness and volume output. To activate hotkeys, press and hold the <Fn> key before pressing the other key in the hotkey combination.

Hotkey	Function	Description
Fn + F1 	Sleep	Put the computer in Sleep mode.
Fn + F2 	Wireless LAN	Turn the Wireless LAN function ON and OFF.
Fn + F3 	Brightness Down	Decrease the screen brightness.
Fn + F4 	Brightness Up	Increase the screen brightness.
Fn + F5 	Display Toggle	Switches display output between the display screen, external monitor (if connected) and both.
Fn + F6 	Touchpad Toggle	Turn the internal touchpad ON and OFF.
Fn + F7 	Speaker Toggle	Turn the speaker ON and OFF.
Fn + F8 	Volume Down	Decrease the sound volume.
Fn + F9 	Volume Up	Increase the sound volume.
Fn + F10 	Screen Display Toggle	Turn the screen display ON and OFF.
Fn + F11 	WiFi / Bluetooth Toggle	Turn the WiFi / Bluetooth function ON and OFF.
Fn + F12 	Webcam	Turn the internal webcam ON and OFF.

## Macro key

Macro keys can be set via Macro Engine, setting combination keys for complicated and/or general operation.

Macro key	Function	Description
	G	Macro group switch, press around 3 seconds as hardware switch on/off.
	G1	Self-definition Macro key
	G2	Self-definition Macro key
	G3	Self-definition Macro key
	G4	Self-definition Macro key
	G5	Self-definition Macro key

# X7 Operation manual

X7 equipped with many unique features, providing user an exceptional gaming experiences.



## Surround Port

Surround port is located on the left side of X7. User may connect X7 up to three external monitors with HDMI, mini Display and Surround port, presenting true visual surround effect and enjoy outstanding gaming experience. Surround port is compatible with television, PC's standard HDMI cable; however, only HDMI port and mini-DP support dual screen display. Please refer to NVIDIA official website for Surround's games supporting.

## Macro key

X7 features five macro keys and macro group switch, providing users to set their own preference of combinations, capable for switching in between maximum up to 25 sets of macros simultaneously. By using Macro Hub, users can easily access to their own defined recorded macro, and also adjust the macro sets, so the players are always steps ahead in games. For further detail instructions please refer Macro key setting manual.





## Killer LAN

Killer LAN can automatically adjust the priority of network transmission, allowing the user to have the best gaming network speed, by effectively reducing ping values and gain sequence control over different softwares that require network packet. User may set the software manually by Killer LAN's specific program with the highest priority network packets; Moreover, user may also configure the network for the download priority for online videos and games packets to achieve the best network optimization.

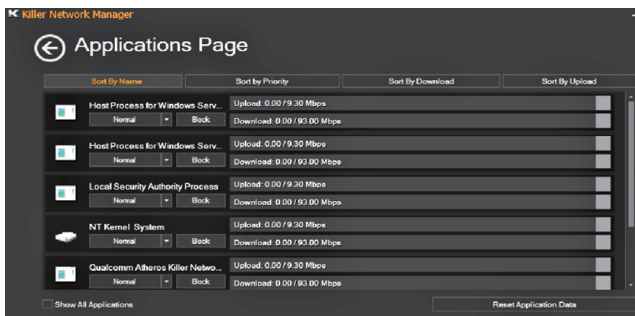

## Hardware Upgrade

User may upgrade memory or carry X7 to nearest repair center to upgrade; Please visit AORUS official website for compatible memory brands.

### Caution

Please ensure X7 is not powered on and unplugged to power source before the upgrade. Any damage during user's upgrade will not be covered by warranty, and user shall be responsible for related repair cost; hence recommend to carry your laptop to nearest service center for the upgrade.

### Memory









In order to maintain optimum compatibility and performance, please choose the slot that fits the condition below when upgrading memory to be installed to avoid compatibility problems or poor performance; For the supported memory module manufacturers, please visit AORUS official website FAQ for the reference.

## Battery Protection

When battery is in use for a period of time (not connected to power source and in high performance mode), Mass power discharging on battery in a short period of time may cause battery to run at high temperature and may shorten its lifespan. In order to protect the battery's lifespan, the battery will not be chargeable when its temperature is higher than 45 ° C. The mechanism for this is to protect the battery life. However, after user connects to power adapter, battery stops discharging and temperatures below 45 ° C, the battery will start charging back to the source and to maintain normal operation. Command & Control is a software that integrates a list of basic settings to a single interface, providing user a faster and better experience when customization is needed.

# X7 Command & Control

Command & Control is a software that integrates a list of basic settings to a single interface, providing user a faster and better experience when customization is needed.

Hotkey	Function	Description
	GPU SLI Switch	Enable or disable GPU SLI, when slave GPU turns off, it may increase battery life.(The Function of GPU SLI Switch may differ by X7 model. Please contact your local dealers or retailers for the latest product information.)
	Backlit Keyboard Switch	Turn On or Off keyboard backlit.
	Fan Control	Adjust fan speed according to user's preference.
	Quiet Mode	system will try to lower the fan speed to increase the battery life and reduce the noise without affecting light-weight tasks process such as using Word or 2D drawing.
	Normal	system will automatically adjust the fan speed upon your usage and try to keep the noise down.
	Gaming Mode	system will automatically adjust the fan speed upon your usage and have better performance without losing stability.
	Customize	User can enjoy adjusting different maximum fan speed
	Windows Key Lock	Lock or unlock Windows key



Mouse Speed Setting Adjust the mouse pointer speed according to user.



Volume Setting Adjust volume.



Brightness Setting Adjust Screen brightness.



Wi-Fi Switch Turn ON or OFF Wi-Fi connection.



Bluetooth Switch Turn On or Off Bluetooth connection.



Power Plan Setting Adjust the power plan by user usage in order to obtain maximum battery life or performance.



External Monitor Setting Switch between the computer screen and the external display video output, or simultaneous display.



System Gauge Enjoy the supercar gauge look on System Gauge and close look to system info including: CPU usage,GPU usage,RAM usag,Disk usage,Battery Life,system temperature and net speed.



Blue Light Killer Blue light killer is the new function under Command & Control. Just move the bar at bottom to adjust the brightness of blue light which eases your eyestrain.



On Screen Display Switch Enable/Disable the display of status while adjusting the settings through keyboard hotkeys.



USB Port Charge Set USB charging during the sleep mode or hybrination mode.

# Macro Engine Instruction

Welcome to use Macro Engine ! Macro Engine makes it much easier for you to control your Macro Key on X7. You can deal with complex key stroke combination by just one press on macro key, which brings you benefits both in work and game. Before using Macro Engine, please read following guide,thanks.

## 1 Launch Macro Engine



You can find the shortcut of Macro Engine on desktop. Just double click it.

## 2 The overview of Macro Engine



- 1 Profiles: View your current macro command settings.
- 2 Macros: Edit macro command functions and settings.
- 3 Settings: Update Macro Engine version or renew Macro Engine settings.
- 4 Macro Key Group Indicators: Indicate the activated Macro Key Group (the activated group indicator will light up)
- 5 Macro Key Function: Show the programmed Macro functions under the Macro Key Group, from G1 to G5.

### 3 Using Macro Engine

#### 1 Set Macro Key to basic function



- a. Click the G button on the left-top of the keyboard to switch to the Macro Key group you would like to use
- b. Click the Macro Key function brick to switch to the Macro Key group you would like to use



- c. Double-click the function you would like to use (ex. Media Player) in the Basic or Macros function area.



d. Complete the setting

## 2 Edit macro command functions and settings.



a. Click "Macros" (you can set up to 100 sets of macro)

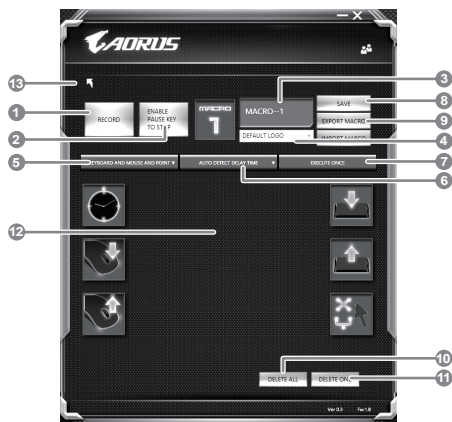

b. Overview of macro record panel (you can record your own macro here)

1. Start recording: Click when you're about to record the macro
2. Pause key Switch: Enable/Disable Pause key to stop recording.
3. Macro Name: Set the name of this macro
4. Import icon: Set icon for this macro. You can use default icon or upload your own icon
5. Record type: You can choose to record only mouse(or keyboard) movement, or record both. You can also decide to or not to record mouse position.
6. Record interval: You can decide to or not to record the interval of each movement(or You can set fixed interval time between every movement)
7. Execution way: You can set the macro execution way (execution once, repeat execution or repeat execution with deep press)
8. Export macro: Export your macro
9. Import macro: Import the macro
10. Delete all: Delete all movement in this macro
11. Delete selected: Delete selected movement
12. Movement list: it shows all movement you record
13. Exit: The system will inquire you if to save the recorded macro





- c. Start to record macro: When you click start button, the macro engine will start to record macro. All movement you made(mouse/keyboard) will be shown in the movement list. You can decide to use “pause” key or mouse click on stop button to stop recording based on your record range. Finishing recording: When you have done all movement, click exit button. The Macro Engine will inquire you if you want to save the macro. Click Yes then you can finish the record of your own macro.



- d. Complete the setting.

### 3 Edit "Settings" of Macro Engine

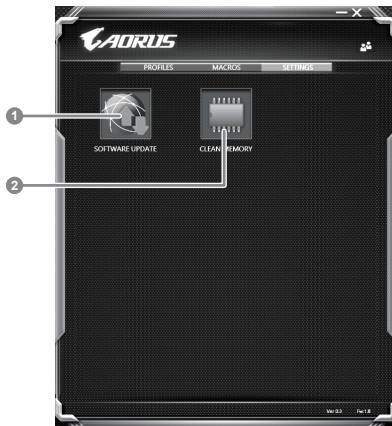

1. Software update: Update latest version of Macro Engine
2. Clean memory: Erase current Macro Engine settings

# Setup Your System for RAID 0/1

## ⚠ WARNING

- Please backup your data before you build and run RAID 0/1 on your system.
- RAID 1 needs two storage drives of the same specification and capacity in your laptop.
- RAID 0 needs two storage drives of the same specification in your laptop. Different capacity is acceptable.

1

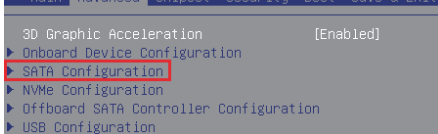

- Press F2 when computer starts to enter BIOS setup utility.
- Go to "Advanced" > "SATA configuration".

2

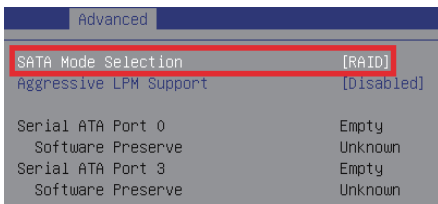

- Change "SATA Mode selection" from "AHCI" to "RAID".

3

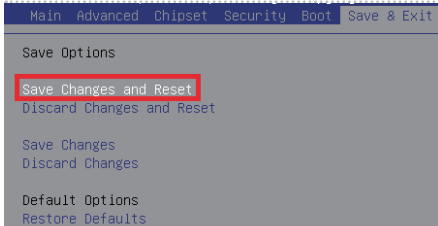

- Press F10 to Choose "Save Changes and Reset". The system will restart automatically.

4

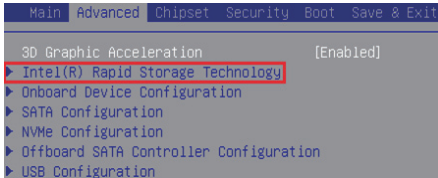

- After reboot, enter BIOS setup utility again .
- Go to "Advanced" > "Intel® Rapid Storage Technology".

5

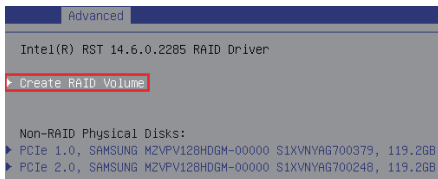

- Select "Create RAID Volume", then you could find Non-RAID Physical Disks.

6

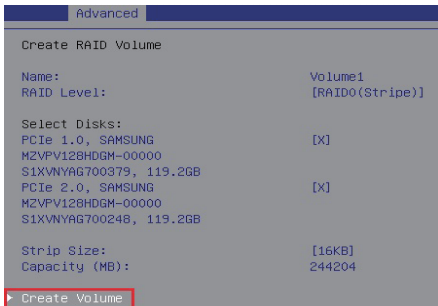

- Select the storage devices you would like to create RAID.
- Then, Select "Create Volume".

7

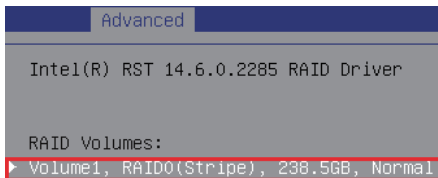

- The setting of RAID 0 is completed after saving and rebooting

# System Backup Guide

## ⚠ WARNING

- You can backup original recovery image through this application in case of losing by device damage.
- You can backup original recovery image to USB disk and restore the system if any storage system replacement with the recovery USB disk.
- Before you restore the system through the recovery USB disk, please make sure that you have already made the backup of your data.
- Please DO NOT shut down or un-plug the system when performing backup through recovery USB disk.

1



- Please plug in the USB disk which is at least 20GB in capacity to make the original image (backup the data in USB first. All data will be eliminated during the creation of recovery USB disk)

2



- Insert the driver disk to your optical drive and run the install of "System Backup" (for none-ODD model, please use USB ODD device or download from <http://www.AORUS.com>)

3



- Run the "System Backup" after finishing the install.

4



- Select your USB disk from the drop-down list and start to create the recovery USB disk.

5

- The window will pop out when the creation of recovery disk is done.
- Please press F12 on starting the system when you need to restore the system. Select "boot from recovery USB disk" and the system will be restored.
- The time needed for restore will be around 30 mins(time needed may vary by USB disk model) .

## Recovery Guide

### System Recovery (Restore your laptop operating system)

When something is going wrong with the laptop operating system, the storage of the laptop has a hidden partition containing a full back up image of the operating system that can be used to restore the system to factory default settings.



#### Note

- If the storage has been switched or the partition deleted, the recovery option will no longer be available and a recovery service will be needed.
- The recovery function is only available on devices with O/S preinstalled. Devices with DOS do not have the recovery function.

### Launch System Recovery

The system recovery feature is preinstalled before the laptop is shipped from the factory. The option menu allows you to launch the Windows recovery tool to reinstall the operating system to factory default. The brief introduction below will show you how to start the recovery tool and restore your system.



#### All ready to go

Make sure your PC is plugged in. This will take a few minutes.

## Windows 10 Recovery Guide

**1**

Turn off and restart the laptop.

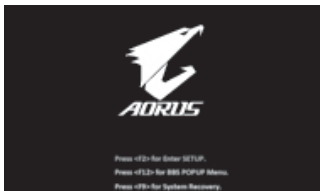
**2**

During the laptop turn on process, press and hold F9 key to launch the tool.

3



Choose “Troubleshoot” to enter the recovery settings. (Also you can choose “Continue” to exit recovery system and continue to Windows 10 for files or data backup.)



#### There are two options for system recovery

- **Reset this PC**

You can choose to keep or remove your files and then reinstalls Windows without losing your files.

- **AORUS Smart Recovery**

Your PC settings will be restored to factory default settings.

**Caution: All personal data and files will be lost.**

4



#### ■ Choose “Reset this PC”

##### ▶ Keep my files

Choose an account to continue. All apps will be removed, and settings will back to pure O/S (without AORUS app), but your personal files will be kept.

##### ▶ Remove everything

All apps, setting and personal files will be removed.

##### ⇒ Just remove my files

Only personal data and files will be removed, but computer settings will be kept.

##### ⇒ Fully clean the drive

The drive will be completely restored to factory default settings. It takes more time. > [Click on “Reset” to execute recovery function.]



#### Here are what will happen

- All of your personal files and apps will be removed.
- Your PC settings will be restored to pure O/S (without AORUS app) .



## ■ Choose “AORUS Smart Recovery”



The recovery will be activated and you will see the option buttons on the window. Click on “Yes” to start it.



### Caution

- Once the “Recovery” is selected, your personal data and files will be deleted after the laptop starts restoring, and the operating system will be reset to factory default settings.
- A progress indicator bar will show on the window when the recovery process is running. Please make sure the AC-adapter is plugged in and do not turn off the laptop.



After the system recovery is completed, you will see the option button on the window, please click on “Shutdown”.





## ■ Advanced options



### System Restore

Use a restore point recorded on your PC to restore Windows.



### System Image Recovery

Recover Windows using a specific system image file.



### Startup Repair

Fix problems that keep Windows from loading.



### Command Prompt

Use the Command Prompt for advanced troubleshooting.



### UEFI Firmware Settings

Change settings in your PC's UEFI firmware.



### Startup Settings

Change Windows Startup behavior.

## Appendix

---

### ■ Warranty & Service:

Warranty and service and related information please refer to the warranty card or service website as the below link: <http://www.aorus.com/>

### ■ FAQ:

FAQ (Frequent Asked Questions) please refer to the below link: <http://www.aorus.com/>