

GV-R467D3-1GI/ GV-R467D3-512I/ GV-R4650C-1GI/ GV-R4650C-512I

ATI Radeon™ HD 4670/4650 Graphics Accelerator

User's Manual

Rev. 102

12MM-R4600S-102R

Copyright

© 2008 GIGABYTE TECHNOLOGY CO., LTD

Copyright by GIGA-BYTE TECHNOLOGY CO., LTD. ("GBT"). No part of this manual may be reproduced or transmitted in any form without the expressed, written permission of GBT.

Trademarks

Third-party brands and names are the properties of their respective owners.

Notice

Please do not remove any labels on this graphics card. Doing so may void the warranty of this card.

Due to rapid change in technology, some of the specifications might be out of date before publication of this this manual. The author assumes no responsibility for any errors or omissions that may appear in this document nor does the author make a commitment to update the information contained herein.

Macrovision corporation product notice:

This product incorporates copyright protection technology that is protected by U.S. patents and other intellectual property rights. Use of this copyright protection technology must be authorized by Macrovision, and is intended for home and other limited viewing uses only unless otherwise authorized by Macrovision. Reverse engineering or disassembly is prohibited.

Declaration of Conformity

G.B.T. Technology Trading GmbH
Via, Manufacturer/importer
Bühlentopfer 16, Z4047 Homburg, Germany

(description of the apparatus, system, installation to which it refers)
declare that the product

VGA Card

GV-R467D3-1(GI)(GV-R467D3-512)

(reference to the specification under which conformity is declared)
in accordance with 89/339 EEC/EMC Directive

- | | | | |
|--|--|---|--|
| <input type="checkbox"/> EN 55011 | Limits and methods of measurement of radio disturbance characteristics of household electrical appliances of high frequency equipment | <input checked="" type="checkbox"/> EN 61000-3-2 | Disturbance in supply systems caused by harmonics in supply systems caused by household appliances and similar electrical equipment "Voltage fluctuations" |
| <input type="checkbox"/> EN 55013 | Limits and methods of measurement of radio disturbance characteristics of broadcast receivers and associated equipment | <input checked="" type="checkbox"/> EN 50082-1 | Information Technology equipment-Limits and methods of measurement |
| <input type="checkbox"/> EN 55014-1 | Limits and methods of measurement of radio disturbance characteristics of household electrical appliances, portable tools and similar electrical apparatus | <input checked="" type="checkbox"/> EN 50082-2 | Generic immunity standard Part 1: Residential, commercial and light industry industrial environment |
| <input type="checkbox"/> EN 55015 | Limits and methods of measurement of radio disturbance characteristics of fluorescent lamps and luminaires | <input checked="" type="checkbox"/> EN 55014-2 | Immunity requirements for household appliances, tools and similar apparatus |
| <input type="checkbox"/> EN 55020 | Immunity from radio interference of broadcast receivers and associated equipment | <input checked="" type="checkbox"/> EN 50079-2 | EMC requirements for uninterruptible power systems (UPS) |
| <input checked="" type="checkbox"/> EN 55022 | Limits and methods of measurement of radio disturbance characteristics of information technology equipment | | |
| <input type="checkbox"/> DIN VDE 0855 | Called distribution systems, Equipment for receiving sector distribution from sector and television signals | | |
| <input type="checkbox"/> Part 10 | | | |
| <input type="checkbox"/> Part 15 | | | |
| <input checked="" type="checkbox"/> CE marking | |  | (EC conformity marking) |
- The manufacturer also declares the conformity of above mentioned product with the test report number in accordance with IVD 2004/95/EC**
- EN 60065 Safety requirements for mains operated household and similar general use electrical appliances
- EN 60950 Safety for information technology equipment including electrical business equipment
- EN 60335 Safety of household and similar electrical appliances
- EN 50079-1 (General and Safety requirements for uninterruptible power systems (UPS))

Manufacturer/importer

Signature: Timmy Huang

Date: Sept. 30, 2008

Name: Timmy Huang

(Stamp)

DECLARATION OF CONFORMITY

Per FCC Part 2 Section 2.1077(a)



Responsible Party Name: G.B.T. INC. (U.S.A.)

Address: 17358 Railroad Street

City of Industry, CA 91748

Phone/Fax No: (818) 854-9338/ (818) 854-9339

hereby declares that the product

Product Name: VGA Card

Model Number: GV-R467D3-1(GI)/
GV-R467D3-5121

Conforms to the following specifications:

FCC Part 15, Subpart B, Section 15.107(a) and Section 15.109

(a), Class B Digital Device

Supplementary Information:

This device complies with part 15 of the FCC Rules. Operation is subject to the following two conditions: (1) This device may not cause harmful and (2) this device must accept any interference received, including that may cause undesired operation.

Representative Person's Name: ERIC LU

Signature: ERIC LU

Date: Sept. 30, 2008

Declaration of Conformity

G.B.T. Technology Trading GmbH
Via, Manufacturer/importer
Bühlentopfer 16, Z4047 Homburg, Germany

(Description of the apparatus, system, installation to which it refers)
declare that the product

GV-R4650C-1G1(GV-R4650C-5121)

VGA Card

(reference to the specification under which conformity is declared)
in accordance with 89/339 EEC/EMC Directive

- | | | | |
|---|---|---|--|
| <input type="checkbox"/> EN 55011 | Limits and methods of measurement of radio disturbance characteristics of household electrical appliances of high frequency equipment | <input checked="" type="checkbox"/> EN 61000-3-2 | Disturbance in supply systems caused by household appliances and similar electrical equipment "Voltage fluctuations" |
| <input type="checkbox"/> EN 55013 | Limits and methods of measurement of radio disturbance characteristics of broadcast receivers and associated equipment | <input checked="" type="checkbox"/> EN 61000-3-3 | Disturbance in supply systems caused by household appliances and similar electrical equipment "Voltage fluctuations" |
| <input type="checkbox"/> EN 55014-1 | Limits and methods of measurement of radio disturbance characteristics of portable tools and similar electrical apparatus | <input checked="" type="checkbox"/> EN 50082-1 | Generic immunity standard Part 1: Residential, commercial and light industry indoor environment |
| <input type="checkbox"/> EN 55015 | Limits and methods of measurement of radio disturbance characteristics of fluorescent lamps and luminaires | <input checked="" type="checkbox"/> EN 50082-2 | Generic immunity standard Part 2: Industrial environment |
| <input type="checkbox"/> EN 55020 | Immunity from radio interference of broadcast receivers and associated equipment | <input type="checkbox"/> EN 55014-2 | Immunity requirements for household appliances, tools and similar apparatus |
| <input checked="" type="checkbox"/> EN 55022 | Limits and methods of measurement of radio disturbance characteristics of information technology equipment | <input type="checkbox"/> EN 50091-2 | EMC requirements for uninterruptible power systems (UPS) |
| <input type="checkbox"/> DIN VDE 0855 Part 10 Part 15 | Called distribution systems, Equipment for receiving audio distribution from source and reception signals | | |
| <input checked="" type="checkbox"/> CE marking | |  | (EC conformity marking) |
- The manufacturer also declares the conformity of above mentioned product with the test report required safety standards in accordance with LVD 2004/109/EC**
- EN 60005 Safety requirements for mains operated household and similar general use
- EN 60950 Safety for information technology equipment including electrical business equipment
- EN 60335 Safety of household and similar electrical appliances
- EN 50091-1 (General and Safety requirements for uninterruptible power systems (UPS))

Manufacturer/importer

Signature: Timmy Huang

Date: Sept. 30, 2008

Name: Timmy Huang

(Stamp)

DECLARATION OF CONFORMITY

Per FCC Part 2 Section 2.1077(a)



Responsible Party Name: G.B.T. INC. (U.S.A.)

Address: 17358 Railroad Street

City of Industry, CA 91748

Phone/Fax No: (818) 854-9338/ (818) 854-9339

hereby declares that the product

Product Name: VGA Card

Model Number: GV-R4650C-1G1/
GV-R4650C-5121

Conforms to the following specifications:

FCC Part 15, Subpart B, Section 15.107(a) and Section 15.109

(a), Class B Digital Device

Supplementary Information:

This device complies with part 15 of the FCC Rules. Operation is subject to the following two conditions: (1) This device may not cause harmful and (2) this device must accept any interference received, including that may cause undesired operation.

Representative Person's Name: ERIC LU

Signature: ERIC LU

Date: Sept. 30, 2008

Table of Contents

1. Introduction	5
1.1. Features	5
1.2. Minimum System Requirements	5
2. Hardware Installation	6
2.1. Board Layout	6
2.2. Hardware Installation	8
3. Software Installation	10
3.1. Driver and Utility Installation	10
3.1.1. Driver Installation	10
3.1.2. GIGABYTE Gamer HUD Lite on Driver Disk	12
3.2. Taskbar Icon	14
3.3. Display Properties Pages	16
4. Troubleshooting Tips	31
5. Appendix	32
5.1. Resolutions and Color Depth Tables	32
5.2. Regulatory Statements	33

1. Introduction

1.1. Features

- Powered by **ATI Radeon™ HD 4670** Graphics Processing Unit (GPU) (For GV-R467D3-1GI/GV-R467D3-512I only)
- Powered by **ATI Radeon™ HD 4650** Graphics Processing Unit (GPU)(For GV-R465OC-1GI/GV-R465OC-512I only)
- Supports PCI Express 2.0
- Integrated with 1GB GDDR3 memory (For GV-R467D3-1GI only)
- Integrated with 1 GB GDDR2 memory (For GV-R465OC-1GI only)
- Integrated with 512 MB GDDR3 memory (For GV-R467D3-512I only)
- Integrated with 512 MB GDDR2 memory (For GV-R465OC-512I only)
- Supports DirectX 10.1
- Supports CrossFireX™
- Supports 1 Dual-Link DVI-I connector
- Supports 1 D-Sub connector
- Supports 1 HDMI connector

1.2. Minimum System Requirements

- **Hardware**
 - Intel® Pentium® 4/Core™ 2 or AMD Athlon™/Phenom™
 - 1 GB or more of system memory for best performance
 - Optical drive for software installation (CD-ROM or DVD-ROM drive)
 - A power supply that provides at least 400-watt is required. The power supply should be with a known brand and certified to conform to safety regulations. (For the list of certified power supplies, go to <http://ati.amd.com/certifiedpsu>.)
- **Operating System**
 - Windows® Vista
 - Windows® XP with Service Pack 2 (SP2)
 - Windows® XP Professional x64 Edition
- **CrossFireX™ Configuration**

If you are planning on using this graphics card as part of a CrossFireX system, the following is required:

- A CrossFireX certified motherboard with two PCI Express x16 slots and correct chipset driver
- Two GV-R467D3-1GI/GV-R467D3-512I/GV-R465OC-1GI/GV-R465OC-512I
- A power supply that provides at least 450-watt is required. The power supply should be with a known brand and certified to conform to safety regulations. (For the list of certified power supplies, go to <http://ati.amd.com/certifiedpsu>.)
- Two CrossFire bridge interconnect cables

2. Hardware Installation

2.1. Board Layout

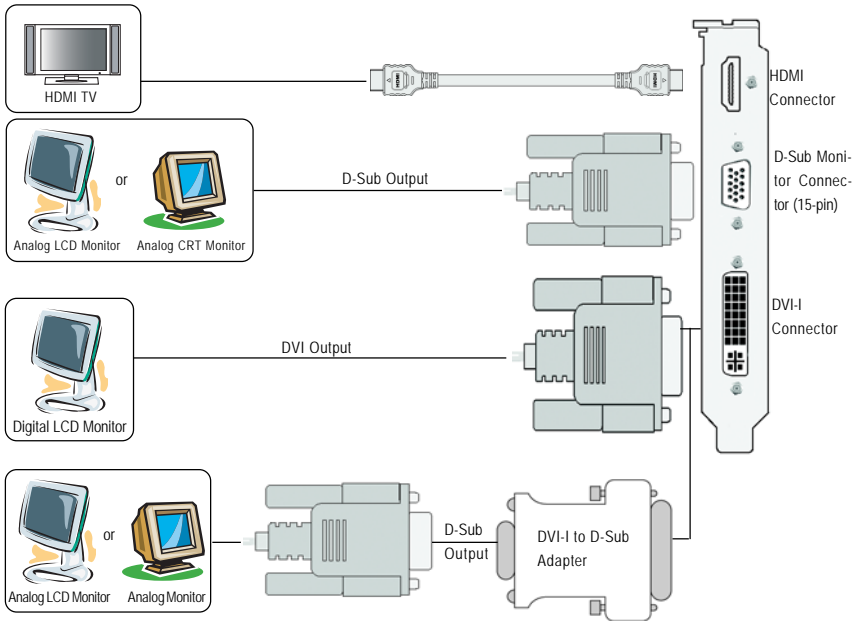
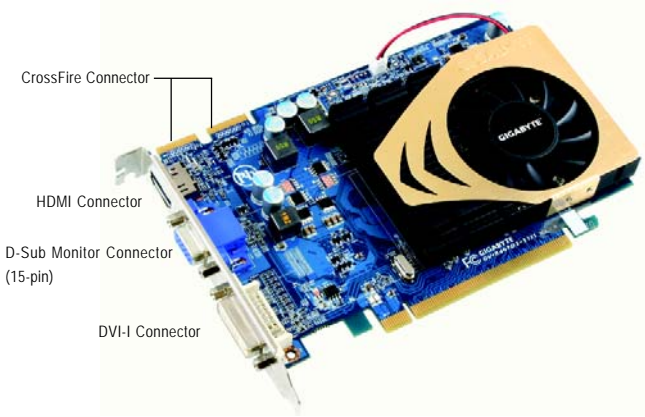



The entire Radeon HD 4670/4650 series support HDMI output which can handle both audio and video signals. However, audio output from the onboard audio controller or the external sound card will be disabled when HDMI output is activated.

If no need for HDMI output function, set the onboard audio controller or the external sound card to be the default Sound Playback device to obtain audio output from your system. For more details, refer to page 15.



Expansion cards contain very delicate Integrated Circuit (IC) chips. To protect them against damage from static electricity, you should follow some precautions whenever you work on your computer.

1. Turn off your computer and unplug power supply.
2. Use a grounded wrist strap before handling computer components. If you do not have one, touch both of your hands to a safely grounded object or to a metal object, such as the power supply case.
3. Place components on a grounded antistatic pad or on the bag that came with the components whenever the components are separated from the system.

The card contains sensitive electric components, which can be easily damaged by static electricity, so the card should be left in its original packing until it is installed.

Unpacking and installation should be done on a grounded anti-static mat. The operator should be wearing an anti-static wristband, grounded at the same point as the anti-static mat.

Inspect the card carton for obvious damage. Shipping and handling may cause damage to your card. Be sure there are no shipping and handling damages on the card before proceeding.

❗ **DO NOT APPLY POWER TO YOUR SYSTEM IF THE GRAPHICS CARD IS DAMAGED.**

❗ **In order to ensure that your graphics card can work correctly, please use official GIGABYTE BIOS only. Using non-official GIGABYTE BIOS might cause problem(s) on the graphics card.**

2.2. Hardware Installation

Now that you have prepared your computer, you are ready to install your graphics card.

Step 1.

Locate the PCI Express x16 slot. If necessary, remove the metal cover from this slot; then align your graphics card with the PCI Express x16 slot, and press it in firmly until the card is fully seated.



Make sure that the gold edge connector of the graphics card is securely inserted.

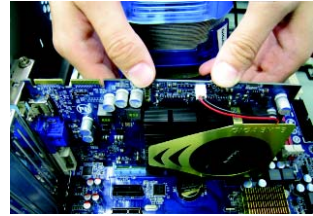

Step 2.

Replace the screw to fasten the card in place, and replace the computer cover.

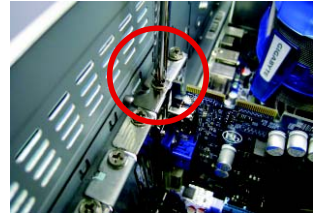

Step 3.

Plug the display cable into your card; then turn on the computer and monitor. To connect a D-Sub monitor to your graphics card, use the D-Sub connector. To connect a flat panel display to your graphics card, use the DVI-I connector. To connect an HDMI monitor to your graphics card, use the HDMI connector.



Connect an HDMI monitor



To HDMI Monitor



To D-Sub Monitor



To Flat Panel Display



Connect a D-Sub monitor



Connect a flat panel display

You are now ready to proceed with the installation of the graphics card driver. Please refer to next chapter for detailed instructions.

How to enable the ATI CrossFireX™ technology?

Step 1:

Install two CrossFireX graphics cards of the same chipset on a CrossFireX-supported motherboard and connect the graphics cards via two CrossFire bridge interconnect cables (Figure 1). Then users can enable the CrossFireX technology through the graphics card driver.

Two CrossFire bridge interconnect cables.

Two CrossFire graphics cards of the same type.
(Example: GV-RX195P256D-RH)

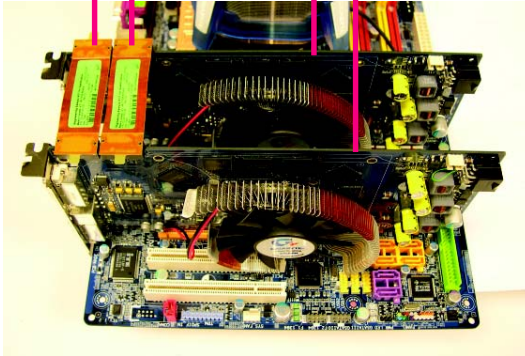

Figure 1

Step 2:

After installing graphics card driver in operating system, when an ATI CrossFireX configuration is detected for the first time by the ATI Catalyst display driver, ATI CrossFireX support is automatically enabled, and the best possible GPU combination is selected based on the hardware configuration. If ATI CrossFireX is not enabled, access the ATI Catalyst Control Center (please refer to Page 14). From the ATI Catalyst Control Center, enter the CrossFireX menu and assure to select the **Enable CrossFireX™** check box (Figure 2).



Figure 2

3. Software Installation

Notice the following guidelines before installing the drivers:

1. First make sure your system has installed DirectX 9 or later version.
2. Make sure your system has installed the appropriate motherboard drivers (for the motherboard drivers, please contact the motherboard manufacturer.)

3.1. Driver and Utility Installation

3.1.1. Driver Installation

After installing the operating system, insert the driver disk into your optical drive. The driver Autorun screen is automatically displayed which looks like that shown in the screen shot below. (If the driver Autorun screen does not appear automatically, go to My Computer, double-click the optical drive and execute the **setup.exe** program.)



Step 1:
Click the **Install Display Driver** item.

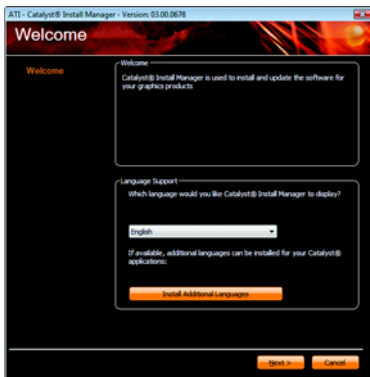

Step 2:
Select the displayed language and then click **Next**.



Step 3:
Click the **Install** button.



NOTE For software MPEG support in Windows XP, you must install DirectX first. Users who run Windows XP with Service Pack 2 or above do not need to install DirectX separately.

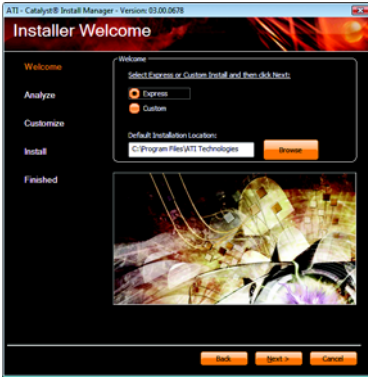

Step 4:
Click the **Express** or **Custom** icon and then click **Next**.

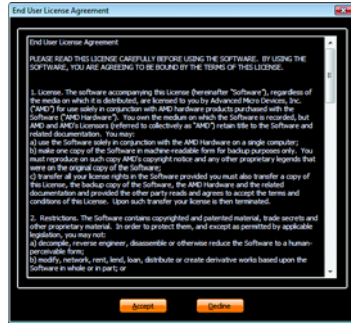

Step 5:
Click the **Accept** button.

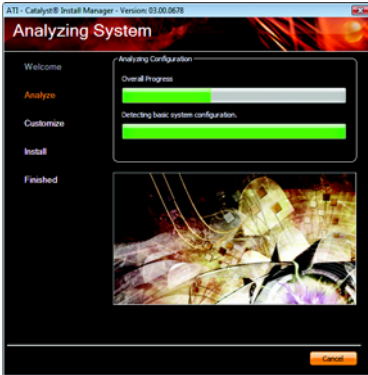

The system is installing the components.

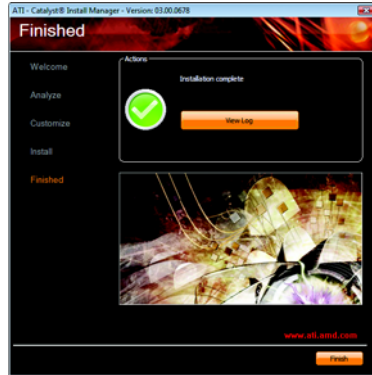

Step 6:
Click the **Finish** button to restart the computer.
Then the driver installation is completed.

3.1.2. GIGABYTE Gamer HUD Lite on Driver Disk



Step 1:
Click the GIGABYTE Gamer HUD Lite item.

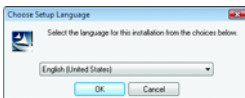

Step 2:
Choose the language for the installation and click the OK button.

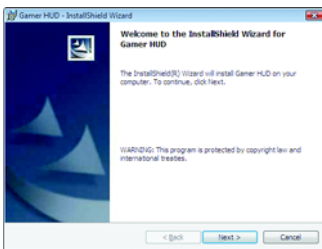

Step 3:
Click the Next button.

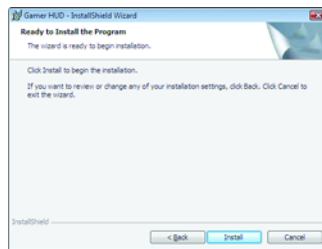

Step 4:
Click the Install button.

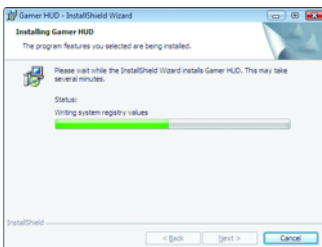

The system is installing the components.

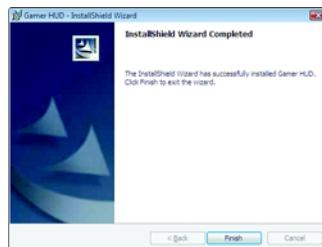

Step 5:
Click the Finish button. Then the installation of the GIGABYTE Gamer HUD Lite is completed.

GIGABYTE Gamer HUD Lite

The GIGABYTE Gamer HUD Lite allows you to adjust the the working frequency of the GPU and video memory.

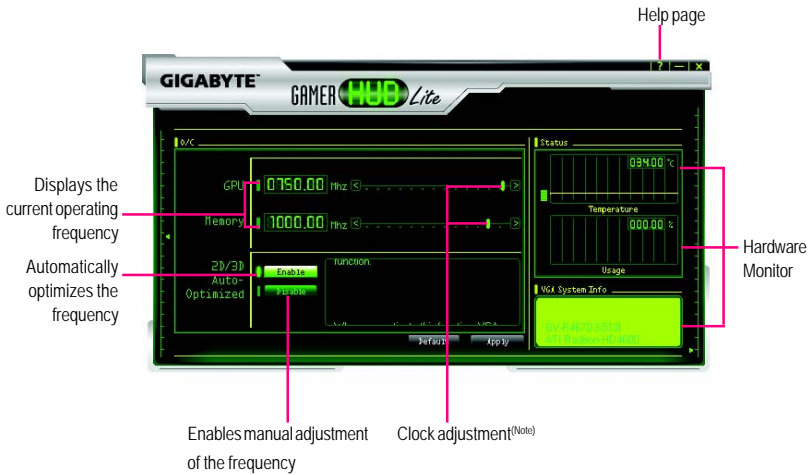

Button	Function
Default ^(Note)	Allows you to load the default settings
Apply ^(Note)	Allows you to save the values you adjust
Enable	Lets the utility optimize the GPU/memory frequency settings
Disable	Allows you to manually configure the GPU/Memory frequency settings
Hardware Monitor	Displays the GPU usage and temperature, the GPU usage/thermal curve, and your graphics card information
?	Opens Help page



Incorrectly doing overclock/overvoltage may result in damage to your system and reduce the useful life of the system components.

(Note) This item is configurable only if 2D/3D Auto-Optimized is set to Disable.

3.2. Taskbar Icon

After installation of the display driver, you will find an ATI  icon in the notification area. Right-click the icon to enter the **ATI Catalyst Control Center**. The **ATI Catalyst Control Center** is used to configure all your graphics card settings.

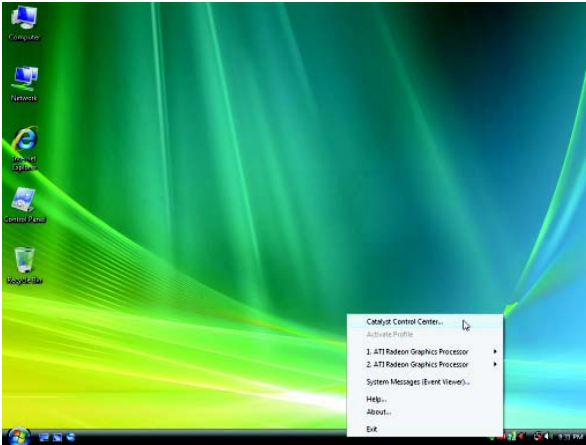

Right-click the ATI icon to enter the **ATI Catalyst Control Center**.

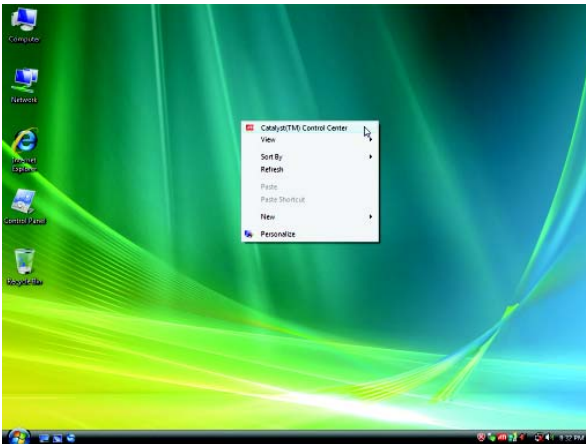

Or you can right-click on the desktop and select **Catalyst(TM) Control Center**.

Configuring Audio Output

Configure the default audio output device based upon your needs.

Step 1:

Go to Start > Control Panel > Hardware and Sound > Manage audio devices.



Figure 1

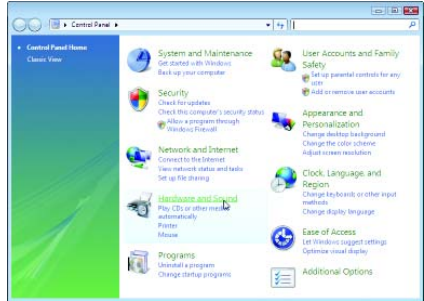

Figure 2



Figure 3

Step 2:

In the **Manage audio devices** dialog box, click the **Playback** tab.

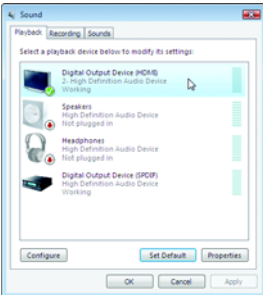

Using the picture to the left as the example, to set HDMI audio to be the default Sound Playback device, select **Digital Output Device (HDMI)**. Otherwise, select **Digital Output Device (SPDIF)**, which is the onboard audio controller.

3.3. Display Properties Pages

Display Settings (Resolutions and Color Quality for Windows)

To access **Display Settings** page, right-click on desktop and select **Personalize**, then the Personalization windows will show up. Select **Display Settings** to adjust the screen resolution and color quality settings.

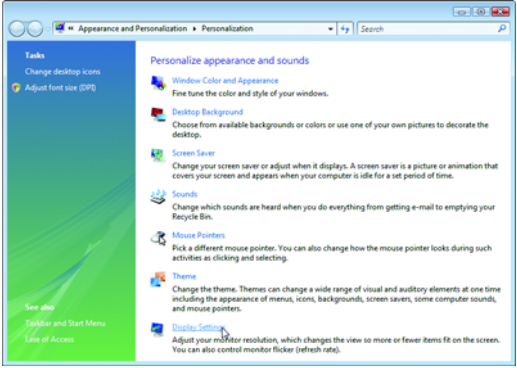

- You can move the slider to change the resolution.
- You can click the item to change the colors quality.
- Click the **Advanced** button for advanced settings.

Display Matrix	Model	GV-R467D3-1G(512)	GV-R465OC-1G(512)
	CRT+DVI	Yes	Yes
	CRT+CRT (Note 1)	Yes	Yes
	DVI+DVI (Note 2)	Yes	Yes
	HDMI+DVI	Yes	Yes
	HDMI+CRT	Yes	Yes

(Note 1) By a DVI-to-D-Sub adapter.

(Note 2) By a D-Sub-to-DVI adapter.

ATI Catalyst® Control Center Basic View :

The Basic View is the default view when ATI Catalyst Control Center is launched for the first time. This interface provides access to the basic settings and advanced features of your ATI graphics products. You can switch between Basic View and Advanced View at any time.

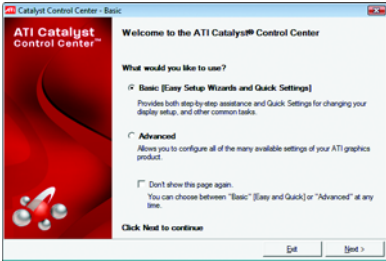

To access more settings in Basic View, click **Basic**, and then click **Next**.

Easy Setup Wizards:

Choose a wizard from the central list and click **Go** for step-by-step assistance.

■ Avivo Video Converter

This wizard assists you to convert videos from one file format to another.

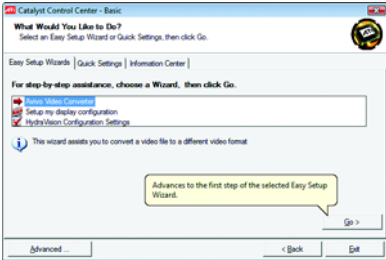

Step 1:
Select **Avivo Video Converter**, then click **Go**.

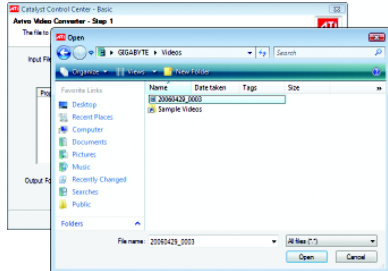

Step 2:
Select the video file to be converted.

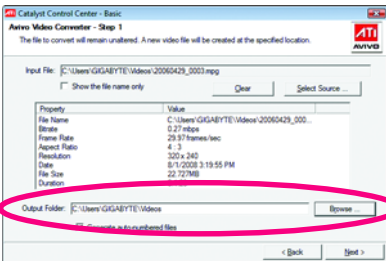

Step 3:
In the **Output Folder** area, select the destination folder where the new file will be located. Click **Next**.

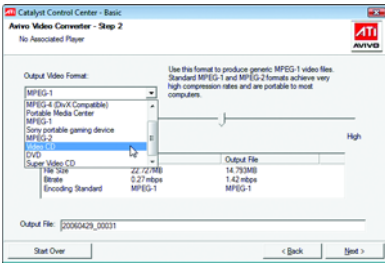

Step 4:

In the **Output Video Format** list, select a file format for the new file. If you wish to change the name of the new file, enter the new name in the **Output File** area. Finally, click **Next** to start file conversion.

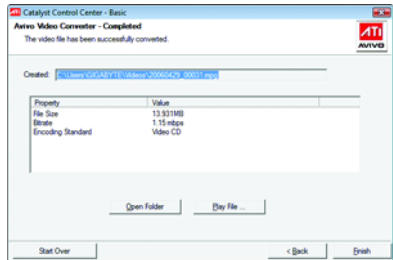

The video file has been successfully converted.

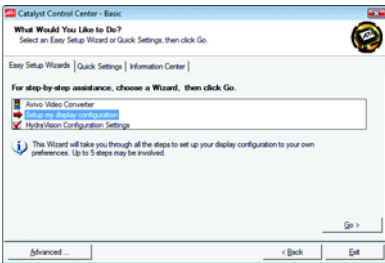

■ Setup my display configuration

This wizard allows you to configure display setting for desktop viewing.

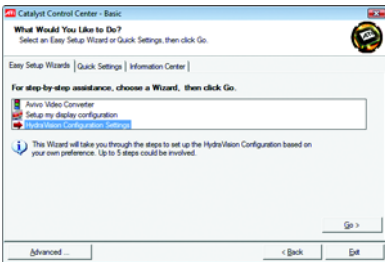

■ HydraVision Configuration Settings

This wizard will take you to set up the HydraVision Configuration based on your own preference.

Quick Settings:

The Quick Settings page provides access to three main settings.

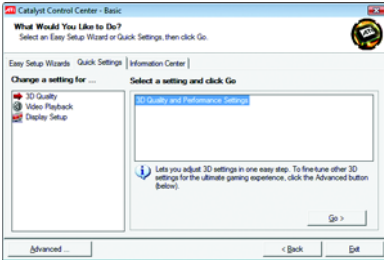

■ 3D Quality

3D Performance and Quality Settings allows your 3D games and applications to get faster performance and better quality with a more balanced setting.

■ Video Playback

Use this option to optimize video playback in different room environment or to select how video playback appears on the second display.

■ Display Setup

This option allows you to configure your desktop, including changing desktop resolution and desktop mode, setting up extended desktop (requires more than one display), and rotating desktop image to match new display orientation.

Information Center:

The Information Center page in Basic and Advanced View provides hardware and software information about the installed graphics card.

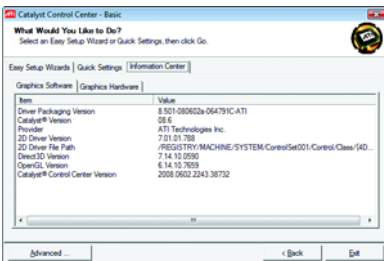

■ Graphics Software

Provides software information including driver version, CATALYST version, Direct 3D version and so on.

■ Graphics Hardware

Provides hardware information including graphics chipset, BIOS version, memory size, core clock and so on.

ATI Catalyst Control Center Advanced View

The Advanced page allows you to configure all of the many available settings of your ATI graphics card.

View Properties:

The CATALYST Control Center dashboard supports three types of views: Basic View/ Advanced View/ Custom View.



■ Basic View

The Basic view is the default view when CATALYST Control Center is launched for the first time. Refer to the previous pages for details.

■ Advanced View

The Advanced view provides access to the advanced features on each page. The left navigation pane displays a tree view that lists all the advanced features. The Advanced view is recommended for experienced users.

■ Custom View

The Custom view allows you to display only the features you choose in the left navigation pane. The Custom view is recommended for experienced users who want to expose only the features they adjust most often or that their 3D application supports.

Hotkeys Properties:

The Hotkeys Manager allows you to create shortcut key combinations to quickly perform tasks such as changing a graphics setting or opening an application. A Hotkey is a combination of a modifier key or keys, such as Ctrl, Alt, or Shift, and any letter from the alphabet.



Profiles Properties:

You can use profiles to create customized environments for your desktop, video, and 3D applications. Define and save your own personal video settings that can be quickly activated manually, through a Hotkey, or by file association.

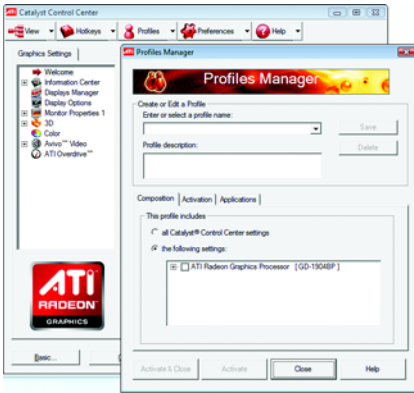

Note:

A profile applies to a specific graphics card. If there is more than one graphics card installed in your computer, you need to select the appropriate card before creating, loading, or activating a Profile.

Preferences Properties:

The Preferences page helps to restore defaults, change skins, and update the Catalyst Control Center. The Catalyst Control Center Preferences page contains the following options:



- Always on Top
- Hide Tooltips
- Hide Toolbar Text
- Hide Splash Screen
- Enable System Tray Menu
- Select a Language ...
- Select a Skin ...
- Restore Factory Defaults ...

Help Properties:

The Catalyst Control Center Help feature allows you to access the comprehensive online help, register your product, or generate a problem report should you require technical support.



The Catalyst Control Center Help feature offers the following options:

- Help for this Page
- Help Contents ...
- Go to ATI.com
- About Catalyst Control Center ...

Displays Manager:

Displays Manager is the central location for configuring your display devices and arranging your desktop. Use Displays Manager to change your display setup and arrange your desktop in a multi-monitor environment.



Note:

The stretch vertically and horizontally options are not supported on systems running Windows Vista.

Display Options:

The Display Options aspect gives you additional control to optimize performance of OpenGL and Direct 3D applications. Choose one of the **Display Detection Option** to prevent screen flicker when detecting a display.



Note:

On systems Windows XP, this page will show up the **3D Refresh Rate Override** item. Use **3D Refresh Rate Override** to set a refresh rate of your choice when a full-screen application or game has a default refresh rate that is lower than optimal.

Monitor Properties 1:

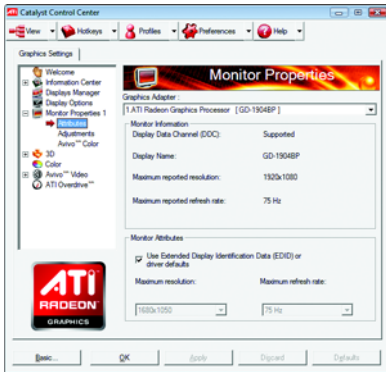

- Attributes

Monitor Attributes provides information about the attached monitor. You can also enable Extended Display Identification Data (EDID). EDID uses the information provided by the attached monitor to determine the limits for the resolution and refresh rate.



- Adjustments

Use Monitor Adjustments to resize and reposition the computer desktop on your monitor's display screen. You can also adjust the horizontal and vertical sync or enable composite sync.

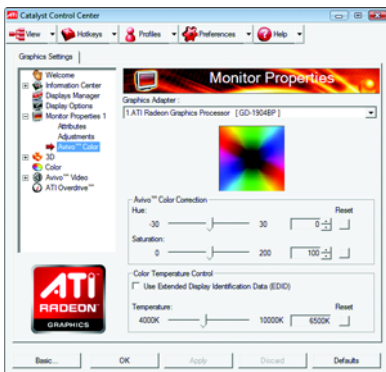

- Avivo™ Color

Use Avivo™ Color for ATI graphics cards that support per-display color settings. Independently set the hue, saturation, and temperature for each attached and enabled display.

3D:

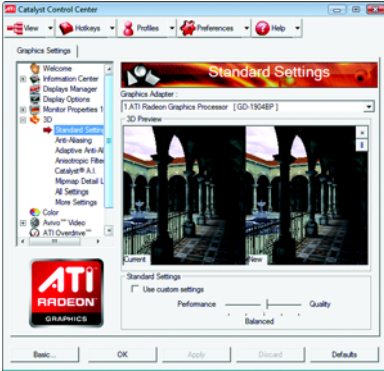

■ Standard Settings

The Standard Settings page provides access to a universal slider control where you can simultaneously adjust all of the standard 3D settings for any type of 3D application. The slider enables you to adjust for overall system performance, overall 3D image quality, or a balance between the two. This page is useful when you are not aware of which type of 3D settings your application uses, or when you want to use an overall adjustment control that rapidly configures your application.



■ Anti-Aliasing

Anti-Aliasing (AA) is a rendering technique designed to remove jagged edges, shimmering, and pixelation problems that are common in rendered 3D images. Rather than determining the color to display for each pixel by sampling a single location at the pixel's center, anti-aliasing samples multiple locations within each pixel and blends the results together to produce the final color.

Anti-Aliasing can be set to favor either system processing performance or image quality, or the application can decide:

- Setting for performance is best used when the 3D image is animated and smooth motion is the most important consideration.
- Setting for quality is best used when highly detailed and realistic 3D objects is the most important consideration.
- If you are unsure of how to configure anti-aliasing, use the Use application settings option. Your display will automatically adjust to the application's requirements.



■ Adaptive Anti-Aliasing

Adaptive anti-aliasing is a technique that applies a combination of multi-sampling (MSAA) and super-sampling (SSAA) on 3D objects to improve edge smoothness and fine detail.

This feature renders 3D objects containing transparencies more realistic, providing exceptional levels of image quality while maintaining performance.



■ Anisotropic Filtering

Anisotropic Filtering is a technique that preserves detail on surfaces that have three-dimensional perspective and fade away into the background. It works best when used in conjunction with Mipmapping. Anisotropic Filtering can be set to favor either an increase in system processing performance or improved image quality:

- Setting for performance is best used with applications that display objects with smooth, simple surfaces, like those seen in CAD applications.
- Setting for quality is best used with applications that display highly detailed scenes, backgrounds, and textured objects, like those seen in 3D games.
- If you are unsure how to configure anisotropic filtering, use the Use application settings option. Your display will automatically adjust to the application's requirements.



■ CATALYST® A.I.

Catalyst® A.I. makes use of ATI's new texture analyzer technology to optimize performance in 3D applications while maintaining or even improving image quality. It analyzes individual textures as they are loaded to determine the best and fastest way to display them.



■ Mipmap Detail Level

Mipmapping is a texturing technique that preserves the detail on a 3D object's surface as it moves into the background. A series of low- and high-resolution texture maps are stored in memory and selectively used to create the object's surface, depending on what level of detail is needed.

Mipmap detail level can be set to favor either an increase in system processing performance or improved image quality:

- Setting for performance is best used when the 3D image is animated and smoothness of motion is the most important consideration.
- Setting for quality is best used when high surface detail is required, especially if the animated object rotates or moves into the background.



■ All Settings

The All Settings page combines all of the principal 3D features onto a single page, without any preview window, allowing for quick access and adjustment. This page is useful when it is not necessary to preview the adjusted settings because the effect is already known or understood.



■ More Settings

Use the More Settings dialog to select settings for the Direct 3D and OpenGL Application Programmable Interfaces (API). These settings are provided for resolving certain incompatibilities within 3D applications that use one of these APIs. Use this dialog when you know which type of API (Direct 3D or OpenGL your 3D application uses, and you want to select a particular API-specific feature. If you are not sure which API your 3D application uses, consult the documentation of your 3D application.

Note:

The Alternate Pixel center Direct 3D setting is not supported on systems running Windows Vista. This setting corrected a corruption problem that occurred with some older games that should not occur with modern games.

Color:

Adjust the overall richness of color by using the Gamma control. To adjust the overall brightness use the Brightness control, and the overall contrast use the Contrast control.

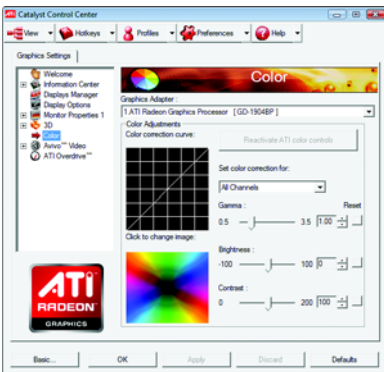

Avivo™ Video:



- Presets

To quickly adjust your video settings choose one of the video presets.

Note:

These settings will only affect applications with video overlay support.



- Basic Color

Use the Avivo Color: Basic option to manually set Gamma, Brightness, Contrast, Saturation, and Tint for video playback.

Note:

Certain video formats do not support these adjustments. These settings will only affect applications with video overlay support.



- Advanced Color

Use the Advanced Color page to fine tune the color of standard definition video (720x480) to make the color more or less vibrant and to remove excess red from skin tones. You can preview your changes before applying them.

Note:

This page is only for Windows Vista.

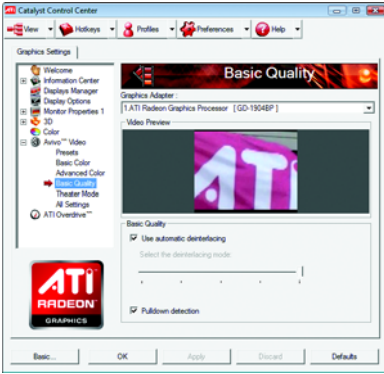

■ Basic Quality

You can control the deinterlacing settings by checking the **Use automatic deinterlacing** item. The bar determines how the two interlaced video fields are converted into a non-interlaced form.

Note:

These settings will only affect applications with video overlay support.



■ Theater Mode

Use Theater Mode to change the way you view streaming video.

Note:

- These settings will only affect applications with video overlay support. Extended Desktop Mode is not supported on systems running Windows Vista.
- This item will be available when you connect two monitors.



■ All Settings

The All Settings page combines all of the principal Video features onto a single page, without any preview window, allowing quick access and adjustment. This page is useful when it is not necessary to preview the adjusted settings because the effect is already known or understood.

Note:

These settings will only affect applications with video overlay support.

ATI Overdrive:

Use Overdrive to maximize your viewing experience by dynamically and safely overclocking the graphics processor and memory. Use the Automated clock configuration utility to obtain the ATI recommended speeds for the graphics processor clock and video memory clock. Alternatively, manually set these speeds to meet your specific requirements. Finally, Overdrive can be configured to run when the

computer is booted or only when running 3D applications.
Note:

If your computer cannot restart after setting a higher clock speed, press and hold the <Shift> key during system start-up until you hear three beeps. Once your computer has full booted, disable Preserve ATI Overdrive settings at logon.



CrossFireX™:

CrossFireX delivers exceptional performance on a single display by combining the processing power of two or more Graphics Processing Units (GPUs).

■ Configure

When an ATI CrossFireX configuration is detected for the first time by the ATI Catalyst display driver, ATI CrossFireX support is automatically enabled. If ATI CrossFireX is not enabled, select the **Enable CrossFireX™** check box.



■ Diagnostics

Use this page to determine whether your ATI CrossFireX configurations are configured properly and functioning optimally. You can also use the page to view performance issues and suggested solutions specific to a particular configuration.
Note:

This page is only for ATI CrossFireX configuration.



4. Troubleshooting Tips

The following troubleshooting tips may help if you experience problems. Contact your dealer or GIGABYTE for more advanced troubleshooting information.

- Check that the card is seated properly in the PCI Express x16 slot.
- Ensure that the display cable is securely fastened to the card's display connector.
- Make sure that the monitor and computer are plugged in and receiving power.
- If necessary, disable any built-in graphics capabilities on your motherboard. For more information, consult your computer's manual or manufacturer.
(NOTE: Some manufacturers do not allow the built-in graphics to be disabled or to become the secondary display.)
- Make sure you selected the appropriate display device and graphics card when you install the graphics driver.
- Restart your computer.
Press <F8> on your keyboard after system starts up. When the Windows Advanced Options Menu appears, select Safe Mode and press <Enter>.
After getting into Safe Mode, in Device Manager check whether the driver for the graphics card is correct.
- For more assistance, use the Troubleshooting Guide located in the Windows Help or contact your computer manufacturer.



If necessary, adjust your monitor's setting using monitor's adjust panel to make the screen look focused, crisp, and sharp. (Please refer to the monitor's manual.)

5. Appendix

5.1. Resolutions and Color Depth Tables

Radeon™ HD 4670/4650 Series 2D Single Display Modes

Display Screen Resolution	Refresh Rate (Hz)	Color Depth (bpp)		
		8bpp(256 color) Standard mode	16bpp(65K color) High mode	32bpp(16.7M) True mode
640 x 480	200	✓	✓	✓
800 x 600	200	✓	✓	✓
1024 x 768	200	✓	✓	✓
1152 x 864	100	✓	✓	✓
1280 x 768	85	✓	✓	✓
1280 x 960	160	✓	✓	✓
1280 x 1024	120	✓	✓	✓
1440 x 900	60	✓	✓	✓
1600 x 1200	100	✓	✓	✓
1680 x 1050	100	✓	✓	✓
1792 x 1344	85	✓	✓	✓
1800 x 1440	70	✓	✓	✓
1856 x 1392	75	✓	✓	✓
1920 x 1080	75	✓	✓	✓
1920 x 1200	85	✓	✓	✓
1920 x 1400	75	✓	✓	✓
2048 x 1536	66	✓	✓	✓

Radeon™ HD 4670/4650 Series HDTV Display Modes

	Display Screen Resolution	Maximum Refresh Rate (Hz)
480i	640 x 480	30
	704 x 480	30
	720 x 480	30
480p	640 x 480	60
	704 x 480	60
	720 x 480	60
	856 x 480	60
720p	960 x 720	60
	1280 x 720	60
1080i	1920 x 1080	30

* The tables are for reference only. The actual resolutions supported depend on the monitor you use.

5.2. Regulatory Statements

Regulatory Notices

This document must not be copied without our written permission, and the contents there of must not be imparted to a third party nor be used for any unauthorized purpose. Contravention will be prosecuted. We believe that the information contained herein was accurate in all respects at the time of printing. GIGABYTE cannot, however, assume any responsibility for errors or omissions in this text. Also note that the information in this document is subject to change without notice and should not be construed as a commitment by GIGABYTE.

Our Commitment to Preserving the Environment

In addition to high-efficiency performance, all GIGABYTE motherboards fulfill European Union regulations for RoHS (Restriction of Certain Hazardous Substances in Electrical and Electronic Equipment) and WEEE (Waste Electrical and Electronic Equipment) environmental directives, as well as most major worldwide safety requirements. To prevent releases of harmful substances into the environment and to maximize the use of our natural resources, GIGABYTE provides the following information on how you can responsibly recycle or reuse most of the materials in your "end of life" product.

Restriction of Hazardous Substances (RoHS) Directive Statement

GIGABYTE products have not intended to add and safe from hazardous substances (Cd, Pb, Hg, Cr+6, PBDE and PBB). The parts and components have been carefully selected to meet RoHS requirement. Moreover, we at GIGABYTE are continuing our efforts to develop products that do not use internationally banned toxic chemicals.

Waste Electrical & Electronic Equipment (WEEE) Directive Statement

GIGABYTE will fulfill the national laws as interpreted from the 2002/96/EC WEEE (Waste Electrical and Electronic Equipment) directive. The WEEE Directive specifies the treatment, collection, recycling and disposal of electric and electronic devices and their components. Under the Directive, used equipment must be marked, collected separately, and disposed of properly.

WEEE Symbol Statement



The symbol shown below is on the product or on its packaging, which indicates that this product must not be disposed of with other waste. Instead, the device should be taken to the waste collection centers for activation of the treatment, collection, recycling and disposal procedure. The separate collection and recycling of your waste equipment at the time of disposal will help to conserve natural resources and ensure that it is recycled in a manner that protects human health and the environment. For more information about where you can drop off your waste equipment for recycling, please contact your local government office, your household waste disposal service or where you purchased the product for details of environmentally safe recycling.

- When your electrical or electronic equipment is no longer useful to you, "take it back" to your local or regional waste collection administration for recycling.
- If you need further assistance in recycling, reusing in your "end of life" product, you may contact us at the Customer Care number listed in your product's user's manual and we will be glad to help you with your effort.

Finally, we suggest that you practice other environmentally friendly actions by understanding and using the energy-saving features of this product (where applicable), recycling the inner and outer packaging (including shipping containers) this product was delivered in, and by disposing of or recycling used batteries properly. With your help, we can reduce the amount of natural resources needed to produce electrical and electronic equipment, minimize the use of landfills for the disposal of "end of life" products, and generally improve our quality of life by ensuring that potentially hazardous substances are not released into the environment and are disposed of properly.

China Restriction of Hazardous Substances Table

The following table is supplied in compliance with China's Restriction of Hazardous Substances (China RoHS) requirements:



关于符合中国《电子信息产品污染控制管理办法》的声明
 Management Methods on Control of Pollution from Electronic Information Products
 (China RoHS Declaration)

产品中有毒有害物质或元素的名称及含量
 Hazardous Substances Table

部件名称 (Parts)	有毒有害物质或元素 (Hazardous Substances)					
	铅 (Pb)	汞 (Hg)	镉 (Cd)	六价铬 (Cr (VI))	多溴联苯 (PBB)	多溴二苯醚 (PBDE)
PCB板 PCB	○	○	○	○	○	○
结构件及风扇 Mechanical parts and Fan	×	○	○	○	○	○
芯片及其他主动零件 Chip and other Active components	×	○	○	○	○	○
连接器 Connectors	×	○	○	○	○	○
被动电子元件 Passive Components	×	○	○	○	○	○
线材 Cables	○	○	○	○	○	○
焊接金属 Soldering metal	○	○	○	○	○	○
助焊剂、散热膏、标签及其他耗材 Flux, Solder Paste, Label and other Consumable Materials	○	○	○	○	○	○
○:表示该有毒有害物质在该部件所有均质材料中的含量均在SJ/T11363-2006标准规定的限量要求以下。 Indicates that this hazardous substance contained in all homogenous materials of this part is below the limit requirement SJ/T 11363-2006						
×:表示该有毒有害物质至少在该部件的某一均质材料中的含量超出SJ/T11363-2006标准规定的限量要求。 Indicates that this hazardous substance contained in at least one of the homogenous materials of this part is above the limit requirement in SJ/T 11363-2006						
对销售之日的所发售产品, 本表显示我公司供应链的电子信息产品可能包含这些物质。注意: 在所售产品中可能会也可能不会含有所有列出的部件。 This table shows where these substances may be found in the supply chain of our electronic information products, as of the date of the sale of the enclosed products. Note that some of the component types listed above may or may not be a part of the enclosed product.						