

Declaration of Conformity

We, Manufacturer/Importer
(full address)

G.B.T. Technology Trading GmbH
Ausschlagler Weg 41, 1F 20537 Hamburg, Germany

declare that the product
(description of the apparatus, system, installation to which it refers)

VGA Card

GV-RX195X512VB-RH

is in conformity with
(reference to the specification under which conformity is declared)
in accordance with 89/336 EEC-EMC Directive

- | | | | |
|---|--|---|---|
| <input type="checkbox"/> EN 55011 | Limits and methods of measurement of radio disturbance characteristics of industrial, scientific and medical (ISM) high frequency equipment | <input checked="" type="checkbox"/> EN 61000-3-2 | Disturbances in supply systems caused |
| <input type="checkbox"/> EN 55013 | Limits and methods of measurement of radio disturbance characteristics of broadcast receivers and associated equipment | <input checked="" type="checkbox"/> EN 61000-3-3 | Disturbances in supply systems caused by household appliances and similar electrical equipment "Voltage fluctuations" |
| <input type="checkbox"/> EN 55014-1 | Limits and methods of measurement of radio disturbance characteristics of household electrical appliances, portable tools and similar electrical apparatus | <input type="checkbox"/> EN 55024 | Information Technology equipment-Immunity characteristics-Limits and methods of measurement |
| <input type="checkbox"/> EN 55015 | Limits and methods of measurement of radio disturbance characteristics of fluorescent lamps and luminaires | <input type="checkbox"/> EN 50082-1 | Generic immunity standard Part 1: Residual, commercial and light industry |
| <input type="checkbox"/> EN 55020 | Immunity from radio interference of broadcast receivers and associated equipment | <input type="checkbox"/> EN 50082-2 | Generic immunity standard Part 2: Industrial environment |
| <input checked="" type="checkbox"/> EN 55022 | Limits and methods of measurement of radio disturbance characteristics of information technology equipment | <input type="checkbox"/> EN 55014-2 | Immunity requirements for household appliances tools and similar apparatus |
| <input type="checkbox"/> DIN VDE 0855 | Cabled distribution systems; Equipment for receiving and/or distribution from sound and television signals | <input type="checkbox"/> EN 50091- 2 | EMC requirements for uninterruptible power systems (UPS) |
| <input type="checkbox"/> part 10 | | | |
| <input type="checkbox"/> part 12 | | | |

CE marking



(EC conformity marking)

The manufacturer also declares the conformity of above mentioned product with the actual required safety standards in accordance with LVD 73/23 EEC

- | | | | |
|--|---|--|---|
| <input type="checkbox"/> EN 60065 | Safety requirements for mains operated electronic and related apparatus for household and similar general use | <input type="checkbox"/> EN 60950 | Safety for information technology equipment including electrical business equipment |
| <input type="checkbox"/> EN 60335 | Safety of household and similar electrical appliances | <input type="checkbox"/> EN 50091-1 | General and Safety requirements for uninterruptible power systems (UPS) |

Manufacturer/Importer

Signature : Timmy Huang

(Stamp)

Date : Sept. 7, 2006

Name : Timmy Huang

DECLARATION OF CONFORMITY

Per FCC Part 2 Section 2.1077(a)



Responsible Party Name: G.B.T. INC. (U.S.A.)

**Address: 17358 Railroad Street
City of Industry, CA 91748**

Phone/Fax No: (818) 854-9338/ (818) 854-9339

hereby declares that the product

Product Name: VGA Card

Model Number: GV-RX195X512VB-RH

Conforms to the following specifications:

FCC Part 15, Subpart B, Section 15.107(a) and Section 15.109
(a), Class B Digital Device

Supplementary Information:

This device complies with part 15 of the FCC Rules. Operation is subject to the following two conditions: (1) This device may not cause harmful and (2) this device must accept any interference received, including that may cause undesired operation.

Representative Person's Name: ERIC LU

Signature: *Eric Lu*

Date: Sept. 7, 2006

GV-RX195X512VB-RH

Radeon X1950 XTX Graphics Accelerator

User's Manual

Rev. 101

12MD-RX195X5R-101R



* The WEEE marking on the product indicates this product must not be disposed of with user's other household waste and must be handed over to a designated collection point for the recycling of waste electrical and electronic equipment!!

* The WEEE marking applies only in European Union's member states.

Copyright

© 2006 GIGABYTE TECHNOLOGY CO., LTD

Copyright by **GIGA-BYTE TECHNOLOGY CO., LTD. ("GBT")**. No part of this manual may be reproduced or transmitted in any form without the expressed, written permission of **GBT**.

Trademarks

Third-party brands and names are the property of their respective owners.

Notice

Please do not remove any labels on VGA card, this may void the warranty of this VGA card

Due to rapid change in technology, some of the specifications might be out of date before publication of this booklet.

The author assumes no responsibility for any errors or omissions that may appear in this document nor does the author make a commitment to update the information contained herein.

Macrovision corporation product notice:

This product incorporates copyright protection technology that is protected by U.S. patents and other intellectual property rights.

Use of this copyright protection technology must be authorized by Macrovision, and is intended for home and other limited viewing uses only unless otherwise authorized by Macrovision. Reverse engineering or disassembly is prohibited.

Table of Contents

1. Introduction	3
1.1. Features	3
1.2. Minimum System Requirements	3
2. Hardware Installation	4
2.1. Board Layout	4
2.2. Hardware Installation	6
3. Software Installation	9
3.1. Windows® XP Driver and Utilities Installation	9
3.1.1. Operating System Requirement	9
3.1.2. DirectX Installation	10
3.1.3. Driver Installation	11
3.1.4. Utilities on Driver CD	13
3.1.5. Video In Introduction	14
3.1.6. Taskbar Icon	17
3.1.7. Display Properties pages	18
3.2. Windows® 2000 Driver Installation	35
4. Troubleshooting Tips	36
5. Appendix	37
Resolutions and Color Depth Table (In Windows® XP)	37

1. Introduction

1.1. Features

- Powered by **ATi Radeon X1950 XTX** Graphics Processing Unit (GPU)
- Supports PCI Express x16
- Integrated with 512 MB GDDR4 memory
- Supports DirectX 9.0c
- Supports CrossFire™
- Supports AV / S-Video and HDTV output
- Supports AV / S-Video input
- Provides TV-Out connector
- Provides 2 DVI-I connectors
- Supports D-sub connector (by adapter)

1.2. Minimum System Requirements

- **Hardware**
 - Intel® Pentium® 4 or AMD Athlon™
 - 512 MB of system memory ; 1 GB or more for best performance
 - Optical drive for software installation (CD-ROM or DVD-ROM drive)
 - A power supply with 450-watt or above and 30A current on 12V rail is recommended
- **Operating System**
 - Windows® XP with Service Pack 2 (SP2)
 - Windows® XP Professional x64 Edition
 - Windows® 2000

- **CrossFire™ Configuration**

If you are planning on using this graphics card as part of a CrossFire™ system, the following is required:

- A CrossFire™ certified motherboard with two PCI Express x16 slots and correct PCIe chipset driver
- A X1950 CrossFire™ edition master card
- A power supply with 550-watt or above and 38A current on 12V rail is recommended

2. Hardware Installation

2.1. Board Layout

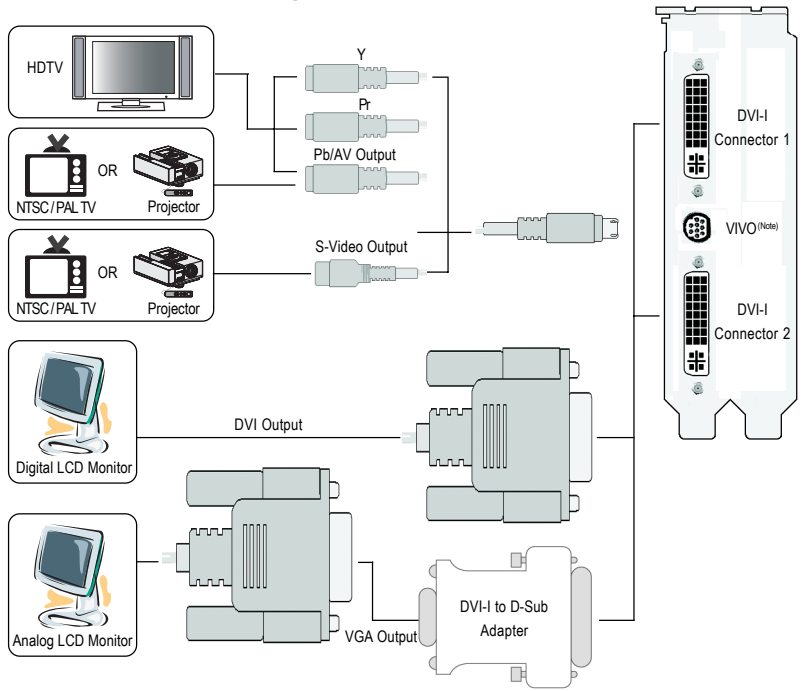
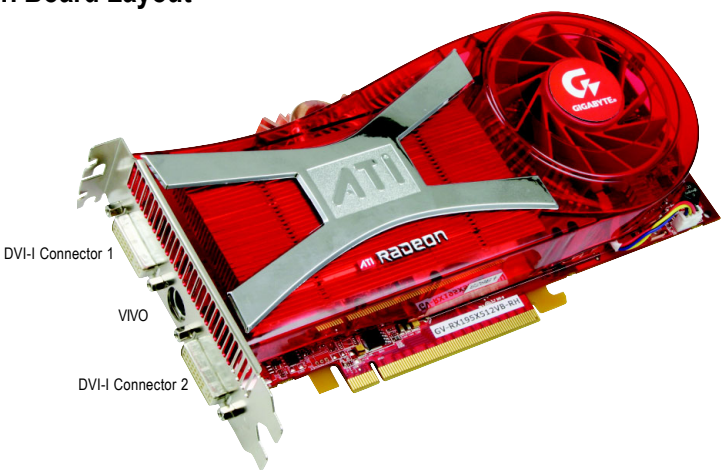

(Note) Please refer to page 14 about Video In introduction.



Expansion cards contain very delicate Integrated Circuit (IC) chips. To protect them against damage from static electricity, you should follow some precautions whenever you work on your computer.

1. Turn off your computer and unplug power supply.
2. Use a grounded wrist strap before handling computer components. If you do not have one, touch both of your hands to a safely grounded object or to a metal object, such as the power supply case.
3. Place components on a grounded antistatic pad or on the bag that came with the components whenever the components are separated from the system.

The card contains sensitive electric components, which can be easily damaged by static electricity, so the card should be left in its original packing until it is installed.

Unpacking and installation should be done on a grounded anti-static mat. The operator should be wearing an anti-static wristband, grounded at the same point as the anti-static mat.

Inspect the card carton for obvious damage. Shipping and handling may cause damage to your card. Be sure there are no shipping and handling damages on the card before proceeding.

⚡ **DO NOT APPLY POWER TO YOUR SYSTEM IF IT HAS BEEN DAMAGED ON THE CARD.**

⚡ **In order to ensure your graphics card working correctly, please use official Gigabyte BIOS only. Use none official Gigabyte BIOS might cause problem on the graphics card.**

2.2. Hardware Installation

Installing Your graphics card.

Now that you have prepared your computer, you are ready to install your graphics accelerator card.

To remove the existing graphics card:

1. Power off the computer and monitor, then disconnect the display cable from the back of your computer.



2. Remove the computer cover. If necessary, consult your computer's manual for help in removing the cover.

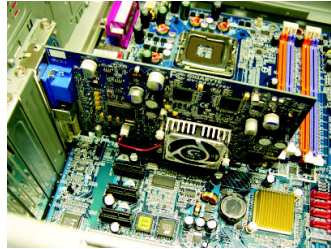

3. Remove any existing graphics card from your computer.

Or, if your computer has any on-board graphics capability, you may need to disable it on the motherboard. For more information, please see you computer documentation.

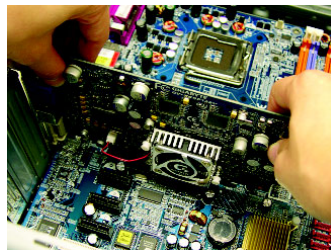

To install your new graphics card:

1. Locate the PCI Express x16 slot. If necessary, remove the metal cover from this slot; then align your graphics card with the PCI Express x16 slot, and press it in firmly until the card is fully seated.

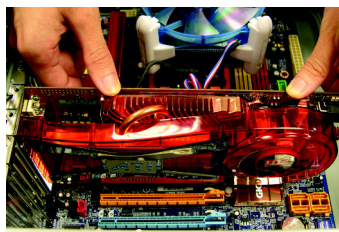

* Please make sure that the gold edge connector of the graphics card is securely inserted.

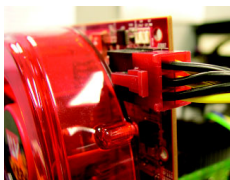

CAUTION

After installation, please connect the power cable to your graphics card, or the system will not boot.

2. Replace the screw to fasten the card in place, and replace the computer cover.

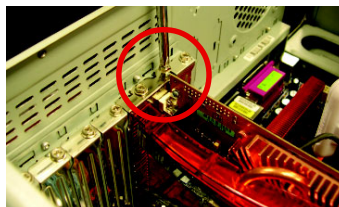

3. Plug the display cable into your graphics card; then turn on the computer and monitor. To connect a flat panel directly to your graphics card, use the DVI-I connector. To connect a VGA monitor to the DVI-I connector, plug the DVI-I to D-sub adapter into the DVI-I connector, then plug the monitor cable into the adapter.

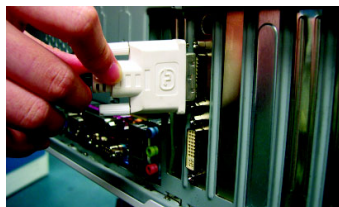

Connect a flat panel

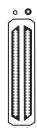

VHDCI



To Flat Panel Display



9-Pin for VIVO

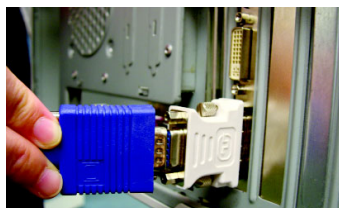

Connect a VGA monitor via DVI-I to D-sub adapter

You are now ready to proceed with the installation of the graphics card drivers. Please refer to next chapter for detailed instructions.

How to enable the ATI CrossFire™ technology (Note 1):

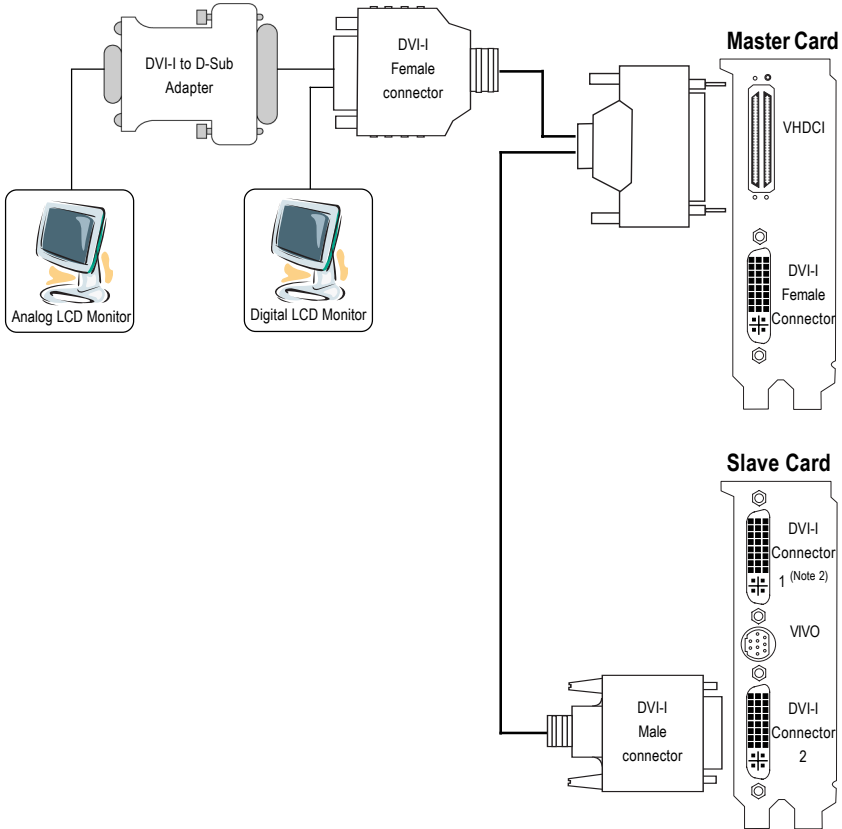

Step 1:

After installing two CrossFire graphics cards of the same chipset on a CrossFire-supported motherboard, users can enable the CrossFire technology simply through the graphics card driver.

Step 2:

After installing graphics card driver in operating system, access the ATI CATALYST Control Center (please refer to Page 19). From the ATI CATALYST Control Center, enter the CrossFire menu and assure to select the **Enable CrossFire** checkbox (please refer to Page 35) to complete the configuration.

(Note 1) Only Windows® XP operating system supports CrossFire™ mode. Please do not enable CrossFire™ in Windows® 2000.

(Note 2) The DVI-I connector of the master card and the DVI-I connector 1 of the slave card will be unavailable when the CrossFire™ technology is enabled.

3. Software Installation

In this manual, we assume that your CD-ROM Drive letter to be Drive D:

The installation of Windows® 2000 / Windows® XP drivers is very simple. When you insert the driver CD into your CD-ROM drive, you can see the AUTORUN window (if it does not show up, run "D:\setup.exe"). Then you can follow the guides to setup your graphics card driver. (Please follow the subsection 3.1.3 "Driver installation" to install the driver for your graphics accelerator.)

3.1. Windows® XP Driver and Utilities Installation

3.1.1. Operating System Requirement

- When loading the graphics card drivers for the system, please make sure your system has installed DirectX 9.0c or later version.
- If you install the graphics card drivers for the motherboard, which consist of SIS, or VIA chipsets, please install the appropriate driver program for that motherboard. Or please contact your motherboard nearest dealer for motherboard driver.

3.1.2. DirectX Installation

Install Microsoft DirectX to enable 3D hardware acceleration support for Windows® 2000 or Windows® XP to achieve better 3D performance.

- Note: For software MPEG support in Windows® 2000 or Windows® XP, you must install DirectX first. Users who run Windows XP with Service Pack 2 or above do not need to install DirectX separately.



Step 1. When autorun window show up, click the **Install DirectX 9** item.

Click the **Install DirectX 9** item.



Step 2. Choose **I accept the agreement** and click the **Next** button.

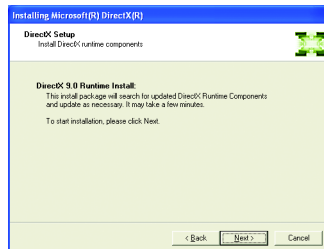

Step 3. Click the **Next** button.

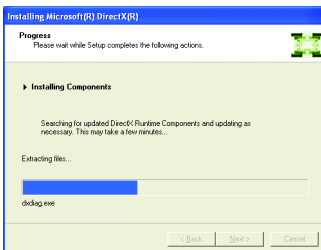

Installing the components.

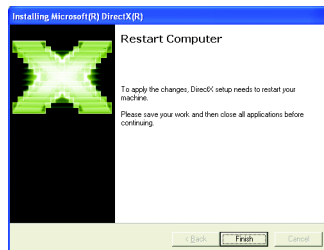

Step 4. Click **Finish** to restart computer.

Then the DirectX 9 installation is completed.

3.1.3. Driver Installation

A. New hardware found

After the graphics card is inserted into your computer at the first time, the windows will automatically detect a new hardware in the system and pop out a "New Hardware Found" message. The following is the step-by-step installation guide.

Step 1: Found new hardware wizard: Video controller (VGA Compatible)

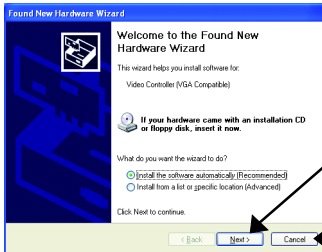

Click the **Next** button to install the driver. (There is a driver CD disk that came with your graphics accelerator, please insert it now.)

Or click the **Cancel** button to install the driver from AUTORUN window.

Step 2: Found new hardware wizard: Searching and installing

The wizard will search for the driver and install it automatically.

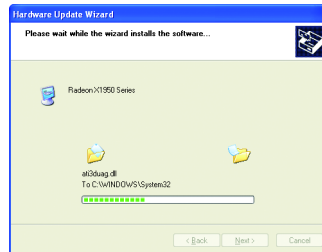
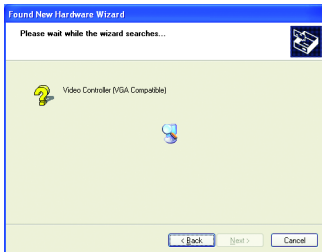

Step 3: Found new hardware wizard: Finish

Click the **Finish** button to finish the installation.



B. Driver installation (Autorun Window)

Insert the driver CD disk into your CD-ROM, and then you can see the AUTORUN window. If it does not show up, please run "D:\setup.exe".



Step 1. When autorun window show up, click the **Install Display Drivers (Radeon X1950 Series)** item.

Click the **Install Display Drivers (Radeon X1950 Series)** item.

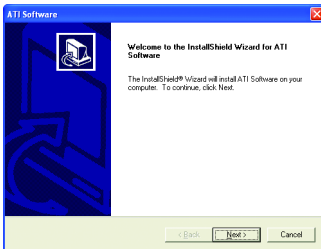

Step 2. Click **Next** button.

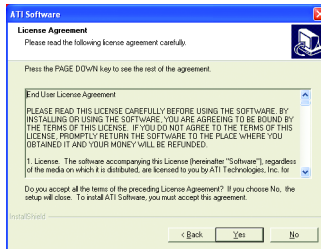

Step 3. Click **Yes** button.

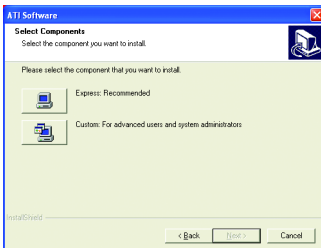

Step 4. Click **Express** or **Custom** icon.

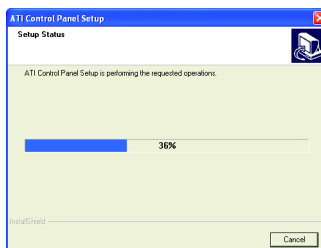

Windows installing the components.



Step 5. Click the **Finish** button to restart computer.

Then the driver installation is completed.

3.1.4. Utilities on Driver CD

● Install HydraVision :

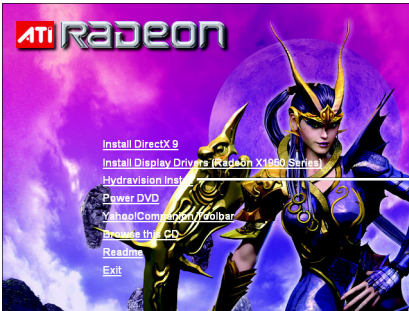

Click the **HydraVision Install** item.

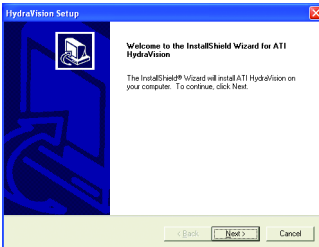

Step 2. Click the **Next** button.

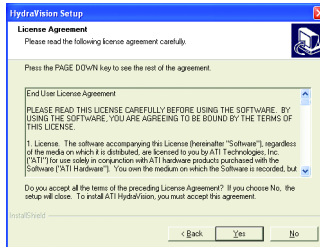

Step 3. Click the **Yes** button.

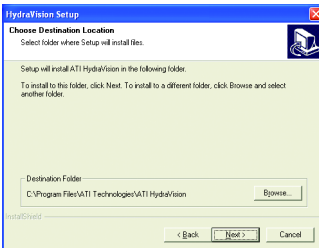

Step 4. Click the **Next** button.

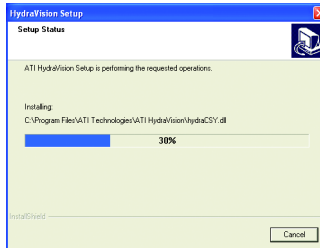

Windows installing the components.

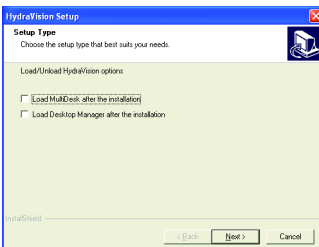

Step 5. Click the **Next** button.

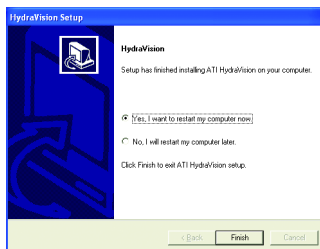

Step 6. Click the **Finish** button to restart computer.
Then the HydraVision Install is completed.

3.1.5. Video In Introduction

A. Cyberlink Power Director 3.X Installation ^(Note)

Please install the Cyberlink Power Director 3.X (or above) version with your graphics card. Press the "Capture" button, PowerDirector enter Capture mode, in which you can capture media from a variety of device. (Figure 1)

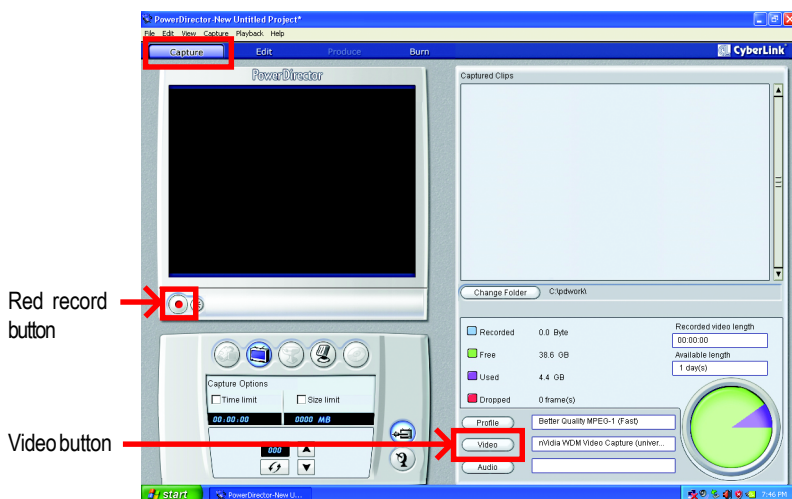

Figure 1

(Note) Power Director 3.X is supported only on the Windows® XP operating system.

B. Introduction of the capture sources device

Please check out your capture source. In general, the media sources comprise the following item:

1. Video Tape Recorder (VCR), V8 :

Connect the AV connector or video cable of the VCR to the Video In of the video capture card. And if your VCR, V8 supports S-Video output, connect S-Video connector to the S-Video In port of the graphics card.

Connect the audio cable of the VCR, V8 to the Line In of the sound card.

If your sound card has no Line In port, try the Microphone port.

2. DV (recommend to use IEEE 1394 card)

DV (Check out if the power of DV is turned on, and enter VCR mode; moreover, make sure FireWire cable connect well.

Furthermore, when capturing media by VIVO-based graphics card, you could chose two ways^(Note), including Composite (COMP-IN) and SVideo(SVID-IN). Afterward please click the play button of captured devices, and click the red REC  button between Capture preview window and Capture device selection area.



Please verify how your cable connects. If the cable connects to SVID-IN port on HDTV/VIVO cable, please press the "Video" button (Figure 2), and please select the "Video SVideo" item (Figure 2); if it connects to COMP-IN port on HDTV/VIVO cable, please select the "Video Composite" item (Figure 3).



Figure 2

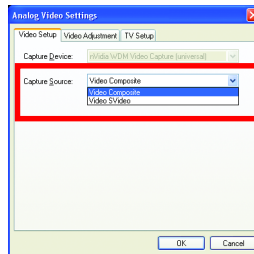

Figure 3

When you got the media you need, click the red REC button again to stop capturing. And then the media clips will be loaded into Capture clips area automatically. (Figure 4)



Figure 4

Once you click the "Edit" button to return Edit mode, the media clips will be loaded into Library immediately.

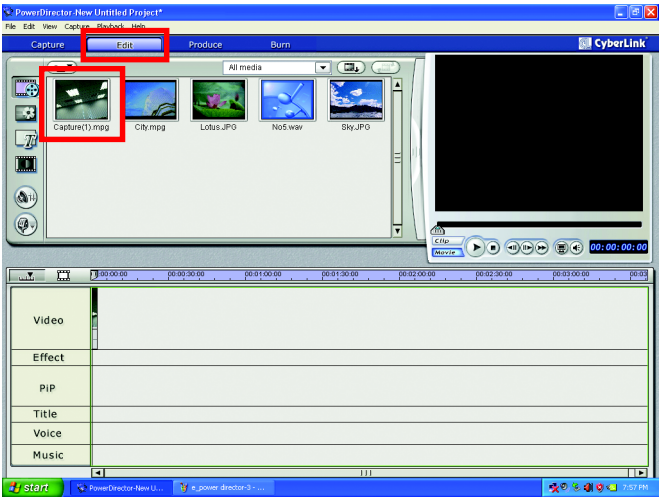

(Figure. 4)

At this moment in time, you can expand a series of outstanding editing experience to fill you life with boundless possibility.

(For more details about movie editing function of PowerDirector, please refer to user's guide, or visit Cyberlink website for official technical support.)

3.1.6. Taskbar Icon

ATI CATALYST® Control Center:

After installation of the display drivers, you will find an **ATI CATALYST® Control Center** icon  on the taskbar's status area. The **ATI CATALYST® Control Center** is used to configure all your graphics card settings. Right-click the icon to enter the **ATI CATALYST® Control Center** (refer to Fig. 1). Or you can right-click on the desktop to select Properties>Settings>Advanced>ATI CATALYST(R) Control Center tab and press **ATI CATALYST(R) Control Center** button (refer to Fig. 2).

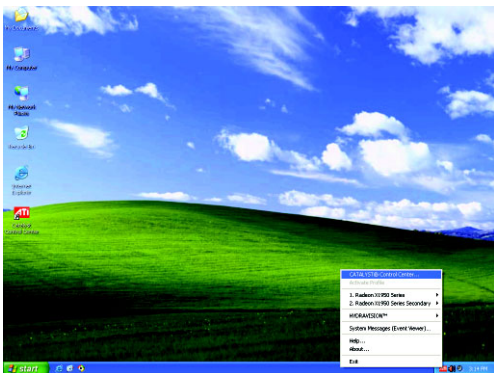

Fig. 1

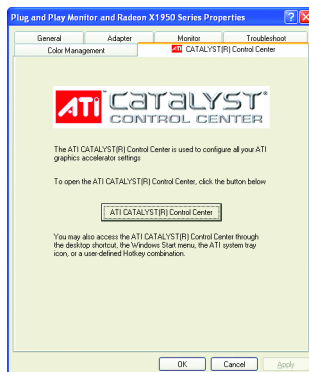



Fig. 2

HYDRAVISION™ :

HYDRAVISION has everything you need to manage increased amounts of information across your computer desktop. It allows you to quickly and easily tailor your computer desktop to the way you work. You can:

- arrange and rearrange monitors.
- create up to 9 virtual desktops.
- assign Hot Key shortcuts.
- add special effects to windows and menus.

You can right-click on **ATI CATALYST® Control Center** icon  to select **HYDRAVISION™> HYDRAVISION™ Properties** to set the HYDRAVISION (refer to Fig. 3).

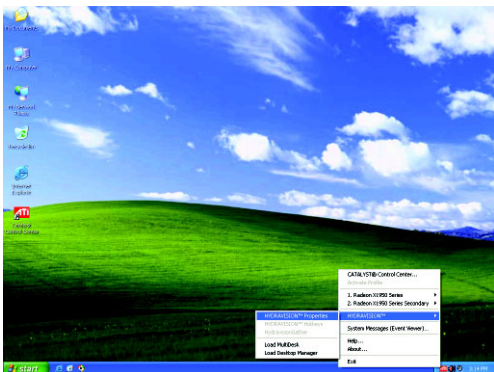

Fig. 3

3.1.7. Display Properties pages

To access Display Properties pages, right-click the GIGABYTE icon on the taskbar and select **Display Properties** or right-click on Desktop and then select **Properties**. The **Display Properties** dialog box shows the information of display adapter, color, the range of display area, and the refresh rate.

Settings (Resolutions and Color depth for Windows)

You may adjust the screen resolution and color quality settings in this dialog box.

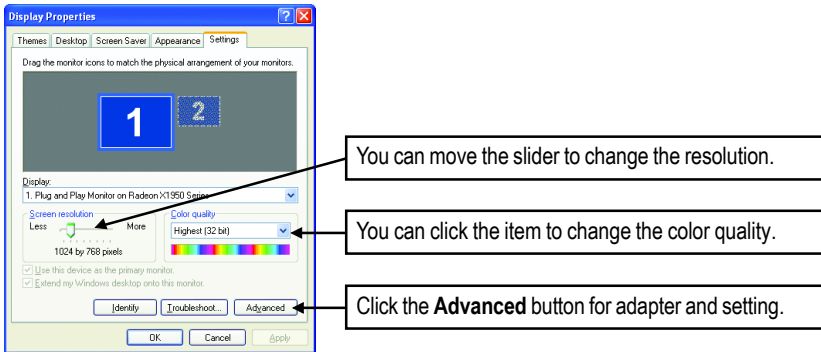

Display Matrix	Model	GV-RX195X512VB-RH
	CRT+TV (Note)	Yes
	CRT+DVI	Yes
	DVI+TV	Yes
	DVI+TV+CRT	No
	DVI+DVI	Yes

(Note) The CRT+TV configuration requires that you connect your CRT display to the DVI connector 2 on the card using the DVI-I to VGA adapter to ensure normal operation.

This configuration is not supported if the CRT monitor is directly attached to the DVI connector 1 on the card.

ATI CATALYST® Control Center Basic View :

The Basic View is the default view when CATALYST Control Center is launched for the first time. This interface provides access to the basic settings and advanced features of your ATI graphics products. You can switch between Basic View and Advanced View at any time.

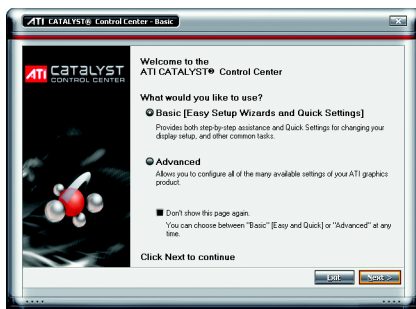

To access more settings in Basic View , click **Basic**, and then click **Next**.

Easy Setup Wizards:

Choose a wizard from the central list and click **Go** for step-by-step assistance.

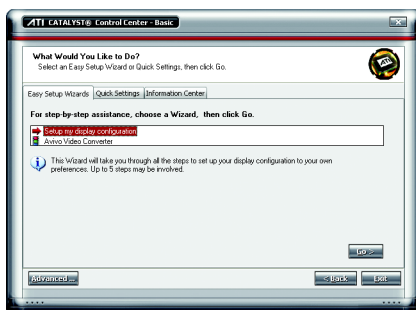

■ Setup my display configuration

This wizard allows you to configure display setting for desktop viewing.

■ Avivo Video Converter

This wizard assists you to convert videos from one file format to another.



Step 1: Select **Avivo Video Converter**, then click **Go**.

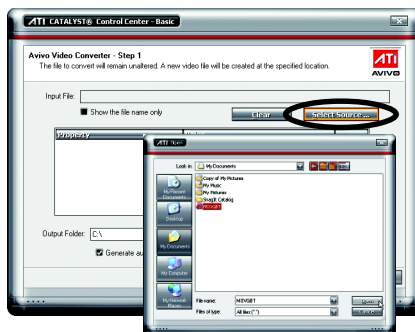

Step 2: Select the video file to be converted.

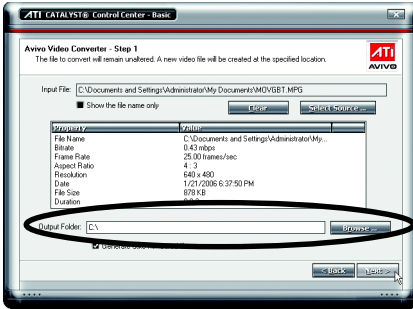

Step 3: In the **Output Folder** area, select the destination folder where the new file will be located. Click **Next**.

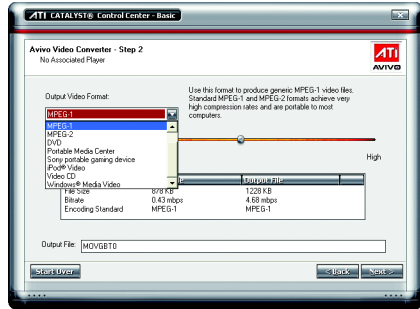

Step 4: In the **Output Video Format** list, select a file format for the new file. If you wish to change the name of the new file, enter the new name in the **Output File** area. Finally, click **Next** to start file conversion.

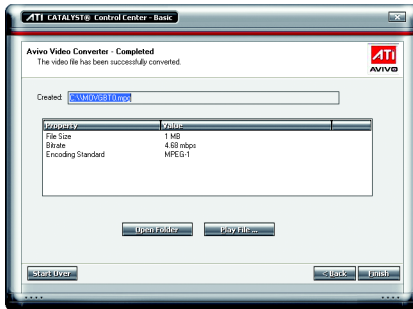

The video file has been successfully converted.

Quick Settings:

The Quick Settings page provide access to three main settings.

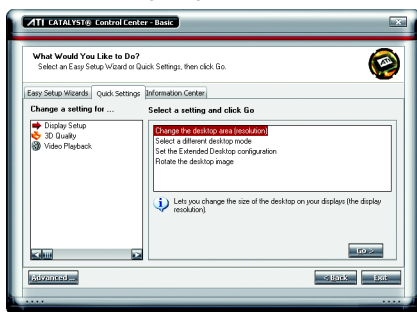

- **Display Setup**
This option allows you to configure your desktop, including changing desktop resolution and desktop mode, setting up extended desktop (requires more than one display), and rotating desktop image to match new display orientation.
- **3D Quality**
3D Performance and Quality settings allows your 3D games and applications to get faster performance and better quality with a more balanced setting.
- **Video Playback**
Use this option to optimize video playback in different room environment or to select how video playback appears on the second display.

Information Center:

The Information Center page in Basic and Advanced View provides hardware and software information about the installed graphics card.

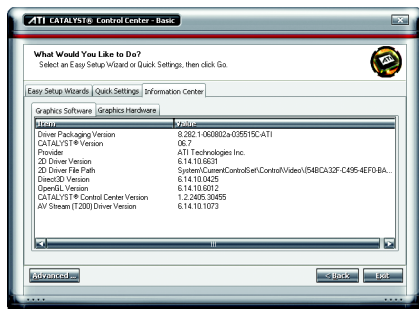

- **Graphics Software**
Provides software information including driver version, CATALYST version, Direct 3D version and so on.
- **Graphics Hardware**
Provides hardware information including graphics chipset, BIOS version, memory size, core clock and so on.

ATI CATALYST® Control Center Advanced View

The Advanced page allows you to configure all of the many available settings of your ATI graphics card.

View Properties:

The CATALYST Control Center dashboard supports three types of views:
Basic View/ Advanced View/ Custom View.



■ Basic View

The Basic view is the default view when CATALYST Control Center is launched for the first time. Refer to the previous pages for details.

■ Advanced View

The Advanced view provides access to the advanced features on each page. The left navigation pane displays a tree view that lists all the advanced features. The Advanced view is recommended for experienced users.

■ Custom View

The Custom view allows you to display only the features you choose in the left navigation pane. The Custom view is recommended for experienced users who want to expose only the features they adjust most often or that their 3D application supports.

Hotkeys Properties:

The Hotkeys Manager allows you to create shortcut key combinations to quickly perform tasks such as changing a graphics setting or opening an application. A Hotkey is a combination of a modifier key or keys, such as Ctrl, Alt, or Shift, and any letter from the alphabet.

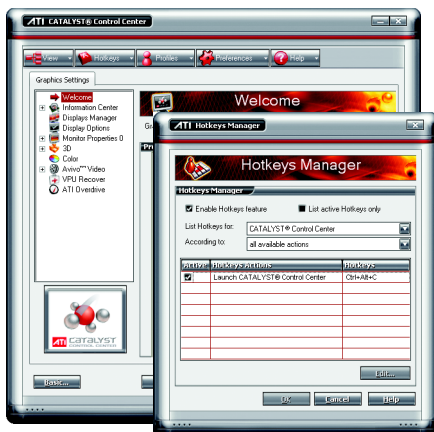

Profiles Properties:

You can use profiles to create customized environments for your desktop, video, and 3D applications. Define and save your own personal video settings that can be quickly activated manually, through a Hotkey, or by file association.

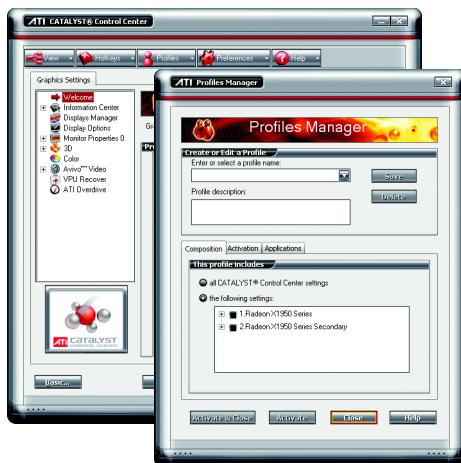

Note:

A profile applies to a specific graphics card. If there is more than one graphics card installed in your computer, you need to select the appropriate card before creating, loading, or activating a Profile.

Preferences Properties:

The Preferences page helps to restore defaults, change skins, and update the CATALYST Control Center. The CATALYST Control Center Preferences page contains the following options:



- Always on Top
- Hide Tooltips
- Hide Toolbar Text
- Hide Splash Screen
- Enable System Tray menu
- Select a Language ...
- Select a Skin ...
- Restore Factory Defaults ...

Help Properties:

The CATALYST Control Center Help feature allows you to access the comprehensive online help, register your product, or generate a problem report should you require technical support.

The CATALYST Control Center Help feature offers the following options:



- Help for this Page ...
- Help Contents ...
- Search Help ...
- Go to ATI.com
- About CATALYST® Control Center ...

Displays Manager :



Use Displays Manager to set your desktop resolution, the display refresh rate, and arrange your displays.

Display Options :



The Display Options aspect gives you additional control to optimize performance of OpenGL® and Direct 3D® applications.

Use **3D Refresh Rate Override** to set a refresh rate of your choice when a full-screen application or game has a default refresh rate that is lower than optimal.

Choose one of the **Display Detection Options** to prevent screen flicker when detecting a display. If you are using an older TV or one that has non-standard inputs that may not be automatically detected, use **Force TV Detection**.

Monitor Properties 0 :



■ Attributes

Attributes provides information about the attached monitor. You can also enable Extended Display Identification Data.

Extended Display Identification Data (EDID) uses the information provided by the attached monitor to determine the limits for the resolution and refresh rate.

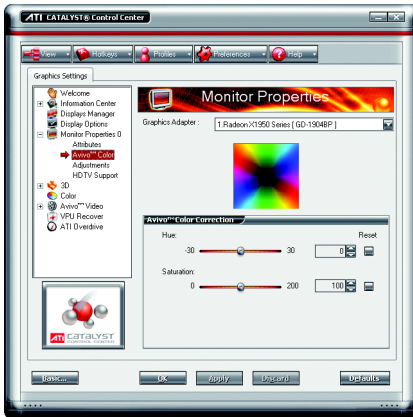

■ Avivo™ Color

Use Avivo™ Color for ATI graphics cards that supports per-display color settings.

Independently set the hue, saturation, and temperature for each attached and enabled display.



■ Adjustments

Use Adjustments to resize and reposition the computer desktop on your monitor's display screen. You can also adjust the horizontal and vertical sync or enable composite sync.



■ HDTV Support

Use HDTV Support when your CRT or DFP display device supports one or more HDTV modes that are not initially listed in the Displays Manager due to an incomplete EDID (Extended Display Identification Data). Selecting one or both of the HDTV modes adds them to the Force button located in the Displays Manager when the associated display is selected. If you have both CRT and DFP display devices and want both to support HDTV, you select both the Add 720p and Add 1080i check boxes in the corresponding HDTV Support pages.

Note: Forcing a display mode that exceeds its EDID limits may result in permanent damage to your display!

3D :



■ Standard Settings

The Standard settings page provides access to a universal slider control where you can simultaneously adjust all of the standard 3D settings for any type of 3D application. The slider enables you to adjust for overall system performance, overall 3D image quality, or a balance between the two.

This page is useful when you are not aware of which type of 3D settings your application uses, or when you want to use an overall adjustment control that rapidly configures your application.



■ Anti-Aliasing

Anti-Aliasing is a technique used to smooth out the jagged edges of three-dimensional curved objects or objects with diagonal edges.

Anti-aliasing can be set to favor either an increase in system processing performance or improved image quality:

Setting for performance is best used when the 3D image is animated and smoothness of motion is the most important consideration.

Setting for quality is best used when having highly detailed and realistic 3D objects is the primary concern.

If you are unsure of how to configure anti-aliasing, use the Let the Application Decide option. Your display will automatically adjust to the application's requirements.



■ Adaptive Anti-Aliasing

Adaptive anti-aliasing is a technique that applies a combination of multi-sampling (MSAA) and super-sampling (SSAA) on 3D objects to improve edge smoothness and fine detail. This feature renders 3D objects containing transparencies more realistic, providing exceptional levels of image quality while maintaining performance.



■ Anisotropic Filtering

Anisotropic filtering is a technique that preserves detail on surfaces that have three-dimensional perspective and fade away into the background. It works best when used in conjunction with Mipmapping.

Anisotropic filtering can be set to favor either an increase in system processing performance or improved image quality:

Setting for performance is best used with applications that display objects with smooth, simple surfaces, like those seen in CAD applications.

Setting for quality is best used with applications that display highly detailed scenes, backgrounds, and textured objects, like those seen in 3D games. If you are unsure how to configure anisotropic filtering, use the Let the Application Decide option. Your display will automatically adjust to the application's requirements.



■ CATALYST® A.I.

Catalyst® A.I. makes use of ATI's new texture analyzer technology to optimize performance in 3D applications while maintaining or even improving image quality. It analyzes individual textures as they are loaded to determine the best and fastest way to display them.



■ Mipmap Detail Level

Mipmapping is a texturing technique that preserves the detail on a 3D object's surface as it moves into the background. A series of low- and high-resolution texture maps are stored in memory and selectively used to create the object's surface, depending on what level of detail is needed.

Mipmap detail level can be set to favor either an increase in system processing performance or improved image quality:

Setting for performance is best used when the 3D image is animated and smoothness of motion is the most important consideration.

Setting for quality is best used when high surface detail is required, especially if the animated object rotates or moves into the background.



■ All Settings

The All Settings page combines all of the principal 3D features onto a single page, without any preview window, allowing for quick access and adjustment. You can change the settings for the following 3D features as you normally would on each feature's own page:

- Anti-aliasing
- Anisotropic filtering
- CATALYST® A.I.
- Mipmap detail level
- Wait for display refresh
- Adaptive Anti-Aliasing

This page is useful when it is not necessary to preview the adjusted settings because the effect is already known or understood.



■ API Specific

The 3D API-Specific dialog helps to select settings that are exclusively for the Direct3D® and OpenGL® Application Programmable Interfaces (API). These settings are provided for resolving certain incompatibilities within 3D applications that use one of these APIs.

Use this dialog when you are know which type of API (Direct3D® or OpenGL®) your 3D application uses, and you want to select a particular API-specific feature.

If you are not sure which API your 3D application uses, consult the documentation of your 3D application.

Color :

Adjust the overall richness of color by using the Gamma control. To adjust the overall brightness use the Brightness control, and the overall contrast use the Contrast control.

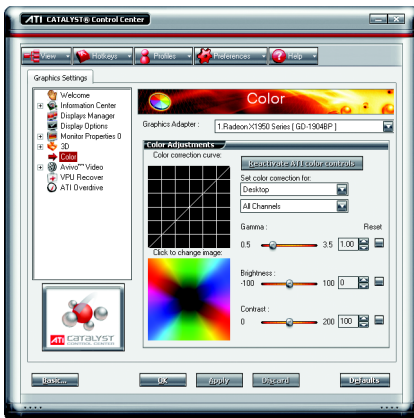

Avivo™ Video :



Use the Avivo™ Video aspect to apply standard video settings with a Wizard or selecting a video preset. Use Adjustments to configure gamma, brightness, and hue. Use Theater Mode to set aspect ratio and overlay display mode. Preview your changes before applying them.

■ Standard Settings

To quickly adjust your video settings choose one of the video presets or use the Video Wizard to configure your display devices.



■ Adjustments

Use Video Adjustments to manually set Gamma, Brightness, Contrast, Saturation, and Hue for video playback.

Note: Certain video formats do not support these adjustments.



■ Theater Mode

Use Theater Mode to change the way you view streaming video.



■ Deinterlacing

Deinterlacing creates a sharp image from the two video fields of interlaced video. Select one of six options for deinterlacing video for better viewing.

Auto Detect lets the multimedia driver to select the best deinterlacing scheme for different video sources and sizes.

Bob deinterlacing, when selected, removes every other line of the video image and is recommended for motion video.

Adaptive deinterlacing, when selected, reacts to the amount of motion in the video and apply a media filter on a motion block and apply weave on the remaining blocks.

Motion Adaptive deinterlacing, when selected, applies the advanced motion detection to deinterlace the video.

Vector Adaptive deinterlacing, when selected, produces smoother, less jagged edges for interlaced video playback.

Weave does not apply any deinterlacing.

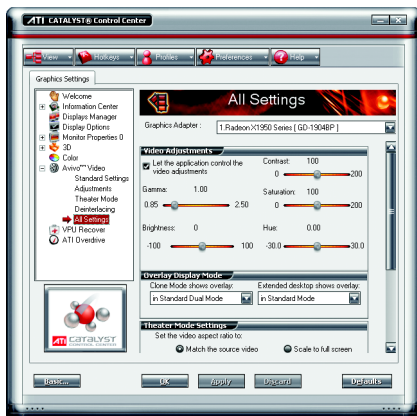

■ All Settings

The All Settings page combines all of the principal Video features onto a single page, without any preview window, allowing quick access and adjustment.

This page is useful when it is not necessary to preview the adjusted settings because the effect is already known or understood.

VPU Recover :

VPU Recover enables the ATI display driver to detect when the graphics processor stops responding to display-driver instructions. When this happens, the display driver attempts to reset the graphics hardware. In most cases, VPU Recover will be able to reset the graphics processor without requiring a system restart.

Should the computer be unable to recover from a crash, VPU Recover will switch the computer to software rendering mode, allowing you to save any work in progress before restarting the computer.



- Enable VPU Recover
- Prepare an error report if VPU Recover is activated, for submission to ATI Technologies. Allows the VPU Recover, once it is activated, to generate an error report that you can send to ATI via e-mail.

ATI Overdrive :

Use the ATI Overdrive aspect to maximize the performance of the graphics processing unit (GPU) on your graphics card. An on-chip thermal sensor constantly monitors the temperature of the GPU allowing the maximum clock speed to be maintained while avoiding overheating. If the GPU gets too hot, the ATI Overdrive aspect will automatically decrease the clock speed until a safe temperature is reached. The ATI Overdrive aspect will never reduce the graphics processor speed below the default clock speed.





CrossFire™ :

CrossFire^(Note) delivers exceptional performance on a single display by combining the processing power of two or more Graphics Processing Units (GPUs).

(Note)

Only Windows® XP operating system supports CrossFire mode. Please do not enable CrossFire in Windows® 2000.

3.2. Windows® 2000 Driver Installation

With Windows running on your computer, you need to install the graphics card driver to take advantage of the higher performance, resolutions, and special graphics features of the graphics card. To ensure you install the latest driver, insert the Installation CD that shipped with your graphics card.

To install the graphics card driver for Windows® 2000, please insert the Installation CD. Then the AUTORUN window will show up. Click **Install Display Driver** item, and follow the wizard to install the driver.

If Windows® does not show the CD automatically, please run following steps:

1. Click the **Start** button on the control bar.
2. Select **Run**.
3. Type the following: D:\SETUP.exe
(If D is not your CD-ROM drive, substitute D with the correct drive letter.)
4. Click **OK**.
5. Click on **Install Display Drivers** to begin the Installation Wizard.
6. Click **Next**.
7. Click **Yes** to the license agreement.
8. Follow the Wizard's on-screen instructions to complete the installation.



Please make sure the Windows® 2000 have installed Windows® 2000 Service Pack (or later) before installing the graphics accelerator driver.

4. Troubleshooting Tips

The following troubleshooting tips may help if you experience problems. Contact your dealer or Gigabyte for more advanced troubleshooting information.

- Check that the card is seated properly in the PCI Express x16 slot.
- Ensure that the display cable is securely fastened to the card's display connector.
- Make sure that the monitor and computer are plugged in and receiving power.
- If necessary, disable any built-in graphics capabilities on your motherboard. For more information, consult your computer's manual or manufacturer.

(NOTE: Some manufacturers do not allow the built-in graphics to be disabled or to become the secondary display.)

- Make sure you selected the appropriate display device and graphics card when you installed the graphics driver.
- Restart your computer. Press the **F8** key on your keyboard after system starts up. When the Windows Advanced Options Menu appears, select Safe Mode and press Enter. After getting into Safe Mode, in Device Manager check whether the driver for the graphics card is correct.
- For more assistance, use the Troubleshooting Guide located in the Windows® Help or contact your computer manufacturer.



If necessary, adjust your monitor's setting by monitor's adjust panel to make the screen looks focused, crisp, and sharp. (Please refer to the monitor's manual.)

5. Appendix

Resolutions and Color Depth Table (In Windows® XP)

Radeon X1950 XTX 2D Single Display Modes

Display Screen Resolution	Maximum Refresh Rate (Hz)	Color Depth (bpp)		
		8bpp(256 color) Standard mode	16bpp(65K color) High mode	32bpp(16.7M) True mode
640 x 480	200	✓	✓	✓
800 x 600	200	✓	✓	✓
1024 x 768	200	✓	✓	✓
1152 x 864	100	✓	✓	✓
1280 x 768	85	✓	✓	✓
1280 x 960	160	✓	✓	✓
1280 x 1024	120	✓	✓	✓
1600 x 1200	100	✓	✓	✓
1792 x 1344	85	✓	✓	✓
1800 x 1440	70	✓	✓	✓
1856 x 1392	75	✓	✓	✓
1920 x 1080	75	✓	✓	✓
1920 x 1200	85	✓	✓	✓
1920 x 1440	75	✓	✓	✓
2048 x 1536	66	✓	✓	✓

Radeon X1950 XTX HDTV Display Modes

	Display Screen Resolution	Maximum Refresh Rate (Hz)
480i	640 x 480	30
	704 x 480	30
	720 x 480	30
480p	640 x 480	60
	704 x 480	60
	720 x 480	60
	856 x 480	60
720p	960 x 720	60
	1280 x 720	60
1080i	1920 x 1080	30

* The table is for reference only. The actual resolutions supported depend on the monitor you use.

