

Aivia



URANIUM

WIRELESS GAMING MOUSE
WITH GHOST MACRO STATION

— USERS' GUIDE —

CONTENTS

Introduction	02
Package Content & Support	02
Installation	03
Mouse Instructions	06
GHOST Macro Station	08
GHOST Macro Engine	11
Battery & Charging	22
Safety	23
Maintenance	24

■ Introduction

The Aivia Uranium wireless gaming mouse equipped with revolutionary GHOST Macro Station which allows dynamic mouse status update and prompt assignment for mouse buttons. Introducing GIGABYTE's patent pending technology, built-in memory into the receiver ensures your gaming commands are executed directly from the receiver and free from any risk of signal loss or delay.

With 6500dpi, 1000Hz polling rate, and amazing 50hrs continuous gaming capability, Aivia Uranium performs as well cordless as it does corded, giving you an unparalleled freedom of frenzy motion on the battlefield.

■ Support

Register your Aivia Uranium on the Aivia Forum www.aivia.gigabyte.com for free online technical support.

■ Package Contents

- Aivia Uranium Wireless Gaming Mouse
- GHOST Macro Station (OLED receiver)
- 2*AA NiMH 2100mAh Rechargeable Battery
- Spare Teflon Mouse Feet Pads
- Cleaning Cloth
- Users' Guide

■ Installation

1 Connect the GHOST Macro Station

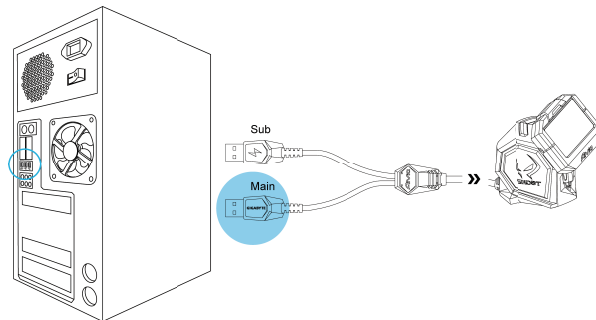

OS support: Windows® 98/ 2000/ XP/ 7/ 8

2 Insert AA Rechargeable Batteries

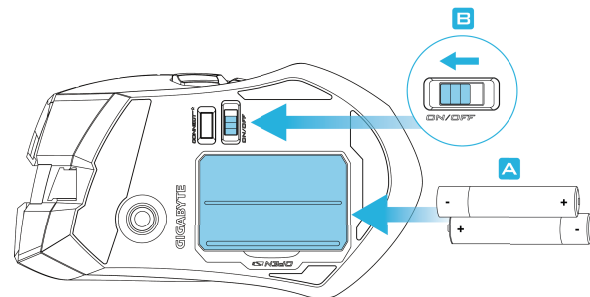

We've included 2 rechargeable NiMH batteries, but it will also run on normal AA alkaline batteries.

3 Install Aivia GHOST Engine



Download the Aivia GHOST software from GIGABYTE's official website for further macro recording.

4 Instant Power Charging

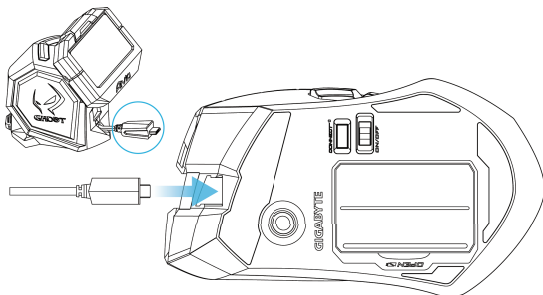

Pull out the charging cable for instant power supply. You can use the mouse while charging.

5 Synchronize Mouse and Receiver

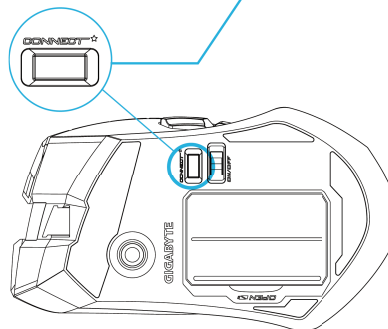
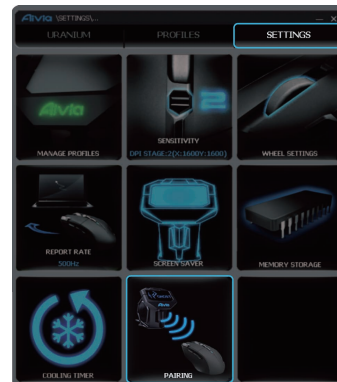

The re-pairing process is needed only when the mouse loses connection with the receiver.

■ Mouse Instructions

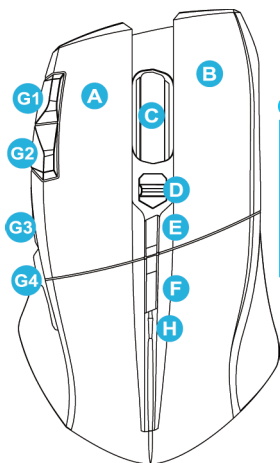

H Power & Wheel Indicator

Switch On	Blue LED lit up for 5sec
Low Power	Blinking red light
Live-editing Mode	Blue LED continuously lit up till unlocked (refer to page08 GHOST Macro Station)

- A – Left Click
- B – Right Click
- C – Scroll Click and 4-direction Wheel
- D – On-the-fly DPI Adjustment
- E – Wheel Controller Lock
- F – Profile Switch
- G1 – Gaming Button (unassigned)
- G2 – Gaming Button (unassigned)
- G3 – Gaming Button (forward)
- G4 – Gaming Button (backward)
- H – Power & Wheel Indicator

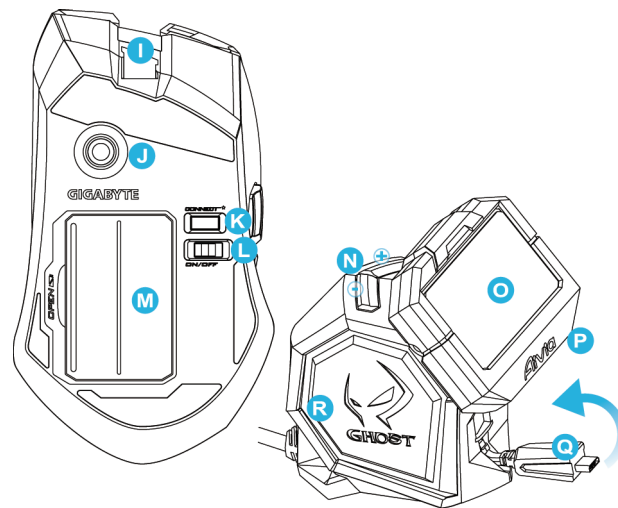

- I – Micro USB Connector Jack
- J – Twin-eye Laser Sensor
- K – Pairing Button (Connect)
- L – Power ON/OFF
- M – AA Battery Slot
- N – Screen Brightness Adjustment
- O – OLED Display
- P – 5-color Profile Indicator
- Q – Retractable Micro USB Charging Cable
- R – Built-in GHOST Macro Engine

■ GHOST Macro Station

GHOST macro station is your control center built for your gaming task, features dynamic status display, hot-switchable macro system and instant charging dock.

Dynamic Display Mode

Dynamic update and display DPI value, report rate, gaming profiles, and remaining battery life of your Alvia Uranium.

Live Editing Mode

Prompt re-assign macro hotkeys and set-up DPI value directly through GHOST station.

Switch on the "wheel controller lock" to use the mouse wheel like a D-pad controller for OLED on-screen settings.

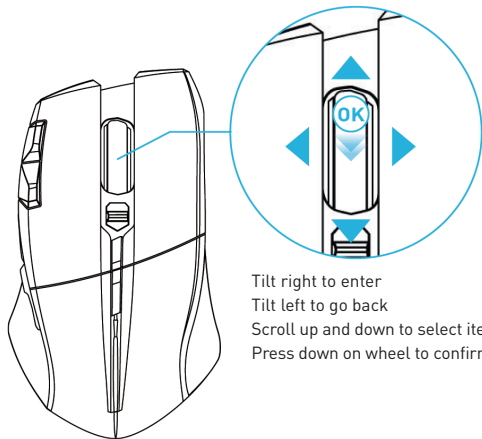

Tilt right to enter
Tilt left to go back
Scroll up and down to select items
Press down on wheel to confirm changes

Profile

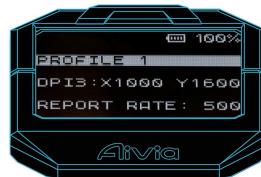

1

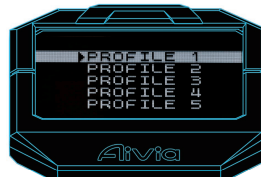

Select one of the profiles you wish to program

2



Select a mouse button you wish to program

3



Select the function category: Basic/Key Mapping/Macro (refer to page 13)

4

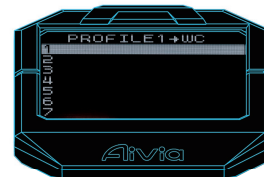

Choose the function and press scroll click to confirm setting

DPI Value

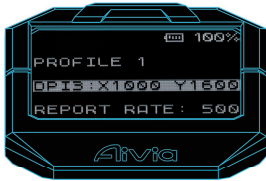

1



Select the DPI stage you wish to define

2



Scroll backward and forward the wheel to adjust DPI value for both X and Y axle.

Press scroll click to save the change

Report Rate



1



Scroll backward and forward the wheel to adjust how fast the reports (125/142/166/200/250/333/500/1000Hz selectable)

Press scroll click to save the change

■ GHOST Macro Engine

GHOST Macro Engine supports Windows 98, Windows 2000, Windows XP, Windows 7, and Windows 8.

► MAIN PAGE



The main page is the home page when you first install GHOST Macro Engine. More than one model may appear when you install other Aivia products.

1. Choose the Aivia model you wish to set up.
2. Click "PROFILES" to set up button assignments for the particular model.
3. Click "SETTINGS" to set up performance, lighting, and manage profiles.

You may also link to  or  for more product information.

▶ PROFILES



In the PROFILES tab, there are 5 profiles which appear as 5 LED bars

PROFILES underneath PROFILE to program for your specific games. A single LED bar indicates the current profile you are accessing. For each profile, you can assign either BASIC functions or advanced MACROS to particular buttons. Click on any mouse button you wish to set up, you will then enter into the function menu.

(There are also hidden buttons by clicking the downward arrowhead - **DEFAULT** is to reset all settings for the current profile back to default; **DEFAULT ALL** is to reset all 5 profiles back to factory default.)

(BASIC)

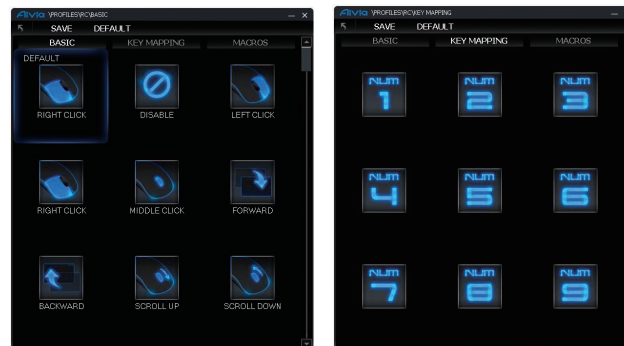

1. Select any button function you wish to change, and click **SAVE** or double-click to save the changes
2. or click **ESC** to ignore the change and go back to previous page
3. or click **DEFAULT** to return the default setting.

(KEY MAPPING)

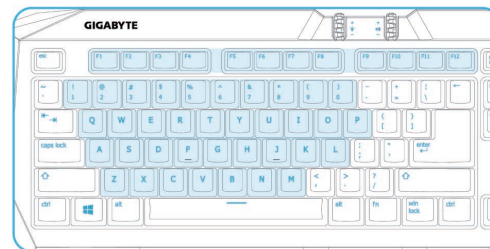

You may simply map a mouse button to a specific key on the keyboard, includes A-Z, num1-0, F1-F12

(MACROS)



Macro depot is where you can pre-record a series of keystrokes and button presses with precise time interval for gaming commands. Here you have 70 blank macro cartridges. Pre-define the macro scripts and then assign to any mouse buttons.

Select any empty macro and click **EDIT**, and you will then enter into the macro depot.

★ How to record a macro script?

1. Understanding your Tool Box

Enable / Disable Pause Key to stop recording



Chose your recording objects

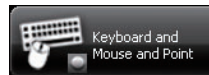

Record keystrokes, mouse button press and also cursor's coordinates.



Record both keystrokes and mouse button press.

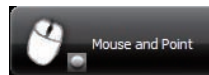

Record mouse button press and also cursor's coordinates.

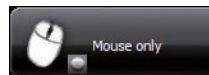

Only record mouse button press but ignore keystrokes.

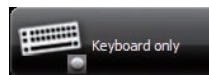

Only record keystrokes but ignore mouse button press.

Time delay (interval)

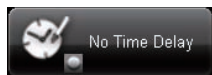

Do NOT record any time delay in-between commands.

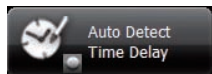

Record the real delay in-between as how it is entered.

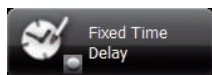

Key-in the time interval as a fixed time delay.

Action mode



Execute a macro once as press the mouse button once.

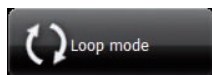

Execute a macro continuously, and press again to stop the running macro.

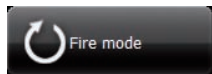

Execute a macro continuously until you release the assigned button.



2. Now begin to record a macro

Step1 Modify your tool box buttons to set up your recording preference.

Step2 Click  and start keying in keystrokes or button presses.



Step3 Click  to end recording

Step4 You may also insert additional commands from the "Quick-insert bar" the left menu.

Step5 Type on (the blue box)  to rename this macro. Moreover, you may also change icon of your personal macro by clicking on 

Step6 Click  to save the editing of this macro.

3. More:

You may  the macros you'd edited to the PC, and also  a macro back to GHOST macro engine.

▶ SETTINGS



MANAGE PROFILES

You may either disable or enable a whole profile and also change the color of the profile indicator in this page.



SENSITIVITY

Sensitivity is how fast the mouse cursor travels across the screen. You can create 4 preferred sensitivity stages by moving the single adjusting slider, and click  to set different sensitivity value of X-Y axis independently.

Default: 800 / 1600 / 3200 / 5600 DPI.



WHEEL SETTINGS

You can adjust the scrolling and tilt speed by moving the knob on the slider.



REPORT RATE

The report rate determines the time intervals that your PC retrieves data from your mouse. You can switch between to 125Hz, 142Hz, 166Hz, 200Hz, 250Hz, 333Hz, 500Hz, or 1000Hz on the slider.

Default setting: 500Hz



SCREEN SAVER

The OLED screen will show screen saver logo when the mouse stop working for 10mins. Except the default logo, you can customize the other display logo as a screen saver for your GHOST Macro Station.

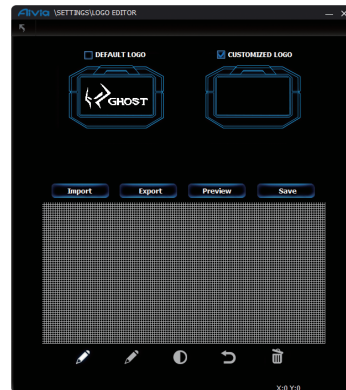

You may directly import a photo (bmp format only) from PC or manually draw on the bitmap.



COOLING TIMER

The cooling timer allows you to release a specific command again in the game which would limit the command execution interval. There are three timers for pre-setup.



- 1 Select a mouse button which you would use for a gaming command
- 2 Input the cooling time interval
- 3 Type on the reminder script for this timer to remind yourself
- 4 Select the show-up effect: Highlight/ Blinking
- 5 Click Enable/ Disable to activate the timer

Note!

The cooling timer is effective only when running Aivia GHOST. Exiting the Aivia GHOST software will automatically close the timer function.



MEMORY STORAGE

- Clean Memory** Erase all data on memory, such as settings and macros
- Backup** Back up the profile settings or macros to your PC
- Restore** Restore the backed up the settings or data from your PC

Note!

Please DO NOT remove the mouse during processing in case memory damages.



PAIRING

When the mouse loses connection with the receiver for some reason, you can re-connect them by this setting. Click Pairing and then press the rubber button on the bottom of mouse.

Note!

You may need another mouse to control the cursor during pairing process. The mouse will be reinstated once the pairing process is complete.

■ **Battery and Charging**

- For best condition, please fully charge the battery the first time you use Aivia Uranium. It takes about 4 hours to fully charge 2*AA NiMH 2100mAh rechargeable batteries as you plug the single main USB connector. You may speed up the charging time by plugging both the USB connectors of the charging dock.
- The remaining battery life info shown on the OLED screen may temporarily fluctuate when powering on or suddenly terminating charging process. It will recalibrate after few minutes to provide the proper battery life.
- If the battery was running too low and shutting down the mouse eventually, please immediately charge the battery and restart the mouse.
- The battery charging process may be affected by using non-powered USB port from certain USB hub, keyboard, or other devices.
- Remove the batteries if they are worn out or before storing your mouse for an extended period of time.
- Charge only with the recharger provided with the product.
- Operation times and performance of battery may vary depending on operator network configuration, signal strength and usage.

■ **Important information**

Long period of repetitive motion using an improperly set-up workplace, or incorrect body posture may be associated with physical discomfort and injury to nerves, tendons, and muscles.

■ **Safety**

Caution:

- Please DO NOT directly look into the laser beam.
- Keep batteries away out of children.
- Dispose or recycle the worn-out batteries in accordance of Local and National Disposal Regulations.
- Risk of explosion if battery is replaced by an incorrect type. Use and replace only with the same type and rating as the batteries provided.
- Risk of explosion if charging with the non-rechargeable batteries.
- In order to avoid the electric shock generated by energy hazard, the input power of this product should be SELV.

FCC Declaration:

• This device has been tested and found to comply with the limits for a Class B digital device, pursuant to Part 15 of the FCC Rules. These limits are designed to provide reasonable protection against harmful interference in a residential installation. This equipment generates, uses and can radiated radio frequency energy and, if not installed and used in accordance with the instructions, may cause harmful interference to radio communications. However, there is no guarantee that interference will not occur in a particular installation. If this equipment does cause harmful interference to radio or television reception, which can be determined by turning the equipment off and on, the user is encouraged to try to correct the interference by one or more of the following measures:

- Reorient or relocate the receiving antenna.
- Increase the separation between the equipment and receiver.
- Connect the equipment into an outlet on a circuit different from that to which the receiver is connected.
- Consult the dealer or an experienced radio / TV technician for help.

• This device complies with part 15 of the FCC Rules. Operation is subject to the following two conditions: [1] This device may not cause harmful interference, and [2] this device must accept any interference received, including interference that may cause undesired operation.

FCC Caution:

- Changes or modifications not expressly approved by the party responsible for compliance could void the user's authority to operate the equipment.
- The antenna(s) used for this transmitter must not be co-located or operating in conjunction with any other antenna or transmitter.

■ Maintenance

1. Should you have trouble operating the mouse properly, please contact GIGABYTE customer service center on www.gigabyte.com for support. Do not attempt to service or fix the device yourself at any time.
2. Do not take the mouse apart (doing so will also void your warranty).
3. Keep your mouse away from liquid, humidity or moisture. Operate your mouse only within the specified temperature range of 0°C (32°F) to 40°C (104°F). Should you operate it in a temperature that is beyond this range, unplug and switch off the device in order to let the temperature stabilize within the optimal temperature range.

■ Production Information

Aivia Uranium Wireless Gaming Mouse
Model No.: GM-Uranium