

GIGABYTE™

# U2440

USER'S MANUAL

使 用 手 冊

● English

V3.0

## Congratulations on your purchase of the GIGABYTE Notebook.

This manual will help you to get started with setting up your notebook. The final product configuration depends on the model at the point of your purchase. GIGABYTE reserves the right to amend without prior notice. For more detailed information, please visit our website at [www.gigabyte.com](http://www.gigabyte.com)

# 1 Using GIGABYTE Notebook for the First Time

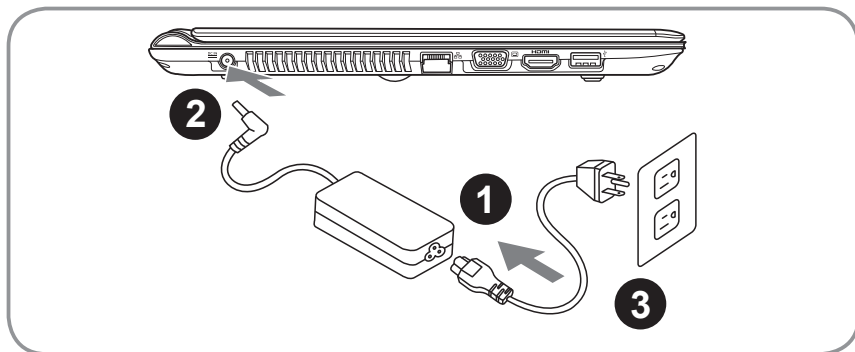

- 1 Connect the power cord to the AC adapter.
- 2 Connect the AC adapter to the DC-in jack on the right side of the notebook.
- 3 Connect the power cord to the power outlet.

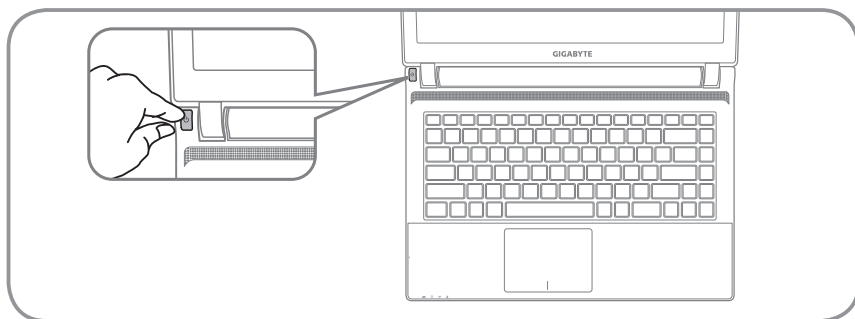

## Switching on the Power

After you turn on the U2440 for the very first time, do not turn it off until the operating system has been configured. Please note that the volume for the audio will not function until Windows® Setup has completed.





## Booting Up the U2440 for the First Time

Depending on your configuration, the Microsoft® Windows® Boot Screen will be the first screen that you will see as the notebook starts up. Follow the on-screen prompts and instructions and enter your personal information to complete the setup of the Windows® Operating System.

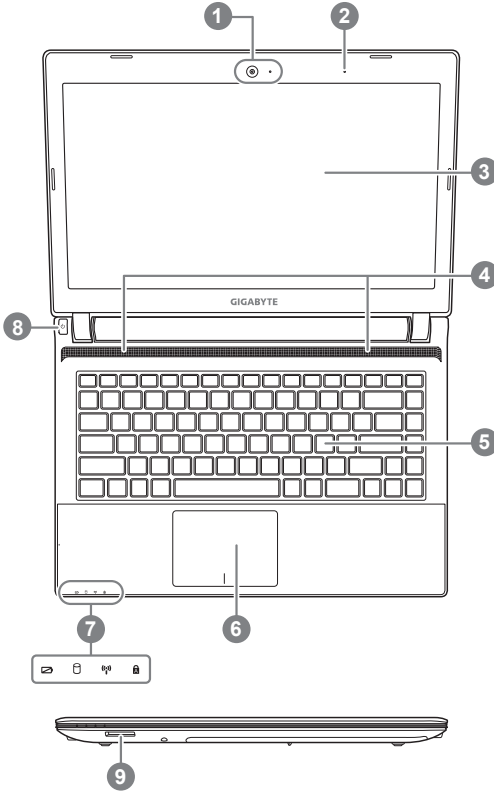
# 2 Your GIGABYTE Notebook Tour

## Top View



- 1 Webcam ①
  - 2 Microphone
  - 3 Display panel
  - 4 Audio Speakers
  - 5 Keyboard
  - 6 Touchpad and buttons
  - 7 Status indicators ②
  - 8 Power Switch
  - 9 Flash Memory Card Reader
- ① Webcam on or off indicator
  - ②  Battery charge Indicator
  -  Drive Activity Indicator
  -  Wireless Indicator
  -  Capital Lock Indicator

## Left View

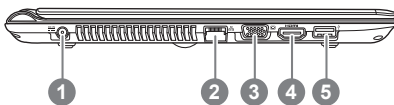

- 1 power DC input
- 2 LAN Port
- 3 Display (Monitor) output
- 4 HDMI Port
- 5 USB 3.0 Port

## Right View

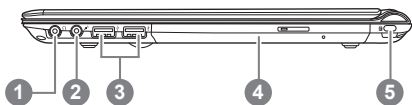

- 1 Headphone output Jack
- 2 Microphone input Jack
- 3 USB Ports(2.0)X 2
- 4 Optical Drive
- 5 Kensington Lock Port

## Base View

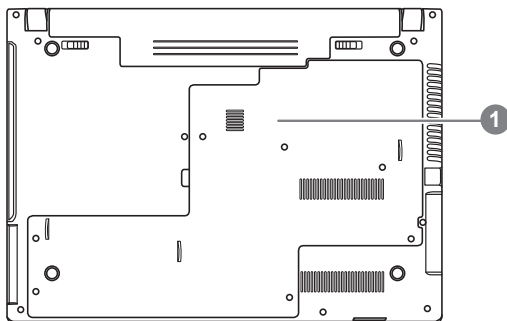

- 1 HDD & Memory Compartment

## 3 Hotkeys

The computer employs hotkeys or key combinations to access most of the computer's controls like screen brightness and volume output. To activate hotkeys, press and hold the <Fn> key before pressing the other key in the hotkey combination.

Hotkey	Function	Description
<b>Fn+F1</b>	Zz Icon	Places the Notebook in suspend mode.
<b>Fn+F2</b>	Wireless LAN/BT	Enables/disables the Wireless LAN/BT function.
<b>Fn+F4</b>	Lightning	Toggles the Notebook between various power management modes.
<b>Fn+F5</b>	Dim Sun	Decreases the display brightness
<b>Fn+F6</b>	Bright Sun	Increases the display brightness
<b>Fn+F7</b>	LCD on & off	Toggles the Display Panel On and off
<b>Fn+F8</b>	LCD /Monitor	Toggles between the Notebook LCD display and an external monitor in this series.
<b>Fn+F9</b>	Crossed-out Touchpad	Toggles the Built-in touchpad LOCKED and UNLOCK.
<b>Fn+F10</b>	Speaker	Toggles the speakers on & off (only in Windows OS)
<b>Fn+F11</b>	Speaker Down	Decrease the speaker volume
<b>Fn+F12</b>	Speaker Up	Increase the speaker volume

## 4 System Setup

Pressing the hot keys to adjust BIOS setup, system recovery and boot option menu.

Hotkey	Function	Description
<b>ESC</b>	BIOS setup	Enter BIOS setup
<b>F9</b>	system recovery	Enter system recovery
<b>F11</b>	boot option	Enter boot option menu

# 5 Recovery Guide

## System Recovery (Restore your laptop operating system)

When something is going wrong with the laptop operating system, the storage of the laptop has a hidden partition containing a full back up image of the operating system that can be used to restore the system to factory default settings.



**Note**

- If the storage has been switched or the partition deleted, the recovery option will no longer be available and a recovery service will be needed.
- The recovery function is only available on devices with O/S preinstalled. Devices with DOS do not have the recovery function.

## Launch System Recovery

The system recovery feature is preinstalled before the laptop is shipped from the factory. The option menu allows you to launch the Windows recovery tool to reinstall the operating system to factory default.

The brief introduction below will show you how to start the recovery tool and restore your system.



**All ready to go**

Make sure your PC is plugged in. This will take a few minutes.

## Windows 7 Recovery Guide

**1** Turn off and restart the laptop.

**2** During the laptop turn on process, press and hold F9 key to launch the tool.



**3** The recovery will be activated and you will see the option buttons on the window. Click on "Recovery" to start it.



**Caution**

Once the "Recovery" is selected, your personal data and files will be deleted after the laptop starts restoring, and the operating system will be reset to factory default settings.

**4** A progress indicator bar will show on the window when the recovery process is running. Please make sure the AC-adaptor is plugged in and do not turn off the laptop.

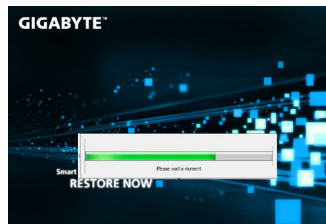

5



Reboot the laptop after the system recovery is complete.

## Windows 8 Recovery Guide

1

Turn off and restart the laptop.

2



During the laptop turn on process, press and hold F9 key to launch the tool.

3

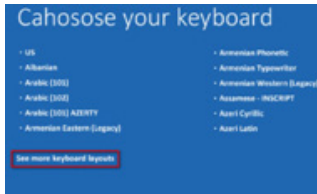

Choose your keyboard layout.

You can press "See more keyboard layouts" to see next page of languages.

4



Choose "Troubleshoot" to enter the recovery settings.

(Also you can choose "Continue" to exit recovery system and continue to Windows 8 for files or data backup.)



### There are two options for system recovery

- **Refresh your PC**

You can refresh your laptop to improve the system stability without losing your files.

- **Reset your PC**

If you want to remove all of your files, you can reset your PC completely.

**Caution: All personal data and files will be lost.**

### ■ **Warranty & Service:**

Warranty and service and related information please refer to the warranty card or GIGABYTE service website as the below link:

<http://www.gigabyte.com/support-downloads/technical-support.aspx>

### ■ **FAQ:**

FAQ (Frequent Asked Questions) please refer to the below link:

<http://www.gigabyte.com/support-downloads/faq.aspx>