

GIGABYTE™

Q2552

USER'S MANUAL

使 用 手 冊

● English

V2.0

Congratulations on your purchase of the GIGABYTE Notebook.

This manual will help you to get started with setting up your notebook. The final product configuration depends on the model at the point of your purchase. GIGABYTE reserves the right to amend without prior notice. For more detailed information, please visit our website at www.gigabyte.com.

Using GIGABYTE Notebook for the First Time

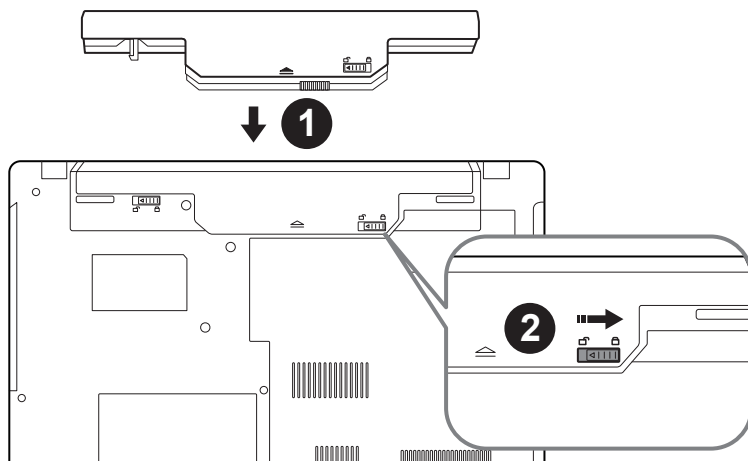

To install the battery please follow these steps:

- 1 Insert the battery pack into the compartment.
- 2 Remember to slide the switch to the "Lock" position.

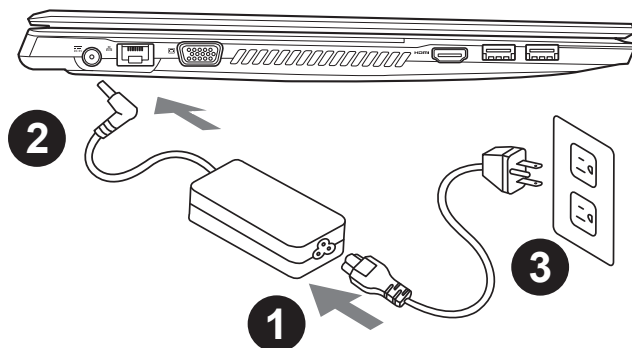

- 1 Connect the the power cord to the AC adapter.
- 2 Connect the AC adapter to the DC-in jack on the right side of the notebook.
- 3 Connect the power cord to the power outlet.

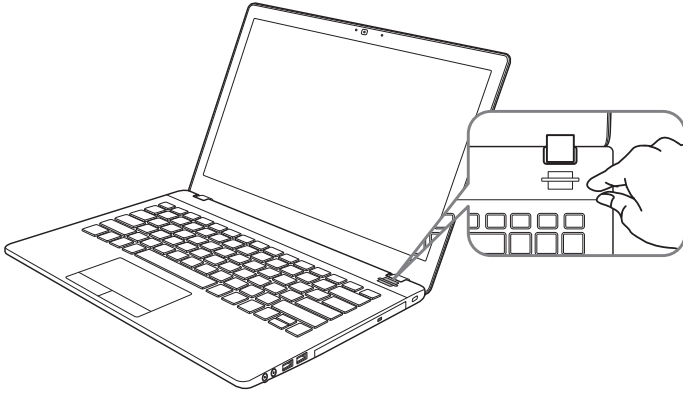

Switching on the Power

After you turn on the Q2552 for the very first time, do not turn it off until the operating system has been configured. Please note that the volume for the audio will not function until Windows® Setup has completed.

Booting Up the Q2552 for the First Time

Depending on your configuration, the Microsoft® Windows® Boot Screen will be the first screen that you will see as the notebook starts up. Follow the on-screen prompts and instructions and enter your personal information to complete the setup of the Windows® Operating System.

Top View

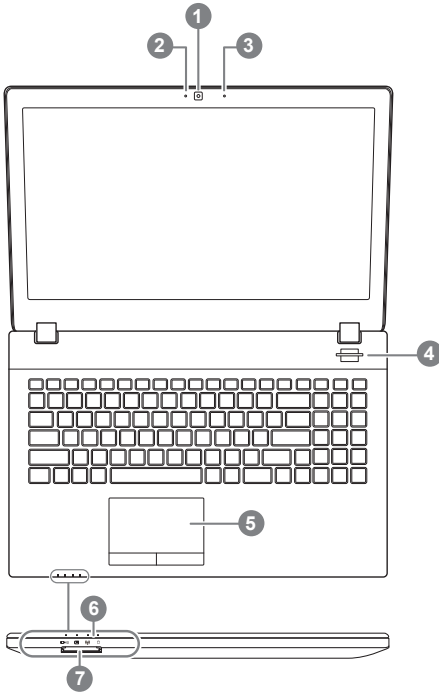

- 1 Webcam
- 2 Webcam on/off Indicator
- 3 Built-In Mic
- 4 Power Button
- 5 Touchpad and buttons
- 6 LED Indicators ①
- 7 Multi-in-1 Card Reader

- ① Power on/Suspend Status
- Battery Status LED
- Airplane Mode Status LED
- HDD Status LED

Left View

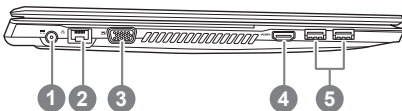

- 1 power DC input
- 2 LAN RJ-45
- 3 External Monitor Port
- 4 HDMI
- 5 USB Port 3.0x2

Right View

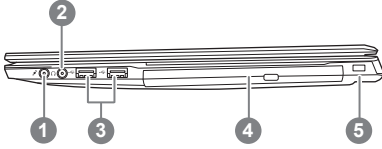

- 1 Microphone input Jack
- 2 Headphone output Jack
- 3 USB Port 2.0x2
- 4 Optical Device Drive Bay
- 5 Kensington Lock Slot



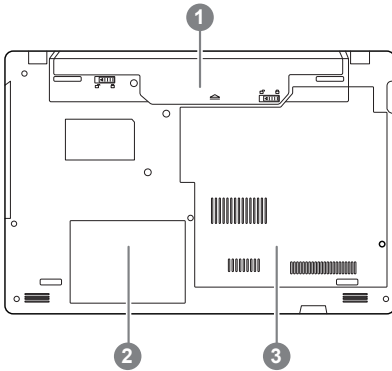



Bottom View



- 1 Battery
- 2 HDD
- 3 Memory Compartment

Hotkeys

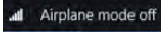
The computer employs hotkeys or key combinations to access most of the computer's controls like screen brightness and volume output. To activate hotkeys, press and hold the <Fn> key before pressing the other key in the hotkey combination.

Hotkey	Description	Icon
Fn+~	Play/ Pause(in Audio/Video Programs)	
Fn+F1	Touchpad Toggle	 
Fn+F2	Turn LCD Backlight OFF (Press a key to or use Tochpad to turn on)	
Fn+F3	Mute Toggle	
Fn+F4	Sleep Toggle	
Fn+F5/F6	Volume Decrease/Increases	
Fn+F7	Display Configuration	
Fn+F8/F9	Bright Decreases/Increases	
Fn+F10	PC Camera Power on and off	 
Fn+F11	Airplane Mode Toggle	 Airplane mode on  Airplane mode off
Fn+ NumLK	Number Lock Toggle	 
Fn+ScrLK	Scroll Lock Toggle	 
Caps Lock	Caps Lock Toggle	 

Smart USB Backup Guide (Original: Recovery Image USB)

⚠ WARNING

- You can backup original recovery image through this application in case of losing by device damage.
- You can backup original recovery image to USB disk and restore the system if any storage system replacement with the recovery USB disk.
- Before you restore the system through the recovery USB disk, please make sure that you have already made the backup of your data.
- Please DO NOT shut down or un-plug the system when performing backup through recovery USB disk.

1



- Please plug in the USB disk which is at least 20GB in capacity to make the original image (backup the data in USB first. All data will be eliminated during the creation of recovery USB disk)

2



- Insert the driver disk to your optical drive and run the install of "Smart USB Backup" (for none-ODD model, please use USB ODD device or download from <http://www.gigabyte.com>)

3



- Run the "Smart USB Backup" after finishing the install.

4



- Select your USB disk from the drop-down list and start to create the recovery USB disk.

5

- The window will pop out when the creation of recovery disk is done.
- Please press F12 on starting the system when you need to restore the system. Select "boot from recovery USB disk" and the system will be restored.
- The time needed for restore will be around 30 mins(time needed may vary by USB disk model) .

Recovery Guide

System Recovery (Restore your laptop operating system)

When something is going wrong with the laptop operating system, the storage of the laptop has a hidden partition containing a full back up image of the operating system that can be used to restore the system to factory default settings.



Note

- If the storage has been switched or the partition deleted, the recovery option will no longer be available and a recovery service will be needed.
- The recovery function is only available on devices with O/S preinstalled. Devices with DOS do not have the recovery function.

Launch System Recovery

The system recovery feature is preinstalled before the laptop is shipped from the factory. The option menu allows you to launch the Windows recovery tool to reinstall the operating system to factory default.

The brief introduction below will show you how to start the recovery tool and restore your system.



All ready to go

Make sure your PC is plugged in. This will take a few minutes.

Windows 7 Recovery Guide

1 Turn off and restart the laptop.

2



During the laptop turn on process, press and hold F9 key to launch the tool.

3



The recovery will be activated and you will see the option buttons on the window. Click on "Recovery" to start it.



Caution

Once the "Recovery" is selected, your personal data and files will be deleted after the laptop starts restoring, and the operating system will be reset to factory default settings.

4

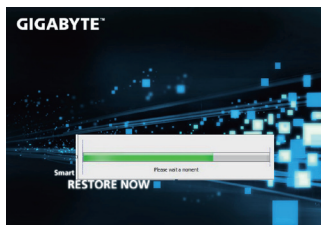

A progress indicator bar will show on the window when the recovery process is running. Please make sure the AC-adaptor is plugged in and do not turn off the laptop.

5



Reboot the laptop after the system recovery is complete.

Windows 8 Recovery Guide

1

Turn off and restart the laptop.

2



During the laptop turn on process, press and hold F9 key to launch the tool.

3

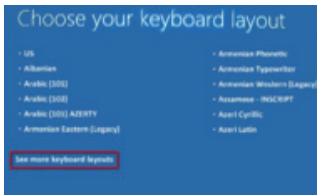

Choose your keyboard layout.

You can press "See more keyboard layouts" to see next page of languages.

4



Choose "Troubleshoot" to enter the recovery settings.

(Also you can choose "Continue" to exit recovery system and continue to Windows 8 for files or data backup.)



There are two options for system recovery

- **Refresh your PC**

You can refresh your laptop to improve the system stability without losing your files.

- **Reset your PC**

If you want to remove all of your files, you can reset your PC completely.

Caution: All personal data and files will be lost.

5



■ Choose “Refresh your PC”

[Click on “Next”] > [Choose a target operating system.] > [Click on “Windows 8”.] > [Click on “Refresh” to execute recovery function.]



Here are what will happen

- Your files and personalization settings won't be changed.
- Your PC settings will be restored to factory default settings.
- Apps from Windows Store will be kept.
- Apps you installed from discs or websites will be removed.
- A list of removed apps will be saved on your desktop.



■ Choose “Reset your PC”

[Click on “Next”] > [Choose a target operating system.] > [Click on “Windows 8”.] > [Choose an option to recover your system]

► Just remove my files

Only personal data and files will be removed, but computer settings will be kept.

► Fully clean the drive

The drive will be completely restored to factory default settings. It takes more time. > [Click on “Reset” to execute recovery function.]



Here are what will happen

- All of your personal files and apps will be removed.
- Your PC settings will be restored to factory default settings.



■ Advanced options



System Restore

Use a restore point recorded on your PC to restore Windows.



System Image Recovery

Recover Windows using a specific system image file.



Automatic Repair

Fix problems that keep Windows from loading.



Command Prompt

Use the Command Prompt for advanced troubleshooting.



UEFI Firmware Settings

Change settings in your PC's UEFI firmware.

Windows 8.1 Recovery Guide

1 Turn off and restart the laptop.

2



During the laptop turn on process, press and hold F9 key to launch the tool.

3



Choose “Troubleshoot” to enter the recovery settings. (Also you can choose “Continue” to exit recovery system and continue to Windows 8.1 for files or data backup.)



There are two options for system recovery

- **Refresh your PC**

You can refresh your laptop to improve the system stability without losing your files.

- **Reset your PC**

If you want to remove all of your files, you can reset your PC completely.

Caution: All personal data and files will be lost.

4



■ Choose “Refresh your PC”

Choose an account to continue.



Here are what will happen

- Your files and personalization settings won't be changed.
- Your PC settings will be restored to factory default settings.
- Apps from Windows Store will be kept.
- Apps you installed from discs or websites will be removed.
- A list of removed apps will be saved on your desktop.



■ Choose “Reset your PC”

► Just remove my files

Only personal data and files will be removed, but computer settings will be kept.

► Fully clean the drive

The drive will be completely restored to factory default settings. It takes more time. > [Click on “Reset” to execute recovery function.]



Here are what will happen

- All of your personal files and apps will be removed.
- Your PC settings will be restored to factory default settings.



■ Advanced options



System Restore

Use a restore point recorded on your PC to restore Windows.



System Image Recovery

Recover Windows using a specific system image file.



Automatic Repair

Fix problems that keep Windows from loading.



Command Prompt

Use the Command Prompt for advanced troubleshooting.



UEFI Firmware Settings

Change settings in your PC's UEFI firmware.



Startup Settings

Change Windows Startup behavior.

Appendix

■ **Warranty & Service:**

Warranty and service and related information please refer to the warranty card or GIGABYTE service website as the below link:

<http://www.gigabyte.com/support-downloads/technical-support.aspx>

■ **FAQ:**

FAQ (Frequent Asked Questions) please refer to the below link:

<http://www.gigabyte.com/support-downloads/faq.aspx>