

# P55 USER'S MANUAL

使 用 手 冊

- English
- 繁體中文
- 简体中文
- 한국어
- Español
- Deutsch
- Français
- Italiano
- Indonesia
- Čeština
- Русский

## Congratulations on your purchase of the GIGABYTE Notebook.

This manual will help you to get started with setting up your notebook. The final product configuration depends on the model at the point of your purchase. GIGABYTE reserves the right to amend without prior notice. For more detailed information, please visit our website at [www.gigabyte.com](http://www.gigabyte.com)

## Using GIGABYTE Notebook for the First Time

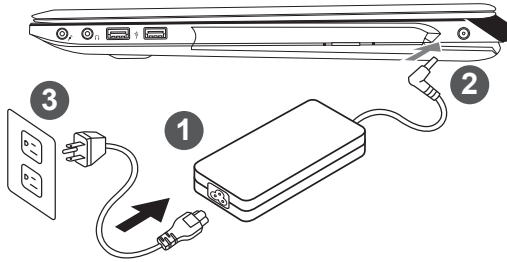

- 1 Connect the power cord to the AC adapter.
- 2 Connect the AC adapter to the DC-in jack on the right side of the notebook.
- 3 Connect the power cord to the power outlet.

### IMPORTANT

- Ensure that your Notebook PC is connected to a grounded power adapter before turning it on for the first time.
- When using your Notebook PC on power adapter mode, the socket outlet must be near to the unit and easily accessible.
- Locate the input/output rating label on your Notebook PC and ensure that it matches the input/output rating information on your power adapter. Some Notebook PC models may have multiple rating output currents based on the available SKU.
- Power adapter information: Input voltage: 100-240Vac, - Input frequency: 50-60Hz, - Rating output voltage: 19.5V, 9.23A or 19.5V, 10.3A

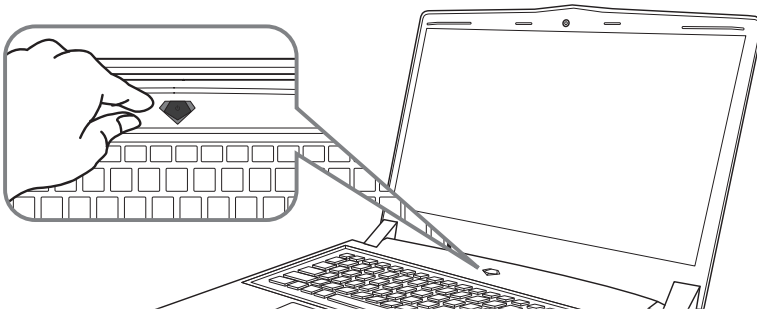

## Switching on the Power

After you turn on the Notebook for the very first time, do not turn it off until the operating system has been configured. Please note that the volume for the audio will not function until Windows® Setup has completed.



## Booting Up the Notebook for the First Time

Depending on your configuration, the Microsoft® Windows® Boot Screen will be the first screen that you will see as the notebook starts up. Follow the on-screen prompts and instructions and enter your personal information to complete the setup of the Windows® Operating System.

# Your GIGABYTE Notebook Tour

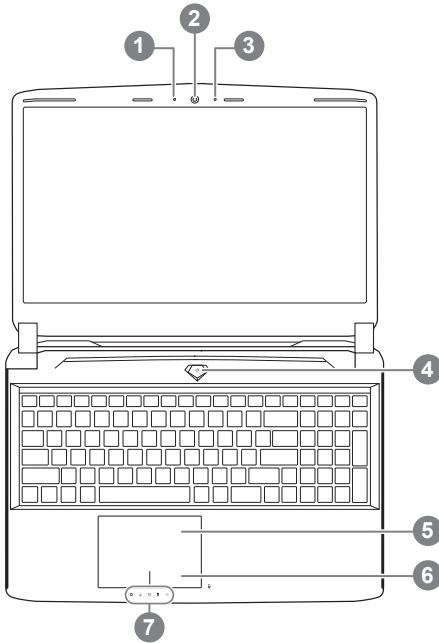
## Top View





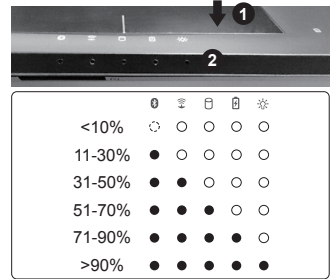

- 1 Webcam Status LED Indicator
- 2 Webcam
- 3 Microphone
- 4 Power Button
- 5 TouchPad
- 6 Battery Indicator Button 
- 7 LED Indicators 

- 1** Right-click to show the remaining power percentage.

As shown below, the battery life indicator is available when the laptop is shut down, in stand-by or hibernation. (Battery mode)



- 2**  Bluetooth Status LED  
 Wireless Lan Status LED  
 HDD Status LED  
 Battery Status LED  
 Power Status LED

## Left View

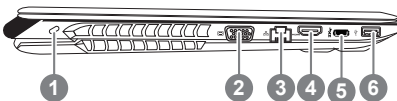

- 1 Kensington Lock Slot
- 2 D-sub (VGA) Port
- 3 Ethernet Port
- 4 HDMI Port
- 5 USB 3.1
- 6 USB 3.0

## Right View

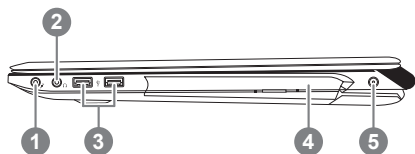

- 1 Microphone Jack
- 2 Headphone Jack
- 3 USB 3.0
- 4 Optical Disc Drive
- 5 DC-in Jack

## Base View

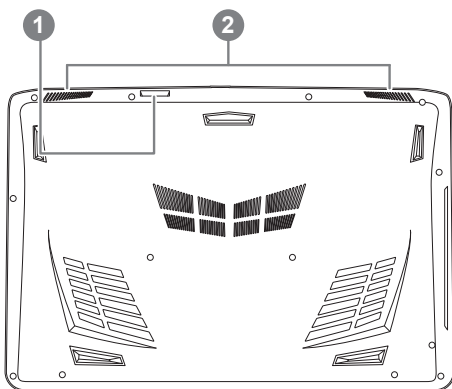

- 1 SD Card Reader
- 2 Speakers















### Warning:

DO NOT remove the built-in lithium battery. For any service needs, please contact your local GIGABYTE Authorized Service Center.

- Do not install the Notebook PC on a slant or a place prone to vibrations, or avoid using the Notebook PC in that location for a long time. This increases the risk that a malfunction or damage to the product will occur.
- Do not store and use Notebook PC in direct sunlight or the location where temperatures exceed 112°F (45°C) such as inside a vehicle. There is a danger of Lithium-ion battery expansion and aging.
- Do not use the Notebook PC in a badly ventilated location such as on bedding, on a pillow or cushion, etc, and do not use it in a location such as room with floor heating as it may cause the computer to overheat. Take care that the Notebook PC vents (on the side or the bottom) are not blocked especially in these environments. If the vents are blocked, it may be dangerous and cause the Notebook PC to overheat.

# Hotkeys

The computer employs hotkeys or key combinations to access most of the computer's controls like screen brightness and volume output. To activate hotkeys, press and hold the <Fn> key before pressing the other key in the hotkey combination.

Hotkey	Function	Description
 Fn + ~	Playback	Media Playback control.
 Fn + F1	Touchpad Toggle	Turn the internal touchpad ON/OFF
 Fn + F2	LCD Toggle	Turn LCD OFF (Press a key to or use TouchPad to turn on)
 Fn + F3	Speaker Toggle	Turn the speaker ON/OFF
 Fn + F4	Sleep Toggle	Put the computer in Sleep mode
 Fn + F5	Volume Down	Decrease the sound Volume
 Fn + F6	Volume Up	Increase the sound Volume
 Fn + F7	Display Toggle	Switch display output between the display screen , external monitor (if connected) and both.
 Fn + F8	Brightness Down	Decrease the screen brightness
 Fn + F9	Brightness Up	Increase the screen brightness
 Fn + F10	Webcam	Turn the internal webcam ON/OFF.
 Fn + F11	Airplane Mode Toggle	Turn the Airplane Mode ON/OFF *This function is only available in certain region
 Fn + F12	Keyboard Backlight Toggle	Turn the keyboard backlight ON/OFF

## ■ GIGABYTE Smart Manager

You can activate GIGABYTE Smart Manager by double clicking on the shortcut icon on the desktop if the machine you purchased has the operation system built-in. GIGABYTE Smart Manager is an icon-based control interface, enabling users to intuitively access common system setup as well as GIGABYTE exclusive utilities. Please be noted that the GIGABYTE Smart Manager interface, icons, utilities and software versions may vary based on the purchased models. Please operate GIGABYTE Smart Manager according to the actual version built-in.

# Smart USB Backup Guide (Original: Recovery Image USB)

## ⚠ WARNING

- You can backup original recovery image through this application in case of losing by device damage.
- You can backup original recovery image to USB disk and restore the system if any storage system replacement with the recovery USB disk.
- Before you restore the system through the recovery USB disk, please make sure that you have already made the backup of your data.
- Please DO NOT shut down or un-plug the system when performing backup through recovery USB disk.

1



- Please plug in the USB disk which is at least 20GB in capacity to make the original image (backup the data in USB first. All data will be eliminated during the creation of recovery USB disk)

2



- Insert the driver disk to your optical drive and run the install of “Smart USB Backup” (for none-ODD model, please use USB ODD device or download from <http://www.gigabyte.com>)

3



- Run the “Smart USB Backup” after finishing the install.

4



- Select your USB disk from the drop-down list and start to create the recovery USB disk.

5

- The window will pop out when the creation of recovery disk is done.
- Please press F12 on starting the system when you need to restore the system. Select “boot from recovery USB disk” and the system will be restored.
- The time needed for restore will be around 30 mins(time needed may vary by USB disk model) .

# Recovery Guide

## System Recovery (Restore your laptop operating system)

When something is going wrong with the laptop operating system, the storage of the laptop has a hidden partition containing a full back up image of the operating system that can be used to restore the system to factory default settings.



### Note

- If the storage has been switched or the partition deleted, the recovery option will no longer be available and a recovery service will be needed.
- The recovery function is only available on devices with O/S preinstalled. Devices with DOS do not have the recovery function.

## Launch System Recovery

The system recovery feature is preinstalled before the laptop is shipped from the factory. The option menu allows you to launch the Windows recovery tool to reinstall the operating system to factory default.

The brief introduction below will show you how to start the recovery tool and restore your system.



### All ready to go

Make sure your PC is plugged in. This will take a few minutes.

## Windows 10 Recovery Guide

**1**

Turn off and restart the laptop.

**2**

During the laptop turn on process, press and hold F9 key to launch the tool.

**3**

Choose “Troubleshoot” to enter the recovery settings. (Also you can choose “Continue” to exit recovery system and continue to Windows 10 for files or data backup.)



### There are two options for system recovery

- **Reset this PC**  
You can choose to keep or remove your files and then reinstalls Windows without losing your files.
- **GIGABYTE Smart Recovery**  
Your PC settings will be restored to factory default settings.  
**Caution: All personal data and files will be lost.**



## 4



### ■ Choose “Reset this PC”

#### ▶ Keep my files

Choose an account to continue. All apps will be removed, and settings will back to pure O/S (without GIGABYTE app), but your personal files will be kept.

#### ▶ Remove everything

All apps, setting and personal files will be removed.

#### ⇒ Just remove my files

Only personal data and files will be removed, but computer settings will be kept.

#### ⇒ Fully clean the drive

The drive will be completely restored to factory default settings. It takes more time. > [Click on “Reset” to execute recovery function.]



### Here are what will happen

- All of your personal files and apps will be removed.
- Your PC settings will be restored to pure O/S (without GIGABYTE app) .



### ■ GIGABYTE Smart Recovery



The recovery will be activated and you will see the option buttons on the window. Click on “Yes” to start it.



### Caution

- Once the “Recovery” is selected, your personal data and files will be deleted after the laptop starts restoring, and the operating system will be reset to factory default settings.
- A progress indicator bar will show on the window when the recovery process is running. Please make sure the AC-adapter is plugged in and do not turn off the laptop.



After the system recovery is completed, you will see the option button on the window, please click on “Shutdown”.



## ■ Advanced options



### **System Restore**

Use a restore point recorded on your PC to restore Windows.



### **System Image Recovery**

Recover Windows using a specific system image file.



### **Startup Repair**

Fix problems that keep Windows from loading.



### **Command Prompt**

Use the Command Prompt for advanced troubleshooting.



### **UEFI Firmware Settings**

Change settings in your PC's UEFI firmware.



### **Startup Settings**

Change Windows Startup behavior.

# Installing the Thermal Pad for M.2 SSD on P55

If you want to install M.2 SSD on your P55, we strongly recommend that you should read this instruction first in order not to installation fail. We(GIGABYTE) won't be responsible for any damage from installation of SSD either by individual or vendor. So please RE-CONSIDER it before installation, thanks!

1

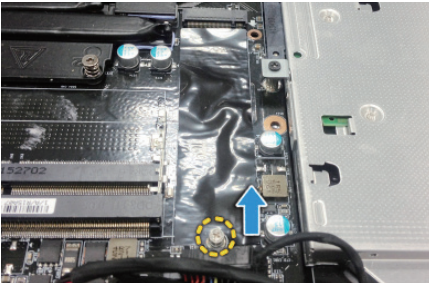

- Open the rear cover and loose the screw for M.2 SSD

2



- Tear the transparent film on the thermal pad

3-1



- To paste the thermal pad on the top of M.2 SSD and aligned with the chip on the right side, then tear the blue film.

3-2



4-1



4-2



- Insert the SSD to M.2 slot and tighten the screw.

**⚠ CAUTION**

- GIGABYTE will take no responsibility for any customer induced damages during installing. We suggest that you send your notebook to an authorized GIGABYTE service center if any question. Making any charges depends on local conditions.  
Website: <http://www.gigabyte.com/index.aspx>

## Appendix

### ■ **Warranty & Service:**

Warranty and service and related information please refer to the warranty card or GIGABYTE service website as the below link:

<http://www.gigabyte.com/support-downloads/technical-support.aspx>

### ■ **FAQ:**

FAQ (Frequent Asked Questions) please refer to the below link:

<http://www.gigabyte.com/support-downloads/faq.aspx>

### ■ **Full User Manual:**

For more user guide and software instruction, please refer to the below link:

<http://www.gigabyte.com/support-downloads/download-center.aspx>

## 感謝您選擇技嘉筆記型電腦！

為協助您順利使用技嘉筆記型電腦，我們特地設計此快速安裝說明。如果您需要更多關於電腦功能，歡迎上技嘉官方網站 [www.gigabyte.tw](http://www.gigabyte.tw) 查詢。產品實際規格以出貨為準，如有異動恕不另行通知。

## 首次使用 GIGABYTE 技嘉筆記型電腦

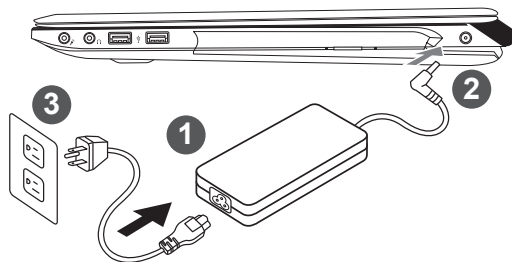

- 1 將電源線接上電源轉換器。
- 2 將電源轉換器連接到電腦的電源插孔。
- 3 將電源線插入電源插座。

### ⚠ 重要

- 第一次啟動筆記型電腦之前，請先確認已經將電源變壓器連接至電腦。
- 找出筆記型電腦的輸入/輸出頻率標籤，並請確認符合電源變壓器上的輸入/輸出頻率資訊。
- 當筆記型電腦在電源變壓器使用模式時，請將電源變壓器靠近插座以方便於使用。
- 電源變壓器資訊：輸入電壓：100-240Vac，輸入頻率：50-60Hz，輸出電壓功率：19.5V, 9.23A or 19.5V, 10.3A



## 開啟筆記型電腦

電源指示燈會顯示機器是否為通電的狀態。

第一次開機時，在還未完全進入作業系統前請勿強制關機。開啟電源後，直到該作業系統配置完成前，音量無法設定。

## 開始第一次使用

根據您的筆記型電腦配置，當您第一次開機，第一個畫面會是微軟Windows® 啟動畫面，按照該螢幕上的提示和指示，完成作業系統的配置。當軟體許可條款顯示時，請務必閱讀並同意後再繼續。

# GIGABYTE技嘉筆記型電腦導覽

2

繁體中文

## 上視圖

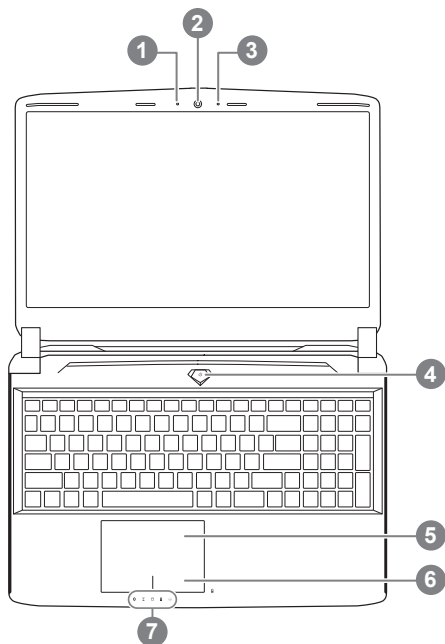

- 1 視訊指示燈
- 2 視訊攝影機
- 3 麥克風
- 4 電源開關
- 5 觸控板
- 6 電池電量顯示鍵 ①
- 7 LED 狀態指示燈 ②

① 在關機/待命/休眠模式時按下右鍵可透過指示燈號檢視電池剩餘電量(電量對照如下圖)(電池模式下)

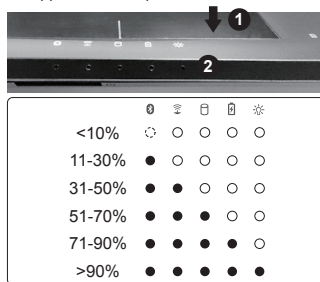

警語：使用過度恐傷害視力。

注意事項：

(1)使用30分鐘請休息10分鐘。

(2)2歲以下幼兒不看螢幕，2歲以上每天看螢幕不要超過1小時。

- ② ③ 藍牙指示燈  
④ 無線網路指示燈  
⑤ 硬碟存取指示燈  
⑥ 電池充電指示燈  
※ 電源狀態指示燈

## 左視圖

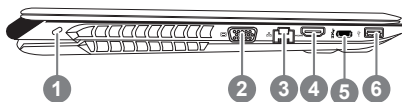

- 1 Kensington防盜鎖孔
- 2 外接顯示器 (VGA) 埠
- 3 乙太網路(LAN)埠
- 4 HDMI 埠
- 5 USB 3.1
- 6 USB 3.0

## 右視圖

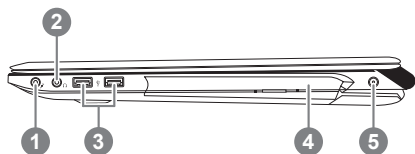

- 1 麥克風插孔
- 2 耳機插孔
- 3 USB 3.0
- 4 光碟機
- 5 電源插孔

## 底視圖

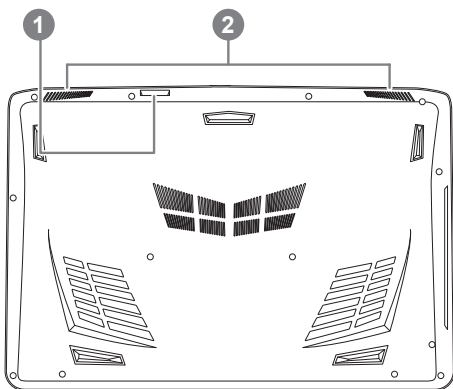

- 1 SD記憶卡讀卡機
- 2 喇叭



### 警告：

本機器設備配備的鋰電池為不可拆卸裝置，請交由技嘉授權專業維修服務中心移除裝置中的電池。

- 請不要於斜面上或容易震動的地方使用筆記型電腦，以降低發生故障和產品損壞的風險。
- 請勿置於車內、室內外陽光強烈或高於45度C之儲藏環境，以免鋰電池發生老化或膨脹等危險。
- 請於通風良好的地方使用此產品。請勿在床上、枕頭等通風不良的地方使用此產品，並且不要在有樓板暖氣的地方使用，避免導致筆記型電腦過熱。請避免底部和側邊的通風孔阻塞。如果通風孔阻塞，會有損害筆記型電腦或導致內部過熱的危險。



# 快速鍵

許多電腦的設定例如螢幕亮度、喇叭音量等可利用電腦的快速鍵直接調整。如需使用快速鍵，請依下表先按住<Fn>鍵，再按下<F1>~<F12>等按鍵。

快速鍵	功能	功能敘述
 Fn + ~	媒體控制鍵	控制多媒體播放、暫停等功能。
 Fn + F1	觸控板開關	開啟/關閉觸控板。
 Fn + F2	顯示器關閉	關閉顯示器。 (按任意鍵或使用觸控板可開啟)
 Fn + F3	喇叭靜音	將喇叭切換為靜音模式。
 Fn + F4	睡眠模式	讓電腦進入睡眠模式。
 Fn + F5	減弱音量	降低喇叭音量。
 Fn + F6	增大音量	提高喇叭音量。
 Fn + F7	螢幕顯示切換	在電腦螢幕以及外接顯示器之間切換影像輸出，或者同時顯示。
 Fn + F8	減弱亮度	降低螢幕亮度。
 Fn + F9	增強亮度	提高螢幕亮度。
 Fn + F10	視訊攝影機	開啟/關閉內建視訊攝影機。
 Fn + F11	飛航模式	開啟/關閉飛航模式。 *此功能僅在特定國家方可使用
 Fn + F12	鍵盤背光開關	開啟/關閉鍵盤背光。

(以下各軟體使用介面、圖示及功能可隨您購買的機種、軟體版本而有所變更。)

## ■ GIGABYTE Smart Manager

若您購買的電腦出貨已搭載Windows® 作業系統，您可在桌面上雙擊Smart Manager捷徑圖示啟動GIGABYTE Smart Manager軟體，透過Smart Manager簡易的圖示介面，可以輕鬆校調系統的相關設定。請注意Smart Manager使用介面、圖示及功能將隨您購買的機種、軟體版本而有所變更，使用方式請依實際所搭載的Smart Manager版本操作。

# Smart USB Backup 使用說明(原Recovery Image USB)

6

每  
系  
體  
中  
文

## 警告

- 為避免儲存裝置毀損導致原廠的還原映像檔遺失，您可以透過此軟體來備份原廠的還原映像檔
- 如果您想更換新的儲存裝置，您可以透過此軟體將原廠還原映像檔備份至 USB 隨身碟，安裝好新的儲存裝置後，再將出廠的預設系統倒回新儲存裝置。
- 使用本軟體所製作的還原 USB 隨身碟 將系統還原以前，請先做好資料備份，以免資料流失。
- 利用還原 USB 隨身碟進行系統還原時，請勿移除或關掉電源。

1



- 若要製作原廠映像檔的還原 USB 隨身碟，請先插入容量至少有 20GB 的 USB 隨身碟 (請先將 USB 隨身碟裡原有的資料備份，避免因下述操作造成 USB 隨身碟裡的資料遺失)

2



- 放入驅動程式光碟，執行安裝” Smart USB Backup”。(無內建光碟機的機種，請外接 USB 光碟機；若光碟內沒有軟體，請上 <http://www.gigabyte.com> 下載)。

3



- 安裝完成後，執行桌面上的” Smart USB Backup”。

4



- 從清單中選取剛剛插入的 USB 隨身碟，然後選擇建立還原 USB。

5

- 跳出結束視窗後即完成。
- 若要還原您的系統，請在開機時按 F12，選擇用【USB 隨身碟開機】，【USB 隨身碟】會自動完成還原您的系統。
- 還原時間約需 30 分鐘 (所需時間會因 USB 隨身碟種類而有所不同)。

# 系統還原使用說明

## 系統還原（修復您的筆記型電腦作業系統）

當作業系統使用上出現不穩定的情況，筆記型電腦原廠出貨的儲存裝置裡有一個隱藏磁區，其內容為作業系統的完整備份映像檔，可以用來救援系統將儲存裝置裡的作業系統還原到出廠預設值。



### 注意

- 如果儲存裝置有被更換過或刪除該隱藏磁區，還原功能將無法使用，需送維修中心還原。
- 出廠規格為預搭作業系統時才有此還原功能，若是 DOS 銷售則不提供此功能。

## 啟動系統還原

系統還原功能是筆記型電腦出廠時被預先安裝的。該選項可以啟動 Windows 故障還原工具，重新安裝作業系統為出廠預設值。

以下為簡要介紹如何啟動還原工具，並開始還原系統。



### 執行還原前請注意

確認筆記型電腦已接上外接電源，還原系統會花費幾分鐘的時間。

## Windows 10 系統還原說明

1

關機並重新啟動筆記型電腦。

2



啟動筆記型電腦後，按著 F9 按鍵幾秒鐘以啟動還原工具。

3



選擇“Troubleshoot”進入系統還原及進階選項。

（您也可以選擇“Continue”直接進入 Windows 10 作業系統，先行備份個人資料與檔案再作還原。或選擇“Turn off your PC”關機並重新啟動筆記型電腦。）



### 系統還原有兩種方式可供選擇

- **Reset this PC**  
如果電腦因軟體或設定值不佳而不穩定，您可以選擇移除或保留個人資料，在重設電腦設定值而不遺失個人資料。
- **GIGABYTE Smart Recovery**  
筆記型電腦的設定值會被還原成出廠預設值。  
**注意：**將會遺失所有的個人資料與檔案。

## 4



## Reset this PC - 重設電腦設定值

### ► Keep my files - 保留個人檔案

選擇一個使用者帳戶後繼續。所有應用程式會被移除，設定值會還原成單純的 O/S (不含 GIGABYTE 應用程式)，但個人檔案會被保留。

### ► Remove everything - 移除所有項目

所有應用程式、設定值和個人檔案將會被移除。

#### ⇒ Just remove my files - 只移除個人檔案

只移除個人檔案，但保留電腦設定值。

#### ⇒ Fully clean the drive - 完整還原

完整還原儲存裝置至出廠設定值，會花費較長的還原時間。

>【按下“Reset”執行】。



### 注意事項

- 您所有的個人檔案與應用程式將會被移除。
- 所有的電腦設定值將會被還原成單純的 O/S (不含 GIGABYTE 應用程式)。



## GIGABYTE Smart Recovery



進入重置系統模式，工具列會有還原選項，如您確定要系統還原，點選“是”執行。



### 注意事項

- 一選擇還原後，所有原本的個人資料與檔案將被刪除，並還原系統及儲存裝置至出廠預設值。
- 還原視窗開啟並進行系統還原，在這之時請確認接上變壓器確保電力無虞，並請勿關閉電源。

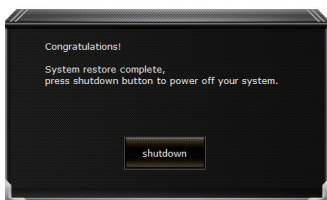

當系統還原完成後，工具列會有選項，請點選“關機”



## ■ Advanced options 其它或進階選項

更多系統還原的進階設定。



### System Restore 系統還原

選擇系統還原的記錄時間，將系統還原至該時間點。



### System Image Recovery 系統備份還原

使用之前備份的系統備份資料還原 Windows 系統。



### Startup Repair 啟動修復程序

修復及解決 Windows 系統問題。



### Command Prompt 命令提示字元

使用命令字元集執行進階的疑難排解。



### UEFI Firmware SettingsUEFI BIOS 設定

重新啟動，變更 UEFI BIOS 設定值。



### Startup Settings 啟動設置

變更 Windows 啟動設定。

# P55 M.2 SSD 散熱墊安裝流程

10

繁體中文

若您要對您的P55安裝M.2 SSD，我們強烈建議您先閱讀過此份說明，以免造成安裝失敗。另本公司不會負責任何經由個人或是經銷商安裝M.2 SSD所造成的損壞賠償，故請您在安裝前考慮清楚，謝謝。

1



- 打開背蓋並解開 M.2 SSD 螺絲。

2



- 取出 P55 隨附的散熱墊撕下透明貼膜黏貼在 M.2 SSD 上。

3-1



- 黏貼時請注意 M.2 SSD 上晶片相對位置，並將散熱墊貼齊最右邊的晶片上方，撕下藍色貼膜。

3-2



4-1



4-2



- 將您的 M.2 SSD 傾斜 45 度角插回至系統中的 M.2 插槽，並鎖上螺絲。

 注意

- 在自行安裝過程中有任何損壞一概不負責。建議您可將機台帶至 GIGABYTE 維修中心，由專業人員為您安裝。參考服務據點：<http://service.gigabyte.tw/>  
有任何問題請洽詢技術服務專線：0800-079-800 (或撥 02-8665-2646)



### ■ 保固及客服資訊：

相關保固條款及客服資訊請參考隨貨所附之保固保證書，或參考技嘉技術服務區網站。

<http://www.gigabyte.tw/support-downloads/technical-support.aspx>

### ■ FAQ：

相關常見問題請參考技嘉常見問題網站。

<http://www.gigabyte.tw/support-downloads/faq.aspx>

### ■ 完整使用說明書：

詳細筆電使用說明與軟體操作說明，請至技嘉 Download-Center 下載電子說明書。

<http://www.gigabyte.com/support-downloads/download-center.aspx>

## 感谢您选择技嘉笔记本电脑！

为协助您顺利使用技嘉笔记本电脑，我们特地设计此快速安装说明。如果您需要更多关于电脑功能，欢迎上技嘉官方网站www.gigabyte.cn查询。产品实际规格以出货为准，如有异动恕不另行通知。

# 首次使用GIGABYTE技嘉笔记本电脑

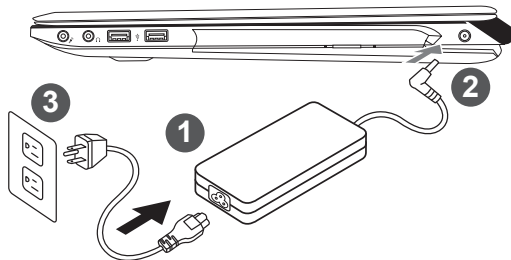

- 1 将电源线接上电源适配器。
- 2 将电源适配器连接到电脑的电源插孔。
- 3 将电源线插入电源插座。

### ⚠ 重要

- 第一次启动笔记本电脑之前，请先确认已经将电源变压器连接至计算机。
- 找出笔记本电脑的输入/输出频率标签，并请确认符合电源变压器上的输入/输出频率信息。
- 当笔记本电脑在电源变压器使用模式时，请将电源适配器靠近插座以便于使用。
- 电源适配器信息：输入电压：100-240Vac，输入频率：50-60Hz，输出电压功率：19.5V, 9.23A or 19.5V, 10.3A



## 开启笔记本电脑

电源指示灯会显示机器是否为通电的状态。

第一次开机时，在还未完全进入作业系统前请勿强制关机。开启电源后，直到该操作系统配置完成前，音量无法设定。

## 开始第一次使用

根据您的笔记本电脑配置，当您第一次开机，第一个画面会是微软Windows® 启动画面，按照该屏幕上的提示和指示，完成操作系统的配置。当软件许可条款显示时，请务必开读并同意后在继续。

# GIGABYTE技嘉笔记型电脑导览

## 上视图

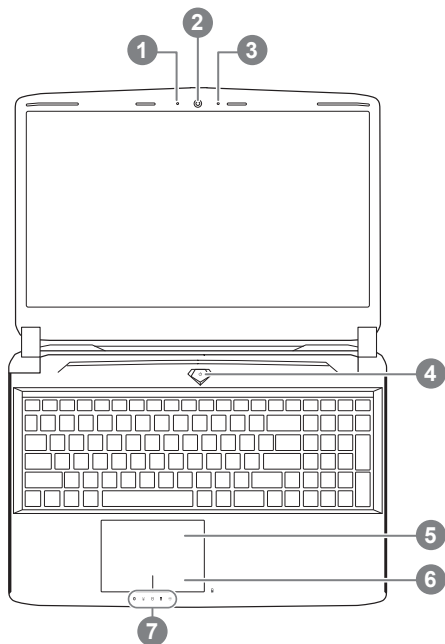

1 摄像头指示灯

2 摄像头

3 内置麦克风

4 电源开关

5 触摸板

6 电池电量显示键 ①

7 LED 状态指示灯 ②

① 按下右键可检视电池剩余电量。在关机/待命/休眠模式时按下右键可透过指示灯号检视电池剩余电量(电量对照如下图)(电池模式下)

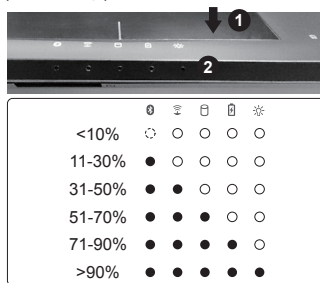

② ① 蓝牙指示灯

② 无线网络指示灯

③ 硬盘存取指示灯

④ 电池充电指示灯

⑤ 电源状态指示灯

## 左视图

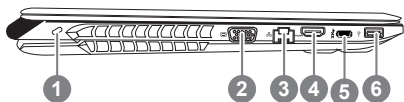

1 Kensington防盗锁孔

2 外接显示器(VGA) 端口

3 有线网卡(LAN)端口

4 HDMI 端口

5 USB 3.1

6 USB 3.0

## 右视图

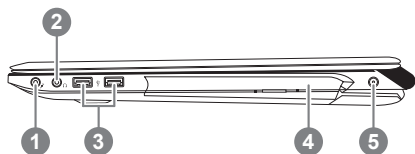

- 1 麦克风插孔
- 2 耳机插孔
- 3 USB 3.0
- 4 光驱
- 5 电源插孔

## 底视图

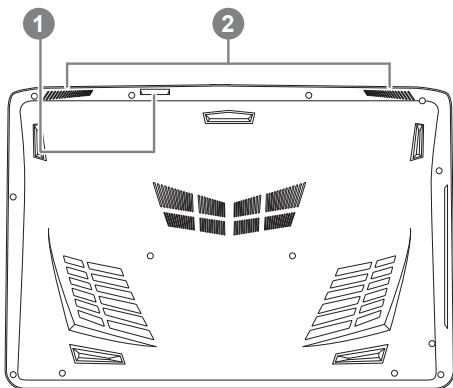

- 1 SD内存卡读卡器
- 2 扬声器











## 警告：

本机器设备配备的锂电池为不可拆卸装置，请交由技嘉授权专业维修服务中心移除装置中的电池。

- 请不要于斜面上或容易震动的地方使用笔记型电脑，以降低发生故障和产品损坏的风险。
- 请勿置于车内、室内外阳光强烈或高于45度C之储藏环境，以免锂电池发生老化或膨胀等危险。
- 请于通风良好的地方使用此产品。请勿在床上、枕头等通风不良的地方使用此产品，并且不要在有楼板暖气的地方使用，避免导致笔记型电脑过热。请避免底部和侧边的通风孔阻塞。如果通风孔阻塞，会有损害笔记型电脑或导致内部过热的危险。

# 快速键

许多电脑的设定例如屏幕亮度，喇叭音量等可利用电脑的快速键直接调整。如需使用快速键，请依下表先按住<Fn>键，再按下<F1>~<F12>等按键。

快速键	功能	功能叙述
 Fn + ~	媒体控制键	控制多媒体播放，暂停等功能
 Fn + F1	触摸板开关	开启/关闭触摸板
 Fn + F2	显示器关闭	关闭显示器。 (按任意键或使用触摸板可开启)
 Fn + F3	扬声器静音	将扬声器切换为静音模式。
 Fn + F4	睡眠模式	让电脑进入睡眠模式。
 Fn + F5	减弱音量	降低扬声器音量。
 Fn + F6	增大音量	提高扬声器音量。
 Fn + F7	屏幕显示切换	在电脑屏幕以及外接显示器或显示器之间切换视频输出，或者同时显示。
 Fn + F8	减弱亮度	降低屏幕亮度。
 Fn + F9	屏幕亮度	提高屏幕亮度。
 Fn + F10	摄像头	开启/关闭内建摄像头。
 Fn + F11	飞行模式	开启/关闭飞行模式 *此功能仅在特定国家/地区可用
 Fn + F12	键盘背光开关	调整键盘背光亮度。

(以下各软件使用介面、图示及功能可随您购买的机种、软件版本而有所变更。)

## ■ GIGABYTE Smart Manager

您购买的电脑出货已搭载 Windows® 操作系统，你可在桌面上双击 Smart Manager 捷径图示启动 GIGABYTE Smart Manager 软体，透过 Smart Manager 简易的图示介面，可以轻松校调系统的相关设定。请注意 Smart Manager 使用介面、图示及功能将随您购买的机型、软件版本而有所变更，使用方式请依实际所搭载的 Smart anager 版本操作。

# Smart USB Backup 使用说明 (原 Recovery Image USB)

6

简体中文

## △ 注意

- 为避免储存装置毁损导致原厂的还原映像档遗失，您可以透过此软件来备份原厂的还原映像档
- 如果您想更换新的储存装置，您可以透过此软件将原厂还原映像档备份至 USB 随身碟，安装好新的储存装置后，再将出厂的默认系统倒回新储存装置。
- 使用本软件所制作的还原 USB 随身碟 将系统还原以前，请先做好数据备份，以免数据流失。
- 利用还原 USB 随身碟进行系统还原时，请勿移除或关掉电源。

1



- 若要制作原厂映像档的还原 USB 随身碟，请先插入容量至少有 20GB 的 USB 随身碟 ( 请先将 USB 随身碟里原有的数据备份，避免因下述操作造成 USB 随身碟里的数据遗失 )

2



- 放入驱动程序光盘，执行安装” Smart USB Backup”。( 无内建光驱的机种，请外接 USB 光驱；若光盘内没有软件，请上 <http://www.gigabyte.com> 下载 )。

3



- 安装完成后，执行桌面上的” Smart USB Backup”。

4



- 从清单中选取刚刚插入的 USB 随身碟，然后选择建立还原 USB。

5

- 跳出结束窗口后即完成。
- 若要还原您的系统，请在开机时按 F12，选择用【USB 随身碟开机】，【USB 随身碟】会自动完成还原您的系统。
- 还原时间约需 30 分钟 ( 所需时间会因 USB 随身碟种类而有所不同 )。

# 系统还原使用说明

## 系统还原（修复您的笔记本电脑操作系统）

当操作系统使用上出现不稳定的情况，笔记本电脑原厂出货的储存装置里有一个隐藏磁区，其内容为操作系统的完整备份映射档，可以用来救援系统将储存装置里的操作系统还原到出厂预设值。



### 注意

- 如果储存装置有被更换过或删除该隐藏磁区，还原功能将无法使用，需送维修中心还原。
- 出厂规格为预搭操作系统时才有此还原功能，若是 DOS 销售则不提供此功能。

## 启动系统还原

系统还原功能是笔记本电脑出厂时被预先安装的。该选项可以启动 Windows 故障还原工具，重新安装操作系统为出厂预设值。

以下为简要介绍如何启动还原工具，并开始还原系统。



### 执行还原前请注意

确认笔记本电脑已接上外接电源，还原系统会花费几分钟的时间。

## Windows 10 系统还原说明

1

关机并重新启动笔记本电脑。

2



启动笔记本电脑后，按 F9 按键几秒钟以启动还原工具。

3



选择“Troubleshoot”进入系统还原及高级选项。（您也可以选择“Continue”直接进入 Windows 10 操作系统，备份个人资料与文件后再进行还原。）



系统还原有两种方式可供选择

- **Reset this PC**- 重设计算机设定值  
如果计算机因软件或设定值不佳而不稳定，您可以选择 除或保留个人文件，在重设计算机设定值而不遗失个人文件。
- **GIGABYTE Smart Recovery**  
笔记本电脑的设定值会被还原成出厂默认值。  
注意：将会遗失所有的个人资料与文件。





## Reset this PC - 重置计算机设定值

### ► Keep my files 保留个人档案

选择一个用户帐户后继续。所有应用程序会被删除，设定值会还原成单纯的 OS( 不含 GIGABYTE 应用程序 )，但个人文件会被保留。

### ► Remove everything 删除所有项目

所有应用程序、设定值和个人文件将会被删除。

⇒ **Just remove my files** - 只删除个人文件

只删除个人文件，但保留计算机设定值。

⇒ **Fully clean the drive** - 完整还原

完整还原储存装置至出厂设定值，会花费较长的还原时间。

>【按下“Reset”执行】。



### 注意事项

- 您所有的个人档案与应用程序将会被移除。
- 所有的计算机设定值将会被还原成单纯的 OS ( 不含 GIGABYTE 应用程序 )。



## GIGABYTE Smart Recovery



进入重置系统模式，工具栏会有还原选项，如您确定要系统还原，点选“是”执行。



### 注意

- 一旦选择还原后，所有原本的个人资料与文件将被删除，还原系统及储存装置至出厂默认值。
- 还原窗口开启 进行系统还原，此时请确认接上变压器确保电力充足，请勿关闭电源。



当系统还原完成后，工具栏会有选项，请点选“关机”



■ **Advanced options** 其它或进阶选项  
更多系统还原的进阶设定



**System Restore** 系统还原

选择系统还原的记录时间，将系统还原至该时间点。



**System Image Recovery** 系统备份还原

使用之前备份的系统备份数据还原 Windows 系统。



**Startup Repair** 启动修复程序

修复及解决 Windows 系统问题。



**Command Prompt** 命令提示字符

使用命令字符集执行进阶的疑难解答。



**UEFI Firmware Settings** UEFI BIOS 设定

重新启动，变更 UEFI BIOS 设定值。



**Startup Setting** 启动设定

变更 Windows 启动设定。

# P55 M.2 SSD 散热垫安装流程

10

简体中文

感谢您购买 GIGABYTE P55 系列笔电！若您要对您的 P55 安装 M.2 SSD，我们强烈建议您先阅读过此份说明，以免造成安装失败。另本公司不会负责任何经由个人或或是经销商安装 M.2 SSD 所造成的损坏赔偿，故请您在安装前考虑清楚，谢谢。

1

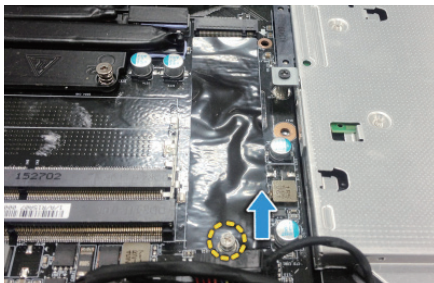

- 打开背盖并解开 M.2 SSD 螺丝。

2



- 取出 P55 随附的散热垫撕下透明贴膜黏贴在 M.2 SSD 上。

3-1



- 黏贴时请注意 M.2 SSD 上的金手指相对位置，并将散热垫贴齐金手指上方，撕下蓝色贴膜。

3-2



4-1



4-2



- 将您的 M.2 SSD 倾斜 45 度角插回至系统中的 M.2 插槽，并锁上螺丝。

 注意

- 在自行安装过程中有任何损坏一概不负责。建议您可将机台带至 GIGABYTE 维修中心，由专业人员为您安装。参考服务据点：  
<http://www.gigabyte.cn/support-downloads/customer-service.aspx>  
有任何问题请咨询技术服务专线：800-820-0926 转接 3

### ■ 保修及客服资讯：

相关保修条款及客服资讯请参考随货所附之保修卡，或参考技嘉技术服务区网站：  
<http://www.gigabyte.cn/support-downloads/technical-support.aspx>

### ■ FAQ：

相关常见问题请参考技嘉常见问题网址：  
<http://www.gigabyte.cn/support-downloads/faq.aspx>

### ■ 完整使用说明书：

详细笔记本电脑使用说明与软体操作说明，请至技嘉 Download-Center 下载电子说明书。  
<http://www.gigabyte.com/support-downloads/download-center.aspx>

## 기가바이트 노트북을 구매 하신 것을 축하 드립니다.

이 설명서는 당신이 새로 구매한 노트북을 처음 세팅 하는데 도움을 줄 것입니다. 마지막 제품의 스펙은 당신의 구매 시점에 따라 다를 수 있습니다. 이는 기가바이트가 사전 서면의 통보 없이 변경할 수 있는 권리를 가지고 있습니다. 보다 더 자세한 정보가 필요 하시면 저의 웹사이트 [www.gigabyte.com](http://www.gigabyte.com). 을 방문 하십시오.

# 기가바이트 노트북 처음으로 사용 하기

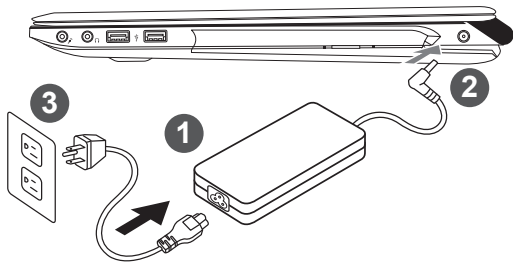

- 1 파워코드를 AC 아답터에 연결 하십시오
- 2 AC 아답터를 노트북 오른쪽의 DC-In 잭에 연결 하십시오
- 3 파워코드를 파워 아울렛에 연결 하십시오



**중요**

- 처음 부팅시에 노트북을 반드시 AC어답터에 연결을 하여 전원을 공급하십시오.
- 노트북 PC의 출력 라벨 을 찾아 어답터의 입출력 전력등급이 부합되는지 확인 하십시오.
- 전원어답터를 통해 전원을 공급시에는 전원소켓이 전원연결 단자에 가깝게 위치하게 하여 사용 중 연결된 다자에서 제거 되지 않도록 유의하십시오.
- 전원 어답터 정보:입력 볼트: 100-240Vac. 입력 주파수: 50-60Hz. 출력 볼트 : 19.5V,9.23A or 19.5V, 10.3A



## 전원 켜기

처음 노트북을 켤시, 운영체제가 모두 셋팅 될 때까지 전원을 끄지 마십시오. 윈도우 셋업이 모두 마치고 전에 오디오는 작동을 하지 않을 수 있습니다.

## 처음으로부터 하기

당신의 환경 설정에 따라, 당신의 노트북의 시작 시 마이크로소프트 윈도우 부트 스크린은 당신의 처음 스크린 일 것 입니다. 스크린상의 자시에 따라 개인정보를 입력하여 윈도우 운영체제 셋업을 마칩시오.

# 기가바이트 노트북 투어

## 정면도

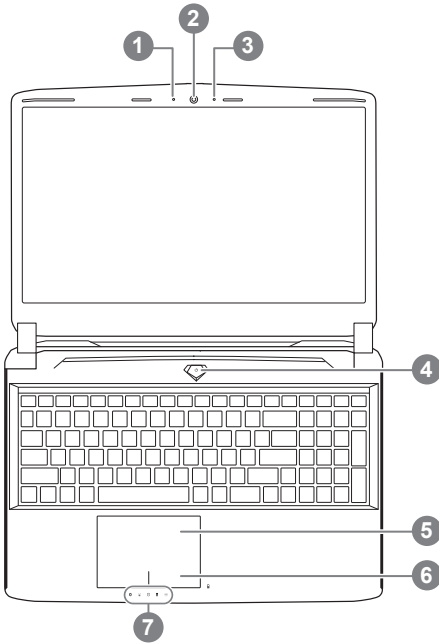

- 1 웹캠 상태 LED 표시등
- 2 웹캠
- 3 마이크로 폰
- 4 전원 버튼
- 5 터치패드
- 6 배터리 표시 버튼 ①
- 7 LED 표시등 ②

① 배터리 잔여량을 확인 하기 위하여 터치패드로른쪽의 버튼을 누르십시오. 터치패드 오른쪽을 클릭하면 배터리 잔여량이 표시 됩니다. 아래 보이는 바와 같이, 배터리 표시등은 노트북이 꺼져 있거나, 대기 혹은 수면 모드시 사용 가능합니다. (배터리 모드)

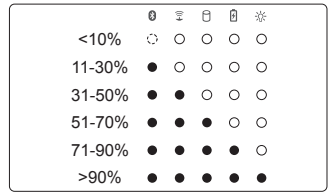

- ② ⑧ 블루투스 LED
- ☰ 무선 랜 상태 표시등
- ☐ HDD 상태 표시등
- Ⓜ 배터리 상태 표시등
- ※ 전원 상태 표시등

## 좌측면도

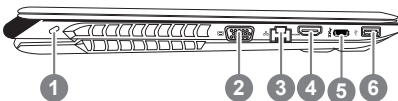

- 1 킹스턴 락 슬롯
- 2 D-sub (VGA) 포트
- 3 에터넷 포트
- 4 HDMI 포트
- 5 USB 3.1
- 6 USB 3.0

## 우측면도

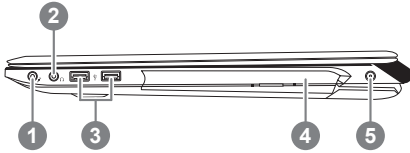

- 1 마이크론 잭
- 2 Headphone Jack
- 3 USB 3.0
- 4 광학 디스크 드라이브
- 5 DC-in 잭

## 바닥면도

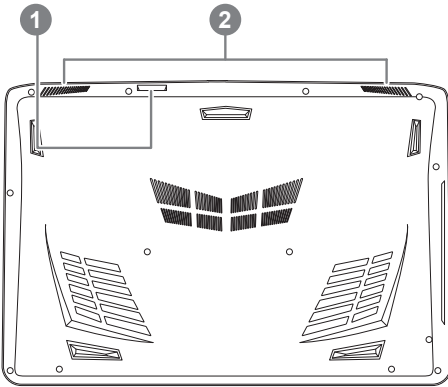

- 1 SD 카드 리더
- 2 스피커



경고 :







어떤 서비스 목적이거나 리튬배터리를 제거하지 마십시오.  
각 지역 지정된 공식 기가바이트 서비스 센터에 연락 하십시오.

- 노트북을 경사가 진 곳이나 진동이 있는 부분에서 설치를 하시거나 장시간 사용을 삼가 하십시오. 이는 제품의 이상이나 문제를 야기 시킬 수 있습니다.
- 태양 직사광선에서의 사용이나 노출 혹은 자동차와 같이 실내 온도가 112°F (45°C)이상의 곳에서는 사용을 피하십시오. 이는 리튬 배터리의 폭발이나 수명 단축을 야기 시킬 수 있습니다.
- 침대, 쿠션, 베개 밑과 같이 통풍이 좋지 않거나 밀폐된 공간에서의 사용을 금하십시오. 또한 바닥이 따뜻한 온돌 등에서의 사용은 노트북의 과열을 초래 하여 기능이상이나 사용상의 문제를 야기 시킬 수 있습니다.



# 핫키

이 컴퓨터는 핫키 또는 조합 키 기능을 채택 하여 화면 밝기 그리고 음성 출력과 같은 대부분의 컴퓨터 제어가 가능합니다. 핫키를 활성화하기 위하여, 조합의 다른 키를 누르기 전에 <Fn> 키를 누르고 계십시오.

핫키	기능	설명
 Fn+~	미디어 컨트롤 핫키	미디어 플레이 컨트롤
 Fn+F1	터치패드 잠금	내부 터치 패드를 켜거나 끕니다.
 Fn+F2	모니터 켜기/끄기	모니터 끄기 (임의의 버튼을 누르거나 터치패드를 사용하여 다시 켤 수 있습니다)
 Fn+F3	스피커 켜기/끄기	스피커를 켜거나 끕니다.
 Fn+F4	슬립모드 전환	컴퓨터를 슬립모드로 진입시킵니다.
 Fn+F5	음량 감소	음량을 줄입니다.
 Fn+F6	음량 증가	음량을 키웁니다.
 Fn+F7	디스플레이 전환	(외장모니터가 있을 경우) 노트북 액정에 화면을 표시할지, 외장모니터에 표시할지, 혹은 함께 표시할지를 선택합니다.
 Fn+F8	밝기 감소	스크린의 밝기를 감소 시킵니다.
 Fn+F9	밝기 증가	스크린의 밝기를 증가 시킵니다.
 Fn+F10	웹캠	웹캠을 켜거나 끕니다.
 Fn+F11	에어플레인 모드 전환	에어플레인 모드 켜기/끄기 *이 기능은 특정 지역에서만 사용 가능합니다.
 Fn+F12	백라이트 토글	키보드 백라이트를 켜거나 끕니다.

## ■ 기가바이트 스마트 매니저

만약 당신이 구매한 기가바이트 노트북이 내장된 운영체제가 포함된 것을 사셨다면, 당신은 바탕화면의 빨리 가기 아이콘을 더블 클릭 함으로서 기가바이트 스마트 매니저를 활성화 할 수 있습니다. 기가바이트 스마트 매니저는 아이콘을 기본적으로 한 제어 인터페이스로서 기본적으로 사용자의 기가바이트 시스템 셋업의 쉬운 접근을 제공하는 기가바이트 독자 유틸리티 입니다. 기가바이트 스마트 매니저의 인터페이스, 아이콘, 유틸리티 그리고 소프트웨어 버전은 당신이 구매한 버전에 따라 다를 수 있습니다. 실제 구매한 버전에 따라 기가바이트 스마트 매니저를 운용하십시오.

# 스마트 USB 백업 안내 (USB 장치를 이용하는 경우)

## 주의

- 장치 손상으로 인해 복구 이미지가 손상된 경우, 이 프로그램을 통해 원래의 복구 이미지를 백업할 수 있습니다.
- 저장장치의 변경없이 USB 디스크를 통해, 원래의 복구이미지를 USB 디스크에 저장하고 복원할 수 있습니다.
- 복원을 진행하기 전에, 중요 데이터의 백업을 반드시 확인하십시오.
- 데이터 복원중에는 절대로 전원을 끄거나 전원에서 분리하지 마십시오.

### 1



- 오리지널 이미지를 저장하기 위해, 20GB 이상의 용량이 확보된 USB 디스크를 연결하십시오.  
(USB 복구 디스크를 작성하는 도중에 USB 디스크 안의 모든 데이터가 삭제되므로 중요한 데이터는 반드시 백업하십시오.)

### 2



- 드라이버 디스크를 ODD 에 삽입하고 "Smart USB Backup" 프로그램을 실행합니다. (ODD 가 없는 모델은 USB 방식의 ODD 를 이용하거나, <http://www.gigabyte.com> 에서 다운로드 하십시오.)

### 3



- "Smart USB Backup" 설치 과정을 완료합니다.

### 4



- 드롭다운 목록에서 USB 디스크를 선택하고 USB 복구 디스크 작성을 시작합니다.

### 5

- USB 복구 디스크 작성이 완료되면 팝업창이 표시됩니다.
- 복구가 필요한 경우, 전원을 켜고 F12 키를 누른 뒤 "boot from recovery USB disk" 항목을 선택하면 시스템이 복원됩니다.
- 복구 과정에는 약 30 분 정도가 소요됩니다.  
(USB 디스크 종류에 따라 소요시간은 달라질 수 있습니다.)

# 복원 가이드

## 시스템복원 (당신의 노트북의 운영체제를 복원)

노트북운영체제에 무엇인가 이상이 생겼을시, 노트북의 숨겨진 파티션에 저장되어 있는 운영체제 복원기능을 통해 노트북을 공장출시상태의 세팅으로 복원을 시킬 수 있습니다.



### 참고

- 만일 저장장치가 켜지거나 교환되거나 파티션이 삭제가 되면 복원선택사항은 더 이상 이용 할 수 없습니다.
- 복원 기능은 운영체제가 기본 내장되어 있는 노트북에서만 가능하며, 운영체제가 저장되어 있지 않은 노트북을 구매 하셨을 경우 복원 기능은 불가능 합니다.

## 시스템 복원장치 실행하기

시스템 복원장치는 노트북이 공장에서 출하하기 전에 이미 설치되어 있으며, 선택메뉴를 통해 윈도우 복원 도구를 실행하여 운영체제를 공장세팅모드로 복원을 시킬 수 있습니다.

아래의 간단한 설명을 통해 어떻게 운영체제 복원을 실행 할 수 있는지 보여줄 것입니다.



### 준비

PC가 전원에 연결된것을 확인 부탁드리며, 몇분이 소요 될 수 있습니다.

# 윈도우 10 복원 가이드

**1** 전원 끈 후 노트북 재 부팅 하기



노트북이 부팅을 시작 할 시 F9 키를 눌러 도구를 실행 하십시오.



“Troubleshoot” 을 선택하여 복원 세팅으로 진입 하십시오. (“Continue” 를 선택하여 복원 시스템에서 나기기를 할 수 있으며, 윈도우 10 파일 데이터 백업으로 진행 할 수 있습니다.)



### 시스템 복원 리셋을 하기 위해서는 2 가지 선택사항이 있습니다.

- Reset this PC - PC 리셋 하기**  
사용자는 파일을 제거 혹은 지우지 않은 상태에서 윈도우를 재 설치 가능합니다.
- GIGABYTE Smart Recovery**  
이 선택사항은 당신의 PC 를 공장출시 규격으로 재 세팅 될것이며, 모든 데이터와 파일은 잃게 될것입니다.  
“PC 리셋하기” 선택



## ■ Reset this PC - “PC 리셋하기” 선택

### ▶ Keep my files 나의 파일 보존하기

계정을 선택하여 계속 하십시오 .

모든 어플은 제거 될 것이며, 운영체제는 초기 값으로 재 설정 됩니다. (기 가바이트 어플 제외), 그러나 개인적인 파일은 보존 될 것입니다.)

### ▶ Remove everything 모든 것을

모든 어플, 세팅, 파일은 제거 되지만 컴퓨터 세팅은 유지 될 것입니다 .

#### ⇨ Just remove my files - 파일만 제거 하기

오직 데이터와 파일만 삭제 될 것입니다 . 그러나 컴퓨터 세팅은 유지 될 것입니다 .

#### ⇨ Fully clean the drive - 드라이브 청소하기

드라이브는 완전히 재 복원 될 것이며, 당신의 노트북은 순수 운영체제 값이 됩니다. (기가바이트 어플 제외)



### 앞으로 진행될

- 모든 개인 데이터와 어플은 삭제 될 것입니다. 당신의 노트북은 완전히 순수 운영체제 값으로 복원될 것입니다.



## ■ GIGABYTE Smart Recovery



복원이 활성화 될 것이며, 화면의 “YES”를 선택하여 시작 합니다.



### 경고

- 복원이 선택이 되면, 복원 후에는 모든 개인 데이터와 파일은 제거 될 것입니다 . 또한 운영체제는 공장도 값으로 재 설정 됩니다. 진행상태를 나타내는 표시 바가 표시 될 것입니다 .



시스템 복원이 완료가 되면, 윈도우 창의 “전원 끄기” 버튼이 나오면 선택을 하십시오 .



## ■ Advanced options 고급 선택사항



### System Restore 시스템복원

당신의 PC 에 저장된 기록 시점을 사용 합니다 .



### System Image Recovery 시스템 이미지 복원

특정 시스테 이미지를 사용하여 윈도우를 복원 합니다 .



### Startup Repair 시작 리페어

윈도우의 로딩 문제시 문제를 해결 합니다 .



### Command Promp 명령 실행

명령 실행을 통해서 고급 트러블 슈팅 을 사용 합니다 .



### UEFI Firmware Settings UEFI BIOS UEFI 펌웨어 세팅

당신의 PC 에서 UEFI 펌웨어을 변경 합니다 .



### Startup Setting 시작 세팅

윈도우의 시작 행동을 변경합니다 .

# P55 에서 M.2 SSD 용 열 패드 설치

P55 시리즈 노트북을 구입해 주셔서 감사합니다! 귀하의 P55에 M.2 SSD를 설치하고자 하는 경우, 설치에 실패하지 않기 위해 우선 이 설명서를 반드시 읽고 진행하십시오. GIGABYTE는 개인이나 판매점이라도 본사 AS 센터 외의 장소에서 진행하는 SSD 손상에 대해 책임을 지지 않습니다. 따라서, 설치하시기 전 반드시 주의 바랍니다!

1

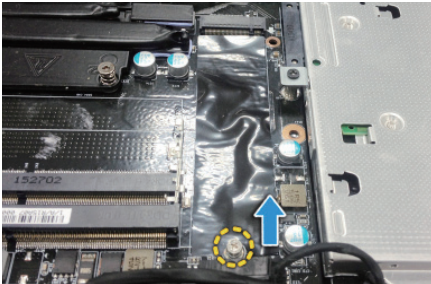

- 뒷면의 커버를 제거 후 M.2.SSD 나서를 풀어 제거 하십시오 .

2



- 써멀 패드의 투명 필름을 제거 하십시오 .

3-1



- 다음 그림과 같이 M.2 SSD 에 써멀 패드를 붙여 넣습니다 클립을 바른위치에 넣고 , 파란색 필름을 제거 하십시오 .

3-2



4-1



4-2

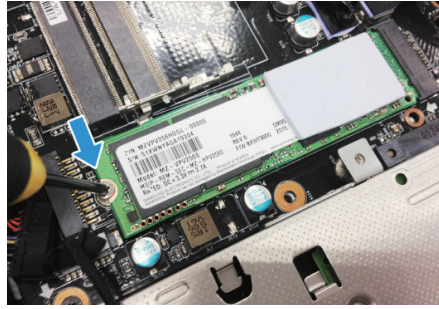

- M.2 슬롯에 SSD 를 삽입하고 나사를 조이십시오 .

#### ⚠ 주의

GIGABYTE 는 설치 중 고객에 의해 발생한 손해에 대해 책임을 지지 않습니다 . 우리는 질문이 있는 경우 , 인증된 GIGABYTE 서비스 센터로 노트북을 보내도록 제안합니다 . 지역 조건에 따라 , 청구될 수 있습니다 .

웹 사이트 : <http://www.gigabyte.com/index.aspx>



### ■ 보증 & 서비스 :

보증, 서비스 그리고 이와 관련된 정보는 워런티 카드를 참조 하시거나 아래의 링크의 기가바이트 사이트를 참고 하십시오 :

<http://www.gigabyte.com/support-downloads/technical-support.aspx>

### ■ 자주 묻는 질문 :

FAQ( 자주 묻는 질문 ) 은 다음의 링크를 참조 하십시오 :

<http://www.gigabyte.com/support-downloads/faq.aspx>

### ■ 사용 설명서 :

상세 노트북 사용 설명 및 소프트웨어 작동 설명은 기가바이트 다운로드 센터에서 다운로드 받을 수 있습니다.

<http://www.gigabyte.com/support-downloads/download-center.aspx>

# Felicitaciones por la compra de la GIGABYTE Notebooks.

Este manual te ayudará a empezar a usar su notebook. Para obtener más información, visite nuestro sitio web en [www.gigabyte.com](http://www.gigabyte.com). Todas las especificaciones están sujetos a la configuración del fabricante en el momento del envío pueden cambiar sin previo aviso.

## Usando GIGABYTE Notebook por primera vez

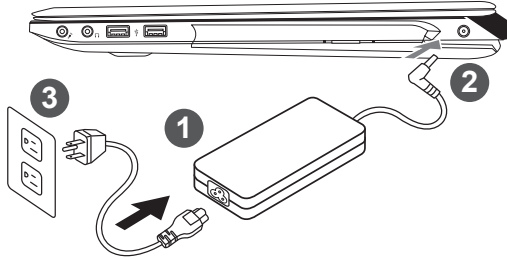

- 1 Conecte el cable de alimentación al adaptador de ca.
- 2 Conecte el adaptador de ca al equipo.
- 3 Conecte el cable de alimentación a una fuente de poder.

### IMPORTANTE

- Asegúrese de que su portátil está conectado a un adaptador de corriente con conexión a tierra antes de encenderlo por primera vez.
- Cuando utilice el portátil con el adaptador de corriente, el enchufe debe de estar cercano y accesible.
- Localice la potencia nominal de su portátil y asegúrese de que coincide con la información de potencia del adaptador de corriente. Algunos modelos de portátil pueden tener varios ratios de potencia basados en los modelos disponibles.
- Información del adaptador de corriente: Voltaje de entrada: 100-240Vac / Frecuencia de entrada: 50-60Hz / Voltaje nominal de salida: 19.5V, 9.23A or 19.5V, 10.3A

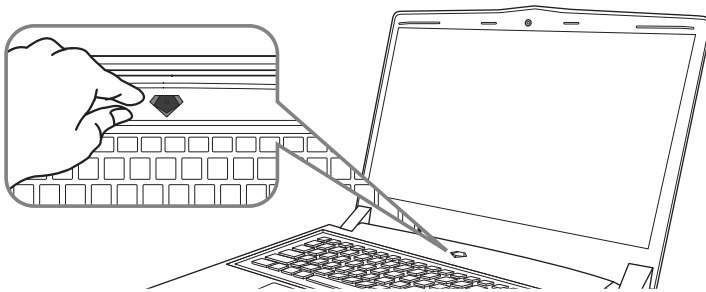

## Conexión de la alimentación

El indicador de encendido se ilumina cuando el equipo está prendido. Después de encender la, por vez primera, no lo apague hasta que el sistema operativo haya sido configurado. Tenga en cuenta que el volumen del audio no funcionará hasta que la instalación de Windows® se haya completado.

## Arrancar la por primera vez

Dependiendo de la configuración, la pantalla de inicio de Microsoft Windows® será la primera pantalla que se pueden ver como inicia el equipo. Siga las instrucciones en pantalla e introduzca su información personal para completar la configuración del sistema operativo Window®.

## Vista Superior

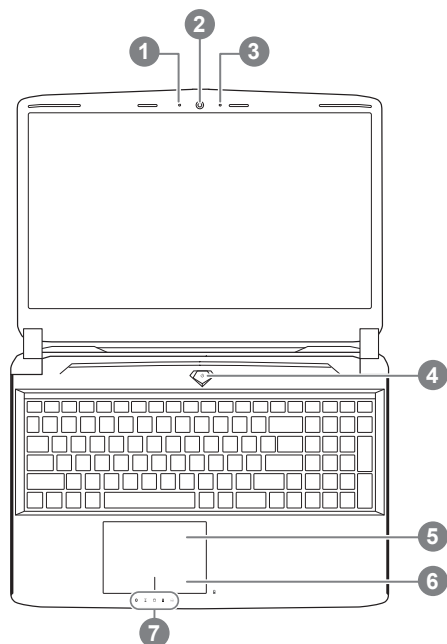

- 1 Indicador de estado LED para Webcam
- 2 Webcam
- 3 Micrófono
- 4 botón de encendido
- 5 Panel Táctil
- 6 Indicador de batería en el botón ❶
- 7 Indicadores LED ❷

❶ Pulse el botón derecho del touchpad para controlar el poder de la batería restante. Haga clic para mostrar el porcentaje de carga restante. Como se muestra a continuación, el indicador de duración de la batería está disponible cuando el portátil está apagado, en stand-by o hibernación.(modo de batería)

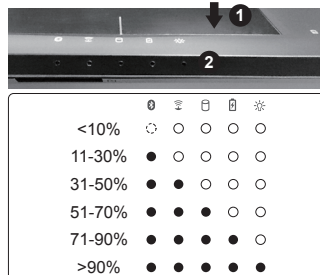

- ❷
  - El Bluetooth LED de estado
  - 📶 El indicador de estado de Wireless LAN
  - 💾 Indicador de estado del Disco duro
  - 🔋 Indicador de estado de la batería
  - ☼ Indicador de Estado

## Vista Izquierda

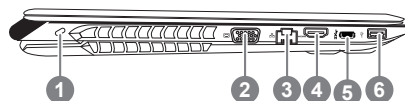

- 1 Ranura de bloqueo Kensington
- 2 D-Sub (VGA)
- 3 Puerto Ethernet
- 4 Puerto HDMI
- 5 USB 3.1
- 6 USB 3.0

## la visión Derecha

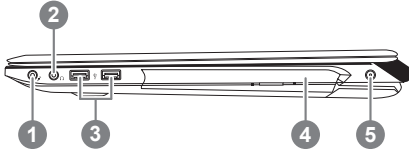

- 1 Micrófono Jack
- 2 Toma de auriculares
- 3 USB 3.0
- 4 Unidad de disco óptico
- 5 La toma de corriente

## Vista de la base

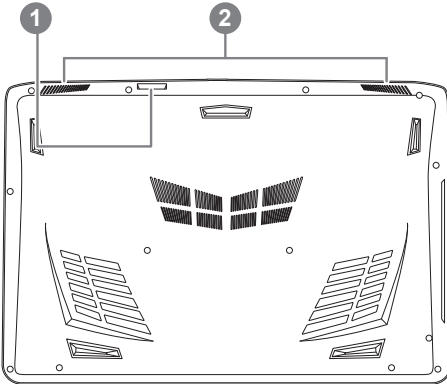

- 1 Lector de tarjetas SD
- 2 Altavoz















### Advertencia:

NO retire la batería de litio incorporada. Para cualquier solicitud de asistencia, por favor comuníquese con su centro de servicio autorizado.

- No instale el equipo portátil en una inclinación o en un lugar propenso a las vibraciones, o evite el uso del PC Portátil por mucho tiempo. Esto aumenta el riesgo de que se produzca un fallo de funcionamiento o daños en el producto.
- No almacene ni utilice PC portátil en luz directa del sol o del lugar donde la temperatura exceda los 112 ° F (45 ° C) como el interior de un vehículo. Existe el peligro de la expansión de la batería de iones de litio y el envejecimiento.
- No use el PC Portátil en un lugar mal ventilado como en la ropa de cama, sobre una almohada o cojín, etc, y no lo utilice en un lugar como la habitación con calefacción por suelo radiante, ya que puede hacer que el equipo se sobrecaliente. Tenga cuidado de que los orificios de ventilación del PC portátil (en el lado o la parte inferior) no están bloqueados sobre todo en estos entornos. Si los orificios de ventilación están bloqueados, puede ser peligroso y provocar que el PC portátil se sobrecaliente.

# Tecla de acceso directo

El ordenador utiliza teclas de acceso rápido o combinaciones de teclas para acceder a la mayoría de los controles de la computadora como el brillo de la pantalla o el volumen. Para activar teclas de acceso directo, pulse y mantenga pulsada la tecla Fn antes de pulsar la tecla de la combinación de teclas rápidas.

Tecla de acceso directo	función	Descripción
 Fn + ~	reproducción	El control de reproducción de medios.
 Fn + F1	touchpad en el botón Alternar	Activa o desactiva la pantalla táctil interna de encendido y apagado.
 Fn + F2	Alternar LCD	LCD apagado (Pulse una tecla o uso TouchPad para activar)
 Fn + F3	Speaker Toggle	Activa el altavoz encendido y apagado.
 Fn + F4	Sleep	Poner el ordenador en modo de suspensión.
 Fn + F5	Bajar volumen	Disminuye el volumen del sonido.
 Fn + F6	Subir volumen	Aumenta el volumen del sonido.
 Fn + F7	MDisplay Toggle	Cambia la salida entre la pantalla y el monitor externo (si está conectado) o ambos.
 Fn + F8	Bajar Brillo	Disminuir el brillo de la pantalla.
 Fn + F9	Subir Brillo	Aumenta el brillo de la pantalla.
 Fn + F10	Webcam	Enciende la cámara web
 Fn + F11	modo de avión	modo de avión ON / OFF *Esta función está disponible solo en ciertas regiones
 Fn + F12	retroiluminación Activar	Encienda la luz de fondo del teclado y se apaga.

## ■ GIGABYTE Smart Manager

Puede activar el Administrador de GIGABYTE Smart doble clic en el icono de acceso directo en el escritorio si la máquina que compró tiene el sistema operativo incorporado. GIGABYTE Smart es una interfaz de control basado en iconos, lo que permite a los usuarios acceder intuitivamente la configuración del sistema común, así GIGABYTE, como empresas de servicios públicos exclusivos. por favor, tener en cuenta que la interfaz del Administrador de GIGABYTE Smart, iconos, utilidades y versiones de software puede variar en función de los modelos adquiridos. por favor, operar GIGABYTE Smart de acuerdo a su versión.

# Guía Smart Backup USB ( Original: Imagen de recuperación USB)

## ⚠ ADVERTENCIA

- Puede realizar la copia de seguridad de recuperación de la imagen original a través de esta aplicación en caso de pérdida por daños en el dispositivo .
- Puede copia de seguridad de imagen original de recuperación en el disco USB y restaurar el sistema si la sustitución del sistema de almacenamiento con el disco USB de recuperación.
- Antes de restaurar el sistema a través del disco del USB de recuperación, asegúrese de que usted ya ha hecho la copia de seguridad de sus datos.
- Por favor, NO apagar o desenchufar el sistema al realizar copias de seguridad a través de la recuperación de disco USB .

6

1



- Por favor, conecte el disco USB que es al menos 20 GB de la capacidad para hacer que la imagen original ( copia de seguridad de los datos en USB primero . Todos los datos serán eliminados durante la creación de la recuperación de disco USB)

2



- Inserte el disco de controladores en la unidad óptica y ejecute la instalación de "Smart USB Backup " (para no - ODD modelo , por favor, utilice dispositivos ODD USB o descarga en <http://www.gigabyte.com>

3



- Ejecute el "Backup USB Smart " después de terminar la instalación.

4



- Seleccione el disco USB de la lista desplegable y comenzar a crear el disco USB de recuperación.

5

- La ventana se abrirá cuando se lleva a cabo la creación de discos de recuperación.
- Por favor, pulse F12 en el arranque del sistema cuando se necesita para restaurar el sistema . Seleccione arranque de la recuperación " será restaurado y el sistema. " disco USB
- El tiempo necesario para la restauración será de alrededor de 30 minutos ( tiempo necesario puede variar según el modelo de disco USB) .

# Recovery Guide

## System Recovery (Restore your laptop operating system)

When something is going wrong with the laptop operating system, the storage of the laptop has a hidden partition containing a full back up image of the operating system that can be used to restore the system to factory default settings.



### Note

- If the storage has been switched or the partition deleted, the recovery option will no longer be available and a recovery service will be needed.
- The recovery function is only available on devices with O/S preinstalled. Devices with DOS do not have the recovery function.

## Launch System Recovery

The system recovery feature is preinstalled before the laptop is shipped from the factory. The option menu allows you to launch the Windows recovery tool to reinstall the operating system to factory default.

The brief introduction below will show you how to start the recovery tool and restore your system.



### All ready to go

Make sure your PC is plugged in. This will take a few minutes.

## Windows 10 Guía de recuperación

1

Apague y reinicie el equipo portátil.

2



Durante el proceso de encendido del equipo portátil, presione sin soltar la tecla F9 para iniciar la herramienta.

3



“Elija “Solucionar problemas” para entrar en la configuración de recuperación. (También puede elegir “Continuar” para salir del sistema de recuperación y continuar con Windows 10 para copia de seguridad de archivos o datos.)”



### Hay dos opciones para la recuperación del sistema:

#### • Restablecer este PC

Puede optar por mantener o quitar los archivos y, a continuación, reinstalar Windows sin perder los archivos.

#### • Utilidad GIGABYTE

Se restaurará la configuración predeterminada de fábrica para la configuración de su PC.

**Precaución: Todos los datos personales y archivos se perderán.**





## ■ Elija “Restablecer este PC”

### ► Conservar mis archivos

Elija una cuenta para continuar. Todas las aplicaciones se quitarán y la configuración volverá a ser el sistema operativo puro (sin la aplicación GIGABYTE), pero los archivos personales se conservarán.

### ► Quitar todo

Todas las aplicaciones, configuraciones y archivos personales se quitarán.

#### ⇒ Eliminar únicamente mis archivos

Solamente se quitarán los datos y archivos personales; la configuración del equipo se conservará.

#### ⇒ Limpiar completamente la unidad

Se restaurará completamente la configuración predeterminada de fábrica de la unidad. Esta acción lleva más tiempo. > [Haga clic en “Restablecer” para ejecutar la función de recuperación.]



### Esto es lo que ocurrirá

- Todas las aplicaciones y archivos personales se quitarán.
- La configuración de su PC volverá a ser el sistema operativo puro (sin la aplicación GIGABYTE).



## ■ Elegir Utilidad GIGABYTE



La recuperación se activará y verá los botones de opción en la ventana. Haga clic en “Sí” para iniciarla.



### Precaución

- “Si selecciona “Recuperación”, los datos y archivos personales se eliminarán después de que el equipo portátil inicie la restauración y se restablecerá la configuración predeterminada de fábrica del sistema operativo.
- Una barra de indicación de progreso se mostrará en la ventana cuando el proceso de recuperación se esté ejecutando. Asegúrese de que el adaptador de CA está enchufado y no apague el equipo portátil.”

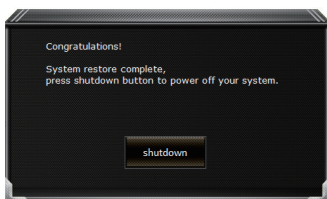

Una vez completada la recuperación del sistema, verá el botón de opción en la ventana. Haga clic en “Apagar”.



## ■ Opciones avanzadas



### **Restauración del sistema**

Utilice un punto de restauración grabado en su PC para restaurar Windows.



### **Recuperación a partir de una imagen del sistema**

Recupere Windows mediante un archivo de imagen del sistema específico.



### **Reparación de inicio**

Solucione problemas que impiden que Windows se cargue.



### **Símbolo del sistema**

Utilice el símbolo del sistema para solución avanzada de problemas.



### **Configuración del firmware UEFI**

Cambie la configuración del firmware UEFI de su PC.



### **Configuración de inicio**

Cambiar comportamiento de inicio de Windows.

# Instalando el Thermal Pad para el M.2 en los P55

Gracias por comprar un portátil de la serie P55! Si quiere instalar un Disco SSD M.2 en su P55, recomendamos encarecidamente que lea estas instrucciones antes para evitar instalaciones fallidas. Nosotros, (GIGABYTE) no nos haremos responsables de ningún tipo de daño ocasionado por una mala instalación.

10

Español

1

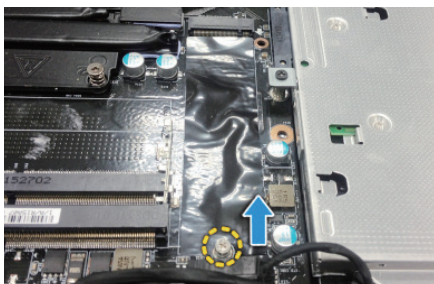

- Abra la cubierta posterior y quite el tornillo para discos SSD M.2

2



- Quite la almohadilla thermal.

3-1



- Póngala en su M.2 siguiendo las instrucciones de la figura. Tenga en cuenta la posición del conector dorado y pegue la almohadilla thermal, alineada con el conector.

3-2



4-1



4-2



- Inserte el SSD en la ranura M.2 y asegúrelo con el tornillo.

**⚠ PRECAUCION**

- GIGABYTE no se hará responsable de ningún tipo de daño ocasionado durante la instalación. Le sugerimos que haga llegar el equipo al centro oficial de GIGABYTE más cercano si tiene alguna duda. Los posibles gastos del servicio dependen de las condiciones locales de cada país. página web: <http://www.gigabyte.com/index.aspx>

### ■ **Warranty & Service:**

Warranty and service and related information please refer to the warranty card or GIGABYTE service website as the below link:

<http://www.gigabyte.com/support-downloads/technical-support.aspx>

### ■ **FAQ:**

FAQ (Frequent Asked Questions) please refer to the below link:

<http://www.gigabyte.com/support-downloads/faq.aspx>

### ■ **Manual de usuario completa:**

Para obtener más guía del usuario y instrucciones de software, consulte el siguiente enlace:

<http://www.gigabyte.com/support-downloads/download-center.aspx>

## Congratulations on your purchase of the GIGABYTE Notebook.

This manual will help you to get started with setting up your notebook. The final product configuration depends on the model at the point of your purchase. GIGABYTE reserves the right to amend without prior notice. For more detailed information, please visit our website at [www.gigabyte.com](http://www.gigabyte.com)

## Using GIGABYTE Notebook for the First Time

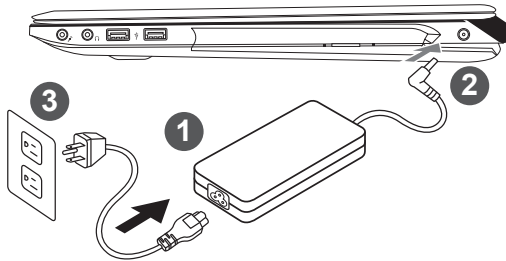

- 1 Connect the power cord to the AC adapter.
- 2 Connect the AC adapter to the DC-in jack on the right side of the notebook.
- 3 Connect the power cord to the power outlet.



### Wichtig!

- Stellen Sie sicher, dass das Notebook mit Ihrem Netzteil verbunden und dieses an der Steckdose angeschlossen ist, wenn Sie das Notebook zum ersten Mal einschalten.
- Wenn Sie Ihr Notebook im Netzteil-Modus betreiben, stellen Sie sicher, dass die Steckdose nahe dem Notebook und leicht zu erreichen ist.
- Lokalisieren Sie das Input/Output-Label auf Ihrem Notebook und stellen Sie sicher, dass die Werte mit denen auf dem Netzteil übereinstimmen. Einige Modelle können basierend auf den Spezifikationen unterschiedliche Werte auführen.
- Informationen zum Netzteil: Eingangsspannung: 100-240 Vac / Eingangsfrequenz: 50-60Hz / Ausgangsspannung: 19.5V, 9.23A or 19.5V, 10.3A

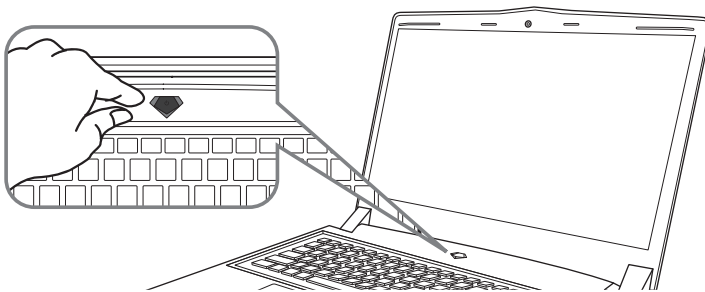

## Switching on the Power

After you turn on the Notebook for the very first time, do not turn it off until the operating system has been configured. Please note that the volume for the audio will not function until Windows® Setup has completed.

## Booting Up the Notebook for the First Time

Depending on your configuration, the Microsoft® Windows® Boot Screen will be the first screen that you will see as the notebook starts up. Follow the on-screen prompts and instructions and enter your personal information to complete the setup of the Windows® Operating System.

# Übersicht Ihres GIGABYTE Notebooks

## Ansicht von oben

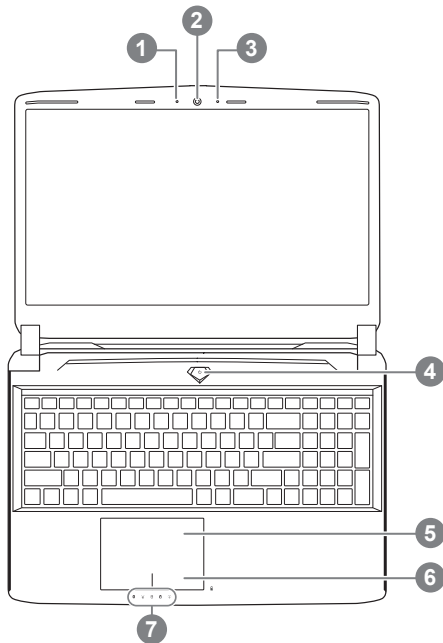

- 1 Webcam Status Anzeiger
- 2 Webcam
- 3 Mikrofon
- 4 Einschaltknopf
- 5 Touchpad
- 6 Akku Ladezustand Anzeiger ❶
- 7 LED Anzeigen ❷

❶ Drücken Sie den rechten Mausbutton des Touchpads um den Akku Ladezustand zu überprüfen. Rechts-Klick um die verbliebene Akku-Kapazität zu prüfen. Wie unten zu sehen ist die Batterieanzeige im Stand-by, Schlafmodus wie auch im ausgeschalteten Zustand verfügbar. (Akku-modus)

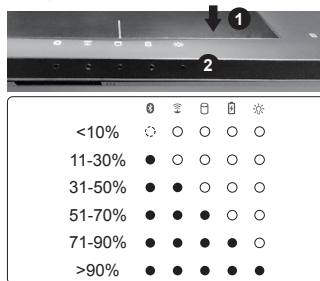

- ❷
- Bluetooth Status Anzeiger
  - wirelose Lan Status Anzeiger
  - HDD Status Anzeiger
  - Akku Status Anzeiger
  - Stromversorgungsstatus

## Ansicht von links

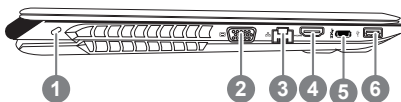

- 1 Kensington Lock
- 2 VGA-Anschluss
- 3 Netzwerkanschluss
- 4 HDMI Port
- 5 USB 3.1
- 6 USB 3.0

## Ansicht von rechts

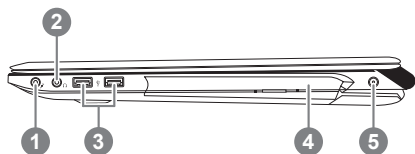

- 1 Mikrofonanschluss
- 2 Kopfhöreranschluss
- 3 USB 3.0
- 4 Optisches Laufwerk
- 5 Stromeingangsbuchse

## Ansicht von unten

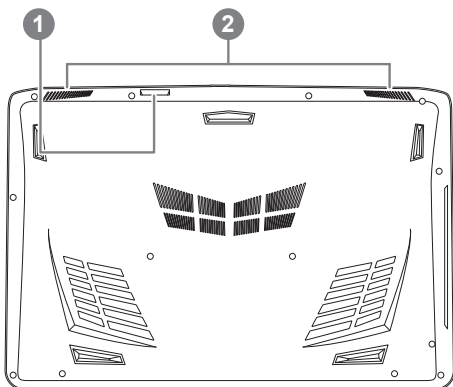

- 1 SD Card Reader
- 2 Lautsprecher



### Achtung:













Entfernen Sie NICHT den eingebauten Lithium-Akku. Für jegliche Wartung kontaktieren Sie Ihre von GIGABYTE autorisierte Service-Stelle.

- Nutzen Sie das Notebook nicht auf schrägen Flächen oder Plätzen die anfällig für Vibrationen sind, oder vermeiden sie dort zumindest die längere Nutzung, da sich sonst die Gefahr der Beschädigung oder von Fehlfunktionen erhöht.
- Setzen Sie ihr Notebook nicht dauerhaft Temperaturen von über 45°, wie z.B. im parkenden Auto, aus, sonst besteht die Gefahr der frühzeitigen Alterung oder Vergrößerung des Lithium-Ionen-Akkus.
- Nutzen Sie Ihr Notebook nicht an schlecht zu belüftenden Oberflächen wie Bettwäsche, Kissen oder Polster und vermeiden Sie die Nutzung auf dem Boden eines Raumes mit Fußbodenheizung, um Überhitzungen vorzubeugen. Achten Sie darauf das die Lüftungseinlässe am Boden und den Seiten ihres Gerätes niemals verdeckt werden. Wenn die Lüftungsöffnungen blöckiert sind führt dies zur Überhitzung ihres Gerätes.



# Schnellasten

Das Notebook hat Hotkeys oder Tastatur Kombinationen für die meisten Funktionen wie Bildschirmhelligkeit und Lautstärke. Um einen Hotkey zu aktivieren halten Sie die <Fn> Taste gedrückt und drücken eine weitere Taste der Hotkey Kombination.

Hotkey	Funktion	Beschreibung
 Fn + ~	Wiedergabe	Medienwiedergabe Play/Pause
 Fn + F1	Touchpad	Schaltet das Touchpad an oder aus.
 Fn + F2	LCD Anzeige	Schaltet das LCD-Display aus (Drücken Sie eine beliebige Taste oder das Touchpad um es wieder einzuschalten)
 Fn + F3	Lautsprecher	Schaltet die Lautsprecher an oder aus.
 Fn + F4	Ruhezustand	Versetzt den Computer in den Ruhezustand
 Fn + F5	Lautstärke vermindern	Vermindert die Lautstärke der Lautsprecher
 Fn + F6	Lautstärke erhöhen	Erhöht die Lautstärke der Lautsprecher
 Fn + F7	Ausgabebildschirm wechseln	Wechselt zwischem dem Notebookbildschirm, Externen Monitorausgang oder der Möglichkeit beide gleichzeitig zu bereiben.
 Fn + F8	Helligkeit verringern	Helligkeits des Bildschirms verringern
 Fn + F9	Helligkeit erhöhen	Helligkeits des Bildschirms erhöhen
 Fn + F10	Webcam	Schaltet die Webcam an oder aus.
 Fn + F11	Flugzeugmodus	Schaltet den Flugzeugmodus AN/AUS *Diese Funktion ist nur in bestimmten Regionen verfügbar
 Fn + F12	Tastaturbeleuchtung	Schaltet die Tastaturbeleuchtung EIN/AUS.

## ■ GIGABYTE Smart Manager

Wenn das Gerät bereits mit einem Betriebssystem ausgeliefert wurde können Sie den GIGABYTE Smart Manager mit einem Doppelklick auf das Desktop Icon starten. Der GIGABYTE Smart Manager hat eine Grafische Benutzeroberfläche die es ermöglicht Einstellungen und exklusive GIGABYTE grafische aufzurufen. Bitte beachten Sie das dies je nach gekauften Modell unterschiedlich sein kann.

# Smart USB Backup Guide (Zuvor: Recovery Image USB)

## ⚠ ACHTUNG

- Sie können mit dieser Anwendung ein Backup Ihres Systems erstellen, um einen Verlust Ihres Systems im Falle von Schäden am Gerät zu vermeiden.
- Sollten Sie die Datenträger ihres Gerätes austauschen, können Sie mit dieser Anwendung ein Backup Ihres Systems erstellen und es nach dem Tausch der Datenträger wiederherstellen
- Bevor Sie Ihr System mit dem USB Backup wiederherstellen möchten, stellen Sie sicher, dass Sie ein Backup Ihrer Dateien erstellt haben
- Bitte schließen Sie Ihr Gerät während des Backups an eine Stromquelle, schalten Sie Ihr System während des Backups nicht aus und entfernen Sie nicht den USB-Datenträger

1



- Bitte schließen Sie Ihren USB-Datenträger mit mindestens 20GB freiem Speicher an Ihrem Gerät an, um ein Image Ihres Systems zu erstellen (Bitte speichern Sie Ihre Daten von Ihrem USB-Datenträger, da diese Daten während des Vorgangs vom USB-Datenträger entfernt werden)

2



- Legen Sie die Driver Disk in ihr optisches Laufwerk und starten Sie die Installation des "Smart USB Backup" (Sollte kein optisches Laufwerk integriert sein, nutzen sie bitte ein externes optisches Laufwerk oder laden sie den Treiber von folgender Seite runter: <http://www.gigabyte.com>)

3



- Starten Sie nach der Installation das "Smart USB Backup"

4



- Wählen Sie vom Drop-Down Menü Ihren USB-Datenträger und starten Sie die Erstellung der Recovery USB Disk

5

- Nach der Erstellung der Recovery Disc erscheint ein neues Fenster
- Drücken Sie während des Startens des Systems die F12 Taste, falls Sie Ihr System wiederherstellen möchten. Wählen Sie "boot from recovery disk". Ihr System wird nun wiederhergestellt
- Die Wiederherstellung dauert etwa 30 Minuten (Die Zeit kann je nach Modell Ihres USB-Datenträgers variieren)

# Anleitung zur Systemwiederherstellung

## Systemwiederherstellung

Das Notebook hat eine versteckte Partition mit einer Kopie des Betriebssystems. Sollten Sie Probleme mit dem Betriebssystem haben, können Sie jederzeit das Gerät auf Werkseinstellungen zurücksetzen.



### Bitte beachten

- Falls die Festplatte gewechselt wurde oder die Partition gelöscht wurde, ist die Wiederherstellungsoption nicht mehr verfügbar und das Gerät muß neu installiert werden.
- Die Wiederherstellungsfunktion ist nur verfügbar wenn bereits bei der Auslieferung ein Betriebssystem installiert ist. Geräte ohne Betriebssystem haben keine Wiederherstellungsfunktion.

## Systemwiederherstellung starten

Die Systemwiederherstellung ist bereits vorinstalliert wenn das Gerät ausgeliefert wird. Im Auswahlm Menü können Sie die Systemwiederherstellung starten und das Gerät auf Werkseinstellungen zurücksetzen.

In der Kurzanleitung finden Sie alle nötigen Informationen um Ihr System wiederherzustellen.



### Achtung

Der PC ist jetzt betriebsbereit. Stellen Sie sicher das Ihr PC am Stromnetz ist. Der Vorgang wird einige Minuten dauern.

## Windows 10 Systemwiederherstellung

**1** Notebook abschalten und neu starten.

**2**



Halten Sie während der Einschaltung des Notebooks zum Starten des Werkzeugs die F9-Taste gedrückt.

**3**



„Wählen Sie zum Aufrufen der Wiederherstellungseinstellungen „Problemlösung“. (Zudem können Sie zum Verlassen des Wiederherstellungssystems und zum Fortfahren von Windows 10 zur Datei- oder Datensicherung „Fortfahren“ wählen.)“



### Es gibt zwei Optionen zur Systemwiederherstellung

#### • Reset this PC

Sie können festlegen, ob Sie die Dateien aufbewahren oder entfernen möchten; installieren Sie Windows dann neu, ohne Ihre Dateien zu verlieren.

#### • GIGABYTE Smart Recovery

Ihre PC-Einstellungen werden auf die werkseitigen Standardeinstellungen rückgesetzt.

**Achtung: Alle persönlichen Daten und Dateien gehen verloren.**



## ■ Diesen PC rücksetzen wählen

### ► Meine Dateien aufbewahren

Wählen Sie ein Konto zum Fortfahren.

Alle Apps werden entfernt und Einstellungen werden auf das reine Betriebssystem (ohne GIGABYTE-App) rückgesetzt; Ihre persönlichen Dateien hingegen werden weiterhin aufbewahrt.

### ► Alles entfernen

Alle Apps, Einstellungen und persönlichen Dateien werden entfernt.

#### ⇒ Nur meine Dateien entfernen

Nur persönliche Daten und Dateien werden entfernt, Computereinstellungen bleiben hingegen erhalten.

#### ⇒ Laufwerk vollständig bereinigen

Das Laufwerk wird vollständig auf die werkseitigen Standardeinstellungen rückgesetzt. Dies erfordert mehr Zeit. > [Klicken Sie zum Ausführen der Wiederherstellungsfunktion auf „Rücksetzen“.]



### Hier folgt, was geschieht

- All Ihre persönlichen Dateien und Apps werden entfernt.
- Ihre PC-Einstellungen werden auf das reine Betriebssystem (ohne GIGABYTE-App) rückgesetzt.



## ■ GIGABYTE Smart Recovery



Die Wiederherstellung wird aktiviert und Sie sehen die Optionsschaltflächen im Fenster. Klicken Sie zum Starten auf „Ja“.



### Achtung

- “Sobald „Wiederherstellung“ ausgewählt ist, werden Ihre persönlichen Daten und Dateien gelöscht, nachdem das Notebook die Wiederherstellung begonnen hat; das Betriebssystem setzt die werkseitigen Standardeinstellungen zurück.
- Eine Fortschrittsleiste erscheint im Fenster, wenn die Wiederherstellung im Gange ist. Bitte stellen Sie sicher, dass das Netzteil angeschlossen ist; schalten Sie das Notebook nicht aus.”



Nach Abschluss der Systemwiederherstellung sehen Sie die Optionsschaltfläche im Fenster; bitte klicken Sie auf „Herunterfahren“.



## ■ Erweiterte Optionen



### **Systemwiederherstellung**

Verwenden Sie einen auf Ihrem PC aufgezeichneten Wiederherstellungspunkt zur Windows-Wiederherstellung.



### **Systemabbildwiederherstellung**

Stellen Sie Windows mit einer spezifischen Systemabbilddatei wieder her.



### **Startvorgang-Reparatur**

Beheben Sie Probleme, die Windows am Laden hindern.



### **Befehlseingabe**

Nutzen Sie die Befehlseingabe für erweiterte Problemlösung.



### **UEFI-Firmware-Einstellungen**

Ändern Sie Einstellungen in der UEFI-Firmware Ihres PCs.



### **Startvorgang-Einstellungen**

Ändern Sie das Startverhalten von Windows.

# Installationsanleitung: Wärmeleitpad für M.2 SSD im GIGABYTE P55

Vielen Dank, dass Sie ein Notebook der GIGABYTE P55-Serie gekauft haben. Möchten Sie eine M.2 SSD in Ihr GIGABYTE P55 einbauen, empfehlen wir Ihnen diese Anleitung genau zu lesen. Sollte beim Einbau der SSD ein Schaden am Gerät oder am Speicher entstehen, kann GIGABYTE dafür nicht verantwortlich gemacht werden. Bitte bedenken Sie dies vor dem Einbau. Vielen Dank!

1

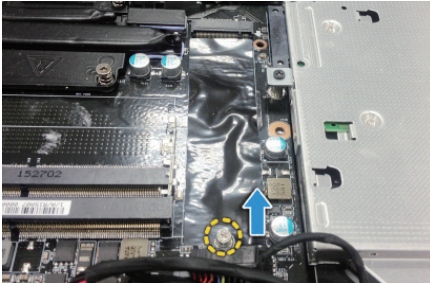

- Öffnen Sie die Wartungsklappe des Notebooks und lösen Sie die Schraube der M.2 SSD

2



- Entfernen Sie die Schutzfolie des Wärmeleitpads

3-1



- Kleben Sie das Pad laut Abbildung auf die M.2 SSD. Entfernen Sie vor dem Aufkleben die blaue Schutzfolie. Achten Sie zusätzlich darauf, dass das Pad nicht die goldenen Pins berührt.

3-2



4-1



4-2

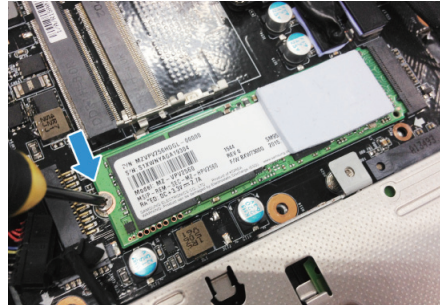

- Stecken Sie die SSD in den M.2 Slot und befestigen Sie die Schrauben.

 **Achtung**

- GIGABYTE übernimmt für Schäden die durch Kunden verursacht wurden keine Verantwortung. Bei Fragen wenden Sie sich bitte an ein autorisiertes GIGABYTE Service Center. Eventuell anfallende Gebühren können je nach Land unterschiedlich sein.  
Website: <http://www.gigabyte.com/index.aspx>



## ■ Garantie und Kundendienst:

Garantie- und Kundendiensthinweise sowie weitere Informationen finden Sie auf der Garantiekarte oder den GIGABYTE-Kundendienstseiten:

<http://www.gigabyte.com/support-downloads/technical-support.aspx>

## ■ Häufig gestellte Fragen:

Häufig gestellte Fragen finden Sie hier:

<http://www.gigabyte.com/support-downloads/faq.aspx>

## ■ Vollständige Anleitungen:

Für mehr Bedien- und Softwareanleitungen nutzen Sie bitte folgenden Link:

<http://www.gigabyte.com/support-downloads/download-center.aspx>

# Félicitations pour l'achat de votre Notebook GIGABYTE

Ce manuel vous aidera à démarrer avec l'installation de votre notebook. La configuration du produit final dépend du modèle acheté. GIGABYTE se réserve tout droit de modifications sans préavis. Pour plus d'informations, merci de consulter notre site internet [www.gigabyte.com](http://www.gigabyte.com)

## Utiliser le Notebook GIGABYTE pour la première fois

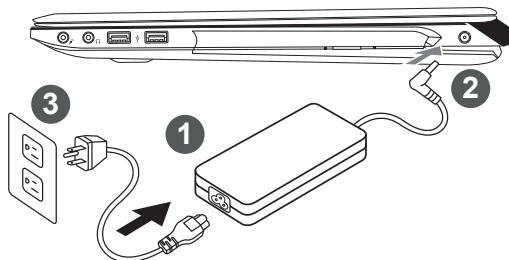

- 1 Branchez le cordon d'alimentation à l'adaptateur AC
- 2 Branchez l'adaptateur AC à la prise "DC-in jack" située sur le coté droit de votre notebook
- 3 Branchez le cordon d'alimentation à une prise secteur

### ⚠ IMPORTANT

- Assurez-vous que votre PC portable est connecté à une prise branchée à la terre avant de l'allumer pour la première fois.
- Lorsque vous utilisez votre ordinateur portable branché à l'adaptateur secteur, la prise de courant doit être à proximité de l'appareil et facilement accessible.
- Repérez l'étiquette signalétique d'entrée / sortie sur votre PC portable et assurez-vous qu'il corresponde aux informations de note d'entrée / sortie de votre adaptateur secteur. Certains modèles de portables, peuvent avoir de multiples prises d'entrées/sorties en fonction des modèles.
- informations de l'adaptateur secteur: Tension d'entrée: 100-240Vac / Fréquence d'entrée: 50-60 Hz / Tension de sortie: 19.5V,9.23A or 19.5V, 10.3A



## Mise sous tension

Après avoir allumé le pour la première fois, n'éteignez pas l'ordinateur avant que le système n'ait été configuré. Notez que le volume audio ne fonctionne pas avant que l'installation Windows® ne soit complètement terminée.

## Premier démarrage du

Selon votre configuration, l'écran de Microsoft® Windows® Boot sera le premier écran qui s'affichera lors du démarrage du netebook. Suivez les instructions et entrez vos informations personnelles pour terminer la configuration de Windows®.

# Visite guidée du Notebook GIGABYTE

## Vue d'en haut

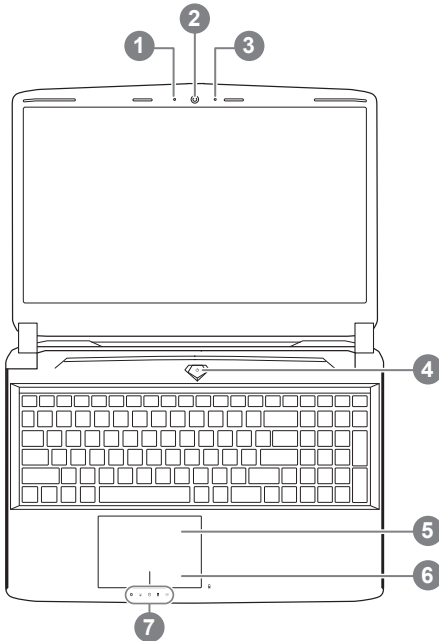

1 état de Webcam LED indicateur

2 Webcam

3 Microphone

4 Haut-parleurs

5 TouchPad

6 Indicateur de batterie ❶

7 Indicateurs LED ❷

❶ Bouton d'alimentation. Un clic sur le bouton droit comm e indiqué ci-dessous, lorsque l'ordinateur est arrêté ou en veille prolongée, vous indiquera le niveau de batterie disponible par tranche de 20%. (Le mode batterie)

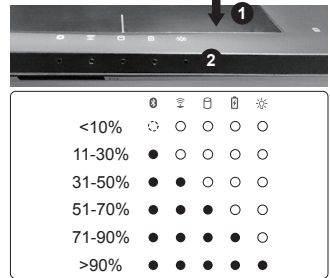

❷ ❸ Bluetooth

❹ Wireless LAN

❺ HDD

❻ Batterie

❼ Indicateur d'état de puissance

## Vue du côté gauche

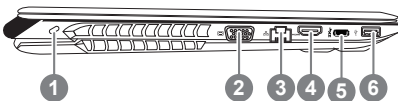

1 Verrou Kensington

2 Port VGA

3 Port Ethernet

4 Port HDMI

5 USB 3.1

6 USB 3.0

## Vue du côté droit

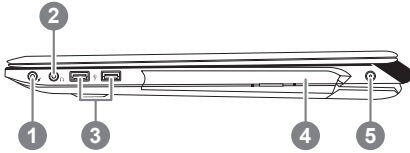

- 1 Prise microphone
- 2 Prise écouteurs / casque audio
- 3 USB 3.0
- 4 Lecteur/graveur optique
- 5 Entrée d'alimentation

## Vue de bas

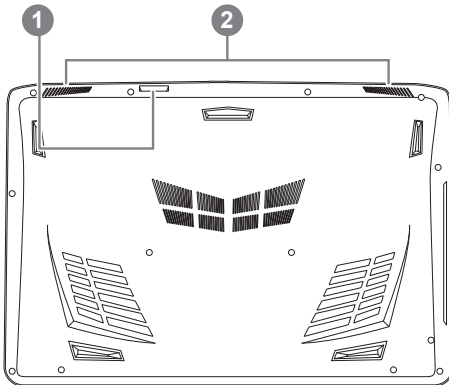

- 1 Lecteur de carte SD
- 2 Haut-parleurs















### Attention:

NE JAMAIS enlever la batterie au Lithium par vous-même. Au besoin, veuillez contacter le Centre de Réparation GIGABYTE le plus proche

- Ne disposez pas votre Portable sur une surface inclinée ou pouvant être soumise à vibrations. En cas de nécessité de telles configurations, réduisez au maximum le temps d'exposition. Une telle mise en place pourrait accroître les risques d'endommagement matériel.
- N'entreposez pas votre Portable dans un environnement où la température ambiante dépasse les 45°C (112°F). N'exposez pas votre Portable à la lumière directe du soleil. Votre batterie Lithium-ion pourrait se dégrader et voir sa durée de vie considérablement réduite.
- Ne placez pas votre Portable en un lieu mal ventilé, comme par exemple sur un lit, coussin, oreiller etc. et ne l'utilisez pas dans une pièce disposant d'un chauffage au sol; votre Portable pourrait surchauffer. Merci de vous assurer avec le plus grand soin que les systèmes de ventilation de votre Portable ne sont pas bloqués ou obstrués lors d'utilisation au coeur de tels environnements. Un système de ventilation obstrué ou ne fonctionnant pas à son plein potentiel pourrait endommager votre Portable par surchauffe.

# Utilisation des touches Fonction

Votre ordinateur dispose de Raccourcis ou combinaisons de touches pour accéder aux principaux contrôles comme l'intensité d'affichage à l'écran ou le contrôle du volume. Pour activer ces fonctions, gardez la touche <Fn> appuyée, en combinaison avec l'autre touche correspondante à la fonction demandée.

Raccourcis	Fonction	Description
 Fn + ~	Lecture/Pause	Touches de contrôle de lecture multimédia
 Fn + F1	TouchPad	Active ou Désactive le pavé tactile (Touchpad)
 Fn + F2	Ecran	Active ou désactive l'affichage à l'écran. (Appuyez sur une touche ou sur le Touchpad pour rallumer)
 Fn + F3	Haut parleurs	Active ou Désactive les haut parleurs
 Fn + F4	Veille	Met l'ordinateur en mode veille
 Fn + F5	Baisser le volume	Baisser le volume
 Fn + F6	Augmenter le volume	Augmenter le volume
 Fn + F7	Affichage	Partage l'affichage entre l'écran du portable et/ou un moniteur externe
 Fn + F8	Diminution la luminosité	Diminue la luminosité de l'écran
 Fn + F9	Augmentation de luminosité	Augmente la luminosité de l'écran
 Fn + F10	Webcam	Active ou Désactive la webcam
 Fn + F11	Mode Avion	Active ou Désactive le mode Avion *La disponibilité de cette fonction dépend des pays
 Fn + F12	Rétroéclairage du clavier	Active ou désactive le rétroéclairage du clavier.

## ■ GIGABYTE Smart Manager

Pour activer le "Smart Manager" double cliquez sur l'icône de raccourci du bureau si la machine que vous avez achetée possède un système d'exploitation intégré. Le "Smart Manager" de GIGABYTE est une interface de contrôle à base d'icônes, permettant aux utilisateurs de accéder intuitivement à la configuration du système commun aussi bien qu'aux services publics exclusifs GIGABYTE. Notez que l'interface "Smart Manager" de GIGABYTE, les icônes, les services publics et les versions des logiciels peuvent varier en fonction des modèles achetés. Utilisez le "Smart Manager" de GIGABYTE en fonction de la version intégrée.

# Smart USB Backup : Guide d'utilisation

(Original: Recovery Image USB)

## ATTENTION

- Vous pouvez sauvegarder l'image de récupération d'origine grâce à cette application en cas de perte par une lésion de l'appareil.
- Vous pouvez sauvegarder l'image de récupération d'origine sur disque ou clé USB et restaurer le système en cas de remplacement du système de stockage avec le disque USB de récupération.
- Avant de restaurer le système à travers le disque USB de récupération, veuillez vous assurer que vous avez fait la sauvegarde de toutes vos données.
- Veuillez NE PAS éteindre ou débrancher le système lors de la sauvegarde sur disque ou clé USB.

1



- Veuillez brancher le disque USB qui est d'au moins 20 Go de capacité pour contenir l'image originale de restauration (Veuillez sauvegarder vos données en premier. Toutes les données seront supprimées lors de la création de la récupération disque USB)

2



- Insérez le disque de pilotes dans votre lecteur et lancez l'installation de "Smart Backup USB" (pour les modèles sans lecteur, veuillez utiliser un lecteur de disques externe sur port USB ou les télécharger via <http://www.gigabyte.fr>)

3



- Exécutez le "Backup Smart USB" après avoir terminé l'installation.

4



- Sélectionnez votre disque/clé USB dans la liste déroulante et de commencez à créer le disque USB de récupération.

5

- Une fenêtre apparaîtra lorsque la création de disque de récupération sera terminée.
- Veuillez appuyer sur F12 au démarrage du système lorsque vous devez restaurer le système. Sélectionnez "boot from recovery USB disk" et le système lancera la restauration.
- Le temps nécessaire pour la restauration sera d'environ 30 minutes (Le temps nécessaire peut varier selon le modèle du disque/clé USB).

# Guide du système de restauration

## Système de restauration (restaurer le système d'exploitation de votre Portable)

Quand quelque chose ne va pas avec le système d'exploitation de votre portable, le système de stockage de l'ordinateur a une partition cachée contenant une image de sauvegarde complète du système d'exploitation qui peut être utilisée pour restaurer le système en revenant aux paramètres d'usine par défaut.



### Note

- Si le système de stockage a été changé ou la partition supprimée, l'option de récupération ne sera plus disponible et un service de récupération complet sera nécessaire.
- La fonction de récupération est disponible uniquement sur les appareils avec un système d'exploitation préinstallé. Les appareils livrés sous DOS ne disposent pas de la fonction de restauration.

## Utiliser System Recovery

La fonction de restauration du système d'exploitation est installée en nos usines. Le menu d'options au démarrage vous permet de lancer l'outil de restauration de Windows pour réinstaller le système d'exploitation avec les réglages d'usine par défaut.

La brève introduction ci-dessous va vous montrer comment démarrer l'outil de restauration et comment restaurer votre système.



### Tout est prêt pour commencer

Assurez-vous que votre PC est branché au courant. Patientez ensuite quelques minutes.

## Guide de restauration du système Windows 10

1

Eteignez et redémarrez votre ordinateur.

2



Pendant que l'ordinateur redémarre, appuyez et maintenez la touche F9 appuyée pour lancer l'utilitaire.

3



Choisissez "Troubleshoot" (Résoudre) pour entrer dans les paramètres de restauration. (Vous pouvez également choisir "Continue" (continuer) pour sortir du système de restauration et continuer de démarrer votre portable sous Windows 10 pour sauvegarder vos données et fichiers personnels.



### Il y a deux options de restauration :

- **Reset this PC**

Vous pouvez choisir de conserver ou d'effacer vos fichiers et ensuite de réinstaller Windows sans perdre vos données.

- **GIGABYTE Smart Recovery**

Vos paramètres seront restaurés à l'origine, comme lorsque le PC est sorti d'usine.





## ■ Choix “Reset this PC”

### ► Keep my files : Conserver mes fichiers

Choisissez un compte avant de continuer. Toutes les applications seront effacées, et les paramètres reviendront à l'origine (sans les applications GIGABYTE), mais vos fichiers personnels seront conservés.

### ► Remove everything : Tout effacer

Tous les paramètres, applications et fichiers personnels seront effacés.

#### ⇒ Just remove my files : Effacer seulement mes fichiers

Seules les données personnelles seront effacées, mais les paramètres de l'ordinateur seront conservés.

#### ⇒ Fully clean the drive : Nettoyer complètement le disque

Le disque sera complètement restauré d'usine avec tous les paramètres d'origine. Cela prend plus de temps. [Cliquez sur “Reset” pour exécuter la restauration]



### Voici ce qui va se passer

- Tous vos fichiers personnels et applications seront supprimés.
- Les paramètres de votre PC seront restaurés à l'origine du système d'exploitation (sans les applications GIGABYTE)



## ■ GIGABYTE Smart Recovery



La restauration sera activée et vous verrez les boutons des différentes options. Cliquez sur “Yes” (oui) pour commencer.



### Attention

- Une fois la restauration lancée, vos données personnelles et fichiers seront effacés dès que l'ordinateur commence la restauration, et le système d'exploitation sera restauré avec les paramètres d'usine.
- Une barre de progression indiquera la progression du processus de restauration dans la fenêtre. Vérifiez que l'adaptateur secteur est bien branché et n'éteignez pas l'ordinateur.



Après la fin de la restauration cliquez sur le bouton “Shutdown” (Eteindre) pour éteindre votre ordinateur.



## ■ Options avancées



### **System Restore : Restauration du système**

Utilisez un point de restauration enregistré au préalable sur votre ordinateur pour restaurer votre système.



### **System Image Recovery : Restauration à partir d'une image système.**

Restaurer Windows en utilisant une image spécifique du système.



### **Startup Repair : Réparation du système de démarrage**

Résoudre les problèmes qui empêchent le chargement de Windows.



### **Command Prompt : Invite de commandes**

Utiliser l'invite de commande pour un dépannage avancé.



### **UEFI Firmware Settings : Paramétrage du BIOS UEFI**

Changer les paramètres du BIOS UEFI



### **Startup Settings : Paramètres de démarrage**

Changer le comportement de Windows au démarrage.

# Procédure d'installation d'un patch thermique sur un SSD M.2 pour P55

Nous vous remercions d'avoir acheté un portable GIGABYTE P55. Si vous souhaitez installer un SSD M.2 sur votre P55, nous vous conseillons de suivre attentivement les instructions qui suivent afin d'éviter tout problème par la suite. GIGABYTE se dégage de toute responsabilité concernant l'installation d'un SSD, par qui que ce soit en dehors du centre de réparation agréé GIGABYTE.

1

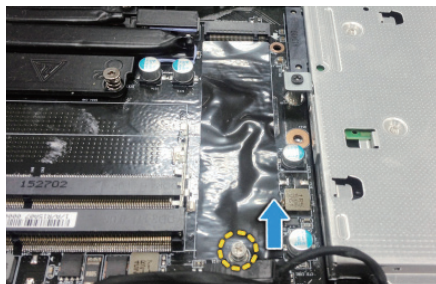

- Ouvrez le panneau arrière du PC et libérez la vis sur l'emplacement du SSD M.2

2

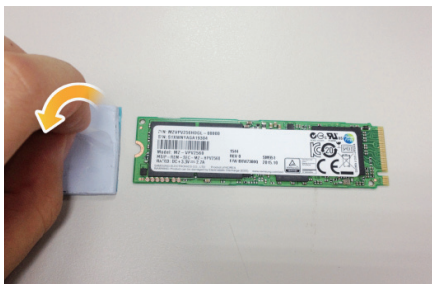

- Prenez le patch thermique et otez la protection du patch thermique avant de le coller sur le SSD.

3-1



- Collez le sur le SSD M.2 comme indiqué sur l'image ci-dessus. Veillez à laisser libre les connecteurs dorés en alignant le patch thermique comme indiqué sur l'image 3-1. Enlevez l'éventuel film bleu du patch thermique.

3-2



4-1



4-2



- Insérez le SSD dans l'emplacement M.2 et vissez la vis pour le fixer.

**⚠ ATTENTION**

- GIGABYTE ne sera en aucun cas responsable de tout dommage éventuel causé par l'utilisateur pendant l'installation. Nous vous suggérons d'envoyer votre PC portable à notre centre de réparation ou vers un revendeur si vous avez le moindre doute sur la manipulation. Cela peut engendrer un coût supplémentaire qui dépendra des conditions qu'ils vous proposeront.

### ■ Garantie & service:

Concernant la garantie, les services et informations complémentaires, merci de consulter votre carte de garantie ou au site internet GIGABYTE ci-dessous:

<http://www.gigabyte.fr/support-downloads/support-downloads.aspx>

### ■ Foire Aux Questions:

FAQ (Questions fréquentes) - Référez-vous au lien suivant :

<http://www.gigabyte.fr/support-downloads/faq.aspx>

### ■ Manuel de l'utilisateur complet :

Pour plus d'informations sur l'utilisation de ce produit, veuillez télécharger guides et manuels ici :

<http://www.gigabyte.fr/support-downloads/download-center.aspx>

## Complimenti per l'acquisto del Notebook GIGABYTE.

Questo manuale vi aiuterà a iniziare la configurazione del notebook. La configurazione del prodotto finale dipende dal modello al punto di acquisto. GIGABYTE si riserva il diritto di modificare senza preavviso. Per informazioni più dettagliate, si prega di visitare il nostro sito web all'indirizzo [www.gigabyte.com](http://www.gigabyte.com).

## Utilizzando GIGABYTE notebook per la prima volta

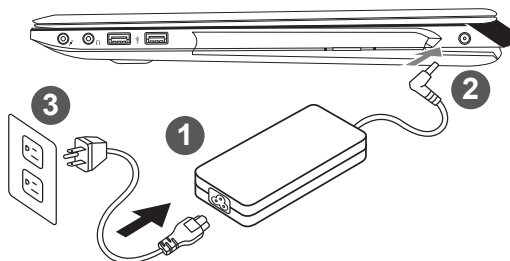

- 1 Collega il cavo di alimentazione nel AC adattatore.
- 2 Collega l'adattatore AC al jack DC-in sul lato destro del notebook.
- 3 Collega il cavo di alimentazione alla presa di corrente.

### IMPORTANTE!

- Assicurarsi che il notebook è collegato ad adattatore di alimentazione con messa a terra prima di accenderlo per la prima volta.
- Quando si utilizza il PC Notebook in modalità di adattatore di alimentazione, la presa deve essere vicina all'unità e facilmente accessibile.
- Localizzare la letichetta di input / output sul Notebook e assicurarsi che corrisponda alle informazioni Valutazione input/output del sul alimentatore. Alcuni modelli di Notebook possono avere più correnti di uscita valutazione basata sul SKU disponibili.
- Informazioni del Adattatore di alimentazione:

Tensione di Input: 100-240Vac, - Frequenza di Input: 50-60Hz, - Tensione Valutazione di output: 19.5V, 9.23A or 19.5V, 10.3A



## Accensione del Alimentazione

Dopo aver acceso il Notebook per la prima volta, non spegnerlo fino quando il sistema operativo è stato configurato. Si prega di notare che il volume dell'audio non funzionerà fino quando l'installazione di Windows® è stata completata.

## L'avviamento del Notebook per la prima volta

Secondo alla configurazione, la schermata di avvio di Microsoft® Windows® sarà la prima schermata che si vedrà come il notebook si avvia. Segue le istruzioni e le istruzioni su schermo e inserire le informazioni personali per completare la configurazione del sistema operativo Windows®.

# Un giro nell tuo GIGABYTE Notebook

## Vista dall'alto

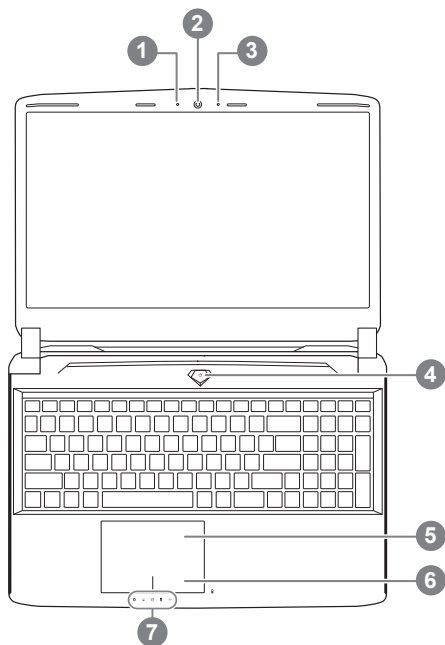

- 1 Indicatore LED di stato di Webcam
- 2 Webcam
- 3 Microfono
- 4 Pulsante di accensione
- 5 TouchPad
- 6 Indicatore di pulsante di batteria ❶
- 7 Indicatori LED ❷

❶ Premere il tasto destro del touchpad per controllare la carica residua della batteria. Tasto destro del mouse per visualizzare la percentuale di carica residua. Come mostrato di seguito, l'indicatore della durata della batteria è disponibile quando il portatile è spento, in stand-by o ibernazione. (Modalità batteria)

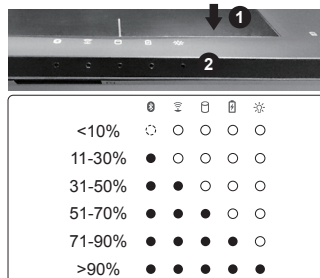

- ❷
- ❷ LED Stato di bluetooth
  - 📶 LED Stato di internet
  - 💾 LED Stato di HDD
  - 🔋 LED Stato di batteria
  - ⚡ LED Stato di potenza

## Vista Sinistra

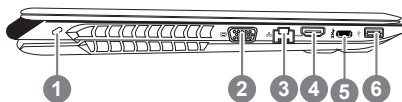

- 1 Porta di Kensington Lock
- 2 Porta D-sub (VGA)
- 3 Porta di Internet
- 4 Porta di HDMI
- 5 Porta di USB
- 6 USB 3.0

## Vista Destra

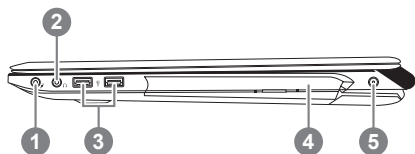

- 1 Ingresso del Microfono
- 2 Uscita della cuffie
- 3 Porta di USB
- 4 Unità Optical
- 5 Porta di DC-in

## Vista dal base

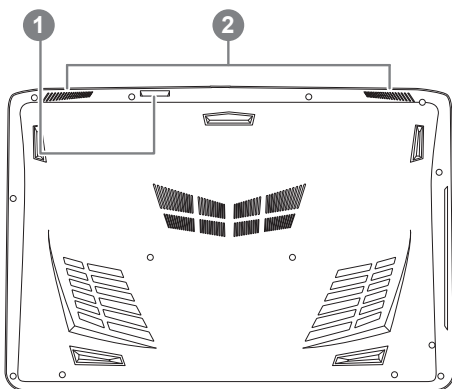

- 1 Letto di carta SD
- 2 Altoparlanti



### Warning:













NON rimuovere la batteria al litio incorporata. Per eventuali esigenze di servizio, si prega di contattare il centro di assistenza autorizzato locale dal GIGABYTE.

- Non installare il Notebook PC su un taglio o un luogo soggetto a vibrazioni, o evitare di utilizzare il Notebook in quella posizione per un lungo periodo. Questo aumenta il rischio che si verifichino problemi di funzionamento o danni al prodotto.
- Non conservare e utilizzare Notebook in luce diretta del sole o la posizione in cui la temperatura supera i 112 ° F (45 ° C), come ad esempio all'interno di un veicolo. C'è il pericolo di espansione della batteria agli ioni di litio e l'invecchiamento.
- Non utilizzare il Notebook in un luogo scarsamente ventilato come sulla biancheria, su un cuscino, ecc., e non utilizzarlo in un luogo come la camera con riscaldamento a pavimento come potrebbe causare il surriscaldamento del computer. Fare attenzione che le aperture di Notebook (sul lato o sul fondo) non siano bloccate soprattutto in questi ambienti. Se le prese d'aria sono bloccate, può essere pericoloso e causare surriscaldamento del Notebook..



## Tasti di scelta rapida

Il computer utilizza tasti di scelta rapida o combinazioni di tasti per accedere alla maggior parte dei controlli, quali la luminosità dello schermo e uscita volume. Per attivare tasti di scelta rapida, tenere premuto il tasto <Fn> e premere l'altro tasto della combinazione.

Tasti di scelta rapida	Funzione	Descrizione
 Fn + ~	Riproduzione	Controllo di riproduzione multimediale.
 Fn + F1	Touchpad Toggle	Svolta il touchpad interno ON/OFF
 Fn + F2	LCD Toggle	Spegne LCD (Premere un tasto o usare TouchPad per attivare)
 Fn + F3	Altoparlanti Toggle	Svolta il altoparlanti ON/OFF
 Fn + F4	Modo dormire toggle	Mette il computer in modalità sospensione
 Fn + F5	Abbassa volume	Diminui il volume
 Fn + F6	Aumenta volume	Aumenta il volume
 Fn + F7	Display Toggle	Scambia is display output tra lo schermo, monitor esterno( se collegato) ed entrambi
 Fn + F8	Riduci luminosità	Diminui la luminosità dello schermo
 Fn + F9	Aumenta luminosità	Aumenta la luminosità dello schermo
 Fn + F10	Webcam	Svolta la webcam interna ON / OFF
 Fn + F11	Toggle Modalità aereo	Attiva la modalità aereo ON / OFF Questa funzione è disponibile solo in alcune regione
 Fn + F12	Toggle Retroilluminazione della tastiera	Svolta la retroilluminazione della tastiera ON/ OFF

# Applicazione software di GIGABYTE

Si noti che l'interfaccia, le icone e le caratteristiche del software possono variare a seconda della versione installata e il vostro modello di computer portatile.

## ■ Amministratore intelligente di GIGABYTE

È possibile attivare amministratore intelligente di GIGABYTE facendo doppio clic sull'icona del collegamento sul desktop, se la macchina acquistata c'è l'operazione del sistema operativo integrato. Amministratore intelligente di GIGABYTE è un'interfaccia di controllo basata su icone, che consente agli utenti di accedere intenzionalmente configurazione del sistema comune, così come GIGABYTE utilità esclusivi. Si prega di notare che l'interfaccia della amministratore intelligente di GIGABYTE, le icone, i servizi e le versioni del software possono variare in base ai modelli acquistati. Si prega di operare amministratore intelligente di GIGABYTE a seconda della effettiva versione incorporato.

# Guida intelligente di USB Backup (originale: Recupero immagine di USB)

## Avvertimento

- Puoi fare il backup del recupero de la immagine attraverso questa applicazione, in caso di perdita da danni del dispositivo.
- Puoi fare il backup del recupero de la immagine su disco USB e ripristinare il sistema di qualsiasi sistema di storage.
- Prima di ripristinare il sistema attraverso il disco di ripristino USB, assicurarsi di avere già fatto il backup dei dati.
- Si prega di NON spegnere o scollegare il sistema durante l'esecuzione di backup tramite disco di ripristino USB.

1



- Si prega di inserire il disco USB che è almeno 20 GB di capacità per rendere l'immagine originale (backup dei dati in USB. Tutti i dati saranno eliminate durante la creazione di recupero disco USB)

2



- Inseri il disco driver nell'unità ottica ed esegui l'installazione di "Smart USB Backup "(per nessuno - modello di ODD, si prega di utilizzare dispositivi ODD USB o scarisca da <http://www.gigabyte.com>

3



- Esegui il "Backup USB Smart" dopo aver terminato l'installazione.

4



- Seleziona il disco USB dall'elenco a discesa e inizia a creare il disco di ripristino USB.

5

- La finestra si aprirà quando la creazione di disco di ripristino è fatto.
- Si prega di premere F12 sulla avviare il sistema quando è necessario ripristinare il sistema. Selezionare "Boot dal disco di ripristino USB" e il sistema verrà ripristinato.
- Il tempo necessario per il ripristino sarà di circa 30 minuti (tempo necessario può variare a seconda del modello del disco USB).

# Guida di Recupero

## Ripristino di sistema (ripristinare il sistema operativo portatile):

Quando qualcosa che non va con il sistema operativo del computer portatile, la conservazione del portatile ha una partizione nascosta che contiene un backup di immagine completa del sistema operativo che può essere utilizzato per ripristinare il sistema alle impostazioni di fabbrica.



### Nota:

- Se allo stoccaggio è stato attivato o eliminare la partizione, l'opzione di ripristino non sarà più disponibile e verrà richiesta un servizio di recupero.
- La funzione di recupero è disponibile solo su dispositivi con sistema operativo pre installato. I dispositivi con DOS non hanno la funzione di recupero.

## Avviare Ripristino di sistema:

La funzione di ripristino del sistema è preinstallato prima che il portatile è spedito dalla fabbrica. Il menu delle opzioni consente di avviare lo strumento di recupero di Windows per reinstallare il sistema operativo di default di fabbrica.

La breve introduzione di seguito vi mostrerà come avviare lo strumento di recupero e ripristinare il sistema.



### Tutto pronto ad andare

Assicurarsi che il PC sia collegato. Questo richiederà alcuni minuti.

## Guida di Recupero per Windows 10

1

Spegnere e riavviare il computer portatile.

2



Durante il portatile accende sul processo, premere e tenere premuto F9 chiave per avviare lo strumento.

3



Scegliere "Risoluzione dei problemi" per immettere le impostazioni di recupero. (Inoltre è possibile scegliere "Continua" per uscire sistema di recupero e continuare a Windows 10 per i file o backup dei dati.)



### Ci sono due opzioni per il ripristino del sistema

- **Aggiorna il tuo PC**

È possibile aggiornare il vostro computer portatile per migliorare la stabilità del sistema senza perdere i file

- **Recupero Intelligente di GIGABYTE**

Le impostazioni del PC verrà ripristinato alle impostazioni di fabbrica.

**Attenzione: Tutti i dati personali ei file verranno persi.**



## ■ Scegliere “Reset questo PC”

### ► **Mantenere i miei file**

Scegliere un account per continuare. Tutte le applicazioni saranno rimosse, e le impostazioni sosterrà a puro O / S (senza GIGABYTE app), ma i file personali saranno conservati.

### ► **Rimuovere tutto**

Tutte le applicazioni, impostazioni e file personali saranno rimossi.

### ⇒ **Rimuovi i miei file**

Solo i dati personali ed i file saranno rimossi, ma le impostazioni del computer verranno conservati.

### ⇒ **Pulisci completamente il disco**

L'unità sarà completamente ripristinato le impostazioni predefinite. Ci vuole più tempo. > [Clicca su “Reset” per eseguire la funzione di recupero.]



### **Ecco cosa accadrà**

- Tutti i file e applicazioni personali saranno rimossi.
- Le impostazioni del PC verranno ripristinate al puro O / S (senza GIGABYTE app).



## ■ Recupero Inteligente di GIGABYTE



La ripresa sarà attivato e si vedrà la pulsanti di opzione sulla finestra. Clicca su “Si” per avviarlo .



### **Attenzione:**

- Una volta selezionato il “Recupero”, i dati personali e file saranno cancellati dopo che il portatile si avvia il ripristino, e il sistema operativo verrà riportato a impostazioni di fabbrica.
- Un indicatore di avanzamento mostra sulla finestra quando il processo di recupero è in funzione. Si prega di accertarsi che l'adattatore CA sia collegato e non spegnere il portatile.

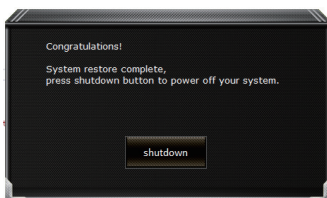

Dopo il ripristino del sistema è completato, si vedrà il pulsante di opzione sulla finestra, cliccate sul “Fermare”.



## ■ Opzioni avanzate



### Ripristino del sistema

Utilizza un punto di ripristino registrati sul PC per ripristinare Windows.



### Recupero di immagine del sistema

Recupera Windows utilizzando un file di immagine del sistema specifico



### Recupero Automatico

Risolve i problemi che impediscono il caricamento di Windows.



### Comando Immediato

Utilizza il comando immediato per la risoluzione avanzata dei problemi.



### Impostazioni del firmware UEFI

Modifica le impostazioni di firmware UEFI del PC.



### Impostazione di avvio

Cambia il comportamento di avvio di Windows.

# Installazione del Pad termico per M.2 SSD su P55

Se si desidera installare M.2 SSD sul P55, si consiglia vivamente che si dovrebbe leggere questo istruzioni prima per non installtton sicuro. Noi (GIGABYTE) Non saremo responsabili per qualsiasi danno da installazione di SSD sia da singoli o fornitore. Quindi, per favore riconsiderare esso Prima dell'installazione, grazie!

1

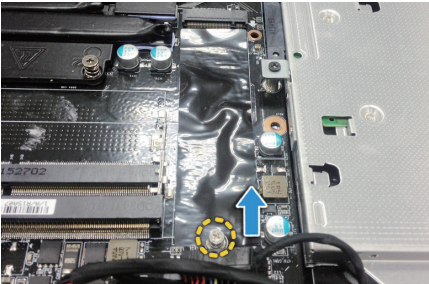

- Apri il coperchio posteriore e allenta la vite per M.2 SSD

2



- Strappa la pellicola trasparente sul pad termico

3-1



- Per incollare il pad termico sulla parte superiore del M.2 SSD e allineato con il chip sul lato destro,poi strappare la pellicola blu.

3-2



4-1



4-2



- Inseri il SSD per slot di M.2 e stringere la vite

 **ATTENZIONE**

- GIGABYTE non assume qualche responsabilità per eventuali danni cliente indotto durante l'installazione. Vi consigliamo di inviare il notebook a un centro di assistenza autorizzato GIGABYTE se qualsiasi domanda.  
Fare eventuali oneri dipende dalle condizioni locali.  
Sito web: <http://www.gigabyte.com/index.aspx>



### ■ **Garanzia e assistenza:**

Garanzia e assistenza e le relative informazioni si rimanda al sito web del servizio di garanzia o GIGABYTE come sul link qui sotto:

<http://www.gigabyte.com/support-downloads/technical-support.aspx>

### ■ **FAQ:**

FAQ(Domande frequenti)consultare il seguente link:

<http://www.gigabyte.com/support-downloads/faq.aspx>

### ■ **Manuale d'uso completo:**

Per più manuale d'uso e di istruzioni del software, fare riferimento al link sottostante:

<http://www.gigabyte.com/support-downloads/download-center.aspx>

# Selamat atas pembelian notebook GIGABYTE Anda.

Panduan ini akan membantu Anda untuk memulai dengan memandu menyiapkan notebook anda. konfigurasi produk tergantung pada model dari pembelian Anda. GIGABYTE berhak untuk mengubah tanpa pemberitahuan sebelumnya. Untuk informasi lebih lanjut, silahkan kunjungi website kami di [www.gigabyte.com](http://www.gigabyte.com)

## Menggunakan GIGABYTE Notebook untuk Pertama Kalinya

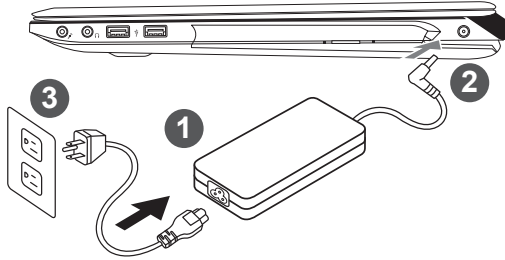

- 1 Sambungkan kabel daya ke adaptor AC.
- 2 Sambungkan adaptor AC ke DC-in jack di sisi kanan notebook.
- 3 Sambungkan kabel daya ke stopkontak.

### PENTING!

- Pastikan bahwa PC Notebook Anda terhubung ke adaptor listrik ground sebelum dinyalakan untuk pertama kalinya.
- Bila menggunakan PC Notebook Anda pada mode power adapter, stopkontak harus dekat dengan unit dan mudah diakses.
- Menemukan label rating input / output pada PC Notebook Anda dan memastikan bahwa itu cocok dengan rating Informasi input / output pada adaptor daya. Beberapa model PC Notebook mungkin memiliki beberapa arus output berdasarkan SKU yang tersedia.
- Informasi daya adaptor:

Tegangan input: 100-240Vac,- Frekuensi Input: 50-60Hz,- Tegangan output Nilai: 19.5V,9.23A or 19.5V, 10.3A

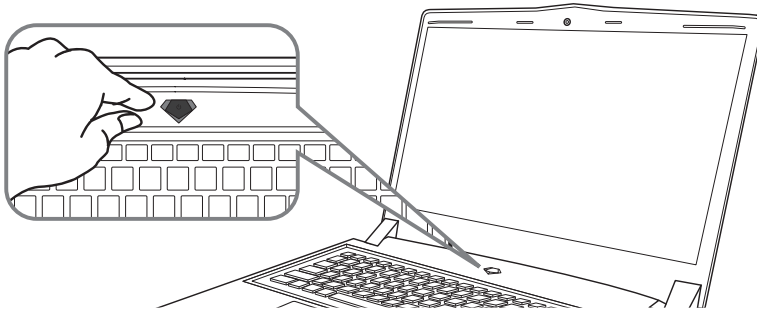

## Beralih pada Power/Daya

Setelah Anda mengaktifkan Notebook untuk pertama kalinya, jangan mematikannya sampai sistem operasi telah dikonfigurasi. Harap dicatat bahwa volume audio tidak akan berfungsi sampai Windows® Pengaturan telah selesai.

## Boot Up Notebook untuk Pertama Kalinya

Tergantung pada konfigurasi Anda, Microsoft® Windows® Boot Screen akan menjadi layar pertama yang akan Anda lihat setelah notebook dinyalakan. Ikuti petunjuk pada layar dan instruksi dan masukkan informasi pribadi Anda untuk menyelesaikan pengaturan Sistem Operasi Windows.

# Peedoman Notebok GIGABYTE anda

## Tampilan Atas

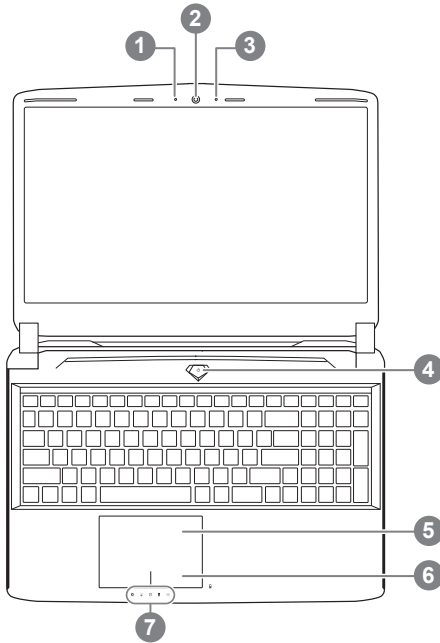

- 1 Status indikasi LED kamera web
- 2 kamera web
- 3 mikrofon
- 4 tombol daya
- 5 Panel Sentuh
- 6 Tombol indikasi baterai ①
- 7 Indikator LED ②

① Tekan tombol kanan dari panel sentuh dan cek sisa daya baterai. Klik-Kanan untuk menunjukkan sisa persentasi dari daya baterai. Seperti yang tertera di bawah, indikasi baterai akan tersedia jika laptop itu sendiri keadaan tutup, di posisi siaga atau hibernasi. (Mode baterai)

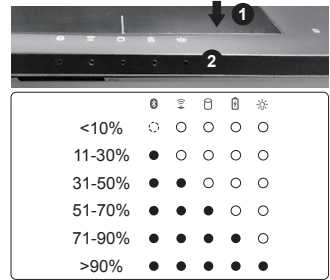

- ② ② Status indikasi Bluetooth
- ② Status indikasi LED Nirkabel
- ② LED status HDD
- ② LED status Baterai
- ② LED status daya

## Tampilan Kiri

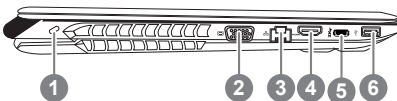

- 1 Lubang kunci Kensington
- 2 Lubang Port D-sub (VGA)
- 3 Lubang Ethernet
- 4 Lubang HDMI
- 5 Lubang USB

## Tampilan Kanan

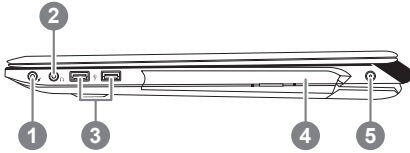

- 1 Jack Mikrofon
- 2 USB Port
- 3 USB Port
- 4 Penggerak cakram optik
- 5 DC-in Jack

## Tampilan bawah

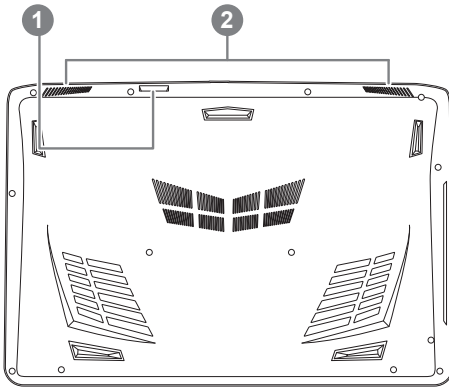

- 1 Pembaca Kartu SD
- 2 Pengeras suara















### PERINGATAN:

JANGAN keluarkan baterai lithium built-in. Untuk setiap kebutuhan pelayanan, silakan hubungi servis center GIGABYTE setempat.

- Jangan menginstal PC Notebook pada keadaan miring atau tempat rawan getaran, atau hindari menggunakan PC Notebook di lokasi demikian. Ini akan meningkatkan risiko kerusakan atau kerusakan yang akan terjadi pada produk anda.
- Jangan pernah menyimpan dan menggunakan PC Notebook menghadap sinar matahari langsung atau lokasi di mana suhu melebihi 112 ° F (45 ° C) seperti di dalam kendaraan. Dimana akan terjadi bahaya pemekaran dan penuaan pada baterai.
- Jangan menggunakan PC Notebook di lokasi ventilasi yang buruk seperti di tempat tidur, di atas bantal atau alas bantal, dll, dan jangan menggunakannya dalam lokasi seperti kamar dengan pemanas lantai karena dapat menyebabkan komputer kepanasan. Untuk merawat notebook anda, ventilasi PC Notebook (di samping atau bawah) jangan diblokir terutama di daerah tersebut. Jika ventilasi diblokir, mungkin berbahaya dan menyebabkan PC Notebook terlalu panas.

# Tombol Cepat

komputer mempergunakan tombol cepat atau kombinasi tombol untuk mengakses sebagian besar kontrol komputer seperti kecerahan layar dan volume. Untuk mengaktifkannya, tekan dan tahan tombol <Fn> sebelum menekan tombol lainnya.

Hot Keys	Fungsi	Deskripsi
 Fn + ~	Pemutaran	Kontrol pemutaran media
 Fn + F1	Pengalihan Touchpad	Mengatur touchpad ON/OFF
 Fn + F2	Pengalihan LCD	Mematikan LCD OFF (Tekan tombol untuk menyalakannya ON)
 Fn + F3	Pengalihan Speaker	Mengalihkan Speaker ON/OFF
 Fn + F4	Pengaturan "Sleep Mode"	Mengatur Komputer "Sleep Mode"
 Fn + F5	Memperkecil Suara	Memperkecil Volume Suara
 Fn + F6	Memperbesar Suara	Meningkatkan Volume Suara
 Fn + F7	Pengalihan Layar	Beralih tampilan pada layar, Monitor eksternal (jika terhubung) pada kedua-duanya.
 Fn + F8	Menurunkan cahaya layar	Menurunkan tingkat cahaya layar
 Fn + F9	Meningkatkan cahaya layar	Meningkatakan tingkat cahaya layar
 Fn + F10	Kamera Web	Pengalihan web kamera ON/OFF
 Fn + F11	Pengalihan mode penerbangan	Pengalihan ke Mode Penerbangan ON/OFF *Fungsi ini hanya tersedia/tergantung pada regional
 Fn + F12	Pengaturan Lampu papan ketik	Pengalihan Lampu papan ketik ON/OFF

# Aplikasi GIGABYTE software

## ■ GIGABYTE Smart Manager

Anda dapat mengaktifkan GIGABYTE Smart Manager dengan mengklik dua kali yang terdapat pada ikon shortcut pada desktop anda jika mesin yang Anda beli memiliki operasi sistem bawaan ini. GIGABYTE Smart Manager adalah berbasis ikon, yang memungkinkan pengguna untuk mudah akses ke dalam sistem pengaturan umum serta GIGABYTE utilitas. Harap dicatat bahwa GIGABYTE Smart Manager, ikon, utilitas dan versi software dapat bervariasi berdasarkan model yang dibeli. Silakan mengoperasikan GIGABYTE Smart Manager sesuai dengan yang bersi built-in yang terbaru

# Panduan Cerdas Pencadangan via USB (Original: Pemulihan Gambar USB)

## ⚠ PERINGATAN

- Anda dapat membuat cadangan untuk pemulihan image asli melalui aplikasi ini, apabila ada kehilangan oleh kerusakan perangkat.
- Anda dapat backup image recovery asli via USB disk dan mengembalikan sistem dari setiap sistem penyimpanan pengganti dengan pemulihan USB.
- Sebelum Anda mengembalikan sistem melalui recovery disk USB, pastikan bahwa Anda sudah membuat cadangan data Anda.
- Harap JANGAN mematikan atau cabut USB tersebut pada saat melakukan backup melalui recovery disk USB.

1



- Silakan pasang di disk USB yang setidaknya 20 GB untuk membuat "original image"(Backup data di USB pertama. Semua data akan dihilangkan selama proses pemulihan USB disk)

2



- Masukkan disk ke ODD dan munculkan pencadangan SMART USB\* (untuk model yang tidak mempunyai ODD, silahkan gunakan perangkat USB ODD atau unggah dari <http://www.gigabyte.com>

3



- Jalankan "Pencadangan Smart USB" setelah instalasi telah selesai.

4



- Pilih USB disk Anda dari daftar drop-down dan mulai untuk membuat pemulihan disk USB.

5

- pada jendela akan muncul setelah disk pemulihan telah dilaksanakan.
- Silahkan tekan F12 pada waktu anda ingin memilih "Boot dari USB pemulihan disk" dan sistem akan di pulihkan.
- Waktu yang dibutuhkan untuk pemulihansekitar 30 menit (waktu yang dibutuhkan dapat bervariasi tergantung model USB) .

# Panduan pemulihan

## Sistem Pemulihan (Restore sistem operasi laptop Anda):

Bila terjadi kesalahan dengan sistem operasi laptop, penyimpanan laptop memiliki partisi tersembunyi yang berisi penuh cadangan image dari sistem operasi yang dapat digunakan untuk memulihkan sistem ke pengaturan pabrikannya.



### Catatan

- Jika penyimpanan telah beralih atau partisi terhapus, opsi pemulihan tidak akan lagi tersedia dan layanan pemulihan akan dibutuhkan.
- Fungsi pemulihan hanya tersedia pada perangkat dengan OS pra instal. Perangkat dengan DOS tidak memiliki fungsi pemulihan.

## Meluncurkan Sistem Pemulihan:

Fitur pemulihan sistem sudah diinstal sebelum laptop tersebut dikirim dari pabrik. Menu pilihan memungkinkan Anda untuk meluncurkan alat pemulihan Windows untuk menginstal ulang sistem operasi ke pabrikannya.

Pengenalan singkat di bawah ini akan menunjukkan cara untuk memulai alat pemulihan dan mengembalikan sistem Anda.



### Persiapan

Pastikan PC anda terpasang. Ini akan di butuhkan beberapa menit.

## Pemulihan Gratis Windows 10

1

Matikan dan restart laptop.

2



Selama proses peralihan sistem di laptop anda, silahkan tekan terus key F9 untuk maluncurkan sistemnya.

3



Pilih Masalah untuk memasukkan pengaturan pemulihan. (Anda juga dapat memilih Lanjutkan untuk keluar sistem pemulihan dan melanjutkannya ke Windows 10 untuk file atau data cadangan.



### Dua cara yang dapat dilakukan untuk pemulihan sistem

- **Meperbarui PC ini**  
Anda dapat memperbarui sistem stabilitas laptop anda tanpa menghilangkan data-data yang ada.
- **Atur ulang PC anda**  
Jika Anda ingin menghapus semua file Anda, Anda dapat mengatur ulang PC Anda sepenuhnya.  
**Perhatian: Semua data pribadi dan file akan hilang.**





#### ■ Pilih “Refresh PC Anda”

##### ► Keep my files

Pilih akun untuk lanjut. Semua Apps akan dihapus, dan pengaturan akan kembali ke OS sebelumnya (tanpa aplikasi GIGABYTE), tetapi file pribadi Anda akan tersimpan.

##### ► menghapus semuanya

Semua aplikasi, pengaturan dan file pribadi akan dihapus.

##### ⇒ Hanya menghapus file saya

Hanya data pribadi dan file akan dihapus, namun pengaturan komputer akan disimpan.

##### ⇒ Sepenuhnya menghapus drive

drive akan sepenuhnya dikembalikan ke pengaturan pabrikannya. Dibutuhkan waktu yang panjang. > [Klik “Reset” untuk menjalankan fungsi pemulihan.]



#### Berikut adalah apa yang akan terjadi

- Semua file pribadi Anda dan aplikasi akan dihapus.
- Pengaturan PC Anda akan dikembalikan ke pengaturan pabrikannya.



#### ■ GIGABYTE Smart Recovery



pemulihan akan diaktifkan dan Anda akan melihat tombol pilihan pada jendela. Klik “Ya” untuk memulainya.



#### Perhatian:

- Setelah “Recovery” dipilih, data pribadi Anda dan file akan dihapus setelah laptop mulai memulihkan, dan sistem operasi akan diatur ulang ke pengaturan pabrikannya.
- Sebuah bar indikator progress akan ditampilkan di jendela ketika proses pemulihan berjalan. Pastikan adaptor AC terpasang dan tidak mematikan laptop.



Setelah pemulihan sistem selesai, Anda akan melihat tombol pilihan pada jendela, silakan klik “Matikan”.



## ■ Pilihan lanjutan



### **pemulihan sistem**

Gunakan restore point yang tersimpan pada PC Anda untuk memulihkan Windows



### **Pemulihan Sistem Image**

Recover Windows menggunakan sistem file image.



### **Perbaiki secara otomatis**

solusi untuk sistem Windows dari loading.



### **Gommand Prompt**

Menggunakan Command Prompt untuk pemecahan masalah yang lebih lanjut.



### **Pengaturan UEFI Firmware**

Merubah pengaturan PC's UEFI firmware.



### **Pengaturan startup**

Mengubah pemualain Windows sesuai dengan yang dikehendakinya.

# Memasang Pad Thermal untuk M.2 SSD di P55

Jika Anda ingin menginstal M.2 SSD pada P55 Anda, kami sangat menyarankan bahwa Anda harus membaca instruksi ini terlebih dahulu, agar tidak gagal pada waktu instalasi. Kami (GIGABYTE) tidak akan bertanggung jawab atas kerusakan dari instalasi SSD baik oleh individu atau vendor. Jadi silakan PERTIMBANGKAN terlebih dahulu sebelum instalasi, terima kasih!

1

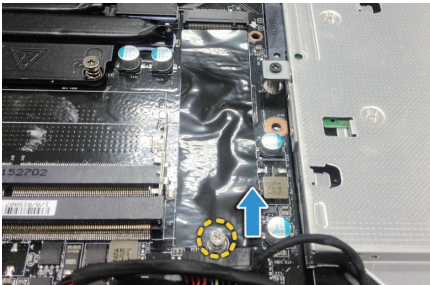

- Buka penutup belakang dan lepas sekrup M.2 SSD

2

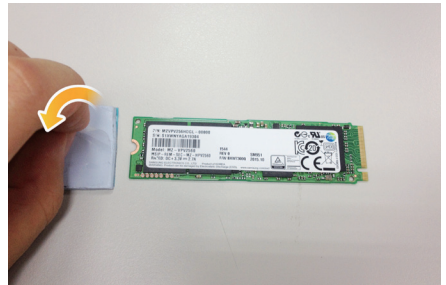

- Merobek film transparan yang terdapat pada thermal pad

3-1



3-2



- Untuk menempelkan thermal pad pada bagian atas M.2 SSD dan harus selaras dengan chip di sisi kanan, kemudian merobek film biru.

4-1



4-2



- Masukkan SSD ke slot M.2 dan kencangkan dengan sekrup

**⚠ PERHATIAN**

- GIGABYTE tidak akan bertanggung jawab untuk setiap pelanggan yang kerusakannya disebabkan oleh pelanggan sendiri, selama atau diwaktu pemasangannya. Kami menyarankan untuk mengirim notebook Anda ke pusat layanan GIGABYTE resmi, jika ada pertanyaan. Biaya tergantung pada setiap daerah itu masing-masing.
- Website: <http://www.gigabyte.com/index.aspx>

### ■ **Garansi & Servis :**

Sehubungan dengan informasi garansi dan servis, silahkan merujuk ke website servis GIGABYTE yang tertera di link berikut :

<http://www.gigabyte.com/support-downloads/technical-support.aspx>

### ■ **Pertanyaan Umum :**

FAQ (Pertanyaan Umum) silahkan lihat di link berikut ini:

<http://www.gigabyte.com/support-downloads/faq.aspx>

### ■ **Buku Panduan**

Untuk panduan dan petunjuk perangkat lunak yang lebih lanjut, silahkan klik di link berikut://[www.gigabyte.com/support-downloads/download-center.aspx](http://www.gigabyte.com/support-downloads/download-center.aspx)

## Gratulujeme k nákupu GIGABYTE notebooku.

Tento manuál Vám pomůže s prvním nastavením Vašeho notebooku. Konfigurace notebooku se liší podle zakoupeného notebooku. GIGABYTE si vyhrazuje právo na změnu bez předchozího upozornění. Pro více informací, prosíme, navštivte naše stránky [www.gigabyte.com](http://www.gigabyte.com)

## První zapnutí notebooku GIGABYTE

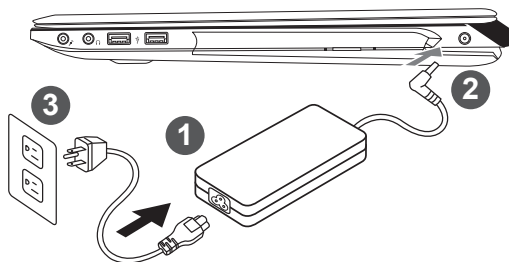

- 1 Připojte napájecí kabel do AC adaptéru
- 2 Zapojte AC adapter do zařízení - DC-in vstup na pravé straně zařízení.
- 3 Zapojte napájecí kabel do sítě.

### ⚠ DŮLEŽITÉ!

- Ujistěte se, že notebook je připojený k uzemněnému adaptéru než ho zapnete.
- Během používání Vašeho notebooku při zapojeném adaptéru mějte dobře přístupnou elektrickou zásuvku.
- Najděte štítek se vstupními / výstupními hodnotami napětí na vašem notebooku, a ujistěte se, že odpovídá informacím na napájecího adaptéru.
- Informace na napájecím adaptéru: - Vstupní napětí: 100-240Vac, - Vstupní frekvence: 50-60Hz, - Výstupní napětí: 19.5V



## Zapnutí zařízení

Po první zapnutí vašeho notebooku, prosíme, nevypínejte zařízení dokud nebude ooperační systém nakonfigurován. Upozorňujeme, že během konfigurace systému není možné nastavovat zvuk.

## První nastavení Vašeho notebooku

Podle zakoupené konfigurace Vašeho zařízení, může být zobrazena možnost Microsoft® Windows® Boot Screen, kde uvidíte konfigurování systému. Následujte prosím zobrazené instrukce a vyplňte požadované informace k dokončení konfigurace systému.

# Průvodce Vašeho notebooku GIGABYTE

## Vrchní pohled

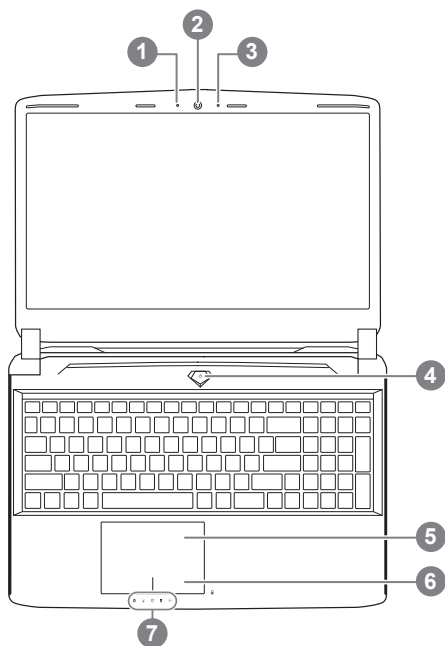

- 1 LED indikátor webkamery
- 2 Webkamera
- 3 Mikrofon
- 4 Zapínací tlačítko
- 5 TouchPad
- 6 Indikátor baterie ①
- 7 LED indikátory ②

- ① "Kliknutím pravým tlačítkem zobrazíte stav baterie v procentech. Zobrazení je možné pouze při vypnutém zařízení, v režimu spánku nebo v hibernaci."

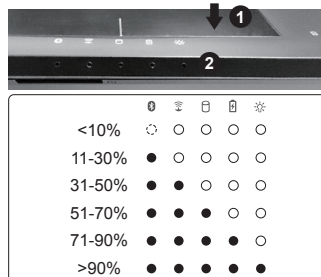

- ②
- Bluetooth indikátor
  - WiFi indikátor
  - HDD indikátor
  - Indikátor baterie
  - Indikátor zapnutí

## Levý pohled

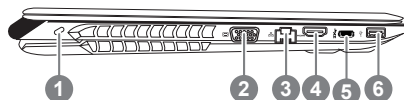

- 1 Zámek Kensington
- 2 D-sub (VGA) Port
- 3 Ethernet Port
- 4 HDMI Port
- 5 USB 3.1
- 6 USB 3.0

## Pravý pohled

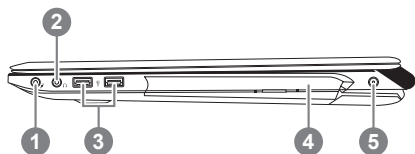

- 1 Vstup pro mikrofon
- 2 Vstup pro sluchátka
- 3 USB 3.0
- 4 Optická mechanika
- 5 Napájecí konektor

## Spodní pohled

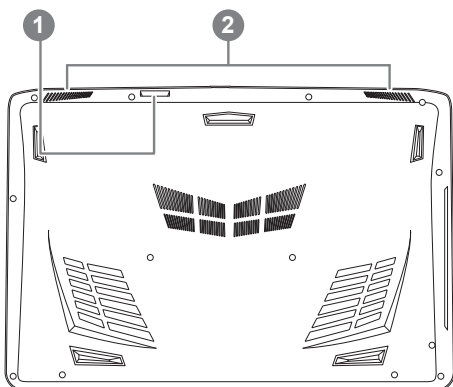

- 1 Čtečka SD Karet
- 2 Reproduktory















### Upozornění:

Nikdy nevyndávejte integrovanou lithiovou baterii. Pro jakékékoliv servisní potřeby prosíme kontaktujte autorizovaný servis GIGABYTE.



# Funkční klávesy - hotkeys

Zařízení lze ovládat pomocí funkčních kláves nebo klávesových zkratk a kombinací jako je ovládání jasu obrazovky či hlasitosti. K jejich aktivaci je nutné stisknout a držet tlačítko <Fn> dříve než stisknete funkční klávesu.

Funkční klávesa	Funkce	Popis
 Fn + ~	Playback	Ovládání přehraavače
 Fn + F1	Ovládání touchpadu	Vypnutí/zapnutí touchpadu
 Fn + F2	Ovládání obrazovky	Vypnutí/zapnutí LCD panelu
 Fn + F3	Ztlumení zvuku	Vypnutí/zapnutí reproduktorů
 Fn + F4	Režim spánku	Přezne zařízení do režimu spánku
 Fn + F5	Snížení hlasitosti	Snížení hlasitosti
 Fn + F6	Zvýšení hlasitosti	Zvýšení hlasitosti
 Fn + F7	Přepnutí displaye	přepínání mezi LCD displaye a externím monitorem (pokud je připojen)
 Fn + F8	Snížení jasu	Sníží jas obrazovky
 Fn + F9	Zvýšení jasu	Zvýší jas obrazovky
 Fn + F10	Režim spánku	Přezne zařízení do režimu spánku
 Fn + F11	Režim letadla	Zapnutí/vypnutí režimu letadla
 Fn + F12	Podsvícení klávesnice	Zapnutí/vypnutí podsvícení klávesnice

## ■ GIGABYTE Smart Manager

GIGABYTE Smart Manager můžete aktivovat dvojitým klikem na ikonu na ploše vašeho zařízení, které mělo již operační systém předinstalovaný.

GIGABYTE Smart Manager je jednoduché grafické rozhraní, které umožní uživatelům velmi intuitivně nastavit zařízení podle svých potřeb pomocí ikon.

Verze aplikace závisí na zakoupené konfiguraci zařízení.

# Průvodce Smart USB Backup (Původně: Recovery Image USB)

## ⚠ Varování

- Můžete využít této zálohy pomocí této aplikace v případě ztráty nebo poškození zařízení
- Můžete si nástroj pro obnovu systému přehrát na USB disk a obnovit si takto jakékoli zařízení.
- Před použitím tohoto nástroje se prosím ujistěte, že máte zlohovány všechny data.
- prosíme, nevypínejte zařízení během průběhu vytváření systémů obnovy na USB.

1



- Připojte prosím USB s kapacitou minimálně 20GB volného prostoru pro vytvoření systému pro obnovu zařízení. Všechna data na USB budou před vytvoření smazány.

2



- Vložte disk do optické mechaniky a spusťte instalaci "Smart USB Backup". Pokud nemáte optickou mechaniku, můžete si stáhnout aplikaci na <http://www.gigabyte.com>

3



- Po dokončení instalace spusťte Smart USB Backup

4



- Vyberte USB disk, na který chcete vytvořit nástroj pro obnovu systémů.

5

- Jakmile bude vytvoření úspěšné, dialogové okno se samo zavře.
- Prosím stiskněte při startu tlačítko F12 pro vyvolání nabídky k obnově systému a následně bude váš systém obnoven.
- Tento proces trvá přibližně 30 minut. Čas závisí na rychlosti disku.

# Průvodce obnovením systému

## Obnovení systém (Obnovení operačního systému na vašem zařízení)

Pokud se vám stane něco s operačním systémem, běží pomalu nebo nesprávně, na skrytém oddílu nvašeho HDD je ukrytý nástroj pro obnovení systému do továrního nastavení.



### Poznámka:

- Pokud jste měnili váš HDD je možné, že nebude nástroj pro obnovení systému k dispozici.
- Nástroj pro obnovení systému je k dispozici pouze na zařízení se zakoupením systémem již z výroby.

## Vyvolání nástroje pro obnovení systému

Tento nástroj je již předinstalovaný z výroby. Pomocí menu nástroje pro obnovení systému bude vaše zařízení vráceno do továrního nastavení.

Během procházení nástroje budete průběžně informováni o průběhu procesu na obnovení systému.



### Vše připraveno pro obnovení systému

Ujistěte se, že máte zařízení připojené k elektrické síti

## Windows 10 - průvodce pro obnovení systému

1

Restartujte vaše zařízení

2



Během startování notebooku stiskněte a držte klávesu F9 k zobrazení nabídky.

3



Vyberte "Troubleshoot" pro vstup pro obnovení systému. (Také můžete zvolit "Continue" pro ukončení obnovení systému a pokračovat do Windows 10 obnovení dat nebo zálohy.)



### Na výběr jsou 2 možnosti obnovení systému

- **Reset this PC**  
Můžete si zvolit zda zachováte nebo vymažete veškerá data a poté přeinstalovat systém.
- **GIGABYTE Smart Recovery**  
Nastavení vašeho zařízení bude provedeno dle továrního nastavení.  
**Caution: All personal data and files will be lost.**



## ■ Reset this PC - Kompletní obnova PC

### ►Ponechat soubory a data

Vyberte účet a klikněte pokračovat. Všechny aplikace budou odstraněny, všechna nastavení budou zrušena a systém bude obnoven, ale vaše osobní data budou zachována.

### ►Odstranit vše

Všechny aplikace, nastavení a osobní soubory budou odstraněny.

### ⇒ Pouze odebrat osobní soubory

Pouze vaše osobní soubory budou odstraněny, ale nastavení PC bude zachováno.

### ⇒ Úplné vyčištění disku

Disk bude kompletně vymazán do továrního nastavení. Tato operace zabere více času. Klikněte na "Reset" pro provedení tohoto příkazu.



### Co se stane

- Všechny vaše aplikace a nastavení budou odstraněny.
- Nastavení systému bude obnoven do továrního nastavení (bez GIGABYTE aplikací).



## ■ GIGABYTE Smart Recovery



Obnovení systému bude aktivované a uvidíte vaše možnosti v dialogovém okně. Klínutím na "Yes" zahájíte obnovu.



### Upozornění

- Jakmile bude obnovení systému zahájené, vaše osobní data a soubory budou smazány a operační systém bude obnoven do továrního nastavení. Průběh obnovení systému můžete sledovat pomocí lišty. Prosím ujistěte se, že je notebook připojen k napájecímu zařízení.

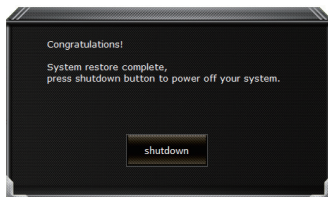

Po dokončení obnovení systému uvidíte možnost "Shutdown". Prosím klikněte na tuto volbu.



## ■ Rozšířená nabídka



### **Obnovení systému**

Systém bude vrácen na poslední známou funkční konfiguraci.



### **System Image Recovery**

Obnovení systému pomocí speciálního image souboru.



### **Automatická oprava**

Opraví problémy, které brání spuštění systému.



### **Příkazová řádka**

Použijte příkazovou řádku pro pokročilé řešení problémů



### **Nastavení UEFI Firmware**

Zde můžete změnit nastavení UEFI Firmware vašeho zařízení



### **Nastavení Startupu**

Změní nastavení Windows Startup

# Instalace ThermalPadu pro mSATA SSD na P55

Děkujeme, že jste si zakoupili notebook řady P55.

Pokud chcete instalovat mSATA SSD do Vašeho P55, doporučujeme si přečíst tyto instrukce, aby byla instalace úspěšná.

GIGABYTE není zodpovědný za jakékoliv poškození zařízení při SSD. Prosíme znovu si tuto možnost promyslete.

1



- Vyjmete vaše mSATA SSA.

2

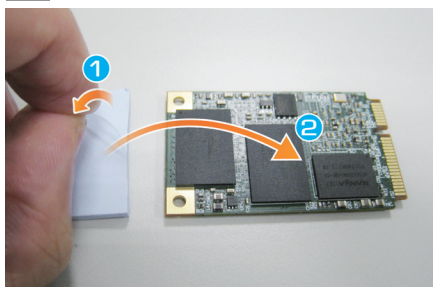

- Vyjmete tepelnou podložku.

3-1

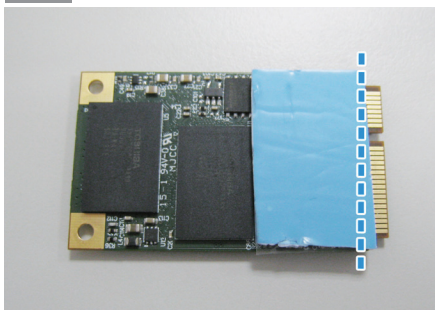

3-2

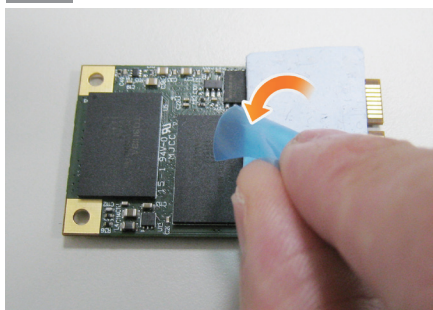

- Vložte jako je uvedeno na obrázku. Všimněte si pozice goldfingeru a zarovnejte tepelnou podložku se koncovkou SSD.

4-1



4-2



- Vložte zpět SSD do mSATA konektoru a přišroubujte.

#### Upozornění

- GIGABYTE není zodpovědný pokud si uživatel instalací způsobí poškození zařízení.  
Doporučujeme zaslat zařízení do autorizovaného servisního střediska GIGABYTE, pokud budete mít jakékoli pochybnosti.



### ■ Záruka a servis:

informace o záruce a servisu naleznete na našich stránkách  
<http://www.gigabyte.com/support-downloads/technical-support.aspx>

### ■ Často kladené dotazy:

Pro často kladené dotazy prosíme navštivte naše stránky  
<http://www.gigabyte.com/support-downloads/faq.aspx>

### ■ Často kladené dotazy:

Pro často kladené dotazy prosíme navštivte naše stránky  
<http://www.gigabyte.com/support-downloads/faq.aspx>

## Поздравляем Вас с приобретением нового ноутбука GIGABYTE.

Данное руководство поможет вам начать работу с новым устройством. На момент отгрузки все технические характеристики соответствуют заводским стандартам, и могут изменяться без предварительного уведомления: письменного или иного. Более полная информация доступна по адресу [www.gigabyte.com](http://www.gigabyte.com)

## Знакомство с ноутбуком GIGABYTE

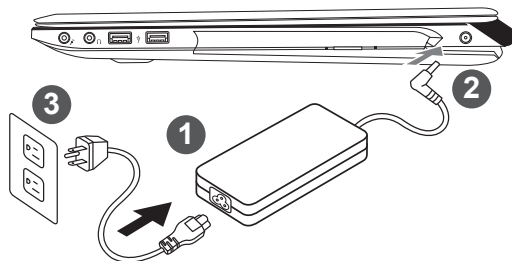

- 1 Соедините шнур питания и сетевой адаптер
- 2 Подключите адаптер переменного тока к гнезду DC на вашем компьютере
- 3 Подключите шнур питания к электрической розетке

### ⚠ ВНИМАНИЕ!

- Убедитесь, что ваш ноутбук подключен к заземленному адаптеру, прежде чем включать его в первый раз.
- При использовании ноутбука, включенного в сеть, электрическая розетка должна находиться в легко доступном месте, как можно более близко.
- Найдите лэйбл с указанным на нем входным и выходным током (input/output) на вашем ноутбуке и убедитесь, что эти значения совпадают с таковыми на адаптере питания. Некоторые ноутбуки могут иметь несколько номинальных режимов, в зависимости от доступных конфигураций.
- Информация адаптера питания: Входное напряжение: 100-240Vac / Входная частота: 50-60Hz / Номинальное выходное напряжение: 19.5V, 9.23A or 19.5V, 10.3A



## Включение ноутбука

Включив первый раз, не выключайте ноутбук до тех пор, пока не завершиться настройка операционной системы. ВНИМАНИЕ: Громкость звука не будет работать до завершения установки Windows®.

## Первая загрузка ноутбука

В зависимости от конфигурации вашего ноутбука, при включении его впервые, окно начальной загрузки Microsoft Windows® Boot Screen будет первым, что появится на экране. Следуйте инструкциям, появляющимся на экране компьютера, введите информацию о себе для завершения установки операционной системы Windows®.

## Вид сверху

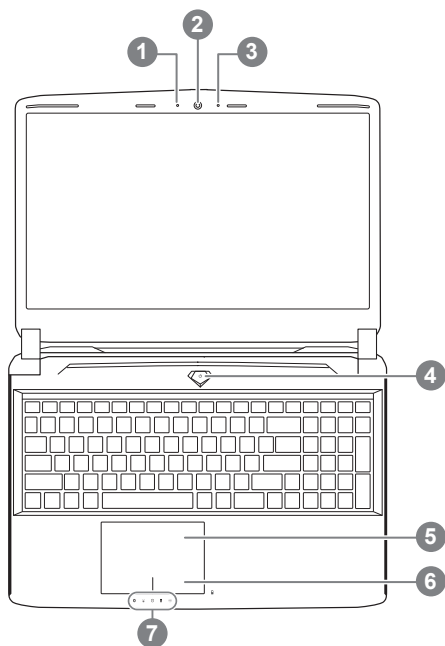

- 1 Статус работы веб камеры
- 2 видеочамера
- 3 микрофон
- 4 кнопка включения
- 5 сенсорная панель
- 6 кнопка индикатора заряда батареи ❶
- 7 индикаторы состояния ❷

❶ кнопка включения. Нажмите правую кнопку сенсорной панели для определения оставшегося заряда батареи. Как показано на изображении ниже, индикатор жизни батареи работает, когда ноутбук находится в выключенном состоянии, (режим гибернации или ожидания). (режим работы от батарей)

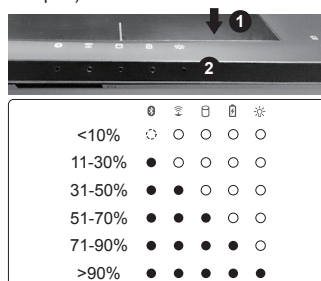

- ❷
  - 📶 индикатор Bluetooth
  - 🌐 индикатор статуса подключения к сети
  - 💾 индикатор работы жесткого диска
  - 🔋 индикатор статуса заряда батареи
  - ⚙️ индикатор режима работы

## Вид слева

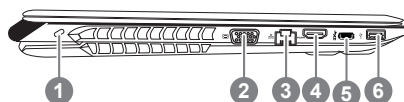

- 1 слот для замка Kensington
- 2 порт подключения внешнего монитора
- 3 порт локальной сети
- 4 HDMI порт
- 5 USB 3.1
- 6 USB 3.0

## вид справа

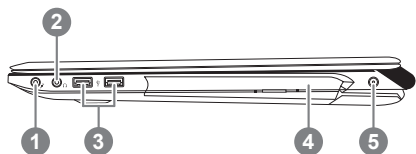

- 1 гнездо для микрофона
- 2 гнездо для наушников
- 3 USB 3.0
- 4 дисковод оптического привода
- 5 порт подключения адаптер

## вид снизу

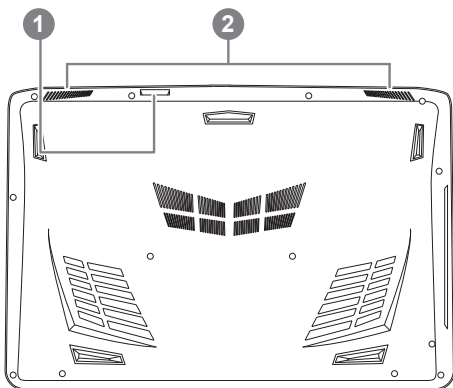

- 1 слот для чтения карт памяти
- 2 динамики















### Внимание:

НЕ вынимайте встроенную литиевую батарею. Для нужд технического обслуживания, пожалуйста, свяжитесь с местным авторизованным сервисным центром GIGABYTE.

# Горячие клавиши

Компьютер использует горячие клавиши или комбинации клавиш для доступа к большинству контроллеров компьютера, таким как яркость экрана и вывод звука.

Чтобы активировать горячие клавиши, нажмите и удерживайте клавишу <Fn> до того как нажимать другую клавишу горячей комбинации.

Функция	Описание	Описание
 Fn + ~	Воспроизведение	Контроль воспроизведения медиа
 Fn + F1	Переключатель тачпада	Включить / выключить встроенный тачпад
 Fn + F2	Переключатель LCD экрана	Выключить LCD экран (для включения нажмите любую клавишу или используйте тачпад)
 Fn + F3	Переключатель динамиков	Включить / выключить динамики
 Fn + F4	Переключатель спящего режима	Отправить компьютер в спящий режим
 Fn + F5	Убавить громкость	Уменьшить громкость звука
 Fn + F6	Прибавить громкость	Увеличить громкость звука
 Fn + F7	Переключатель дисплея	Переключить вывод изображения между встроенным экраном, внешним монитором (если он подключен) или обоими
 Fn + F8	Уменьшить яркость	Уменьшить яркость экрана
 Fn + F9	Увеличить яркость	Увеличить яркость экрана
 Fn + F10	Вебкамера	Включить / выключить встроенную вебкамеру
 Fn + F11	Переключатель режима "В самолёте"	Включить / выключить режим "В самолёте" *Данная функция доступна только в определенных регионах
 Fn + F12	Контроль подсветки клавиатуры	Включение и отключение подсветки клавиатуры

### ■ GIGABYTE Smart Manager

Вы можете активировать функцию Smart Manager двойным щелчком на иконке на рабочем столе, при условии что приобретенный вами ноутбук уже имеет заранее установленную операционную систему. Функция GIGABYTE Smart Manager является интерфейсом работы с иконками, позволяющей пользователю иметь доступ к общей системе установки и эксклюзивным утилитам GIGABYTE.

# Инструкция по использованию Smart USB Backup (первоначально: образ восстановления системы на USB)

## ⚠ ВНИМАНИЕ

- С помощью данного приложения Вы можете создать резервную копию образа восстановления системы на случай повреждения носителя.
- Пожалуйста, сделайте резервную копию Ваших данных, прежде чем восстанавливать систему посредством образа восстановления на USB.
- Прежде чем начать восстановление системы с помощью загрузочного USB диска, удостоверьтесь, что Вы сделали резервную копию Ваших данных.
- Пожалуйста, не выключайте систему и не отключайте питание в процессе восстановления системы с помощью USB диска.

1



- Пожалуйста, вставьте USB диск емкостью от 20 Гб для создания образа восстановления (Все данные на USB будут уничтожены в процессе создания образа восстановления - пожалуйста, убедитесь, что вы сохранили свои личные данные на другом носителе).

2



- Вставьте диск с драйверами в оптический привод Вашего ноутбука и установите "Smart USB Backup" (для ноутбуков без встроенного оптического привода: пожалуйста, используйте USB оптический привод или загрузите ПО с сайта <http://www.gigabyte.com>)

3



- После установки, запустите "Smart USB Backup".

4



- Выберите USB диск, на котором Вы хотите создать образ восстановления, из выпадающего списка и запустите создание образа.

5

- всплывающее окно оповестит о завершении процесса создания загрузочного диска с образом восстановления системы.
- Нажмите F12 при запуске компьютера, если Вы хотите восстановить систему. Выберите "Boot from recovery USB disk" для восстановления системы с USB диска.
- Время, которое потребуется для восстановления системы, составляет около 30 минут (в зависимости от модели Вашего USB диска).

# Инструкция по восстановлению ОС

## Восстановление операционной системы вашего ноутбука

При возникновении проблем с работой операционной системы, вы можете восстановить систему до заводских установок при помощи запасной полной версии ОС, которая хранится в закрытом разделе базы данных вашего ноутбука.



### Внимание

- если база данных отключена или закрытый раздел ее удален опция восстановления системы будет недоступна.
- опция восстановления системы доступна только для устройств с преустановленной ОС. Устройства с ОС ДОС не имеют доступа к функции восстановления ОС.

## Запуск функции Восстановление системы

Функция Восстановление системы преустановлена на вашем ноутбуке еще до отгрузки его с завода. Меню опций позволяет запустить функцию Восстановление системы для того, чтобы восстановить ОС до заводских конфигураций.

Краткая инструкция ниже показывает как запустить функцию Восстановление системы и обновить ОС.



### Готово

Убедитесь, что адаптер переменного тока подключен к розетке.

## Инструкция по восстановлению Windows 10

**1** Выключите и вновь запустите ноутбук.

**2**



В процессе включения ноутбука нажмите и удерживайте F9 для запуска утилиты восстановления.

**3**



Выберите “Troubleshoot” (устранение неисправностей) для входа в настройки восстановления. (Вы также можете выбрать “Continue” (продолжить) для выхода из системы восстановления и загрузки Windows 10 для резервного копирования ваших данных).



### Существуют две опции для восстановления системы

- **Reset this PC - Переустановка системы**  
Вы можете выбрать сохранить или удалить ваши файлы и переустановить Windows без потери ваших файлов.
- **GIGABYTE Smart Recovery**  
Установки вашего ПК будут возвращены к заводским установкам по умолчанию.  
**ВНИМАНИЕ: Все персональные данные и файлы будут удалены.**





## ■ Выберите “Reset this PC” (Переустановка системы)

### ► Keep my files Сохранить мои файлы

Выберите учетную запись для продолжения.

Все приложения будут удалены, а настройки вернуться к состоянию по умолчанию ОС (без приложений GIGABYTE), однако ваши персональные файлы будут сохранены.

### ► Remove everything Удалить всё

Все приложения, настройки и личные файлы будут удалены.

#### ⇒ Just remove my files - Удалить только мои файлы

Только личные данные и файлы будут удалены, настройки компьютера будут сохранены.

#### ⇒ Fully clean the drive - Полностью очистить диск

Диск будет полностью возвращен к заводскому состоянию по умолчанию. Эта процедура занимает больше времени. > [Нажмите “Reset” для выполнения функции восстановления.]



### В данном случае произойдет следующее:

- Все ваши личные файлы и приложения будут удалены.
- Настройки вашего ПК вернуться к заводским по умолчанию (без приложений GIGABYTE).



## ■ GIGABYTE Smart Recovery



Функция восстановления будет активирована и вы увидите кнопки опций восстановления в окне. Нажмите “Yes”/Да для начала работы.



### ВНИМАНИЕ

- При выборе “Recovery” / Восстановления, ваши личные данные и файлы будут удалены как только ноутбук начнет процедуру восстановления, а операционная система будет восстановлена к заводским настройкам по умолчанию. Индикатор прогресса появится в окне с началом работы процесса восстановления. Пожалуйста, убедитесь, что Ваш ноутбук подключен к сети питания через АС адаптер и не выключайте ноутбук.

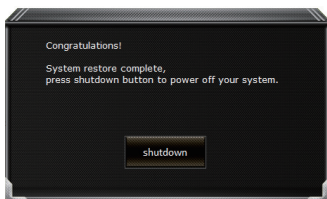

После завершения системы восстановления, пожалуйста, нажмите “Shutdown” / Выключить.



## ■ Расширенные опции



### **System Restore Восстановление системы**

Используйте точку восстановления, ранее созданную на вашем ПК, для восстановления Windows.



### **System Image Recovery Восстановление образа системы**

Восстановление Windows с помощью конкретного файла образа системы.



### **Startup Repair Устранение проблем загрузки**

Устранить проблемы, не позволяющие Windows загрузиться.



### **Command Prompt Командная строка**

Использовать командную строку для продвинутого устранения неполадок.



### **UEFI Firmware Settings Настройки прошивки UEFI**

Изменить настройки прошивки UEFI вашего ПК.



### **Startup Setting Настройки запуска**

Изменить настройки запуска Windows.

# Установка термической наклейки для M.2 SSD в P55

Мы Вас Благодарим за приобретение ноутбука P55! Если вы желаете установить M.2 SSD в Ваш P55, мы Вас рекомендуем прочитать нижеследующую инструкцию перед установкой. GIGABYTE не несет ответственности за любой ущерб, нанесен вендорами или пользователем во время установки.

1

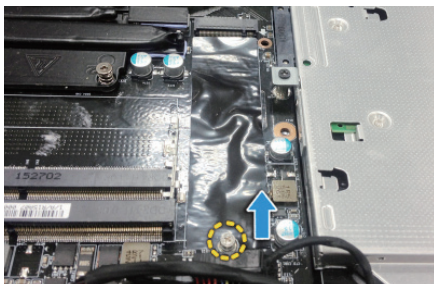

- Откройте заднюю крышку и разпустите винт на M.2 SSD.

2



- Вскройте пленку на термической площадке.

3-1

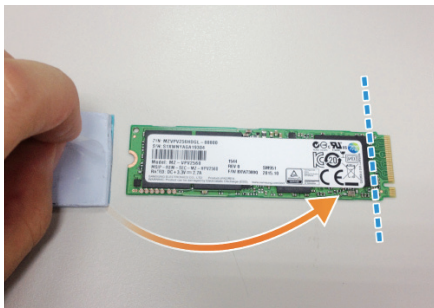

3-2



- Наложите термическую площадку на M.2 SSD, совмещая её с позицию голдфингера чипа на правой стороне, и вскройте голубую пленку

4-1



4-2



- Вставьте SSD в слот M.2 и затяните винт.

**⚠ ВНИМАНИЕ**

- GIGABYTE не несет ответственности за ущерб, нанесенный устройств в результате действий пользователя. Мы рекомендуем обратиться в наш авторизованный сервисный центр в случае возникновения каких-либо вопросов. Сервисные сборы зависят от локальных условий сервиса.

Вебсайт: <http://www.gigabyte.com/index.aspx>

### ■ Сервисное обслуживание:

Подробную информацию по обслуживанию можно найти на официальном сайте GIGABYTE по ссылке:

<http://www.gigabyte.com/support-downloads/technical-support.aspx>

### ■ Часто задаваемые вопросы:

Список часто задаваемых вопросов можно найти, перейдя по ссылке

<http://www.gigabyte.com/support-downloads/faq.aspx>