

**GIGABYTE™**

GIGABYTE

# P37 USER'S MANUAL

使 用 手 冊

English



\* Images Used for Reference Only

V3.0

## Congratulations on your purchase of the GIGABYTE Notebook.

This manual will help you to get started with setting up your notebook. The final product configuration depends on the model at the point of your purchase. GIGABYTE reserves the right to amend without prior notice. For more detailed information, please visit our website at [www.gigabyte.com](http://www.gigabyte.com)

## Using GIGABYTE Notebook for the First Time

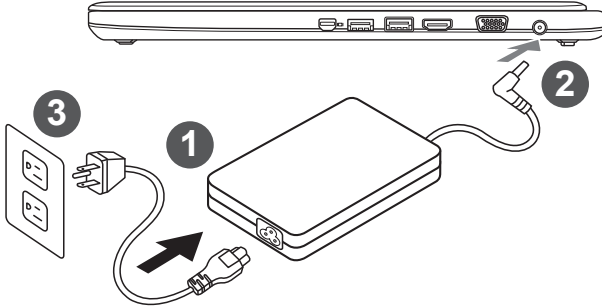

- 1 Connect the power cord to the AC adapter.
- 2 Connect the AC adapter to the DC-in jack on the right side of the notebook.
- 3 Connect the power cord to the power outlet.

### **! IMPORTANT!**

- Ensure that your Notebook PC is connected to a grounded power adapter before turning it on for the first time.
- When using your Notebook PC on power adapter mode, the socket outlet must be near to the unit and easily accessible.
- Locate the input/output rating label on your Notebook PC and ensure that it matches the input/output rating information on your power adapter. Some Notebook PC models may have multiple rating output currents based on the available SKU.
- Power adapter information:
  - Input voltage: 100-240Vac
  - Input frequency: 50-60Hz
  - Rating output voltage: 19V or 19.5V

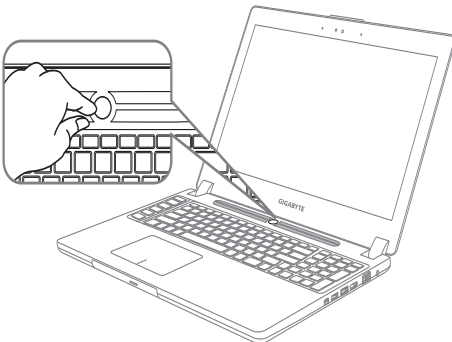

### Switching on the Power

After you turn on the Notebook for the very first time, do not turn it off until the operating system has been configured. Please note that the volume for the audio will not function until Windows® Setup has completed.

## Booting Up the Notebook for the First Time

Depending on your configuration, the Microsoft® Windows® Boot Screen will be the first screen that you will see as the notebook starts up. Follow the on-screen prompts and instructions and enter your personal information to complete the setup of the Windows® Operating System.

## Your GIGABYTE Notebook Tour

### Top View & Front View

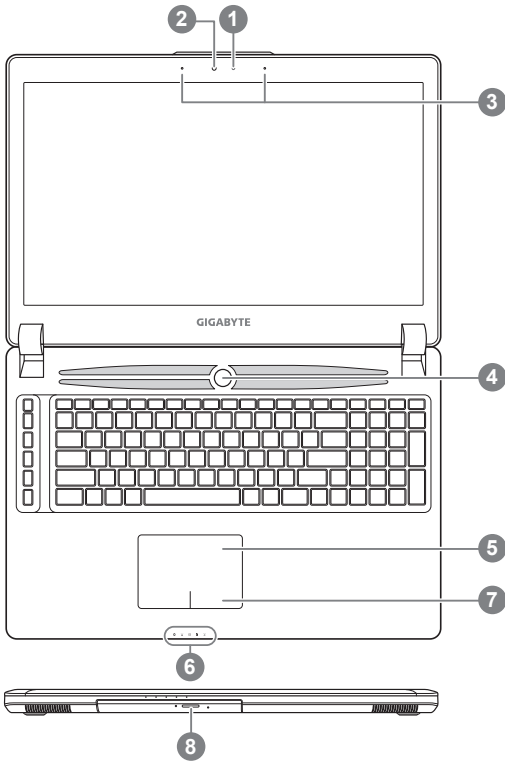

- 1 Light sensor
- 2 Webcam
- 3 Microphone
- 4 Power Button
- 5 TouchPad
- 6 LED Indicators<sup>①</sup>
- 7 Battery Indicator Button <sup>②</sup>
- 8 Swappable Storage Bay

- ①
  - Bluetooth Status LED
  - Wireless Lan Status LED
  - HDD Status LED
  - Battery Status LED
  - Power Status LED
- ② Press the right button of touchpad to check the remaining battery power. Right click to show the remaining power percentage. As shown below, the battery life indicator is available when the laptop is shut down, in stand-by or hibernation.(Battery mode)

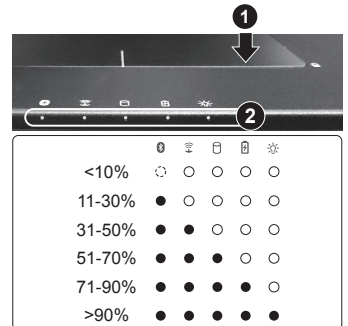

## Left View

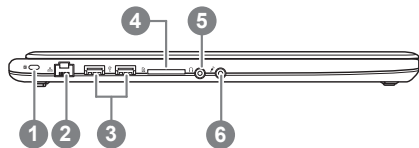

- 1 Kensington Lock Slot
- 2 Ethernet Port
- 3 USB 2.0 Port
- 4 SD Card Reader
- 5 Headphone Jack
- 6 Microphone Jack

## Right View

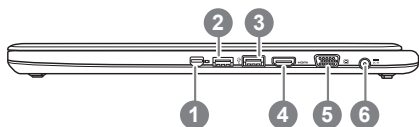

- 1 Mini Display Port
- 2 USB 3.0 Port
- 3 USB 3.0 Port (USB Charge)
- 4 HDMI Port
- 5 External Display (VGA) Port
- 6 DC-in Jack

## Base View

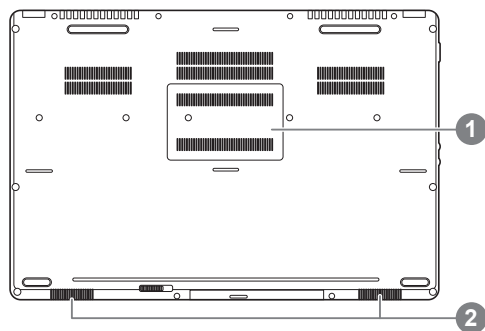

- 1 Memory Compartment
- 2 Speakers

















### Warning:

DO NOT remove the built-in lithium battery. For any service needs, please contact your local GIGABYTE Authorized Service Center.









# Hotkeys

The computer employs hotkeys or key combinations to access most of the computer's controls like screen brightness and volume output. To activate hotkeys, press and hold the <Fn> key before pressing the other key in the hotkey combination.

Hotkey	Function	Description
Fn+ESC 	Eject ODD	Eject ODD
Fn+F1 	Sleep	Put the computer in Sleep mode.
Fn+F2 	Wireless LAN	Enables/disable the Wireless LAN function.
Fn+F3 	Brightness Down	Decrease the screen brightness.
Fn+F4 	Brightness Up	Increase the screen brightness.
Fn+F5 	Display Toggle	Switch display output between the display screen, external monitor (if connected) and both.
Fn+F6 	Touchpad Toggle	Turn the internal touchpad on and off.
Fn+F7 	Speaker Toggle	Turn the speaker on and off.
Fn+F8 	Volume Down	Decrease the sound volume.
Fn+F9 	Volume Up	Increase the sound volume.
Fn+F10 	Screen Display Toggle	Turn the screen display on and off.
Fn+F11 	Bluetooth	Enable/disable the Bluetooth function.
Fn+F12 	Webcam	Turn the internal webcam on and off.
Fn+Space 	Keyboard Backlight Toggle	Turn the keyboard backlight on and off.

## Macro key

Macro keys can be set via Macro Hub, setting combination keys for complicated and/or general operation.

Macro key	Macro key	Description
	G	Macro group switch, press around 3 seconds as hardware switch on/off.
	G1	User Programmable Macro key
	G2	User Programmable Macro key
	G3	User Programmable Macro key
	G4	User Programmable Macro key
	G5	User Programmable Macro key

# Swappable bay Application

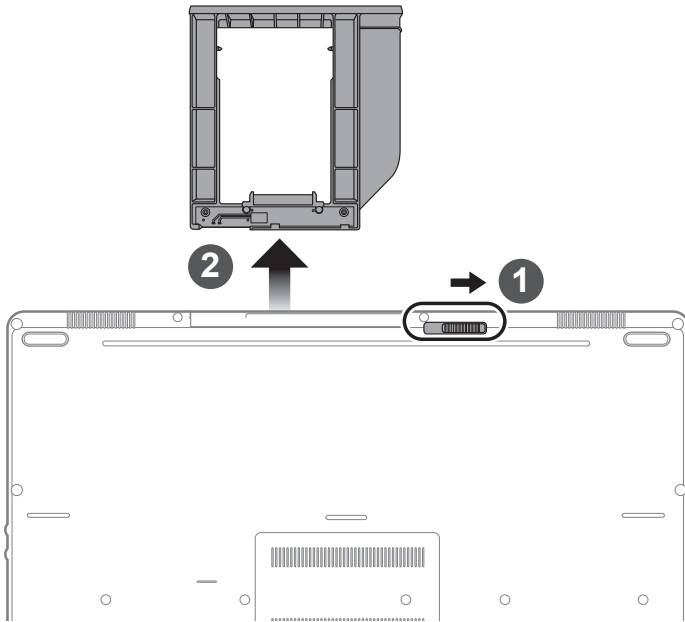

- 1 Unlock swappable bay locker.
- 2 Draw the swappable bay out.

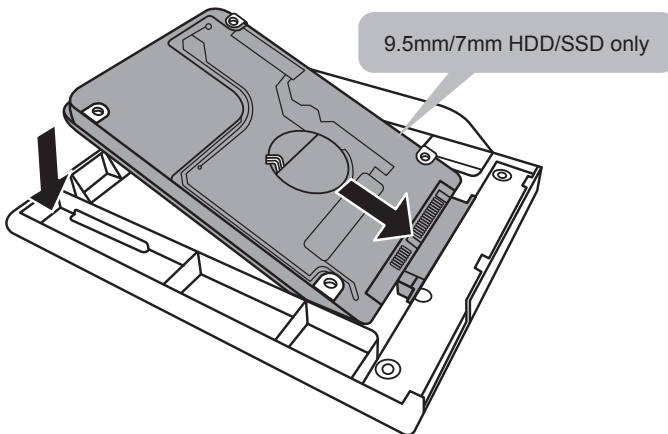

Connect the HDD or SSD pin by sliding it into the connector.

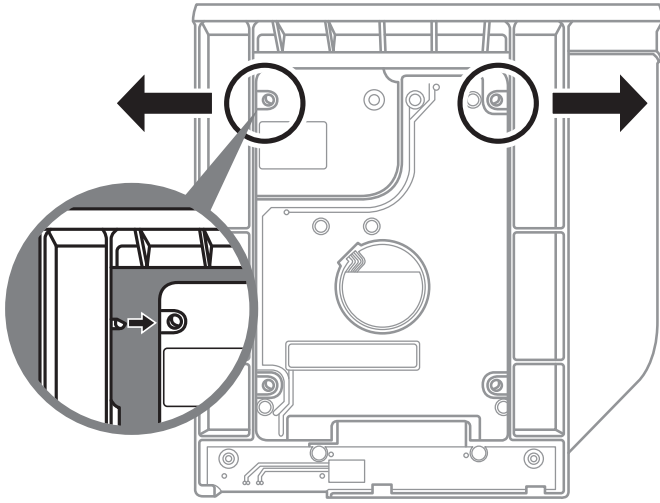

Gently push the plastic frame outwards. Slide in the HDD or SSD until it locks into place. There will be a slight click.

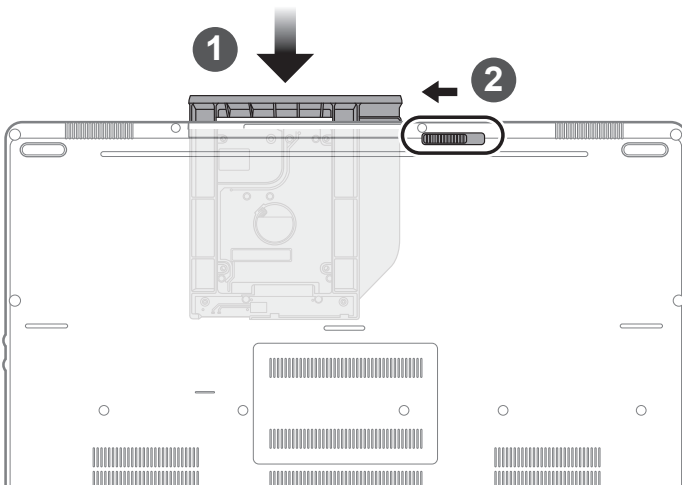

- 1 Pull swappable bay back to slot.
- 2 Lock swappable bay locker.

# Macro Hub Instruction

Welcome to use Macro Hub ! Macro Hub makes it much easier for you to control your Macro Key on P37. You can deal with complex key stroke combination by just one press on macro key, which brings you benefits both in work and game. Before using Macro Hub, please read following guide, thanks.

## 1 Launch Macro Hub



You can find the shortcut of Macro Hub on desktop. Just double click it.

## 2 The overview of Macro Hub

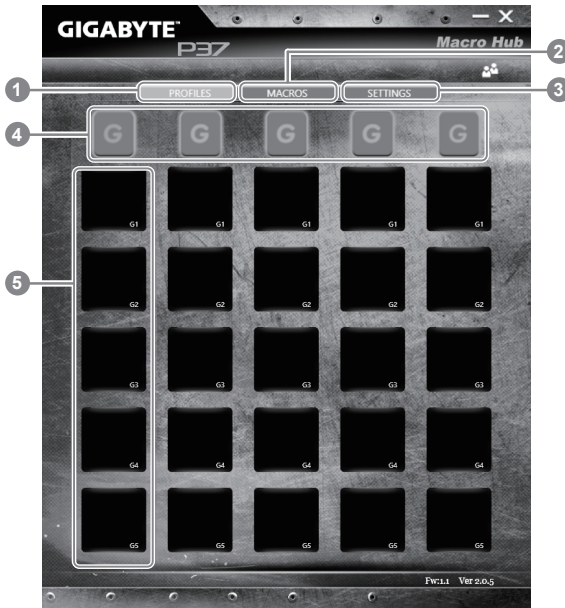

- 1 Profiles: View your current macro command settings.
- 2 Macros: Edit macro command functions and settings.
- 3 Settings: Update Macro Hub version or renew macro hub settings.
- 4 Macro Key Group Indicators: Indicate the activated Macro Key Group (the activated group indicator will light up)
- 5 Macro Key Function: Show the programmed Macro functions under the Macro Key Group, from G1 to G5.

### 3 Using Macro Hub

#### 1 Set Macro Key to basic function

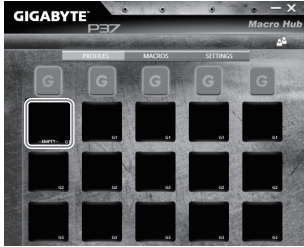

a. Click the G button on the left-top of the keyboard to switch to the Macro Key group you would like to use

b. Click the Macro Key function brick

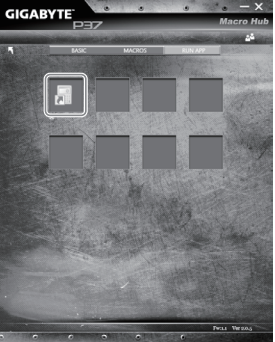

c. Double-click the function you would like to use(ex. Media Player) in the Basic or Macros function area.

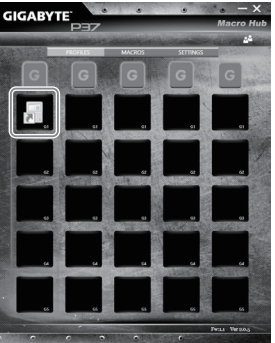
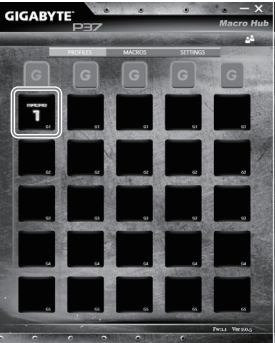
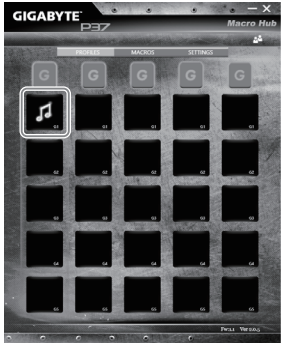

d. Complete the setting

**2 Edit macro command functions and settings.**

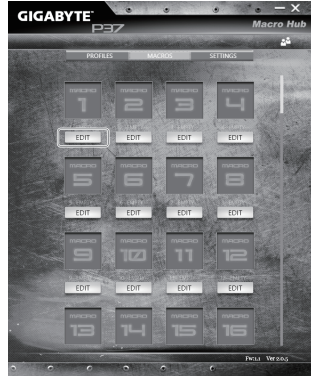

a. Click "Macros" (you can set up to 100 sets of macro)

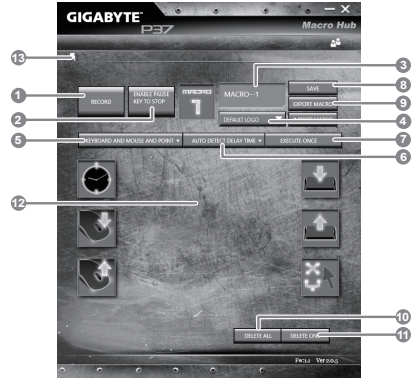

b. Overview of macro record panel (you can record your own macro here)

1. Start recording: Click when you're about to record the macro
2. Pause key Switch: Enable/Disable Pause key to stop recording.
3. Macro Name: Set the name of this macro
4. Import icon: Set icon for this macro. You can use default icon or upload your own icon
5. Record type: You can choose to record only mouse(or keyboard) movement, or record both. You can also decide to or not to record mouse position.
6. Record interval: You can decide to or not to record the interval of each movement(or You can set fixed interval time between every movement)
7. Execution way: You can set the macro execution way (execution once, repeat execution or repeat execution with deep press)
8. Export macro: Export your macro
9. Import macro: Import the macro
10. Delete all: Delete all movement in this macro

- 11. Delete selected: Delete selected movement
- 12. Movement list: it shows all movement you record
- 13. Exit: The system will inquire you if to save the recorded macro



c. Start to record macro: When you click start button, the macro engine will start to record macro. All movement you made(mouse/keyboard) will be shown in the movement list. You can decide to use “pause” key or mouse click on stop button to stop recording based on your record range. Finishing recording: When you have done all movement, click exit button. The Macro Engine will inquire you if you want to save the macro. Click Yes then you can finish the record of your own macro.

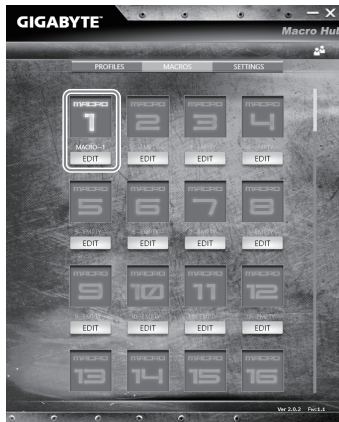

d. Complete the setting.

### 3 Edit "Settings" of Macro Hub

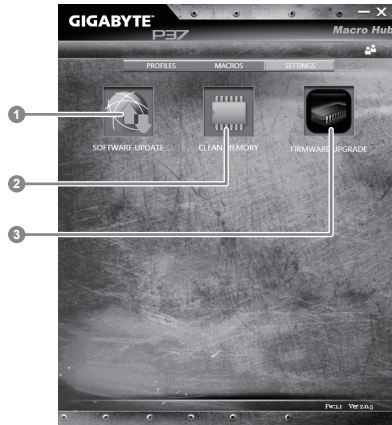

1. Software update: Update latest version of GIGABYTE Macro Hub
2. Clean memory: Erase current Macro Hub settings
3. Firmware Upgrade: Upgrade Macro Key firmware



# Setup Your System for RAID 0/1

## ⚠ WARNING

- Please backup your data before you build and run RAID 0/1 on your system.
- RAID 1 needs two storage drives of the same specification and capacity in your laptop.
- RAID 0 needs two storage drives of the same specification in your laptop. Different capacity is acceptable.

1



- Please install the HDDs/SSDs you would like to build your RAID 0 configuration in the system, then turn on the system.

2

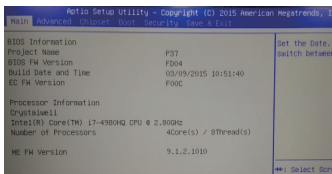

- Press F2 right after turning on and enter the BIOS.

3

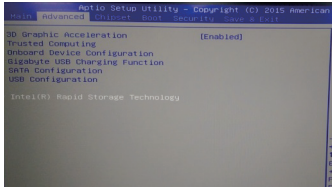

- Press right click and enter [Advanced] menu and choose [Intel Rapid Storage Technology]

4

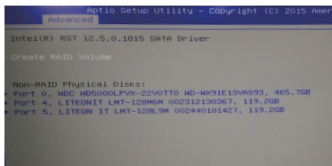

- Select [Create RAID Volume]

5

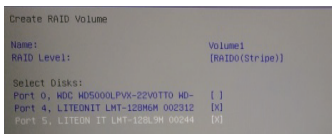

- Select the HDD/SSDs you would like to build RAID 0 with [X]. In this example, the RAID 0 is composed with 2 SSD. After the selection, choose Create Volume

6

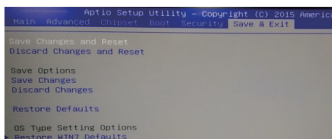

- The Creation of RAID 0 is finished now and please remember to save it in Save & Exit page and reboot the system. Then you can start to install the OS in your new disk volume

## ⚠ WARNING

- You can backup original recovery image through this application in case of losing by device damage.
- You can backup original recovery image to USB disk and restore the system if any storage system replacement with the recovery USB disk.
- Before you restore the system through the recovery USB disk, please make sure that you have already made the backup of your data.
- Please DO NOT shut down or un-plug the system when performing backup through recovery USB disk.

**1**

- Please plug in the USB disk which is at least 20GB in capacity to make the original image (backup the data in USB first. All data will be eliminated during the creation of recovery USB disk)

**2**

- Insert the driver disk to your optical drive and run the install of “Smart USB Backup” (for none-ODD model, please use USB ODD device or download from <http://www.gigabyte.com>)

**3**

- Run the “Smart USB Backup” after finishing the install.

**4**

- Select your USB disk from the drop-down list and start to create the recovery USB disk.

**5**

- The window will pop out when the creation of recovery disk is done.
- Please press F12 on starting the system when you need to restore the system. Select “boot from recovery USB disk” and the system will be restored.
- The time needed for restore will be around 30 mins(time needed may vary by USB disk model) .

## Recovery Guide

### System Recovery (Restore your laptop operating system)

When something is going wrong with the laptop operating system, the storage of the laptop has a hidden partition containing a full back up image of the operating system that can be used to restore the system to factory default settings.



#### Note

- If the storage has been switched or the partition deleted, the recovery option will no longer be available and a recovery service will be needed.
- The recovery function is only available on devices with O/S preinstalled. Devices with DOS do not have the recovery function.

### Launch System Recovery

The system recovery feature is preinstalled before the laptop is shipped from the factory. The option menu allows you to launch the Windows recovery tool to reinstall the operating system to factory default.

The brief introduction below will show you how to start the recovery tool and restore your system.



#### All ready to go

Make sure your PC is plugged in. This will take a few minutes.

## Windows 7 Recovery Guide

1

Turn off and restart the laptop.

2



During the laptop turn on process, press and hold F9 key to launch the tool.

3

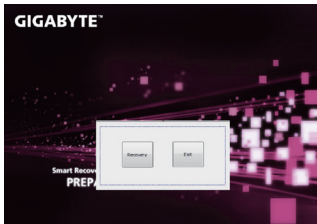

The recovery will be activated and you will see the option buttons on the window. Click on "Recovery" to start it.



#### Caution

Once the "Recovery" is selected, your personal data and files will be deleted after the laptop starts restoring, and the operating system will be reset to factory default settings.

4

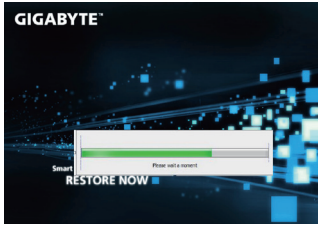

A progress indicator bar will show on the window when the recovery process is running. Please make sure the AC-adapter is plugged in and do not turn off the laptop.

5



Reboot the laptop after the system recovery is complete.

## Windows 8.1 Recovery Guide

1

Turn off and restart the laptop.

2



During the laptop turn on process, press and hold F9 key to launch the tool.

3



Choose “Troubleshoot” to enter the recovery settings. (Also you can choose “Continue” to exit recovery system and continue to Windows 8.1 for files or data backup.)



### There are two options for system recovery

- **Refresh your PC**

You can refresh your laptop to improve the system stability without losing your files.

- **Reset your PC**

If you want to remove all of your files, you can reset your PC completely.

**Caution: All personal data and files will be lost.**

## 4



### ■ Choose “Refresh your PC”

Choose an account to continue.



#### Here are what will happen

- Your files and personalization settings won't be changed.
- Your PC settings will be restored to factory default settings.
- Apps from Windows Store will be kept.
- Apps you installed from discs or websites will be removed.
- A list of removed apps will be saved on your desktop.



### ■ Choose “Reset your PC”

#### ► Just remove my files

Only personal data and files will be removed, but computer settings will be kept.

#### ► Fully clean the drive

The drive will be completely restored to factory default settings. It takes more time. > [Click on “Reset” to execute recovery function.]



#### Here are what will happen

- All of your personal files and apps will be removed.
- Your PC settings will be restored to factory default settings.



### ■ Advanced options



#### System Restore

Use a restore point recorded on your PC to restore Windows.



#### System Image Recovery

Recover Windows using a specific system image file.



#### Automatic Repair

Fix problems that keep Windows from loading.



#### Command Prompt

Use the Command Prompt for advanced troubleshooting.



#### UEFI Firmware Settings

Change settings in your PC's UEFI firmware.



#### Startup Settings

Change Windows Startup behavior.

## ■ **Warranty & Service:**

Warranty and service and related information please refer to the warranty card or GIGABYTE service website as the below link:

<http://www.gigabyte.com/support-downloads/technical-support.aspx>

## ■ **FAQ:**

FAQ (Frequent Asked Questions) please refer to the below link:

<http://www.gigabyte.com/support-downloads/faq.aspx>

