

**GIGABYTE™**

**P35** USER'S MANUAL  
使 用 手 冊

English

## Congratulations on your purchase of the GIGABYTE Notebook.

This manual will help you to get started with setting up your notebook. The final product configuration depends on the model at the point of your purchase. GIGABYTE reserves the right to amend without prior notice. For more detailed information, please visit our website at [www.gigabyte.com](http://www.gigabyte.com)

## Using GIGABYTE Notebook for the First Time

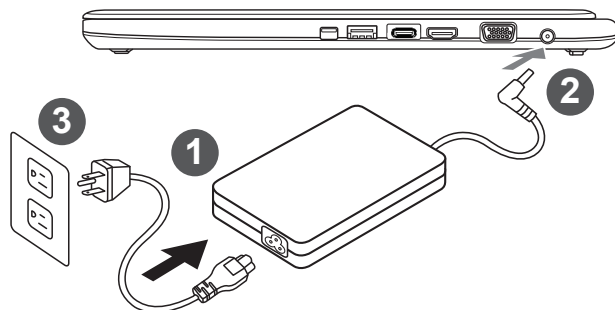

- 1 Connect the power cord to the AC adapter.
- 2 Connect the AC adapter to the DC-in jack on the right side of the notebook.
- 3 Connect the power cord to the power outlet.



### IMPORTANT

- Ensure that your Notebook PC is connected to a grounded power adapter before turning it on for the first time.
- When using your Notebook PC on power adapter mode, the socket outlet must be near to the unit and easily accessible.
- Locate the input/output rating label on your Notebook PC and ensure that it matches the input/output rating information on your power adapter. Some Notebook PC models may have multiple rating output currents based on the available SKU.
- Power adapter information: Input voltage: 100-240Vac, - Input frequency: 50-60Hz, - Rating output voltage: 19V or 19.5V

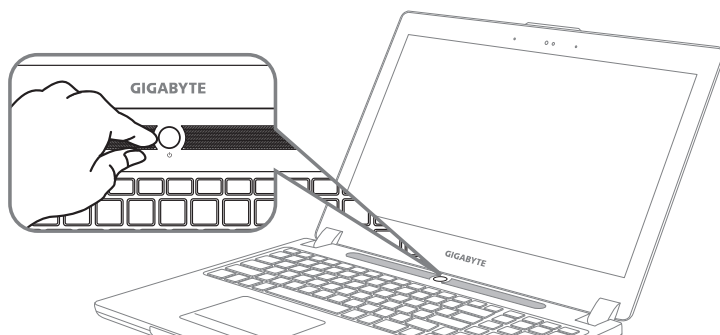

## Switching on the Power

After you turn on the Notebook for the very first time, do not turn it off until the operating system has been configured. Please note that the volume for the audio will not function until Windows® Setup has completed.

## Booting Up the Notebook for the First Time

Depending on your configuration, the Microsoft® Windows® Boot Screen will be the first screen that you will see as the notebook starts up. Follow the on-screen prompts and instructions and enter your personal information to complete the setup of the Windows® Operating System.

## Your GIGABYTE Notebook Tour

### Top View & Front View

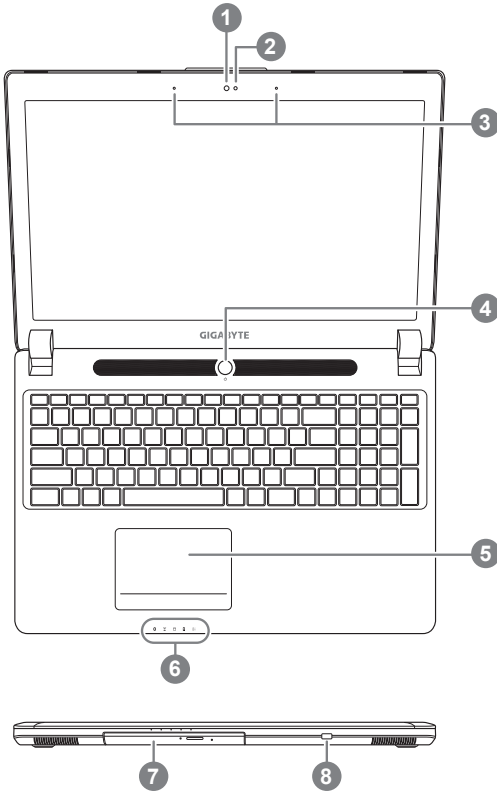

- 1 Webcam
- 2 Light sensor
- 3 Microphone
- 4 Power Button
- 5 TouchPad
- 6 LED Indicators ❶
- 7 Swappable Storage Bay
- 8 Power Check Button ❷

- ❶
  - 📶 Bluetooth Status LED
  - 📶 Wireless Lan Status LED
  - 📀 HDD Status LED
  - 🔋 Battery Status LED
  - ☀️ Power Status LED

❷ As shown below, the battery life indicator is available when the laptop is shut down, in stand-by or hibernation. (Battery mode)

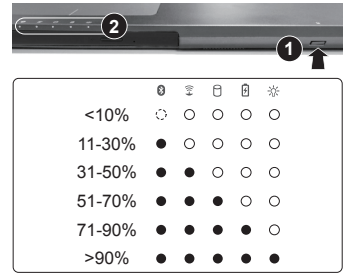

## Left View

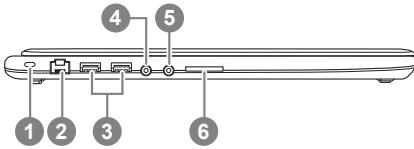

- 1 Kensington Lock Slot
- 2 Ethernet Port
- 3 USB 3.0 Port
- 4 Headphone Jack
- 5 Microphone Jack
- 6 SD Card Reader

## Right View

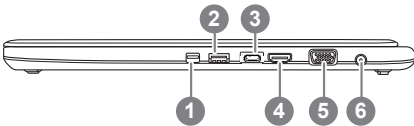

- 1 MiniDisplayPort
- 2 USB 3.0 Port (USB Charge)
- 3 USB 3.1 Port
- 4 HDMI Port
- 5 External Display (VGA) Port
- 6 DC-in Jack

## Base View

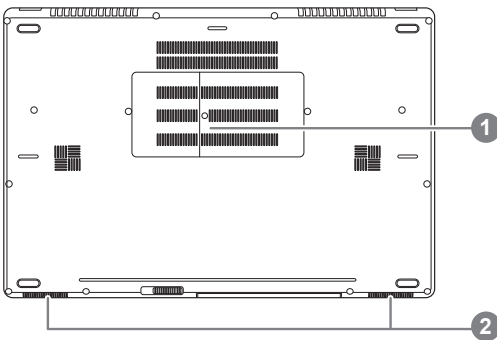

- 1 Memory Compartment
- 2 Speakers

















**Warning:**

DO NOT remove the built-in lithium battery. For any service needs, please contact your local GIGABYTE Authorized Service Center.

# Hotkeys

The computer employs hotkeys or key combinations to access most of the computer's controls like screen brightness and volume output. To activate hotkeys, press and hold the <Fn> key before pressing the other key in the hotkey combination.

Hotkey	Function	Description
Fn+ESC 	Eject ODD	Eject ODD
Fn+F1 	Sleep	Put the computer in Sleep mode.
Fn+F2 	Wireless LAN	Enables/disable the Wireless LAN function.
Fn+F3 	Brightness Down	Decrease the screen brightness.
Fn+F4 	Brightness Up	Increase the screen brightness.
Fn+F5 	Display Toggle	Switches display output between the display screen, external monitor (if connected) and both.
Fn+F6 	Touchpad Toggle	Turn the internal touchpad on and off.
Fn+F7 	Speaker Toggle	Turn the speaker on and off.
Fn+F8 	Volume Down	Decrease the sound volume.
Fn+F9 	Volume Up	Increase the sound volume.
Fn+F10 	Screen Display Toggle	Turn the screen display on and off.
Fn+F11 	Bluetooth	Enable/disable the Bluetooth function.
Fn+F12 	Webcam	Turn the internal webcam on and off.
Fn+Space 	Keyboard Backlight Toggle	Turn the keyboard backlight on and off.

# Swappable bay Application

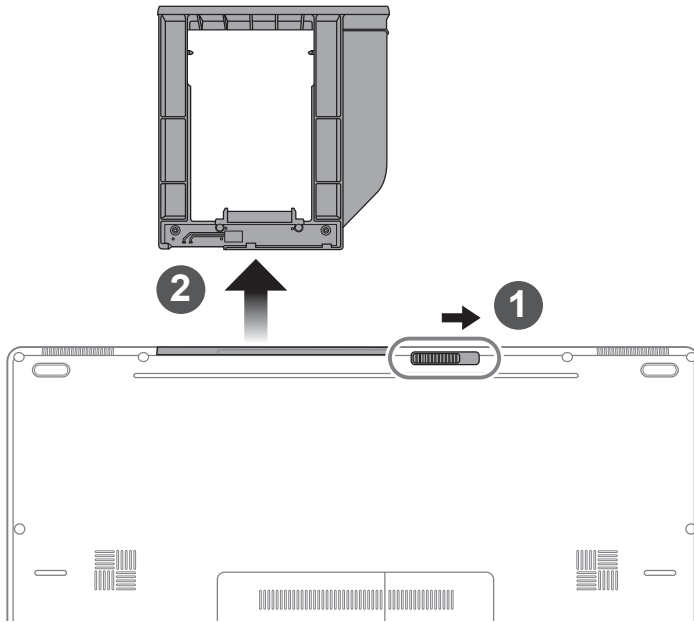

- 1 Unlock swappable bay locker.
- 2 Draw the swappable bay out.

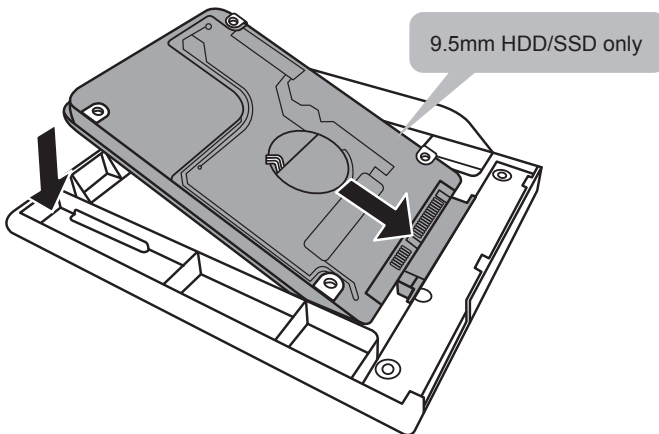

Connect the HDD or SSD pin by sliding it into the connector.

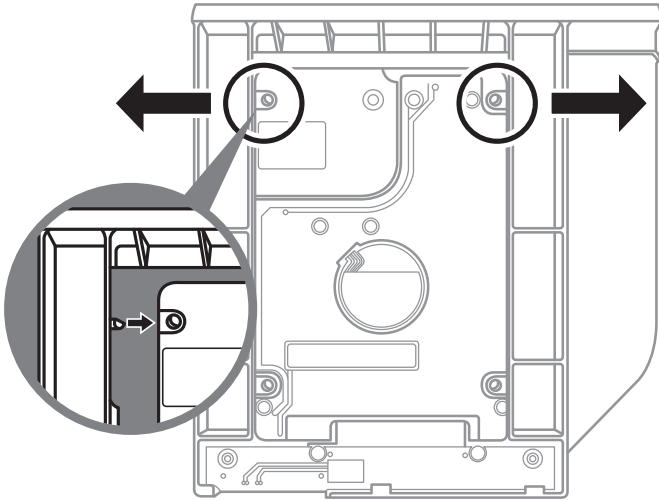

Gently push the plastic frame outwards. Slide in the HDD or SSD until it locks into place. There will be a slight click.

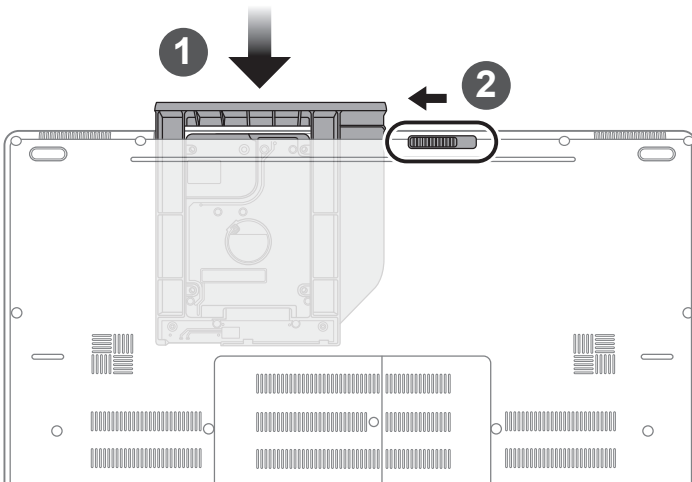

- 1 Pull swappable bay back to slot.
- 2 Lock swappable bay locker.

## ■ GIGABYTE Smart Manager

You can activate GIGABYTE Smart Manager by double clicking on the shortcut icon on the desktop if the machine you purchased has the operation system built-in. GIGABYTE Smart Manager is an icon-based control interface, enabling users to intuitively access common system setup as well as GIGABYTE exclusive utilities. Please be noted that the GIGABYTE Smart Manager interface, icons, utilities and software versions may vary based on the purchased models. Please operate GIGABYTE Smart Manager according to the actual version built-in.



# Smart USB Backup Guide

## ⚠ WARNING

- You can backup original recovery image through this application in case of losing by device damage.
- You can backup original recovery image to USB disk and restore the system if any storage system replacement with the recovery USB disk.
- Before you restore the system through the recovery USB disk, please make sure that you have already made the backup of your data.
- Please DO NOT shut down or un-plug the system when performing backup through recovery USB disk.

1



- Please plug in the USB disk which is at least 20GB in capacity to make the original image (backup the data in USB first. All data will be eliminated during the creation of recovery USB disk)

2



- Insert the driver disk to your optical drive and run the install of "Smart USB Backup" (for none-ODD model, please use USB ODD device or download from <http://www.gigabyte.com>)

3



- Run the "Smart USB Backup" after finishing the install.

4



- Select your USB disk from the drop-down list and start to create the recovery USB disk.

5

- The window will pop out when the creation of recovery disk is done.
- Please press F12 on starting the system when you need to restore the system. Select "boot from recovery USB disk" and the system will be restored.
- The time needed for restore will be around 30 mins(time needed may vary by USB disk model) .

# Recovery Guide

## System Recovery (Restore your laptop operating system)

When something is going wrong with the laptop operating system, the storage of the laptop has a hidden partition containing a full back up image of the operating system that can be used to restore the system to factory default settings.



### Note

- If the storage has been switched or the partition deleted, the recovery option will no longer be available and a recovery service will be needed.
- The recovery function is only available on devices with O/S preinstalled. Devices with DOS do not have the recovery function.

## Launch System Recovery

The system recovery feature is preinstalled before the laptop is shipped from the factory. The option menu allows you to launch the Windows recovery tool to reinstall the operating system to factory default.

The brief introduction below will show you how to start the recovery tool and restore your system.



### All ready to go

Make sure your PC is plugged in. This will take a few minutes.

## Windows 7 Recovery Guide

**1** Turn off and restart the laptop.

**2**



During the laptop turn on process, press and hold F9 key to launch the tool.

**3**



The recovery will be activated and you will see the option buttons on the window. Click on "Recovery" to start it.



### Caution

Once the "Recovery" is selected, your personal data and files will be deleted after the laptop starts restoring, and the operating system will be reset to factory default settings.

4



A progress indicator bar will show on the window when the recovery process is running. Please make sure the AC-adapter is plugged in and do not turn off the laptop.

5



Reboot the laptop after the system recovery is complete.

## Windows 10 Recovery Guide

1

Turn off and restart the laptop.

2



During the laptop turn on process, press and hold F9 key to launch the tool.

3



Choose "Troubleshoot" to enter the recovery settings. (Also you can choose "Continue" to exit recovery system and continue to Windows 10 for files or data backup.)



### There are two options for system recovery

- **Reset this PC**  
You can choose to keep or remove your files and then reinstalls Windows without losing your files.
- **GIGABYTE Smart Recovery**  
Your PC settings will be restored to factory default settings.  
**Caution: All personal data and files will be lost.**

4



## ■ Choose “Reset this PC”

### ▶ Keep my files

Choose an account to continue. All apps will be removed, and settings will back to pure O/S (without GIGABYTE app), but your personal files will be kept.

### ▶ Remove everything

All apps, setting and personal files will be removed.

#### ⇒ Just remove my files

Only personal data and files will be removed, but computer settings will be kept.

#### ⇒ Fully clean the drive

The drive will be completely restored to factory default settings. It takes more time. > [Click on “Reset” to execute recovery function.]



### Here are what will happen

- All of your personal files and apps will be removed.
- Your PC settings will be restored to pure O/S (without GIGABYTE app) .



## ■ GIGABYTE Smart Recovery



The recovery will be activated and you will see the option buttons on the window. Click on “Yes” to start it.



### Caution

- Once the “Recovery” is selected, your personal data and files will be deleted after the laptop starts restoring, and the operating system will be reset to factory default settings.
- A progress indicator bar will show on the window when the recovery process is running. Please make sure the AC-adaptor is plugged in and do not turn off the laptop.



After the system recovery is completed, you will see the option button on the window, please click on “Shutdown”.



## ■ Advanced options



### **System Restore**

Use a restore point recorded on your PC to restore Windows.



### **System Image Recovery**

Recover Windows using a specific system image file.



### **Startup Repair**

Fix problems that keep Windows from loading.



### **Command Prompt**

Use the Command Prompt for advanced troubleshooting.



### **UEFI Firmware Settings**

Change settings in your PC's UEFI firmware.



### **Startup Settings**

Change Windows Startup behavior.

## Appendix

### ■ **Warranty & Service:**

Warranty and service and related information please refer to the warranty card or GIGABYTE service website as the below link:

<http://www.gigabyte.com/support-downloads/technical-support.aspx>

### ■ **FAQ:**

FAQ (Frequent Asked Questions) please refer to the below link:

<http://www.gigabyte.com/support-downloads/faq.aspx>