

GIGABYTE™

P17 **USER'S MANUAL**
使 用 手 冊

English

Congratulations on your purchase of the GIGABYTE Notebook.

This manual will help you to get started with setting up your notebook. The final product configuration depends on the model at the point of your purchase. GIGABYTE reserves the right to amend without prior notice. For more detailed information, please visit our website at www.gigabyte.com.

Using GIGABYTE Notebook for the First Time

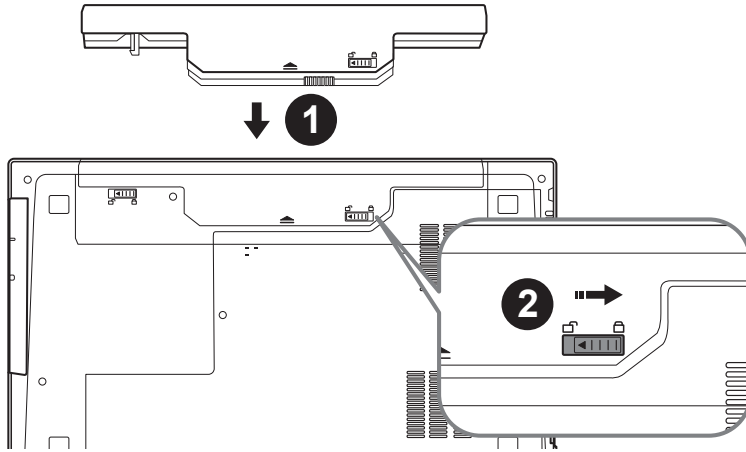

To install the battery please follow these steps:

- 1 Insert the battery pack into the compartment.
- 2 Remember to slide the switch to the "Lock" position.

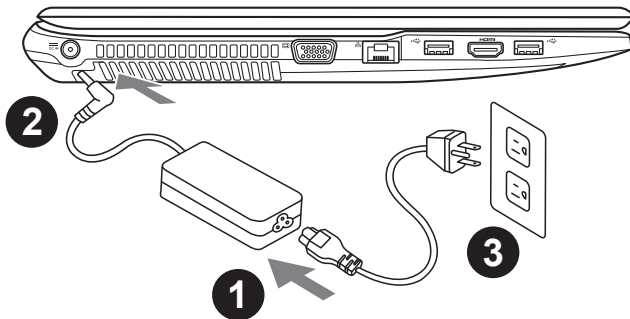

- 1 Connect the the power cord to the AC adapter.
- 2 Connect the AC adapter to the DC-in jack on the left side of the notebook.
- 3 Connect the power cord to the power outlet.

! IMPORTANT

- Ensure that your Notebook PC is connected to a grounded power adapter before turning it on for the first time.
- When using your Notebook PC on power adapter mode, the socket outlet must be near to the unit and easily accessible.
- Locate the input/output rating label on your Notebook PC and ensure that it matches the input/output rating information on your power adapter. Some Notebook PC models may have multiple rating output currents based on the available SKU.
- Power adapter information: Input voltage: 100-240Vac, - Input frequency: 50-60Hz, - Rating output voltage: 19.5V

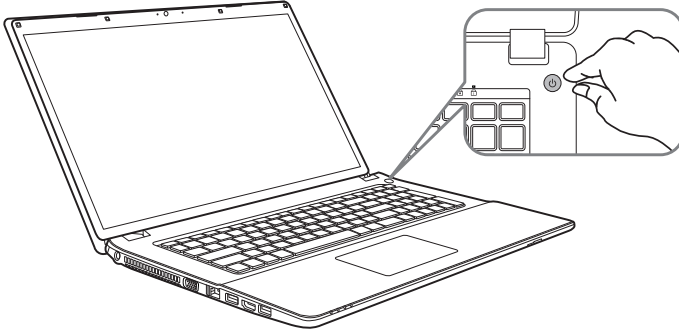

Switching on the Power

After you turn on the P17 for the very first time, do not turn it off until the operating system has been configured. Please note that the volume for the audio will not function until Windows® Setup has completed.

Booting Up the P17 for the First Time

Depending on your configuration, the Microsoft® Windows® Boot Screen will be the first screen that you will see as the notebook starts up. Follow the on-screen prompts and instructions and enter your personal information to complete the setup of the Windows® Operating System.

Your GIGABYTE Notebook Tour

Top View

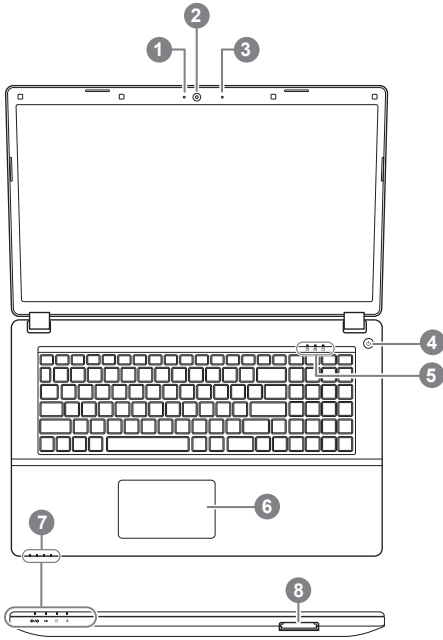

- 1 Webcam on/off Indicator
- 2 Webcam
- 3 Built-In Mic
- 4 Power Button
- 5 LED Indicators ①
 - ① Number Lock Activated
 - Caps Lock Activated
 - Scroll Lock Activated
- 6 Touchpad and buttons
- 7 LED Indicators ②
 - ② power on/Suspend Status LED
 - Battery Status LED
 - HDD Status LED
 - Airplane Mode Status LED
- 8 Flash Memory Card Reader

Left View

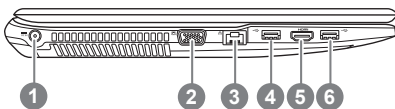

- 1 Power DC input
- 2 D-Sub
- 3 LAN RJ 45
- 4 USB Port 3.0
- 5 HDMI
- 6 USB Port 3.0

Right View

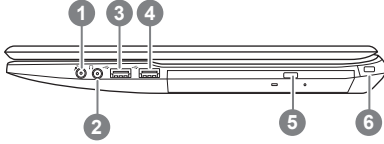

- 1 Microphone input Jack
- 2 Headphone output Jack
- 3 USB Port 2.0
- 4 USB Port 3.0
- 5 Optical Drive
- 6 Kensington Lock Port



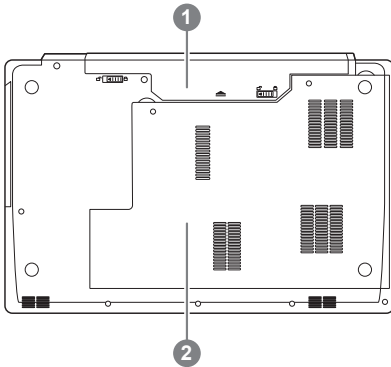



Bottom View



- 1 Battery
- 2 HDD & Memory Compartment

Hotkeys

The computer employs hotkeys or key combinations to access most of the computer's controls like screen brightness and volume output. To activate hotkeys, press and hold the <Fn> key before pressing the other key in the hotkey combination.

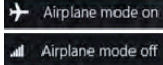
Hotkey	Description	Icon
Fn+Esc	Control Center Toggle (see over)	
Fn+1	Fan Control Toggle - Automatic Fan Control / Full Power	
Fn+~	Play/ Pause(in Audio/Video Programs)	
Fn+F1	Touchpad Toggle	
Fn+F2	Turn LCD Backlight OFF (Press a key to or use Touchpad to turn on)	
Fn+F3	Mute Toggle	
Fn+F5/F6	Volume Decrease/Increases	
Fn+F7	Display Toggle	
Fn+F8/F9	Bright Decreases/Increases	
Fn+F10	PC Camera Power on and off	
Fn+F11	Airplane Mode Toggle	
Fn+F12	Sleep Toggle	

P17 Caddy bay instruction

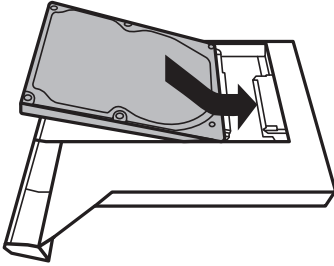
1

- Install the HDD into Caddy bay.

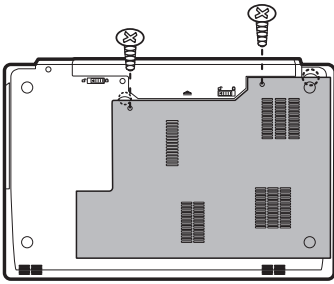
2

- Unplug two screws and open the back cover.

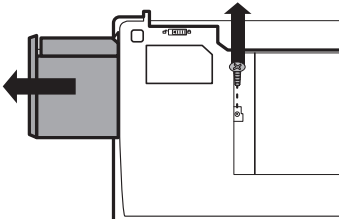
3

- Unplug one screw and take out the ODD bay.

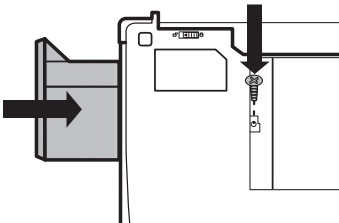
4

- Install the Caddy bay in notebook and lock the screws.

System Recovery (Restore your laptop operating system)

When something is going wrong with the laptop operating system, the storage of the laptop has a hidden partition containing a full back up image of the operating system that can be used to restore the system to factory default settings.



Note

- If the storage has been switched or the partition deleted, the recovery option will no longer be available and a recovery service will be needed.
- The recovery function is only available on devices with O/S preinstalled. Devices with DOS do not have the recovery function.

Launch System Recovery

The system recovery feature is preinstalled before the laptop is shipped from the factory. The option menu allows you to launch the Windows recovery tool to reinstall the operating system to factory default.

The brief introduction below will show you how to start the recovery tool and restore your system.



All ready to go

Make sure your PC is plugged in. This will take a few minutes.

Windows 7 Recovery Guide

1

Turn off and restart the laptop.

2



During the laptop turn on process, press and hold F9 key to launch the tool.

3



The recovery will be activated and you will see the option buttons on the window. Click on “Recovery” to start it.



Caution

Once the “Recovery” is selected, your personal data and files will be deleted after the laptop starts restoring, and the operating system will be reset to factory default settings.

4

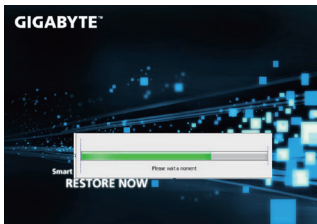

A progress indicator bar will show on the window when the recovery process is running. Please make sure the AC-adaptor is plugged in and do not turn off the laptop.

5



Reboot the laptop after the system recovery is complete.

Windows 10 Recovery Guide

1

Turn off and restart the laptop.

2



During the laptop turn on process, press and hold F9 key to launch the tool.

3



Choose "Troubleshoot" to enter the recovery settings. (Also you can choose "Continue" to exit recovery system and continue to Windows 10 for files or data backup.)



There are two options for system recovery

- **Reset this PC**

You can choose to keep or remove your files and then reinstalls Windows without losing your files.

- **GIGABYTE Smart Recovery**

Your PC settings will be restored to factory default settings.

Caution: All personal data and files will be lost.

4



■ Choose "Reset this PC"

► Keep my files

Choose an account to continue. All apps will be removed, and settings will back to pure O/S (without GIGABYTE app), but your personal files will be kept.

► Remove everything

All apps, setting and personal files will be removed.

⇒ Just remove my files

Only personal data and files will be removed, but computer settings will be kept.

⇒ Fully clean the drive

The drive will be completely restored to factory default settings. It takes more time. > [Click on "Reset" to execute recovery function.]



Here are what will happen

- All of your personal files and apps will be removed.
- Your PC settings will be restored to pure O/S (without GIGABYTE app) .



■ GIGABYTE Smart Recovery



The recovery will be activated and you will see the option buttons on the window. Click on “Yes” to start it.



Caution

- Once the “Recovery” is selected, your personal data and files will be deleted after the laptop starts restoring, and the operating system will be reset to factory default settings.
- A progress indicator bar will show on the window when the recovery process is running. Please make sure the AC-adapter is plugged in and do not turn off the laptop.

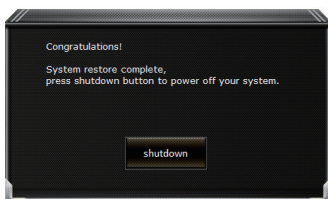

After the system recovery is completed, you will see the option button on the window, please click on “Shutdown”.



■ Advanced options



System Restore

Use a restore point recorded on your PC to restore Windows.



System Image Recovery

Recover Windows using a specific system image file.



Startup Repair

Fix problems that keep Windows from loading.



Command Prompt

Use the Command Prompt for advanced troubleshooting.



UEFI Firmware Settings

Change settings in your PC's UEFI firmware.



Startup Settings

Change Windows Startup behavior.

■ **Warranty & Service:**

Warranty and service and related information please refer to the warranty card or GIGABYTE service website as the below link:

<http://www.gigabyte.com/support-downloads/technical-support.aspx>

■ **FAQ:**

FAQ (Frequent Asked Questions) please refer to the below link:

<http://www.gigabyte.com/support-downloads/faq.aspx>