

GA-7VCSV-RH
Dual Xeon Processor Motherboard

USER'S MANUAL

Xeon™ Processor Motherboard
Rev. 1002

Table of Content

Item Checklist	4
WARNING!	4
Chapter 1 Introduction	5
1.1 Features Summary	5
1.2 GA-7VCSV-RH Motherboard Components	8
Chapter 2 Hardware Installation Process	10
2-1: Installing Processor and CPU Heat Sink	10
Step 2-1-1: Installing CPU	10
Step 2-1-2: Installing Heat Sink	11
2-2: Install memory modules	12
2-3: Install expansion cards	14
2-4: Connect ribbon cables, cabinet wires, and power supply	15
2-4-1 : I/O Back Panel Introduction	15
2-4-2 :Connectors & Jumper Setting Introduction	17
Chapter 3 BIOS Setup	26
Main	28
Advanced Processor Options	31
Advanced	33
Memory Configuration	34
PCI Configuration	36
I/O Device Configuration	38
Advanced Chipset Control	42
Hardware Monitor	44
Security	47
Server	49
System Management	50
Console Redirection	51
Boot	54
Exit	56

Chapter 4 Technical Reference	62
Block Diagram	62
Chapter 5 Driver Installation	63
A. Intel Chipset Software Installation Utilities	63
B. Broadcom LAN Driver Installation	65
C. Intel RAID Driver Installation	67
D. XGI VGA Driver Installation	68
E. Matrix Storgae Manager Utility Installation	69
F. DirectX 9.0C Driver Installation	71
Chapter 6 Appendix	72
Acronyms	72

Item Checklist

- | | |
|---|--|
| <input checked="" type="checkbox"/> The GA-7VCSV-RH motherboard | <input checked="" type="checkbox"/> Serial ATA cable x 6 |
| <input checked="" type="checkbox"/> IDE (ATA100) cable x 1 / Floppy cable x 1 | <input checked="" type="checkbox"/> Serial ATA power cable x 6 |
| <input checked="" type="checkbox"/> CD for motherboard driver & utility | <input checked="" type="checkbox"/> I/O Shield Kit |
| <input checked="" type="checkbox"/> GA-7VCSV-RH user's manual | |



WARNING!

Computer motherboards and expansion cards contain very delicate Integrated Circuit (IC) chips. To protect them against damage from static electricity, you should follow some precautions whenever you work on your computer.

1. Unplug your computer when working on the inside.
2. Use a grounded wrist strap before handling computer components. If you do not have one, touch both of your hands to a safely grounded object or to a metal object, such as the power supply case.
3. Hold components by the edges and try not touch the IC chips, leads or connectors, or other components.
4. Place components on a grounded antistatic pad or on the bag that came with the components whenever the components are separated from the system.
5. Ensure that the ATX power supply is switched off before you plug in or remove the ATX power connector on the motherboard.

Installing the motherboard to the chassis...

If the motherboard has mounting holes, but they don't line up with the holes on the base and there are no slots to attach the spacers, do not become alarmed you can still attach the spacers to the mounting holes. Just cut the bottom portion of the spacers (the spacer may be a little hard to cut off, so be careful of your hands). In this way you can still attach the motherboard to the base without worrying about short circuits. Sometimes you may need to use the plastic springs to isolate the screw from the motherboard PCB surface, because the circuit wire may be near by the hole. Be careful, don't let the screw contact any printed circuit write or parts on the PCB that are near the fixing hole, otherwise it may damage the board or cause board malfunctioning.

Chapter 1 Introduction

1.1 Features Summary

Form Factor	<ul style="list-style-type: none"> • 12" x 10.5" CEB size form factor, 6 layers PCB
CPU	<ul style="list-style-type: none"> • Supports Dual Intel® Xeon™ processors • Xeon™ Dual Core in LGA 771 socket • Supports 667/1066MHz FSB (Dempsey) • Supports 1066/1333MHz FSB (Woodcrest) • L2 cache on-die per processor from 4M
Chipset	<ul style="list-style-type: none"> • Intel® 5000V Chipset • Intel® 6321ESB
Memory	<ul style="list-style-type: none"> • 4 x 240-pin Fully Buffered DIMM sockets • Supports up to 16GB FBD 533/667 memory • Dual Channel memory bus • Fully Buffered DIMM (FBD) 533/667MHz • Support 512MB, 1GB, 2GB, and 4GB memory • Single-bit Errors Correction, Multiple-bit Errors Detection
I/O Control	<ul style="list-style-type: none"> • ITE IT8718 Super I/O
Expansion Slots	<ul style="list-style-type: none"> • Supports 1 PCI slots 32-Bit/33MHz (5V) • Supports 2 PCI-X slots 64-Bit/100~133MHz • Supports 1 PCI-E x1 (in x4 slot) • Supports 1 PCI-E x4 (in x8 slot) • Supports 1 PCI-E x8 slot
SATA RAID Controller	<ul style="list-style-type: none"> • Intel® 6321ESB built in SATA RAID 0,1,5, 10 (Windows Only) • Supports 6 SATA/SATAII devices
On-Board Peripherals	<ul style="list-style-type: none"> • 1 ATA100 connector • 1 Floppy port supports 720K, 1.44M and 2.88M bytes. • 2 PS/2 connectors • 2 Serial port (COM; 1 by cable) • 8 x USB 2.0 (4 by cable) • 1 VGA connector • 2 x LAN RJ45 • 6 x SATAII connectors

GA-7VCSV-RH Motherboard

On-Board Graphic	<ul style="list-style-type: none">• XGI Volari Z7 with 16MB DDR SDRAM
On-Board LAN	<ul style="list-style-type: none">• Dual Broadcom® 5789 Gigabit Ethernet controllers
Hardware Monitor	<ul style="list-style-type: none">• Winbond 83792G controller• Enhanced features with CPU Vcore, VCC3 (3.3V), VCC5V, VBAT3V, CPU Motherboard Temperature• System Voltage Detect• CPU/System Fan Revolution Detect• CPU shutdown when overheat
BIOS	<ul style="list-style-type: none">• Phoenix BIOS on 8Mb flash ROM
Additional Features	<ul style="list-style-type: none">• PS/2 Mouse wake up from S1 under Windows Operating System• COM Port wake up• Supports S1, S4, S5 under Windows Operating System• Wake on LAN (WOL)• AC Recovery• Supports Console Redirection• Supports 4-pin Fan controller

1.2 GA-7VCSV-RH Motherboard Components

- | | | | |
|-----|-------------------------|-----|--------------------------------|
| 1. | Primary CPU | 26. | PCI-Slot1 (PCI-E x8 Slot) |
| 2. | Secondary CPU | 27. | PCI-Slot2 (PCI-X 64bit/100MHz) |
| 3. | Intel 5000V | 28. | PCI-Slot3 (PCI-X 64bit/100MHz) |
| 4. | Intel 6321ESB | 29. | PCI-Slot4 (PCI-E x8 Slot) |
| 5. | Broadcome 5789 GbE | 30. | PCI-Slot5 (PCI-E x4 Slot) |
| 6. | ITE 8718 | 31. | PCI-Slot6 (PCI 32bit/33MHz) |
| 7. | Vedio RAM | 32. | RJ45 LAN/USB ports |
| 8. | XGI Volari Z7 | 33. | RJ45 LAN/USB ports |
| 9. | Winbond W83792G | 34. | VGA Port |
| 10. | BIOS Flash | 35. | COM Port |
| 11. | IDE Connector | 36. | PS/2 Connectors |
| 12. | Floppy Connector | 37. | FBD DIMMs1~4 |
| 13. | Front USB1 Connector | 38. | CPU1 Fan |
| 14. | Front USB2 Connector | 39. | CPU2 Fan |
| 15. | COM2 Connector | 40. | System Fan1 |
| 16. | Front Panel Connector | 41. | System Fan2 |
| 17. | SATA1 Connector | 42. | System Fan3 |
| 18. | SATA2 Connector | 43. | System Fan4 |
| 19. | SATA3 Connector | 44. | Jumper block |
| 20. | SATA4 Connector | 45. | Jumper block |
| 21. | SATA5 Connector | 46. | Jumper block |
| 22. | SATA6 Connector | 47. | Chassis intrusion connector |
| 23. | Auxiliary Power (ATX1) | | |
| 24. | Auxiliary Power (ATX 3) | | |
| 25. | Battery | | |

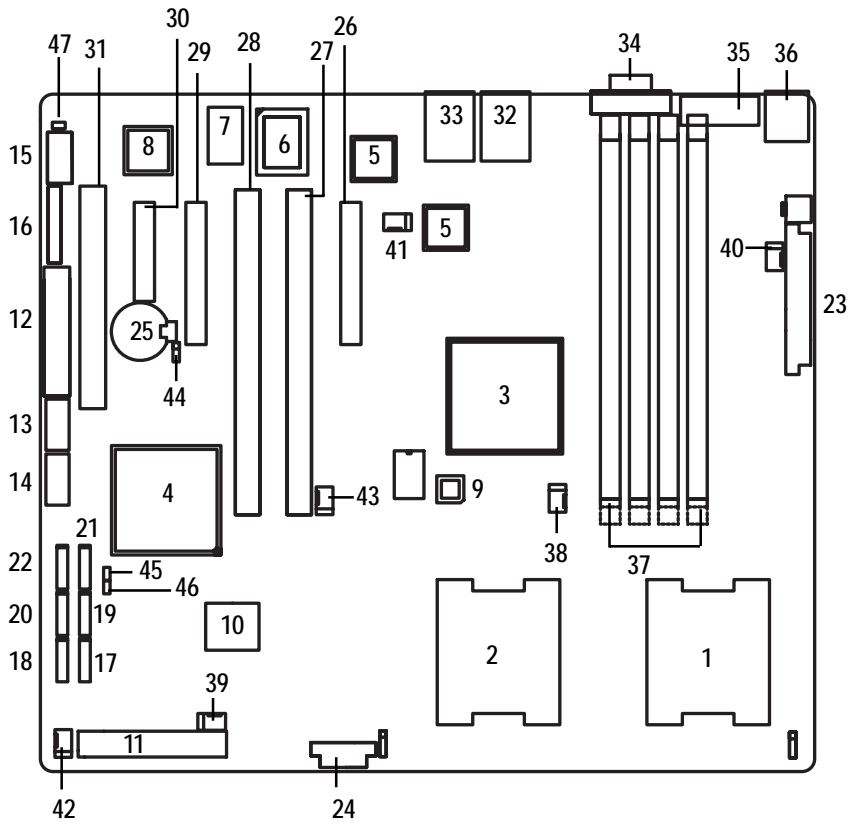

Chapter 2 Hardware Installation Process

2-1: Installing Processor and CPU Heat Sink



CAUTION

Before installing the processor and cooling fan, adhere to the following cautions:

1. The processor will overheat without the heatsink and/or fan, resulting in permanent irreparable damage.
2. Never force the processor into the socket.
3. Apply thermal grease on the processor before placing cooling fan.
4. Please make sure the CPU type is supported by the motherboard.
5. If you do not match the CPU socket Pin 1 and CPU cut edge well, it will cause improper installation. Please change the insert orientation.

Step 2-1-1: Installing CPU

- Step 1 Raise the metal locking lever on the socket.
- Step 2 Remove the plastic covering on the CPU socket.
- Step 3 Insert the CPU with the correct orientation. The CPU only fits in one orientation.
- Step 4 Once the CPU is properly placed, please replace the plastic covering and push the metal lever back into locked position.



Step 2-1-2: Installing Heat Sink



Step 1.
Please apply heatsink paste on the surface of the installed CPU.

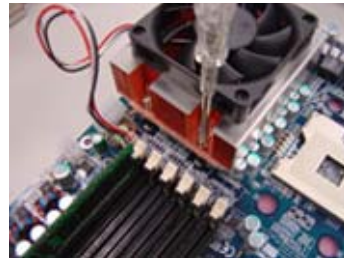

Step 2.
Secure the heatsink supporting-base onto the CPU socket on the mainboard.



Step 3.
Attach the power connector of the heatsink to the CPU fan header located on the motherboard.

2-2: Install memory modules

GA-7VCSV-RH has 4 dual inline memory module (DIMM) sockets. It supports the Dual Channel Technology. The BIOS will automatically detects memory type and size during system boot. For detail DIMM installation, please refer to the following instructions.

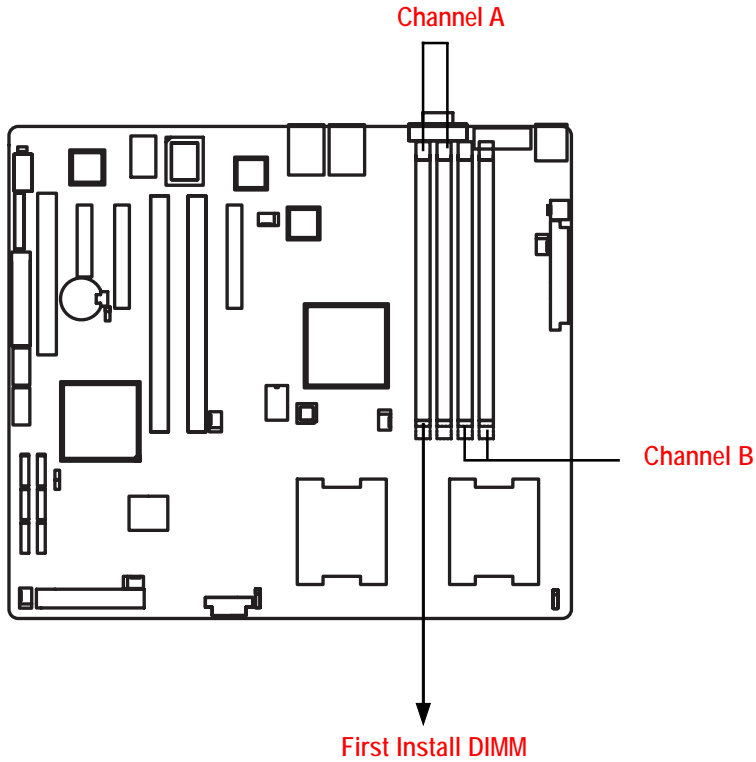

Installation Steps:

1. Unlock a DIMM socket by pressing the retaining clips outwards.
2. Align a DIMM on the socket such that the notch on the DIMM exactly matches the notches in the socket.

Please note that DIMM must be populated in order starting at the farthest slot from the ATX power.

3. Firmly insert the DIMM into the socket until the retaining clips snap back in place.
4. When installing the DIMM into the DIMM socket, we recommend to populate one DIMM in Channel A module and one in Channel B module for best performance.

Please note that each logical DIMM must be made of two identical DIMMs having the same device size on each and the same DIMM size.

5. Reverse the installation steps when you want to remove the DIMM module.

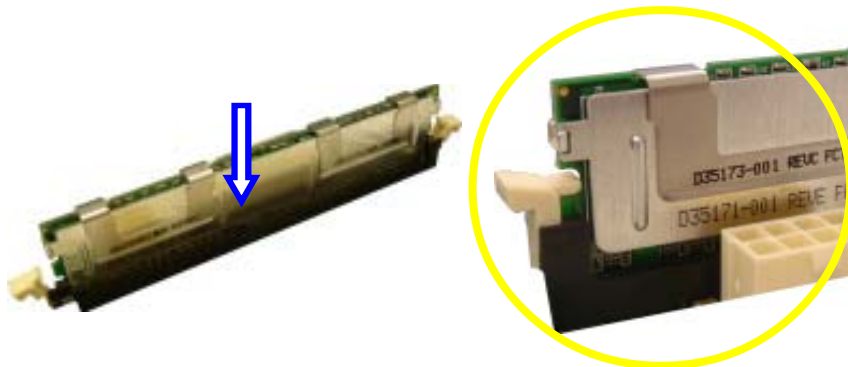

Locked Retaining Clip

2-3: Install expansion cards

1. Read the related expansion card's instruction document before install the expansion card into the computer.
2. Remove your server's chassis cover, necessary screws and slot bracket from the computer.
3. Press the expansion card firmly into expansion slot in motherboard.
4. Be sure the metal contacts on the card are indeed seated in the slot.
5. Replace the screw to secure the slot bracket of the expansion card.
6. Replace your computer's chassis cover.
7. Power on the computer, if necessary, setup BIOS utility of expansion card from BIOS.
8. Install related driver from the operating system.



2-4: Connect ribbon cables, cabinet wires, and power supply

2-4-1 : I/O Back Panel Introduction

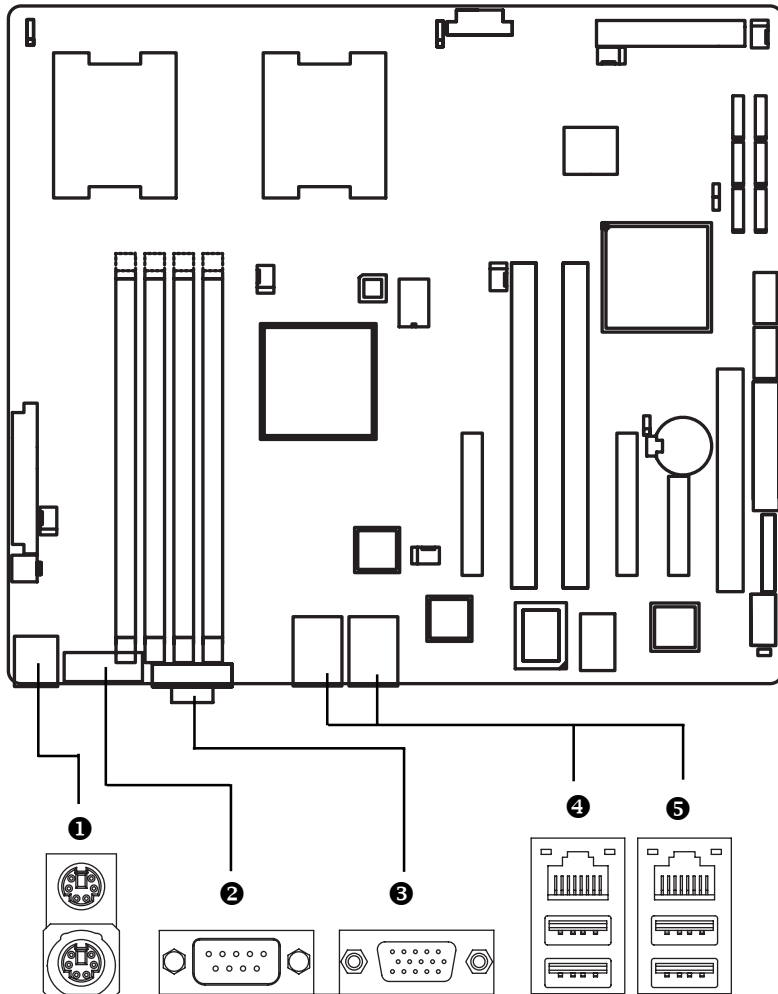

❶ PS/2 Keyboard and PS/2 Mouse Connector

To install a PS/2 port keyboard and mouse, plug the mouse to the upper port (green) and the keyboard to the lower port (purple).

❷/❸ Serial Port / VGA Port

This connector supports 1 standard COM port and 1 VGA port; mouse and modem etc can be connected to Serial port.

❹/❺ LAN Port / USB

Before you connect your device(s) into USB connector(s), please make sure your device(s) such as USB keyboard, mouse, scanner, zip, speaker...etc. have a standard USB interface. Also make sure your OS supports USB controller. If your OS does not support USB controller, please contact OS vendor for possible patch or driver updated. For more information please contact your OS or device(s) vendors.

LAN LED Description



Name	Color	Condition	Description
LAN Link/Activity	Green	ON	LAN Link / no Access
	Green	BLINK	LAN Access
	-	OFF	Idle
10/100 LAN Speed	Green	ON	100Mbps connection
	-	OFF	10Mbps connection
GbE LAN Speed	Yellow	ON	1Gbps connection
	Green	ON	100Mbps connection
	-	OFF	10Mbps connection

2-4-2 :Connectors & Jumper Setting Introduction

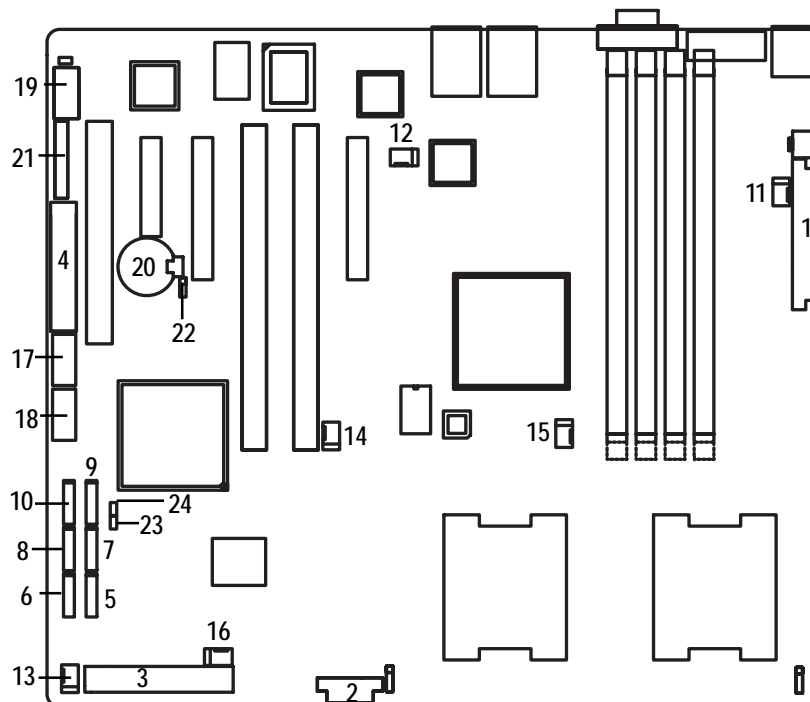

- | | |
|-------------------------------------|-------------------------------------|
| 1. ATX2 | 15. CPU_FAN1 (CPU 1 Fan Connector) |
| 2. ATX3 | 16. CPU_FAN2 (CPU 1 Fan Connector) |
| 3. IDE1 (IDE Connector) | 17. F_USB1 (Front USB Connector) |
| 4. FDD1 (Floppy Connector) | 18. F_USB2 (Front USB Connector) |
| 5. SATA 1 (SATA Connector) | 19. COM2 |
| 6. SATA 2 (SATA Connector) | 20. Battery |
| 7. SATA 3 (SATA Connector) | 21. F_Panel (Front Panel Connector) |
| 8. SATA 4 (SATA Connector) | 22. JP6 (Clear CMOS Jumper) |
| 9. SATA 5 (SATA Connector) | 23. JP10 (Password disable Jumper) |
| 10. SATA 6 (SATA Connector) | 24. JP_REC (BIOS Recovery Jumper) |
| 11. SYS_FAN1 (System Fan Connector) | |
| 12. SYS_FAN2 (System Fan Connector) | |
| 13. SYS_FAN3 (System Fan Connector) | |
| 14. SYS_FAN4 (System Fan Connector) | |

1) ATX2 (Auxukiary Power Connector)

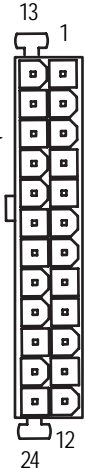
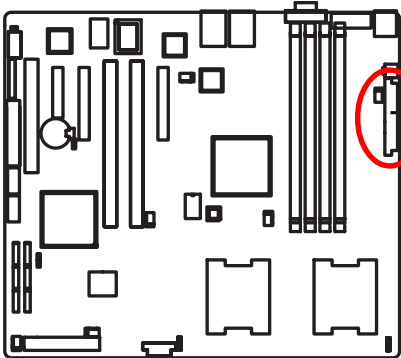

PIN No.	Definition
1	+3.3V
2	+3.3V
3	GND
4	+5V
5	GND
6	+5V
7	GND
8	POK
9	5VSB
10	+12V
11	+12V
12	+3.3V
13	+3.3V
14	-12V
15	GND
16	PSON
17	GND
18	GND
19	GND
20	NC
21	+5V
22	+5V
23	+5V
24	GND

➤ AC power cord should only be connected to your power supply unit after ATX power cable and other related devices are firmly connected to the mainboard.

2) ATX3 (Auxukiary +12V Power Connector)

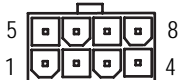
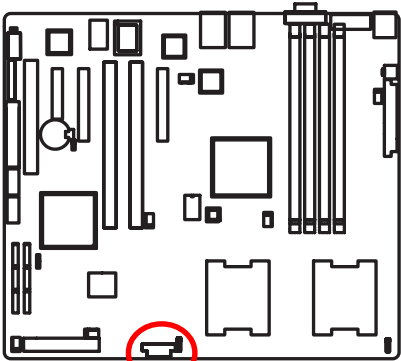

Pin No.	Definition
1	GND
2	GND
3	GND
4	GND
5	P12V_CPU
6	P12V_CPU
7	P12V_CPU
8	P12V_CPU

➤ This connector (ATX +12V) is used only for CPU Core Voltage.

3) IDE1 (IDE Connector)

Please connect first harddisk to IDE1. The red stripe of the ribbon cable must be the same side with the Pin1.

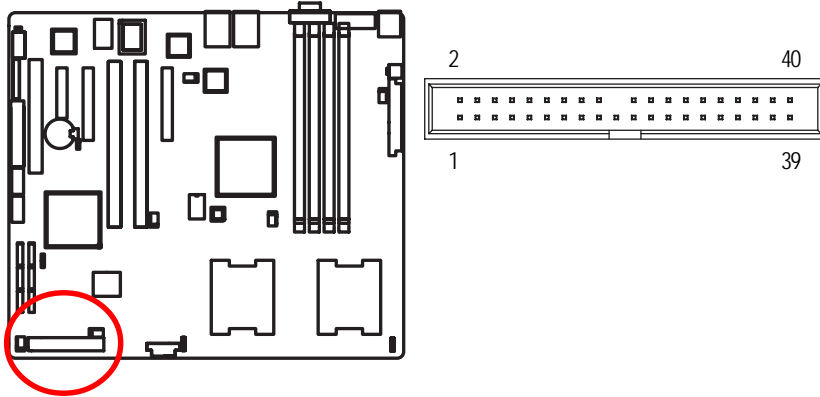

4) FDD1 (Floppy Connector)

Please connect the floppy drive ribbon cables to FDD. It supports 720K, 1.44M and 2.88Mbytes floppy disk types. The red stripe of the ribbon cable must be the same side with the Pin1.

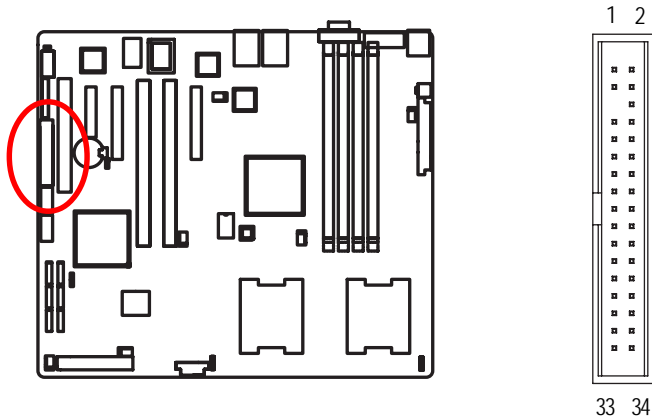

5/ 6/ 7/ 8/ 9/ 10) SATA 1~6 (Serial ATA Connectors)

You can connect the Serial ATA device to this connector, it provides you high speed transfer rates (150MB/sec).

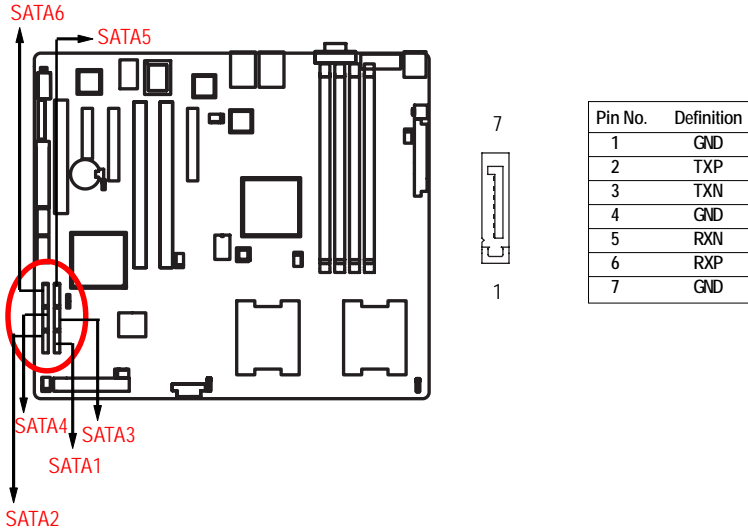

11/ 12/ 13/ 14) SYS_FAN 1/2/3/4 (System Fan Connectors)

This connector allows you to link with the cooling fan on the system case to lower the system temperature. These connectors are for system use only.

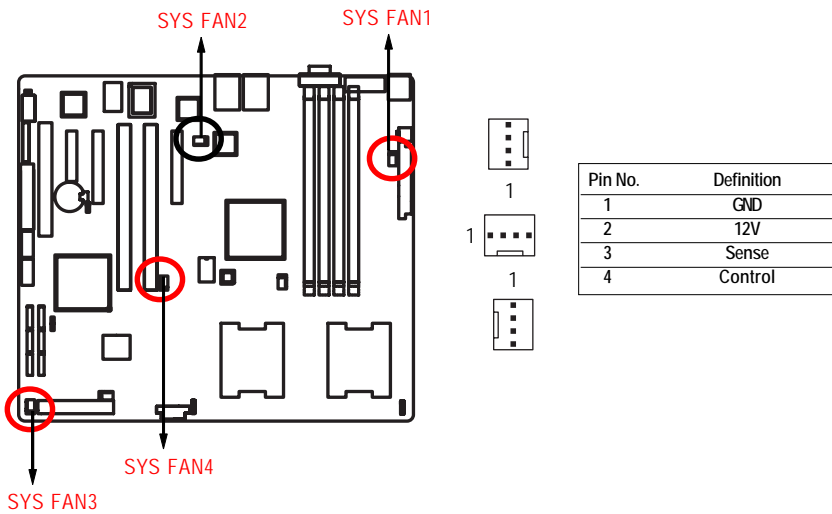

15/ 16) CPU1/2_FAN (CPU Fan Connectors)

Please note, a proper installation of the CPU cooler is essential to prevent the CPU from running under abnormal condition or damaged by overheating. The CPU fan connector supports Max. current up to 1A .

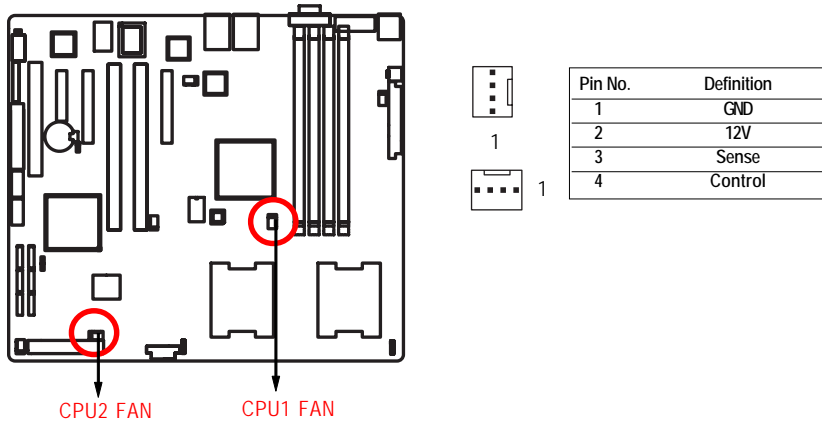

17/ 18) F_USB1/2 (Front USB Connectors)

Be careful with the polarity of the front USB connector. Check the pin assignment carefully while you connect the front USB cable, incorrect connection between the cable and connector will make the device unable to work or even damage it. For optional front USB cable, please contact your local dealer.

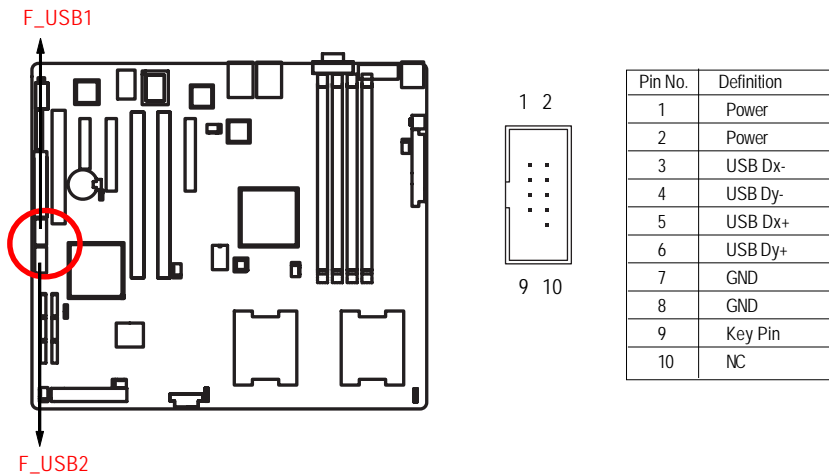

19) COM2

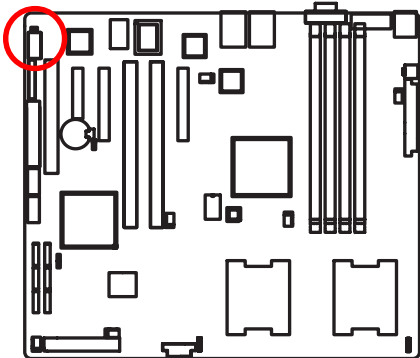

Pin No.	Definition
1	DCD-
2	SIN2
3	SOUT2
4	DTR2-
5	GND
6	DSR2-
7	RTS2-
8	CTS2-
9	RI2-
10	Key Pin

20) Battery

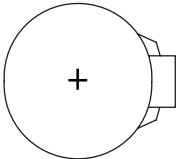
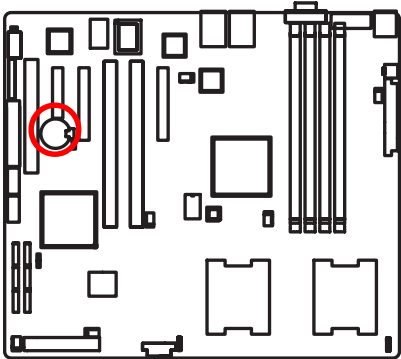

CAUTION

- ❖ Danger of explosion if battery is incorrectly replaced.
- ❖ Replace only with the same or equivalent type recommended by the manufacturer.
- ❖ Dispose of used batteries according to the manufacturer's instructions.

If you want to erase CMOS...

1. Turn OFF the computer and unplug the power cord.
2. Remove the battery, wait for 30 second.
3. Re-install the battery.
4. Plug the power cord and turn ON the computer.

21) F_Panel (2X12 Pins Front Panel connector)

Please connect the power LED, PC speaker, reset switch and power switch of your chassis front panel to the F_PANEL connector according to the pin assignment above.

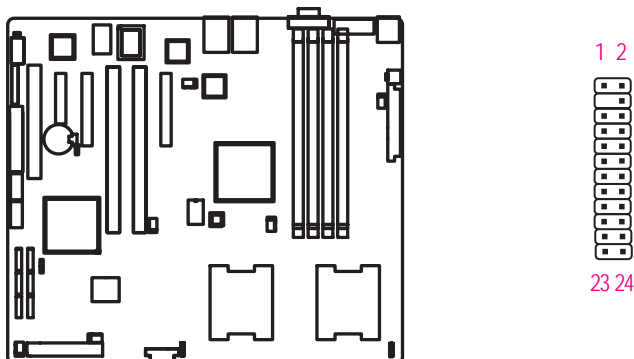

Pin No.	Signal Name	Description
1.	PWLED+	Power LED Signal anode (+)
2.	5VSB	P5VStand By Power
3.	KEY	Pin Removed
4.	Reserved	Reserved
5.	PWLED-	Power LED Signal cathode(-)
6.	Reserved	Reserved
7.	HD+	Hard Disk LED Signal anode (+)
8.	Reserved	Reserved
9.	HD-	Hard Disk LED Signal cathode(-)
10.	Reserved	Reserved
11.	PWB+	Power Button Signal anode (+)
12.	L1_ACT	LAN1 access LED Signal
13.	PWB+_GND	Power Button Ground
14.	L1_LNK-	LAN1 linked LED Signal cathode(-)
15.	RST_BTN-	Reset Button cathode(-)
16.	SENSOR_SDA	SMBus Data
17.	RST_BTN_GND	Reset Button Ground
18.	SENSOR_SCL	SMBus Clock
19.	Reserved	Reserved
20.	CASE_OPEN-	Chassis intrusion Signal (Optional)
21.	GND	Ground
22.	L2_ACT	LAN2 access LED Signal
23.	NMI_SW-	NMI Switch cathode(-)
24.	L2_LNK-	LAN2 linked LED Signal cathode(-)

22) JP6 (Clear CMOS Function)

You may clear the CMOS data to its default values by this jumper.

Default value doesn't include the "Shunter" to prevent from improper use this jumper. To clear CMOS, temporarily short 2-3 pin.

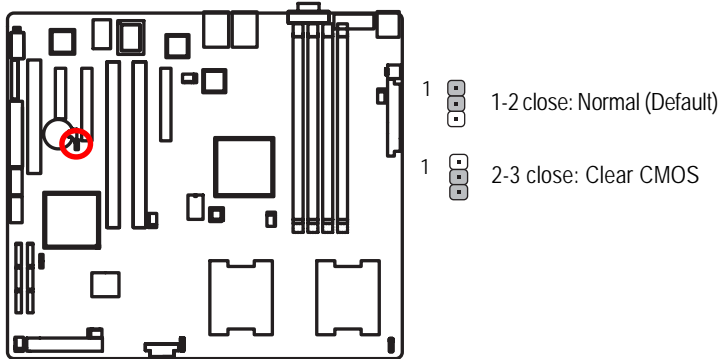

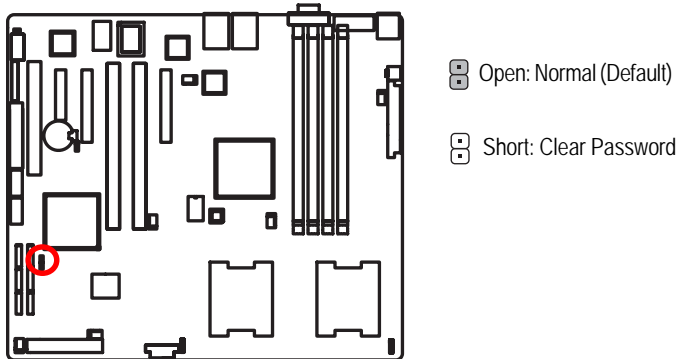

23) JP10 (Password Disable Function)

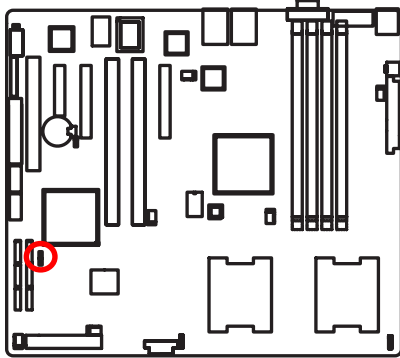

Please remove the jumper when system reboot next time.

25) RECOVERY (BIOS Recovery Function)



-  Open: Disable this function. (Default)
-  Short: Enable BIOS Recovery function



Please short the jumper when system access recovery floppy disk.

Chapter 3 BIOS Setup

BIOS Setup is an overview of the BIOS Setup Program. The program that allows users to modify the basic system configuration. This type of information is stored in battery-backed CMOS RAM so that it retains the Setup information when the power is turned off.

ENTERING SETUP

Power ON the computer and press <F2> immediately will allow you to enter Setup.

CONTROL KEYS

<↑>	Move to previous item
<↓>	Move to next item
<←>	Move to the item in the left hand
<→>	Move to the item in the right hand
<Esc>	Main Menu - Quit and not save changes into CMOS Status Page Setup Menu and Option Page Setup Menu - Exit current page and return to Main Menu
<+/PgUp>	Increase the numeric value or make changes
<-/PgDn>	Decrease the numeric value or make changes
<F1>	General help, only for Status Page Setup Menu and Option Page Setup Menu
<F2>	Reserved
<F3>	Reserved
<F4>	Reserved
<F6>	Reserved
<F7>	Reserved
<F8>	Reserved
<F9>	Load the Optimized Defaults
<F10>	Save all the CMOS changes, only for Main Menu

GETTINGHELP

Main Menu

The on-line description of the highlighted setup function is displayed at the bottom of the screen.

Status Page Setup Menu / Option Page Setup Menu

Press F1 to pop up a small help window that describes the appropriate keys to use and the possible selections for the highlighted item. To exit the Help Window press <Esc>.

- **Main**
This setup page includes all the items in standard compatible BIOS.
- **Advanced**
This setup page includes all the items of AMI special enhanced features.
(ex: Auto detect fan and temperature status, automatically configure hard disk parameters.)
- **Security**
Change, set, or disable password. It allows you to limit access the system and setup.
- **Server**
Server additional features enabled/disabled setup menus.
- **Boot**
This setup page include all the items of first boot function features.
- **Exit**
There are five options in this selection: Exit Saving Changes, Exit Discarding Changes, Load Optimal Defaults, Load Failsafe Defaults, and Discard Changes.

Main

Once you enter Phoenix BIOS Setup Utility, the Main Menu (Figure 1) will appear on the screen. Use arrow keys to select among the items and press <Enter> to accept or enter the sub-menu.

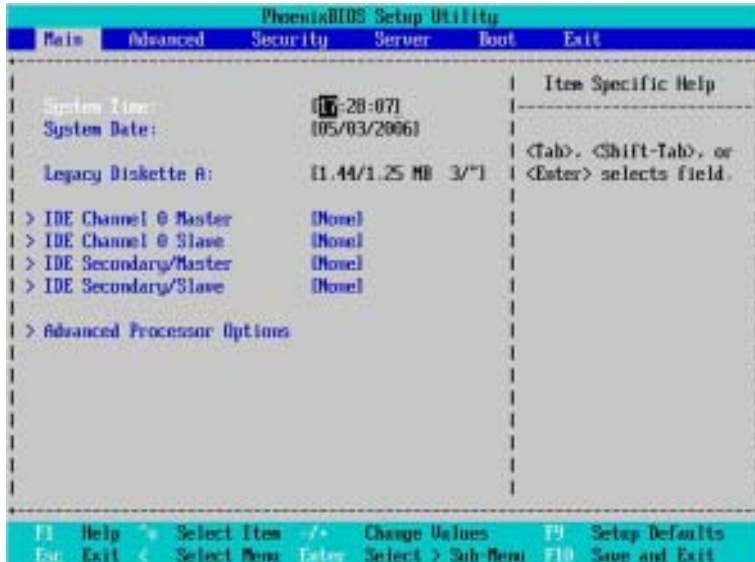

Figure 1: Main

☞ System Time

The time is calculated based on the 24-hour military time clock. Set the System Time (HH:MM:SS)

☞ System Date

Set the System Date. Note that the "Day" automatically changed after you set the date.
(Weekend: DD: MM: YY) (YY: 1099-2099)

☞ Legacy Diskette A

This category identifies the type of floppy disk drive A that has been installed in the computer.

- ▶▶ Disabled Disable this device.
- ▶▶ 720K, 3^{1/2} in. 3^{1/2} inch double-sided drive; 720K byte capacity
- ▶▶ 1.44M, 3^{1/2} in. 3^{1/2} inch double-sided drive; 1.44M byte capacity.
- ▶▶ 2.88M, 3^{1/2} in. 3^{1/2} inch double-sided drive; 2.88M byte capacity.

☞ IDE Primary Master, Slave / Secondary Master, Slave

The category identifies the types of hard disk from drive C to F that has been installed in the computer. There are two types: auto type, and manual type. Manual type is user-definable; Auto type which will automatically detect HDD type.

Note that the specifications of your drive must match with the drive table. The hard disk will not work properly if you enter improper information for this category.

If you select User Type, related information will be asked to enter to the following items. Enter the information directly from the keyboard and press <Enter>. Such information should be provided in the documentation from your hard disk vendor or the system manufacturer.

» **TYPE**

1-39: Predefined types.

Users: Set parameters by User.

Auto: Set parameters automatically. (Default Vaules)

CD-ROM: Use for ATAPI CD-ROM drives or double click [Auto] to set all HDD parameters automatically.

ATAPI Removable: Removable disk drive is installed here.

» **Multi-Sector Transfer**

This field displays the information of Multi-Sector Transfer Mode.

Disabled: The data transfer from and to the device occurs one sector at a time.

Auto: The data transfer from and to the device occurs multiple sectors at a time if the device supports it.

» **LBA Mode**

This field shows if the device type in the specific IDE channel support LBA Mode.

» **32-Bit I/O**

Enable this function to max imize the IDE data transfer rate.

» **Transfer Mode**

This field shows the information of Teansfer Mode.

» **Ultra DMA Mode**

This filed displays the DMA mode of the device in the specific IDE channel.

Advanced Processor Options

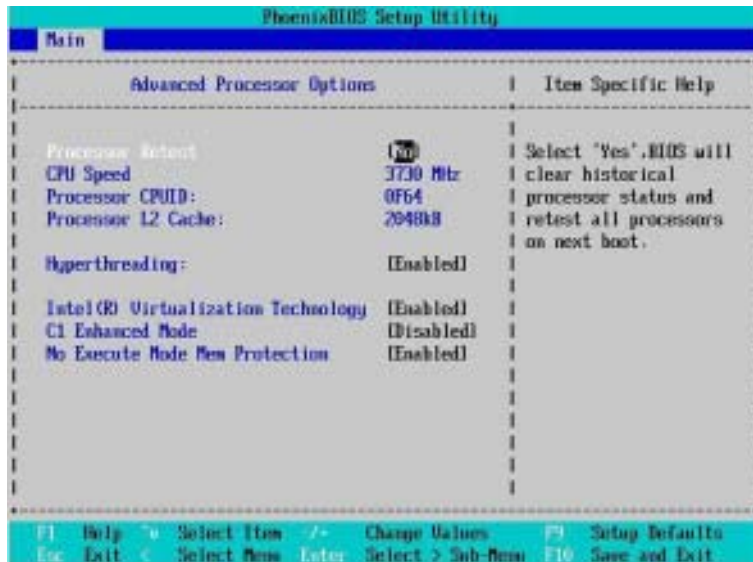

Figure 1-1: Advanced Processor Option

☞ Advanced Processor Option

This category includes the information of CPU Speed, Processor ID, and Processor L2 Cache. And setup menu for Hyperthreading, Numbers of Stop Grant, Intel Virtualizational Technology, No Execute Mode Memory, and Set Max Ext CPUID=3.

☞ Processor Reset

- ▶▶ Yes Select 'Yes' BIOS will clear historical processor status and reset all processors on next boot.
- ▶▶ No Disables Processor Reset function. (Default value)

☞ **Hyper Threading**

- ▶▶ Enabled Enables Hyper-Threading Technology Feature when using Windows XP and Linux 2.4x operating systems that are optimized for Hyper-Threading technology. (Default value)
- ▶▶ Disabled Disables Hyper-Threading Technology when using other operating systems.

☞ **Intel (R) Virtualization Technology**

Intel(R) Virtualization Technology allows a platform to run multiple operating systems and applications in independent partitions. With virtualization, one computer system can function as multiple "virtual" systems. With processor and I/O enhancements to Intel's various platforms, Intel Virtualization Technology can improve the performance and robustness of today's software-only virtual machine solutions.

- ▶▶ Enabled Enabled Intel Virtualization Technology. (Default value)
- ▶▶ Disabled Disables this function.

☞ **C1 Enhanced Mode**

With enabling C1 Enhanced Mode, all loical processors in the physical processor have entered the C1 state, the processor will reduce the core clock frequency to system bus ratio and VID.

- ▶▶ Enabled Enabled C1 Enhanced Mode.
- ▶▶ Disabled Disables C1 Enhanced Mode. (Default value)

☞ **No Execute Mode Mem. Protection**

- ▶▶ Enabled Enable No Execute Mode Memory Protection function. (Default value)
- ▶▶ Disabled Disables No Execute Mode Memory Protection function.

Advanced

About This Section: Advanced

With this section, allowing user to configure your system for basic operation. User can change the processor options, chipset configuration, PCI configuration and chipset control.

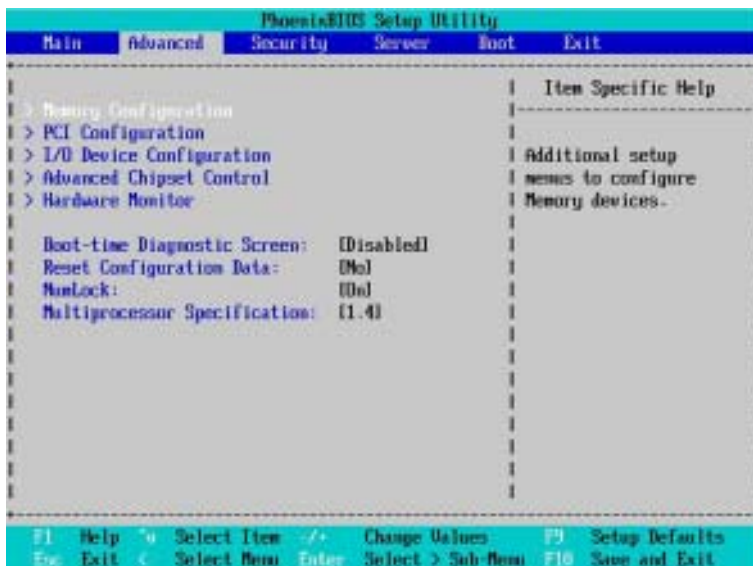

Figure 2: Advanced

Memory Configuration

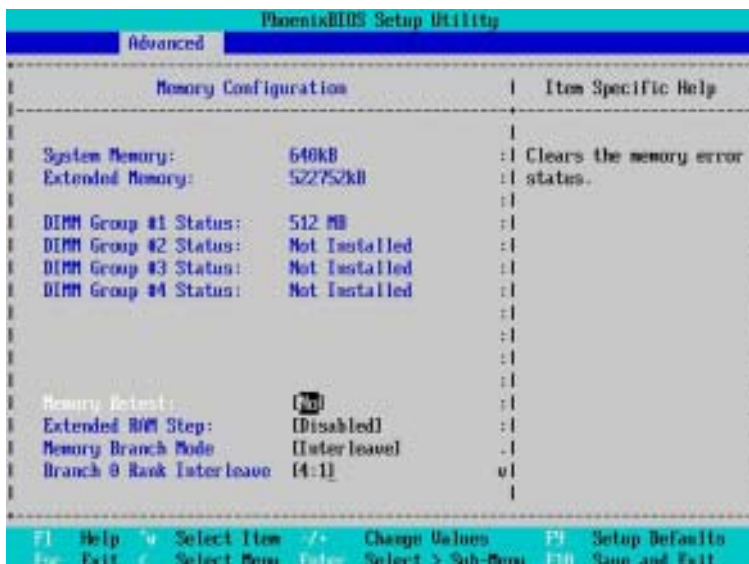

Figure 2-1: Memory Configuration

☞ System Memory/Extended Memory/DIMM Group 1~8 Status

This category is display-only which is determined by POST (Power On Self Test) of the BIOS.

☞ Memory Reset

- ▶▶ Yes Select 'Yes', system will clear the memory error status. Save the changes and restart system. After rebooting system, the Memory Reset item will set to 'No' automatically.
- ▶▶ No Disable this function. (Default value)

☞ Extend RAM Step

- ▶▶ Enabled Enable test extended memory process.
- ▶▶ Disabled Disable this function. (Default value)

☞Memory Branch Mode

- ▶▶Sequential Memory will use sequential mode to save date.
- ▶▶Interleave Memory will use Interleave mode for to distribute every one memory to save date. (Default value)
- ▶▶Mirror Mirror will use backup date by image. Only half of the total memory is report to OS.
- ▶▶Single Channel 0 Disable Default operate Dual channel Mode. Only Single channel 0 will be detect.

☞Branch 0 Rank Sparing

- ▶▶Enabled Enable this item, memory will spare two(dual channel) of all slots.
- ▶▶Disabled Disable this function. (Default value)

PCI Configuration

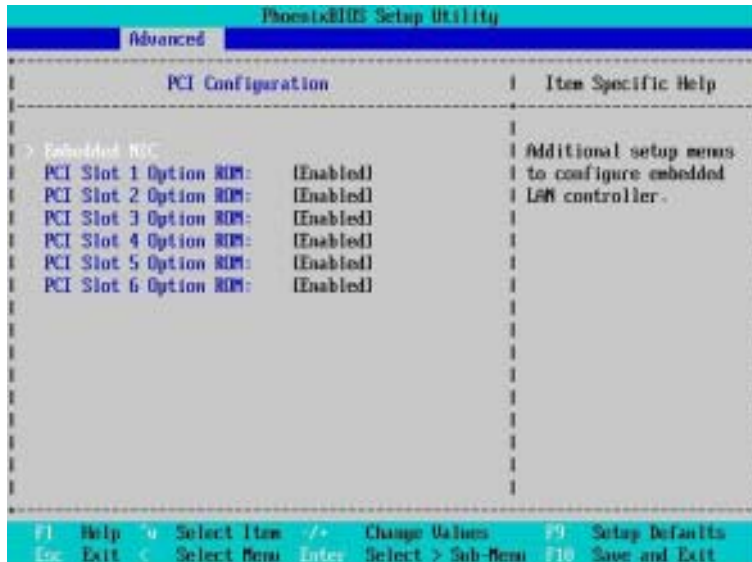

Figure 2-2: PCI Configuration

↳ Embedded NIC

▶ LAN 1 Option ROM Scan

- ▶▶ Enabled Enable onboard LAN1 device and initialize device expansion ROM. (Default value)
- ▶▶ Disabled Disable this function.

▶ LAN2 Option ROM Scan

- ▶▶ Enabled Enable onboard LAN2 device and initialize device expansion ROM. (Default value)
- ▶▶ Disabled Disable this function.

☞ PCI Slot 1/2/3/4/5/6 Option ROM

- ▶▶ Enabled Enableing this item to initialize device expansion ROM.
(Default value)
- ▶▶ Disabled Disable this function.

I/O Device Configuration

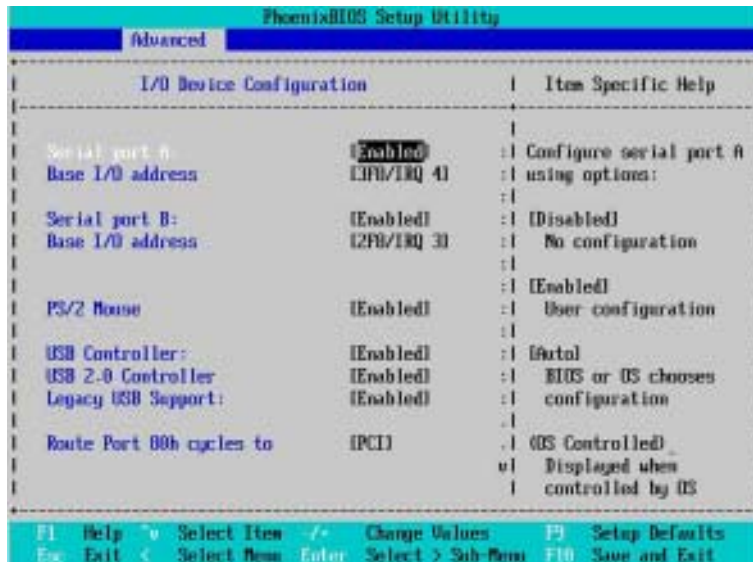

Figure 2-3: I/O Device Configuration

Serial Port A

This allows users to configure serial port A by using this option.

- ▶▶ Enabled Enable the configuration (Default value)
- ▶▶ Disabled Disable the configuration.
- ▶ Base I/O Address/IRQ
 - ▶▶ 3F8/IRQ4 Set IO address to 3F8. (Default value)
 - ▶▶ 2F8/IRQ3 Set IO address to 2F8.
 - ▶▶ 3E8/IRQ4 Set IO address to 3E8.
 - ▶▶ 2E8/IRQ3 Set IO address to 2E8.

Serial Port B

This allows users to configure serial port B by using this option.

- ▶▶ Enabled Enable the configuration
- ▶▶ Disabled Disable the configuration.(Default value)

- ▶ Base I/O Address/IRQ

- ▶▶ 3F8/IRQ4 Set IO address to 3F8.
- ▶▶ 2F8/IRQ3 Set IO address to 2F8. (Default value)
- ▶▶ 3E8/IRQ4 Set IO address to 3E8.
- ▶▶ 2E8/IRQ3 Set IO address to 2E8.

PS/2 Mouse

Set this option 'Enabled' to allow BIOS support for a PS/2 - type mouse.

- ▶▶ Enabled 'Enabled' forces the PS/2 mouse port to be enabled regardless if a mouse is present. (Default value)
- ▶▶ Disabled 'Disabled' prevents any installed PS/2 mouse from functioning, but frees up IRQ12.

USB Controller

This item allows users to enable or disable the USB device by setting item to the desired value.

- ▶▶ Enabled Enable USB controller. (Default value)
- ▶▶ Disabled Disable this function.

PS/2 Mouse

Set this option 'Enabled' to allow BIOS support for a PS/2 - type mouse.

- ▶▶ Enabled 'Enabled' forces the PS/2 mouse port to be enabled regardless if a mouse is present. (Default value)
- ▶▶ Disabled 'Disabled' prevents any installed PS/2 mouse from functioning, but frees up IRQ12.

☞ **USB 2.0 Controller**

This item allows users to enable or disable the USB 2.0 device by setting item to the desired value.

- ▶▶ Enabled Enable USB 2.0 controller. (Default value)
- ▶▶ Disabled Disbale this function.

☞ **Legacy USB Support**

This option allows user to function support for legacy USB.

- ▶▶ Enabled Enables support for legacy USB (Default Value)
- ▶▶ Disabled Disables support for legacy USB.

☞ **Route Port 80h cycles to**

Set route port 80h cycles to either PCI or LPC bus.

- ▶▶ PCI Set Route Port 80h I/O cycles to the PCI bus. (Default Value)
- ▶▶ LPC Set Route Port 80h I/O cycles to the LPC bus.

Parallel ATA

- ▶▶ Enabled Enable Parallel ATA. (Default value)
- ▶▶ Disabled Disable the device.

Serial ATA

- ▶▶ Enabled Enables on-board serial ATA function. (Default Value)
- ▶▶ Disabled Disables on-board serial ATA function.

▶ Native Mode Operation

This option allows user to set the native mode for Serial ATA function.

- ▶▶ Auto Auto detected. (Default value)
- ▶▶ Serial ATA Set Native mode to Serial ATA.

▶ SATA Controller Mode Option

- ▶▶ Compatible Mode SATA and PATA drives are auto-detected and placed in Legacy mode. (Default value)
- ▶▶ Enhanced Mode SATA and PATA drives are auto-detected and placed in Native mode.

Note: Pre-Win2000 operating system do not work in Enhanced mode.

Advanced Chipset Control

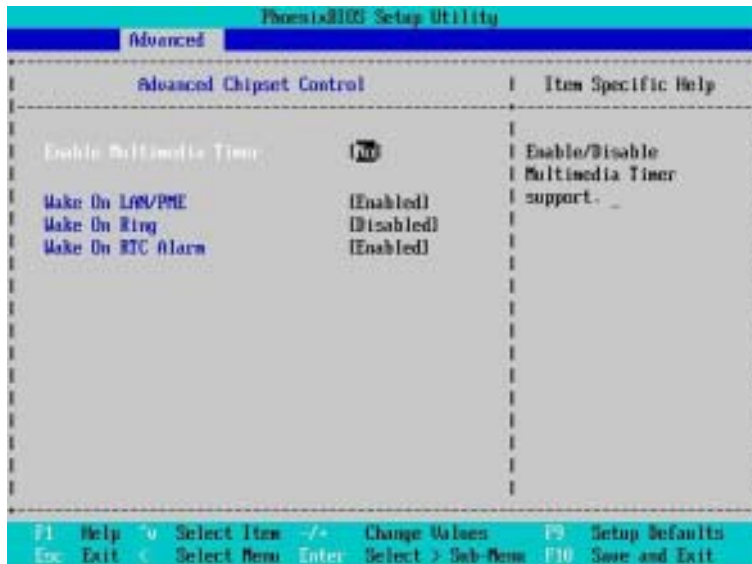

Figure 2-4: Advanced Chipset Control

☞ Enable Multimedia Timer

- ▶▶ Yes Enable Multimedia Timer support.
- ▶▶ No Disable this function. (Default value)

☞ Crystal Beach Configure Enable

Enable Configuration/Memory mapped accesses to the Crystal Beach Configuration space located in Device 8, Fn0, and Fn1.

- ▶▶ Enabled Crystal Beach Configure function. (Default value)
- ▶▶ Disabled Disable this function.

Wake On LAN / PME

This option allow user to determine the action of the system when a LAN/PME wake up event occurs.

- ▶▶ Enabled Enable Wake On LAN/PME. (Default value)
- ▶▶ Disabled Disable this function.



Note: This item must enabled if you're running under Windows operating system.

Wake On Ring

This option allow user to determine the action of the system power is off and the modem is ringing.

- ▶▶ Enabled Enable Wake On Ring.
- ▶▶ Disabled Disable this function. (Default value)



Note: This item must enabled if you're running under Windows operating system.

Wake On RTC Alarm

When "RTC Alarm Resume" item is set to enabled, system will wakeup from RTC. (This item will be functionalized under ACPI OS)

- ▶▶ Enabled Enable alarm function to POWER ON system.
- ▶▶ Disabled Disable this function. (Default value)



Note: This item must enabled if you're running under Windows operating system.

Hardware Monitor

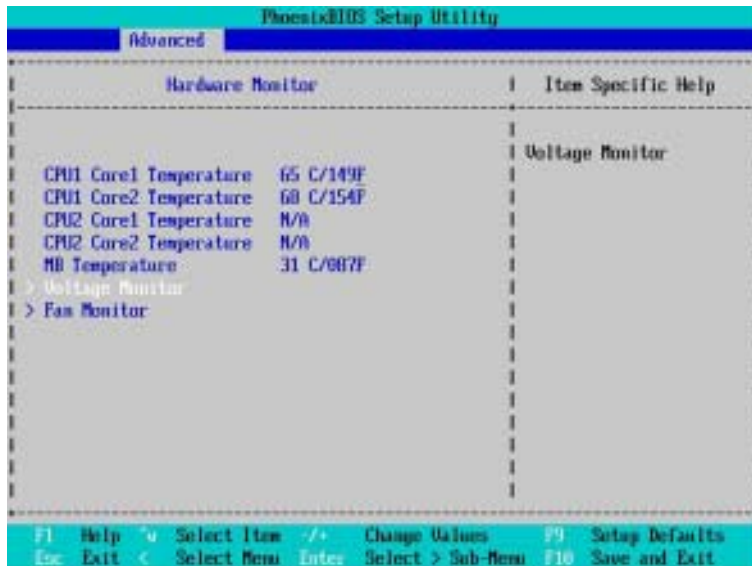

Figure 2-5: Hardware Monitor

☞ CPU1/2 Core1/2 Temperature/ Motherboard Temperature

▶▶ Display the current CPU1/CPU2 Core1/2 temperature, and Motherboard temperature.

☞ Voltage Monitor: +3.3V, +5V, VCOREA, VCOREB, VBAT

▶▶ Detect system's voltage status automatically.

☞ FAN Monitor: System 1/2/3/4/5/6 (RPM)

▶▶ Display the current System FAN 1/2/3/4/5/6 speed.



☞ Boot-time Diagnostic

When this item is enabled, system will show Diagnostic status when system boot.

- ▶▶ Enabled Enable Boot-time Diagnostic.
- ▶▶ Disabled Disable this function. (Default value)

☞ Reset Configuration Data

- ▶▶ Yes Reset all configuration data.
- ▶▶ No Do not make any changes. (Default value)

NumLock

This option allows user to select power-on state for NumLock.

- ▶▶ On Enable NumLock. (Default value)
- ▶▶ Off Disable this function.

Multiprocessor Specification

This option allows user to configure the multiprocessor(MP) specification revision level.
Some operating system will require 1.1 for compatibility reasons.

- ▶▶ 1.4 Support MPS Version 1.4 . (Default value)
- ▶▶ 1.1 Support MPS Version 1.1.

Security

🔑 About This Section: Security

In this section, user can set either supervisor or user passwords, or both for different level of password securities. In addition, user also can set the virus protection for boot sector.

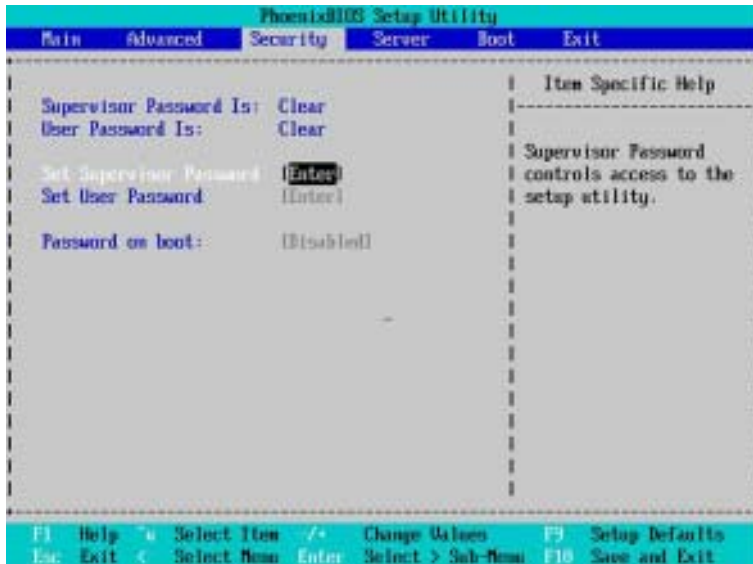

Figure 3: Security

🔑 Set Supervisor Password

You can install and change this options for the setup menus. Type the password up to 6 characters in length and press <Enter>. The password typed now will clear any previously entered password from the CMOS memory. You will be asked to confirm the entered password. Type the password again and press <Enter>. You may also press <Esc> to abort the selection and not enter a specified password or press <Enter> key to disable this option.

☞ Set User Password

You can only enter but do not have the right to change the options of the setup menus. When you select this function, the following message will appear at the center of the screen to assist you in creating a password.

Type the password up to 6 characters in length and press <Enter>. The password typed now will clear any previously entered password from the CMOS memory. You will be asked to confirm the entered password. Type the password again and press <Enter>. You may also press <Esc> to abort the selection and not enter a specified password.

☞ Password on boot

Password entering will be required when system on boot.

- ▶▶ Enabled Requires entering password when system on boot.
- ▶▶ Disabled Disable this function. (Default value)

Server

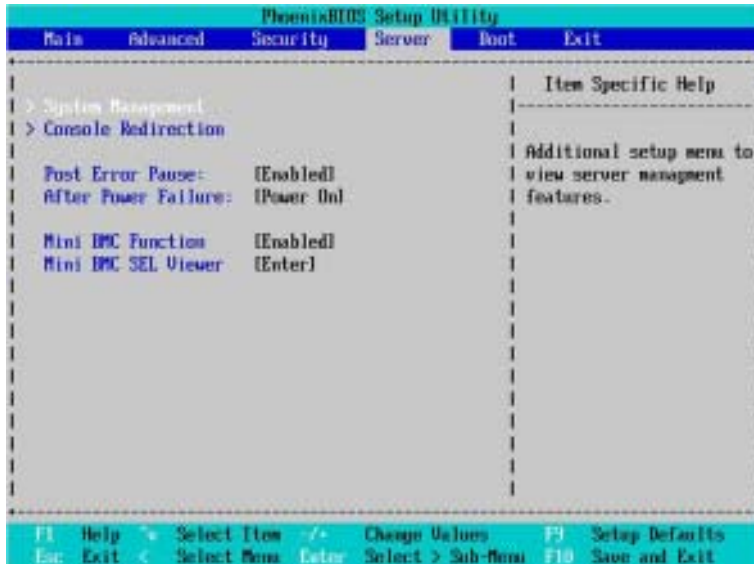

Figure 4: Server

System Management

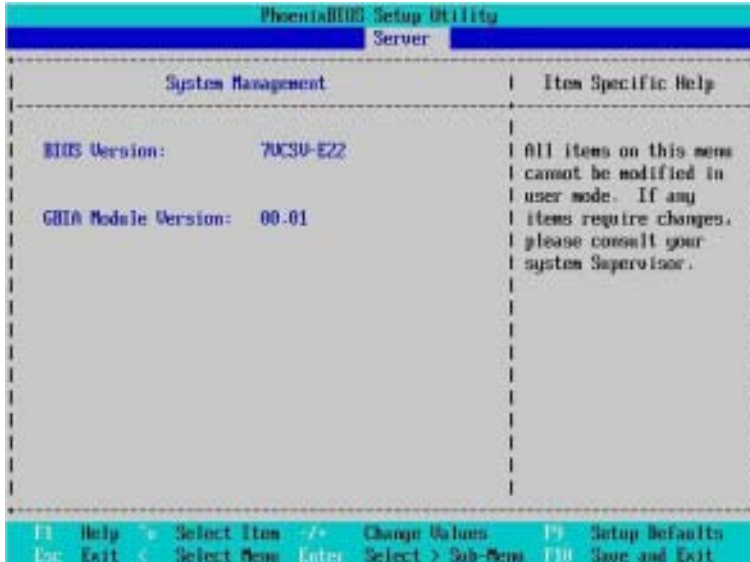

Figure 4-1: System Management

Server Management

This category allows user to view the server management features. Including information of **BIOS Version** and **GBIA Module Version**. All items in this menu cannot be modified in user's mode. If any items require changes, please consult your system supervisor.

Console Redirection

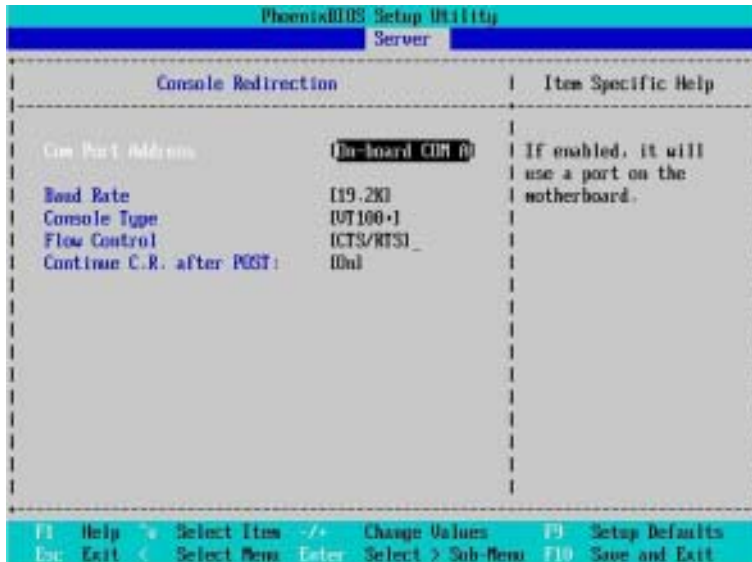

Figure 4-2: Console Redirection

☞ COM Port Address

If this option is set to enabled, it will use a port on the motherboard.

- ▶▶ On-board COMA Use COMA as the COM port address.
- ▶▶ Disabled Disable this function. (Default value)

☞ Baud Rate

This option allows user to set the specified baud rate.

- ▶▶ Options 300, 1200, 2400, 9600, 19.2K, 38.4K, 57.6K, 115.2K.

☞ Console Type

This option allows user to select the specified terminal type. This is defined by IEEE.

- ▶▶ Options VT100, VT100 8bit, PC-ANSI 7bit, VT100+, VT-UTF8.

☞ **Flow Control**

This option provide user to enable the flow control function.

- ▶▶ None Not supported.
- ▶▶ XON/OFF Software control.
- ▶▶ CTS/RTS Hardware control. (Default value)

☞ **Continue C.R. after POST**

This option allows user to enable console redirection after O.S has loaded.

- ▶▶ On Enable console redirection after O.S has loaded.
- ▶▶ Off Disable this function. (Default value)

☞ **Post Error Pause**

If this item is set to enabled, the system will wai for user intervention on critical POST errors.

If this item is disabled, the system will boot with no intervention if possible.

- ▶▶ Enabled Enable Post Error Pause. (Default value)
- ▶▶ Disabled Disable this function.

☞ **After Power Failure**

This option provides user to set the mode of operation if an AC / power loss occurs.

- ▶▶ Power On System power state when AC cord is re-plugged.
- ▶▶ Stay Off Do not power on system when AC power is back.
- ▶▶ Last State Set system to the last sate when AC power is removed. Do not power on system when AC power is back. (Default value)

🔗 Mini BMC Function

- ▶▶ Enabled Enable Mini BMC function. (Default value)
- ▶▶ Disabled Disable this function.

🔗 Mini BMCSEL View

Press [Enter] to view the Mini BMC SEL.

```
-----
BIOS System Event Log Viewer Version 0.45 (Server BIOS Team)
-----
Total Entry Number: 100
Free Space: 100
-----
0068 02/12/2005 10:14:18 44 00 F0 36 00 42 12 21 6F 01 FF FF
OEM System Boot Event (Asserted)
0067 02/12/2005 10:14:00 43 00 F0 36 00 42 04 30 01 02 FF 20
System Fan6 - Lower out of range, Critical Assertion
0066 02/12/2005 10:14:00 42 00 F0 36 00 42 04 2F 01 02 FF 20
System Fan5 - Lower out of range, Critical Assertion
0065 02/12/2005 10:14:00 41 00 F0 36 00 42 02 15 01 59 00 E2
VCC3 - Upper out of range, Critical Assertion
0064 02/12/2005 10:14:06 40 00 EE 36 00 42 1F 22 6F 06 FF FF
POST system event (Asserted)
0063 02/12/2005 10:14:01 3F 00 E9 36 00 42 12 21 6F 01 FF FF
OEM System Boot Event (Asserted)
0062 02/12/2005 10:13:44 3E 00 80 36 00 42 04 30 01 02 FF 20
System Fan6 - Lower out of range, Critical Assertion
0061 02/12/2005 10:13:44 3D 00 80 36 00 42 04 2F 01 02 FF 20
System Fan5 - Lower out of range, Critical Assertion
-----
ESC:Exit ^/e:Line Up/Down PgUp/PgDn:Previous/Next Page F1:Refresh F2:Clear
```

Boot

🔗 About This Section: Boot

The "Boot" menu allows user to select among four possible types of boot devices listed using the up and down arrow keys. By applying <+> and <Space> key, you can promote devices and by using the <-> key, you can demote devices. Promotion or demotion of devices alerts the priority that the system uses to search for boot device on system power on.

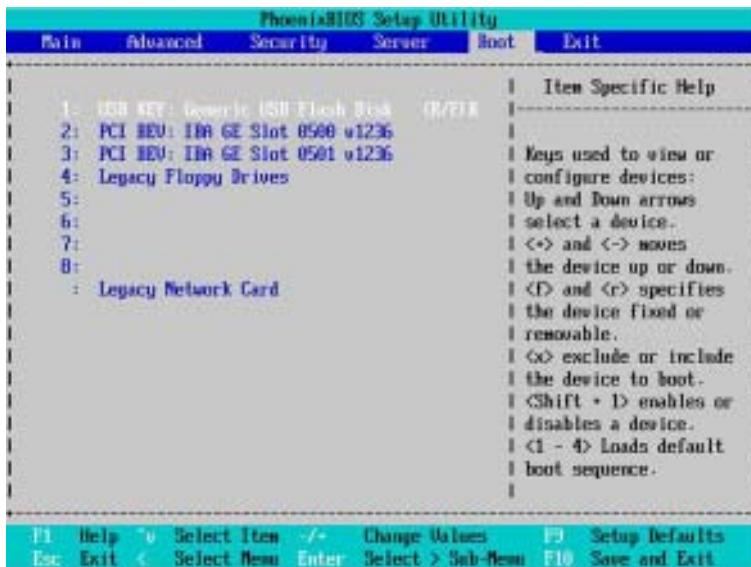

Figure 5: Boot

🔗 Boot Priority Order

This field determines which type of device the system attempt to boot from after **PhoenixBIOS Post** completed. Specifies the boot sequence from the available devices. If the first device is not a bootable device, the system will seek for next available device.

Key used to view ot configure devices:

Up and Down arrows select a device.

<+> and <-> moves the device up or down.

<f> and <r> specifies the device fixed or removable.

<x> exclude or include the device to boot.

<1-4> Loads default boot sequence.

Exit

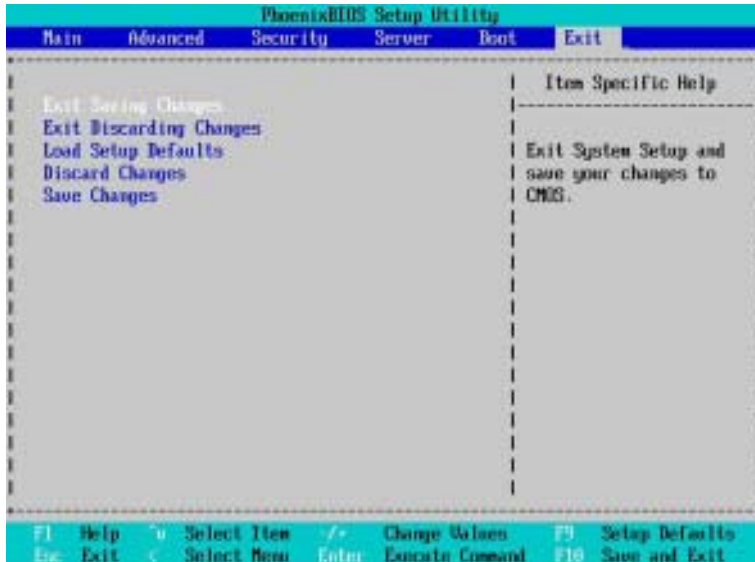

Figure 6: Exit

🔑 About This Section: Exit

Once you have changed all of the set values in the BIOS setup, you should save your changes and exit BIOS setup program. Select “Exit” from the menu bar, to display the following sub-menu.

- ☛ Exit Saving Changes
- ☛ Exit Discarding Changes
- ☛ Load Setup Default
- ☛ Discard Change
- ☛ Save Changes

Exit Saving Changes

This option allows user to exit system setup with saving the changes.

Press <Enter> on this item to ask for the following confirmation message:

Pressing 'Y' to store all the present setting values tha user made in this time into CMOS.

Therefore, whenyou boot up your computer next time, the BIOS will re-configure your system according data in CMOS.

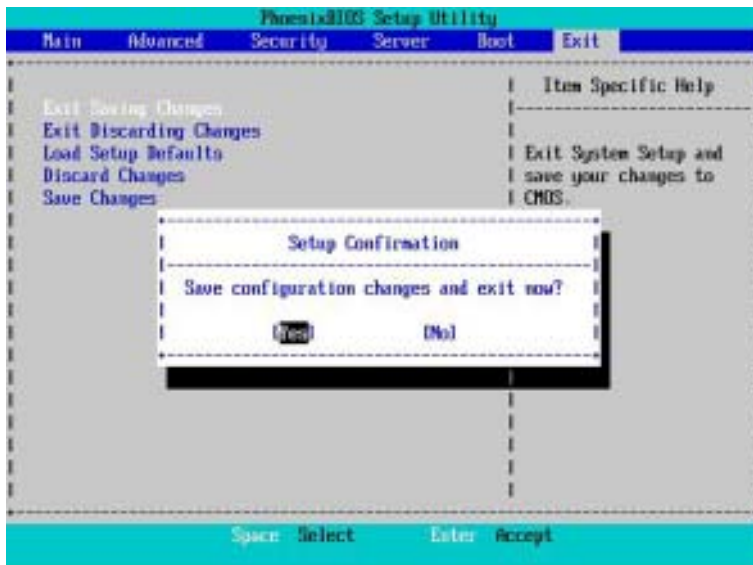

☞ Exit Discarding Changes

This option allows user to exit system setup without changing any previous settings values in CMOS. The previous selection remain in effect.

This will exit the Setup Utility and restart your computer when selecting this option.

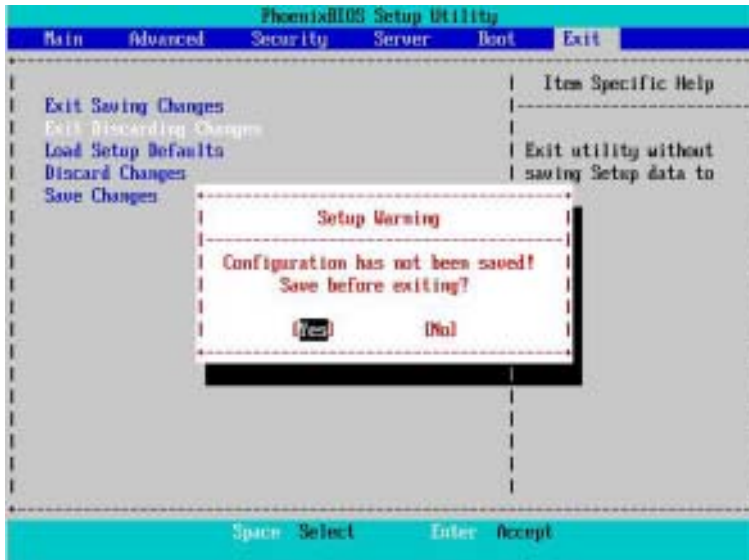

☞ Load Setup Default

This option allows user to load default values for all setup items.

When you press <Enter> on this item, you will get a confirmation dialog box with a message as below:

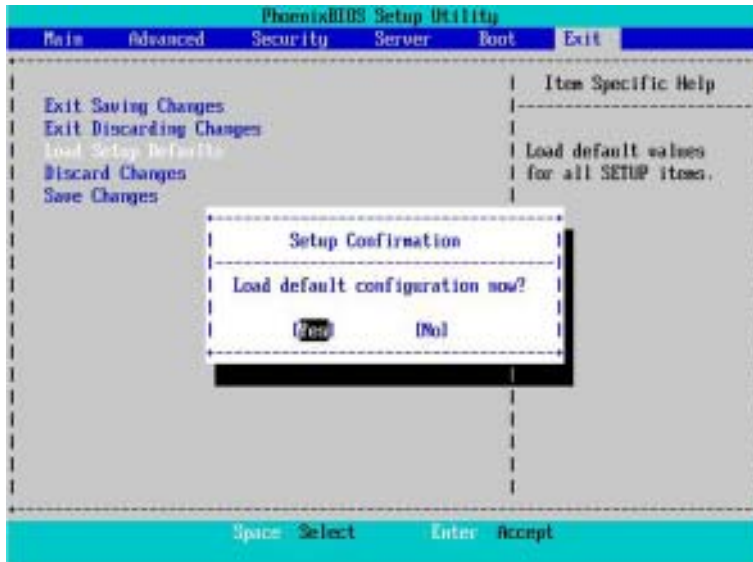

☞ Discard Changes

This option allows user to load previous values from CMOS for all setup item.

When you press <Enter> on this item, you will get a confirmation dialog box with a message as below:



Save Changes

This option allows user to save setup data to CMOS.

When you press <Enter> on this item, you will get a confirmation dialog box with a message as below:

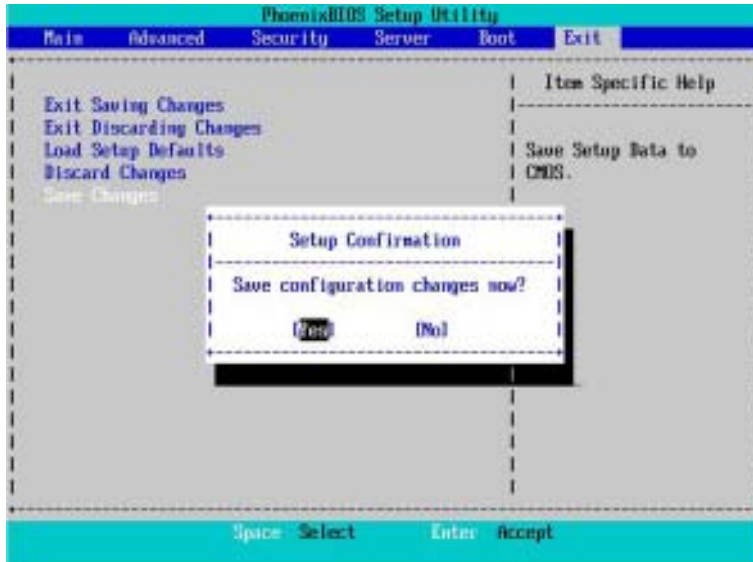

Press [Yes] to save setup data to CMOS.

Chapter 4 Block Diagram

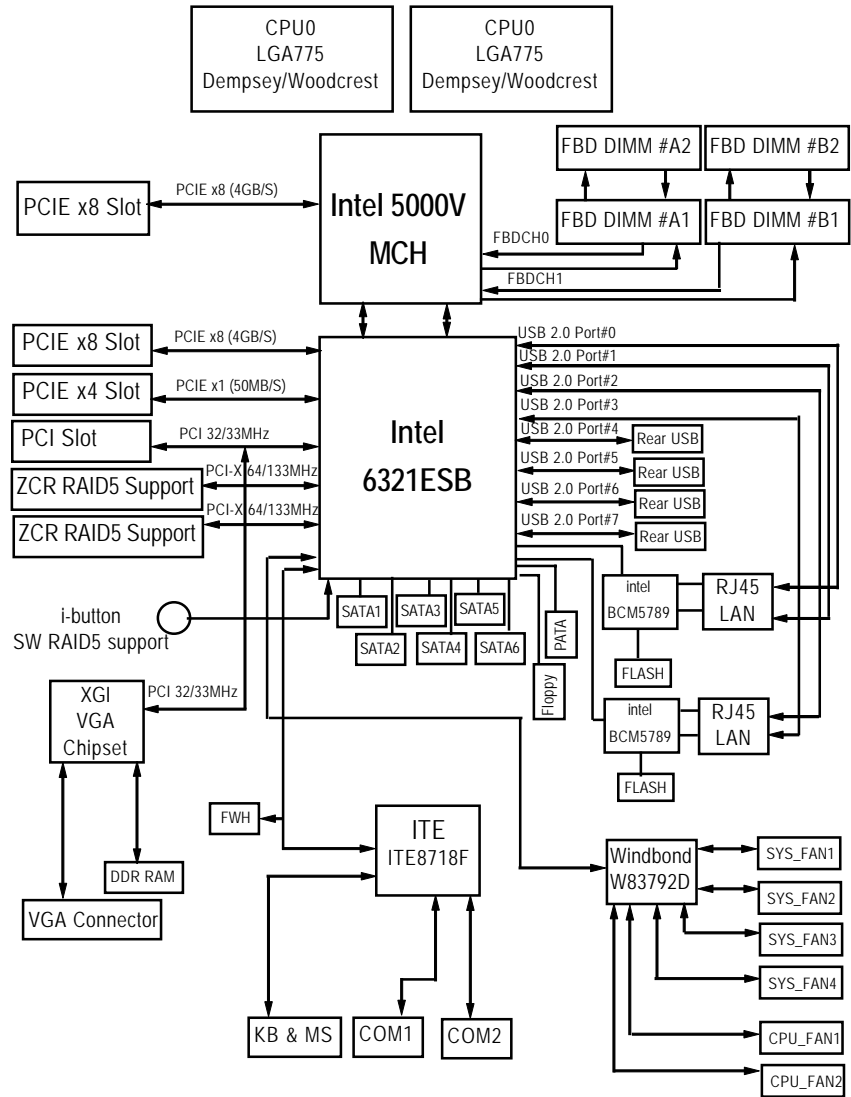

Chapter 5 Driver Installation

A. Intel Chipset Software Installation Utilities

Insert the driver CD-title that came with your motherboard into your CD-ROM driver, the driver CD-title will auto start and show a series of Setup Wizard dialog boxes. If not, please double click the CD-ROM device icon in "My computer", and execute the setup.exe.

Installation Procedures:

1. The CD auto run program starts, **Double click** on "Intel Chipset Software Installation Utilities" to start the installation.
2. Then, a series of installation wizards appear. Follow up the wizards to install the drivers.
3. Setup completed, click "Finish" to restart your computer.

Auto Run window



(1)

Setup Wizard

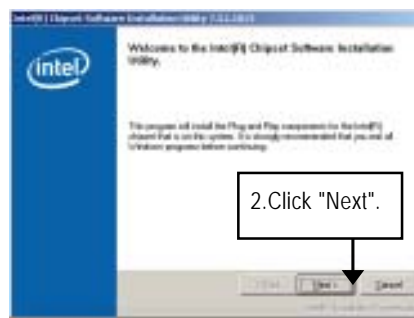

(2)

License Agreement

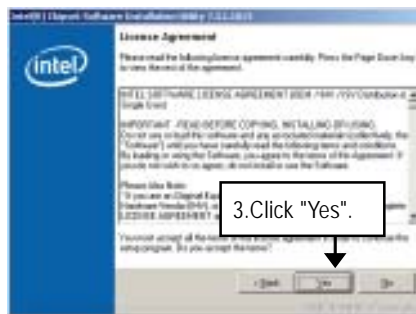

(3)

Readme Information

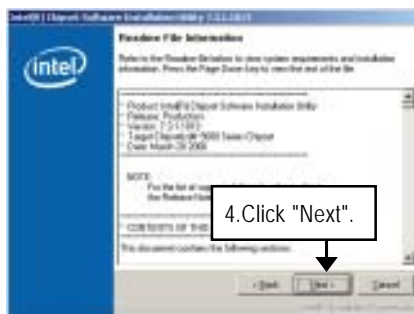

(4)

Installation Completed



5. Installation completed, Click "Finish" to restart computer.

(5)

B. Broadcom LAN Driver Installation

Insert the driver CD-title that came with your motherboard into your CD-ROM driver, the driver CD-title will auto start and show a series of Setup Wizard dialog boxes. If not, please double click the CD-ROM device icon in "My computer", and execute the setup.exe.

Installation Procedures:

1. The CD auto run program starts, **Double click** on "Broadcom LAN Driver" to start the installation.
2. Then, a series of installation wizards appear. Follow up the wizards to install the applications.

Auto Run window



(1)

Installation Wizard

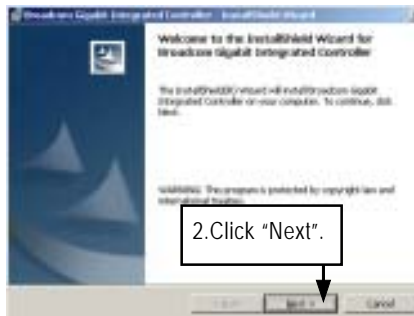

(2)

License Agreement

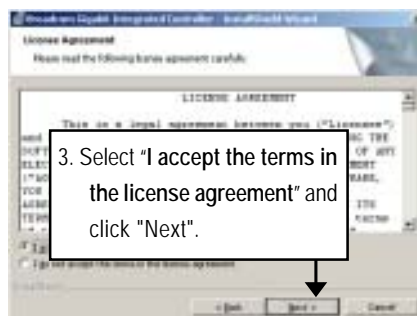

(3)

Ready to install the program

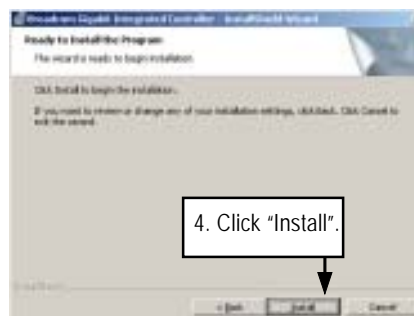

(4)

Installation Complete

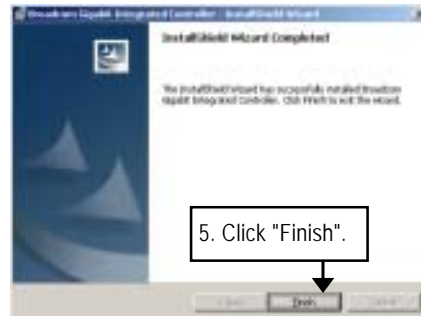

(5)

C. Intel RAID Driver Installation

Installation Procedures:

1. The CD auto run program starts, **Double click** on "Intel Host RAID Driver" to make a driver disk.
2. Select a folder referring to your operating system.
3. Insert a floppy disk in the floppy drive. Click on the self-extractor file.
4. System starts making a driver disk automatically.
5. Driver disk creation completed.

Auto Run window



(1)

Starting make a driver disk

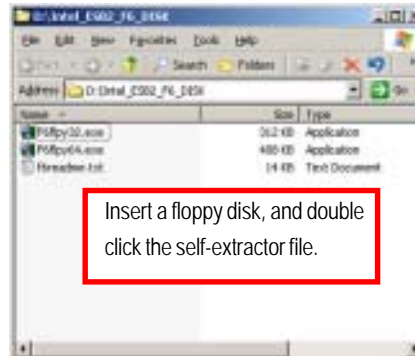

(2)

Formatting and writing in floppy disk

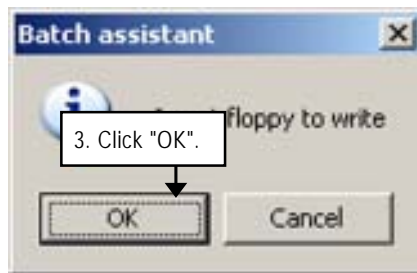

(3)

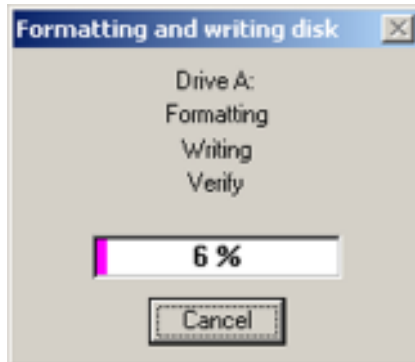

(4)

D. XGI VGA Driver Installation

Insert the driver CD-title that came with your motherboard into your CD-ROM driver, the driver CD-title will auto start and show a series of Setup Wizard dialog boxes. If not, please double click the CD-ROM device icon in "My computer", and execute the setup.exe.

Installation Procedures:

1. The CD auto run program starts, **Double click** on "XGI VGA Driver" to start the installation.
2. Double click on "**Display Driver**" item. Then, a series of installation wizards appear. Follow up the wizards to install the drivers.
3. Setup completed, click "Finish" to restart your computer.

Auto Run window



(1)

Setup Wizard

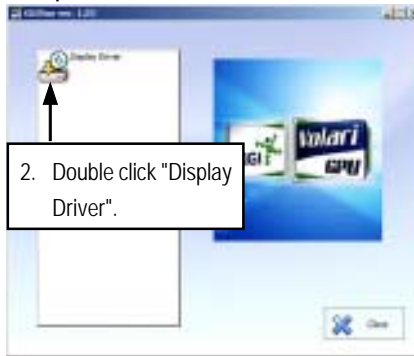

(2)

Installation Wizard



(3)

Installation Complete

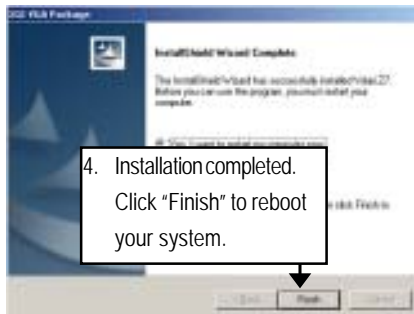

(4)

E. Matrix Storage Manager Utility Installation

Insert the driver CD-title that came with your motherboard into your CD-ROM drive, the driver CD-title will auto start and show the installation guide. If not, please double click the CD-ROM device icon in "My computer", and execute the setup.exe.

Installation Procedures:

1. The CD auto run program starts, **Double click** on "Direct9.0" to start the installation.
2. Then, a series of installation wizards appear. Follow up the wizards to install the drivers.
3. Setup completed, click "Finish" to restart your computer.

Auto Run window



(1)

Setup Wizard

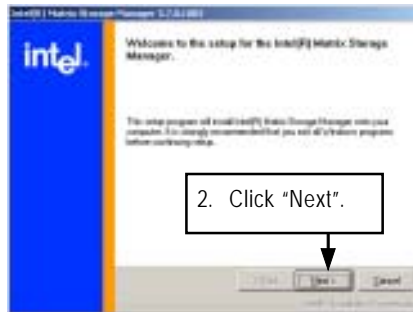

(2)

Warning Information

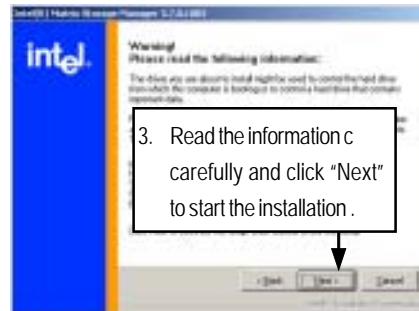

(3)

License Agreement

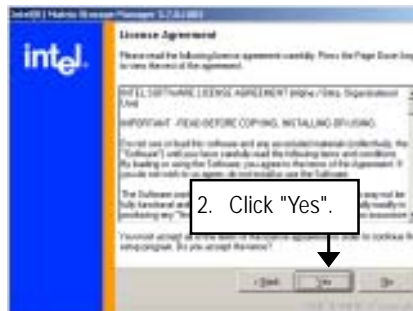

(4)

Readme Information

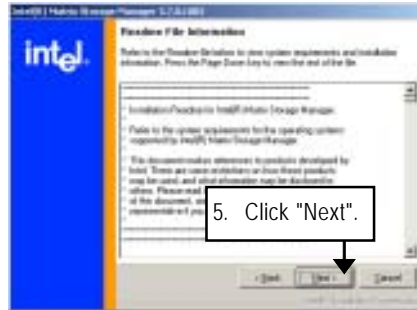

(5)

Installation Wizard completed

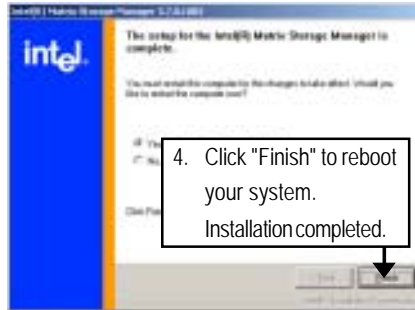

(6)

F. DirectX 9.0C Driver Installation

Insert the driver CD-title that came with your motherboard into your CD-ROM driver, the driver CD-title will auto start and show the installation guide. If not, please double click the CD-ROM device icon in "My computer", and execute the setup.exe.

Installation Procedures:

1. The CD auto run program starts, **Double click** on "Directx9.0" to start the installation.
2. Then, a series of installation wizards appear. Follow up the wizards to install the drivers.
3. Setup completed, click "Finish" to restart your computer.

Auto Run windows



1. Click "DirectX 9.0C Driver" item

(1)

License Agreement



2. Select "I accept the agreement" and click "Next".

(2)

Starting Installaiton

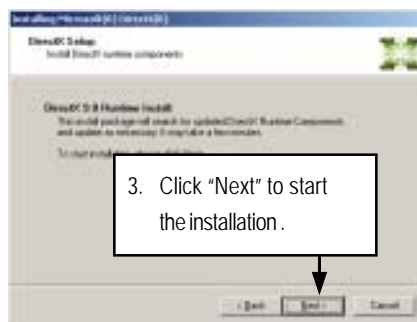

3. Click "Next" to start the installation .

(3)

Installaiton Wizard completed



4. Click "Finish". Installation complet.

(4)

Chapter 6 Appendix

Acronyms

Acronyms	Meaning
ACPI	Advanced Configuration and Power Interface
APM	Advanced Power Management
AGP	Accelerated Graphics Port
AMR	Audio Modem Riser
ACR	Advanced Communications Riser
BBS	BIOS Boot Specification
BIOS	Basic Input / Output System
CPU	Central Processing Unit
CMOS	Complementary Metal Oxide Semiconductor
CRIMM	Continuity RIMM
CNR	Communication and Networking Riser
DMA	Direct Memory Access
DMI	Desktop Management Interface
DIMM	Dual Inline Memory Module
DRM	Dual Retention Mechanism
DRAM	Dynamic Random Access Memory
DDR	Double Data Rate
ECP	Extended Capabilities Port
ESCD	Extended System Configuration Data
ECC	Error Checking and Correcting
EMC	Electromagnetic Compatibility
EPP	Enhanced Parallel Port
ESD	Electrostatic Discharge
FDD	Floppy Disk Device
FSB	Front Side Bus
HDD	Hard Disk Device
IDE	Integrated Dual Channel Enhanced
IRQ	Interrupt Request

Acronyms	Meaning
I/O	Input / Output
IOAPIC	Input Output Advanced Programmable Input Controller
ISA	Industry Standard Architecture
LAN	Local Area Network
LBA	Logical Block Addressing
LED	Light Emitting Diode
MHz	Megahertz
MIDI	Musical Instrument Digital Interface
MTH	Memory Translator Hub
MPT	Memory Protocol Translator
NIC	Network Interface Card
OS	Operating System
OEM	Original Equipment Manufacturer
PAC	PCI A.G.P. Controller
POST	Power-On Self Test
PCI	Peripheral Component Interconnect
RIMM	Rambus in-line Memory Module
SCI	Special Circumstance Instructions
SECC	Single Edge Contact Cartridge
SRAM	Static Random Access Memory
SMP	Symmetric Multi-Processing
SMI	System Management Interrupt
USB	Universal Serial Bus
VID	Voltage ID
