

Copyright©2006  
All Right Reserved – Printed in China

W251U Notebook User's Manual

Original Issue: 2006/02

This manual guides you in setting up and using your new Notebook PC. Information in the manual has been carefully checked for accuracy and is subject to change without notice.

No part of this manual may be reproduced, stored in a retrieval system, or transmitted, in any form or by any means, electronic, mechanical, photocopy, recording, or otherwise, without prior written consent.

#### Trademarks

Product names used herein are for identification purposes only and may be the trademarks of their respective companies.

Microsoft®, MS-DOS, Windows®, and Windows® Sound System are trademarks of Microsoft Corporation.

Intel®, Centrino™, Pentium® M, Banias, Calexico are registered trademarks of Intel Corporation.

Sound Blaster, Sound Blaster Pro are trademarks of Creative Technology.

All other brands or product names mentioned in this manual are trademarks or registered trademarks of their respective companies.

## Safety Instructions

Use the following safety guidelines to help protect yourself and your notebook.

### When Using Your W251U Notebook Computer



**CAUTION:** Do not operate your portable computer for an extended period of time with the base resting directly on your body. With extended operation, heat can build up in the base.

Allowing sustained contact with the skin can cause discomfort or a burn.

- Do not attempt to service the notebook yourself. Always follow installation instructions closely.
- Do not carry a battery in your pocket, purse, or other container where metal objects (such as car keys) could short-circuit the battery terminals. The resulting excessive current flow can generate extremely high temperature and may cause burns to your skin.
- Be sure that nothing rests on your AC adapter's power cable and that the cable is not located where it can be tripped over or stepped on.
- While you are using the computer or charging the battery, place the AC adapter in a ventilated area, like on a desktop or on the floor. Do not cover the AC adapter with papers or other items that may prevent ventilation. Also, do not use the AC adapter while it is inside a carrying case.
- Do not insert objects into the air vent of your notebook computer. Doing so can cause short-circuiting and may result in fire or electrical

shock.

- Use only the AC adapter and batteries that are supplied by your notebook manufacturer. Using other types of battery or AC adapter may heighten the risk of fire or explosion.
- Incorrectly placed batteries may result in an explosion.
- Replace only with the same or compatible battery recommended by the manufacturer.
- Please discard used batteries according to the manufacturer's instructions.
- Before you connect your notebook to a power source, ensure that the voltage rating of the AC adapter matches that of the available power source.
  - 115 V/60 Hz in most of North and South America and some Far Eastern countries such as South Korea and Taiwan.
  - 100 V/50 Hz in eastern Japan and 100 V/60Hz in western Japan.
  - 230 V/50 Hz in most of Europe, the Middle East, and the Far East.
- If you use an extension cord with your AC adapter, ensure that the total ampere rating of all devices plugged into the extension cord does not exceed its total capacity.
- When removing battery from your notebook, first turn off the system, disconnect the AC adapter from the electrical outlet, then remove the battery.
- To avoid risk of an electrical shock, do not connect or disconnect any cables, or perform maintenance or reconfiguration of this product during a thunderstorm.
- Do not throw batteries into fire, doing so may cause explosion. Check with local authorities first for battery disposal instructions.
- When setting up your notebook for work, place it on a level sur-

face.

- When traveling, do not check your notebook as baggage. You can put your notebook through an X-ray security machine, but never put your notebook through a metal detector. If you have your notebook checked by hand, be sure to have a charged battery ready in case you are asked to turn on your notebook.
- When traveling with the hard drive removed from your notebook, wrap the drive in an insulated material, such as cloth or paper. If you have the drive checked by hand, you may be asked to install the drive into your notebook. You can have the hard drive checked through an X-ray machine, but never put the drive through a metal detector.
- When traveling, do not place your notebook in the overhead storage compartment where it could shift around. Do not drop your notebook or subject it to other mechanical shocks.
- Protect your notebook, battery, and hard drive from environmental hazards such as dirt, dust, food, liquids, extreme temperature, and direct exposure to sunlight.
- When you move your notebook in environments where there is a substantial difference of temperature or humidity level, condensation may form on or within your notebook. To avoid damaging your notebook, please allow sufficient time for the moisture to evaporate before continue using.

*NOTICE: When taking your notebook from a colder to a warmer environment or vice versa, allow your notebook enough time to adapt to the new environment before turning on power.*

- When unplugging the power cord, please make sure that you pull on its connector or on its strain relief loop, and not on the power

cord itself. As you pull out the connector, please ensure that it is pulled out evenly in order not to bend its connecting pins. Also, before you connect the power cord, make sure that both connectors are correctly oriented and aligned.

- Before you clean your notebook, turn it off first, unplug it from its power source, and remove the battery.
- Handle interior components with care. When removing a component, please hold it by the edge and not on the connecting pins (such as the memory module).



When using your telephone equipments, safety instructions should always be followed in order to prevent fire, electrical shock or injuries, these instructions include:

- Do not use this product near water, for example, near a bathtub, washing basins, kitchen/laundry sinks, wet basements or swimming pools.
- Avoid using cordless phones during an electrical storm as lightning may cause electrical shocks.
- Do not use the telephone to report a gas leak within the leakage area.

#### WARNING: Void of Warranty

- \* If the battery is not properly handled, there may be a risk of explosion; make sure you are using the same or compatible battery.
- \* Please discard used batteries according to the instructions given by the manufacturer.
- \* Please be aware that use of cracked, severely scratched or poor quality discs may damage the optical drive and corrupt data in the disc. Such discs may break while drive operates in high-speed, in this case, your product warranty may be voided.

## Regulatory Notices

### Federal Communications Commission Notice

This equipment has been tested and found to comply with the limits for a Class B digital service, pursuant to Part 15 of the FCC rules. These limits are designed to provide reasonable protection against harmful interference in a residential installation.

Any changes or modifications made to this equipment may void the user's authority to operate this equipment.

This equipment generates, uses, and can radiate radio frequency energy. If not installed and used in accordance with the instructions, may cause harmful interference to radio communications. However, there is no guarantee that interference will not occur in a particular installation. If this equipment does cause harmful interference to radio or television reception, which can be determined by turning the equipment off and on, the user is encouraged to try to correct the interference by one or more of the following measures:

- Reorient or relocate the receiving antenna.
- Increase the separation between the equipment and receiver.
- Connect the equipment into an outlet on a circuit different from that to which the receiver is connected.
- Consult the dealer or an experienced radio/TV technician for help.
- All external cables connecting to this basic unit must be shielded.

For cables connecting to PCMCIA cards, see the option manual or installation instructions.

### Federal Communications Commission (FCC)

#### PART 68 Warning

This equipment complies with Part 68 of the FCC Rules. On the bottom of the computer is a label that contains, among other information, the FCC Registration Number and Ringer Equivalence Number (REN) for this equipment. You must, upon request, provide this information to your telephone company.

FCC Part 68 Registration Number: 6CTTAI - 25876 - FB - E

#### REN: 0.8B

The REN is useful to determine the quantity of devices you may connect to your telephone and still have those devices ring when your number is called. In most, but not all areas, the sum of the REN's of all devices should not exceed five (5.0). To be certain of the number of devices you may connect to your line, as determined by the REN, you should call your local telephone company to determine the maximum REN for your calling area.

If your MODEM causes harm to the telephone network, the local Telephone Company may discontinue your service temporarily. If possible, they will notify you in advance. However, if advanced notice isn't practical, you will be notified as soon as possible. You will be informed of your right to file a complaint with the FCC.

Your telephone company may make changes in its facilities, equipment, operations, or procedures that could affect the proper functioning for your equipment. If they do, you will be notified in advance to give you an opportunity to maintain an uninterrupted telephone service.

### CE Notice (European Union)

This symbol  indicates this W251U notebook computer complies with the EMC Directive and the European Union's Low Voltage Directive. This symbol also indicates that W251U meets the following technical standards:

- EN 55022 — “Limitations and Methods of Measurement for the Radio Interferences of Information Technology Equipment.”
- EN 55024 — “Information technology equipment - Immunity characteristics - Limits and methods of measurement.”
- EN 61000-3-2 — “Electromagnetic compatibility (EMC) - Chapter 3: Limits - Section 2: Limits on the harmonic current emissions (Equipment input current up to and including 16 A per phase).”
- EN 61000-3-3 — “Electromagnetic compatibility (EMC) - Chapter 3: Limits - Section 3: Limits on the voltage fluctuations and flicker in low-voltage power supply systems for equipment with rate current up to and including 16 A.”
- EN 60950 — “Safety of Information Technology Equipment.”



NOTE: EN 55022 emissions requirements provide for two classifications

- Class A governs commercial use
- Class B is governs residential use

### BSMI Notice (Taiwan Only)

Most notebook computers are classified by the Bureau of Standards, Meteorology and Inspection (BSMI) as Class B information technology equipment (ITE).



R32323

The symbol above must be attached to the product indicating compliance with the BSMI standard.



CCC Notice (China Only)

On Class A systems, the following warning will appear near the regulation label:

Warning: This is a Class A product. In a domestic environment, this product may cause radio interference, in which case users may be required to take adequate measures.

#### 声明

此为 A 级产品，在生活环境中，该产品可能会造成无线电干扰。在这种情况下，可能需要用户对其干扰采取切实可行的措施。



## Preface

Congratulations on your purchase of a Notebook computer! Your new notebook features the most innovative features in portable computing technology. It combines state-of-the-art ergonomics with sophisticated architecture, providing you with a personal computer that is compact, powerful, and easy to use. Designed for a wide range of general, business, and personal productivity applications, this notebook is an ideal choice for use in the office, at home, and on the road.

This Manual contains all the information you need to set up and use your notebook computer. It describes all of its features in a thorough yet easy-to-read manner.

# Content

Safety Instructions .....	I
Regulatory Notices .....	III
Preface .....	V

## Chapter 1 The Grand Tour

1.1 The Outside of W251U Notebook Computer .....	02
1.2 Status LED Indicator .....	05

## Chapter 2 Operating Basics

2.1 Using the Battery Pack .....	07
2.2 Connecting the AC Power Source .....	08
2.3 Turning Your Notebook On and Off .....	08
2.4 Installing W251U Notebook Computer Device Drivers .....	09
2.5 Using the Launch Keys .....	09
2.6 Keyboard Functions .....	10
2.7 Using the TouchPad .....	13
2.8 Storage .....	14
2.9 Introducing the W251U camera .....	15

## Chapter 3 Personalize Your W251U Notebook Computer

3.1 How to restore to the Factory Restore Point .....	17
3.2 BIOS Settings .....	19
3.3 BIOS update .....	23
3.4 Graphics System .....	25
3.5 Protecting Your W251U Notebook Computer .....	26

## Chapter 4 Connecting to Peripherals

4.1 Using USB Port .....	28
4.2 Connecting to an External Monitor .....	28

4.3 Using the LAN Port .....	29
4.4 Using the Modem Port .....	29
4.5 IEEE 1394 Port .....	30
4.6 PCI Express card/Newcard Slot .....	30
4.7 Connecting to your S-Video Port .....	31
4.8 Using your Bluetooth devices .....	31
4.9 SD/MMC/MS/MS Pro Cards .....	31

## Chapter 5 Troubleshooting

5.1 Frequently Asked Questions .....	33
--------------------------------------	----

Appendix A System Information .....	35
-------------------------------------	----

Appendix B Service Center .....	37
---------------------------------	----





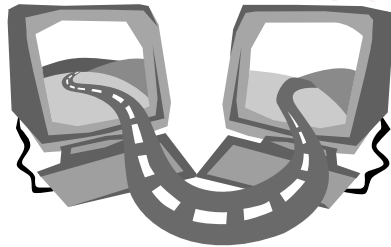

## Chapter 1 The Grand Tour

This chapter will show you basic components of the computer and briefly explain how they function.

## 1.1 The Outside of W251U Notebook Computer

► Front View ◀

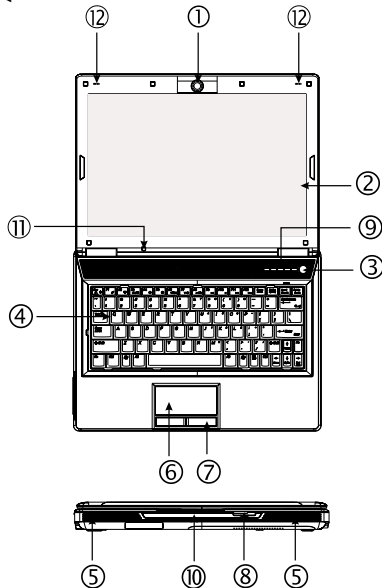

### 1 Webcam/Digital Camera

The webcam enables you to videoconference with your colleagues or friends and family. It is also a 1.3 Megapixel digital camera.

### 2 LCD Glare Type Display Panel

LCD is an acronym for Liquid-Crystal Display (LCD), which outputs data and images onto its screen. The W251U's LCD display

panel is a special type called the "Glare Type", with a mirror-like screen, giving you clearer viewing experiences.

### 3 Power Button

Turn the computer on and off, or resumes whenever it is in suspend mode.

### 4 Keyboard

Inputs data into your computer.

### 5 Speakers

The built-in dual speakers output stereo sound.

### 6 Touchpad

Use it to move the pointer, select and activate items on the screen.

### 7 Touchpad buttons

Function like the left and right buttons of a regular mouse.

### 8 Memory Card slot

Accepts SD/MMC/MS/MS Pro Modules (insert only one card at a time).

### 9 Launch Keys

Buttons for launching frequently used programs.

### 10 Status LED Indicator (**Please refer to Chapter 1.2 below**)

Light-Emitting Diodes (LEDs) shows the status of the computer's functions and components.

### 11 Light Sensor

Automatically detects lighting in your current environment.

### 12 Dual Array Microphone

Your W251U notebook computer comes with a pair of Dual Array Microphones for enhanced audio outputs; particularly when used during videoconferences and with voice recognition devices.

## ► Left View ◀

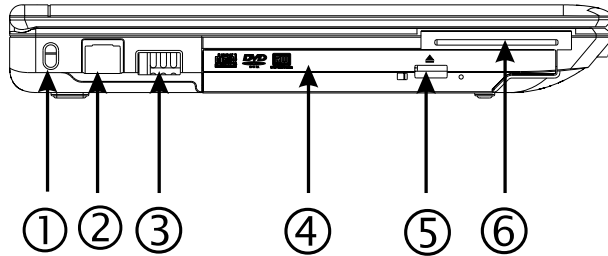

- 1 Kensington Lock Port  
Connects a Kensington-compatible security lock.
- 2 LAN Port  
The LAN port is used to connect your notebook computer to a Local Area Network (LAN), or to other computers within the network.
- 3 USB Port  
Connects to USB Devices.
- 4 Optical Drive  
Internal optical drive, load programs from a Compact Disc (CD) or a Digital Versatile Disc (DVD).
- 5 Optical Drive Eject Button  
Ejecting the optical drive tray.
- 6 New Card Slot  
Accepts additional New Card-compatible modules.

## ► Right View ◀

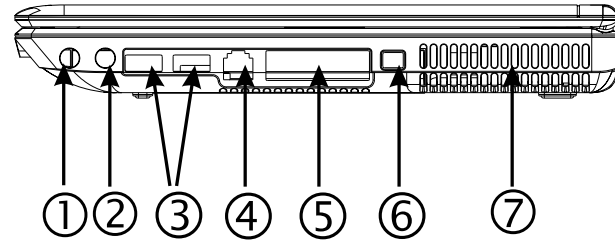

- 1 Speaker/Headphone Jack  
Connects to stereo headphone, speakers, or earphone set.
- 2 Microphone-in jack  
Connects to an external microphone.
- 3 USB Ports  
Connects to your favorite USB peripherals.
- 4 Modem Port  
Connects to a phone jack through an RJ-11 cable.
- 5 VGA External Video Display Port  
Connects to an external monitor.
- 6 IEEE 1394 Port  
Connects to your IEEE1394 (Firewire) compatible devices.
- 7 Fan/Heat Vent  
The built-in fan ventilates heat inside your computer.

► Back View ◀

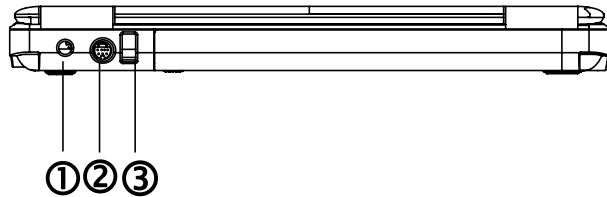

- 1 Power Port  
Connects to an AC Adapter
- 2 S-Video Port  
Connects to an external video source, such as your television set.
- 3 USB Port  
Connects to USB devices (e.g., USB mouse, USB camera...etc)

► Bottom View ◀

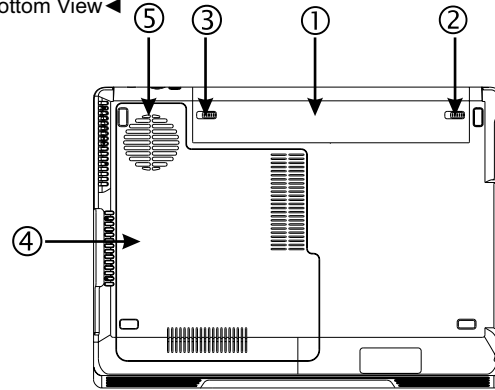

- 1 Battery Bay  
Equipped with a Lithium-Ion (Li-Ion) battery pack.
- 2 Battery Release Latch  
Push latch to remove battery.
- 3 Battery latch lock  
Push latch to the left to lock battery compartment.
- 4 CPU/HDD/Memory/Wireless Lan Card Compartment  
This compartment contains CPU, hard drive, memory and Wireless LAN modules.

\*\*\*\*For warranty reasons, it is not recommended to install and uninstall components on your own, please contact your vendors for more information.\*\*\*\*

- 5 Fan  
It provides air flow to cool off internal components.

## 1.2 Status LED Indicator

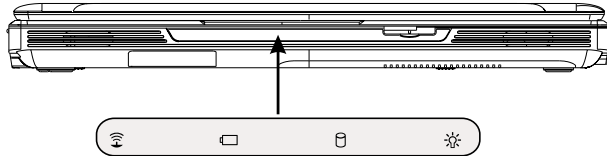

### Power

It glows blue when the computer is on, and flashes blue when the computer is in the suspend mode.

The light is off when the computer is completely shut down or in the Hibernation mode.

### Battery Indicator

The battery indicator light tells you whether the Lithium ion battery is charging, not charged, or already fully charged.

### Hard Drive Activity Indicator

The hard drive activity indicator tells you whether your internal hard drive is being accessed.

### Wireless LAN Activity Indicator

The wireless LAN activity indicator tells you whether or not your computer is connected to a wireless network.

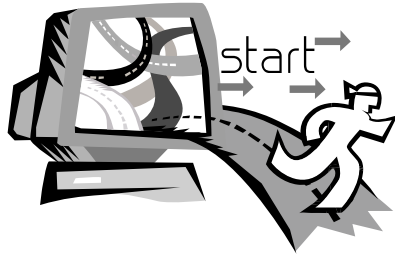

## Chapter 2 Operating Basics

This chapter will show you how to operate your W251U notebook computer, including connecting the AC adaptor, turning the computer on/off, using touch-pad, keyboard, hot keys, battery, and so on. If you are new to computers and to the operating system, this chapter will guide you through some of the new exciting features.

## 2.1 Using the Battery Pack

W251U notebook computer is designed to operate with one of the following power sources:

- AC power  
(using the AC adapter connected to an electrical outlet)
- Lithium-Ion (Li-Ion) battery pack

You should use the AC adapter whenever possible; use the battery pack only when AC power is unavailable. The rechargeable Li-Ion battery pack allows you to operate your notebook computer without an external power source. When you use the AC adapter to connect your notebook to a power outlet, the internal battery will begin to recharge. While the battery is charging, the Battery Charge icon on the indicator panel will be on. Once the battery is fully charged, the Battery Charge icon will turn off. Quick charging time is 2.5 hours for the Lithium-Ion (Li-Ion) battery when the computer is turned off, while the normal battery charging time is 3.5 hours.

- Operating a fax modem, video, or audio equipment can increase the use of your computer's power.
- Decreasing monitor brightness can also save power.
- When the battery is not fully charged, allow your battery to be charged completely before using it (i.e., before disconnecting AC power). Calibrating the battery before use is also highly recommended.
- Li-Ion Battery is vulnerable, do not charge it with other power adapter, otherwise fire or explosion may occur.

### ► Replacing the Battery ◀

The battery will gradually weaken over time. We recommend that you replace your battery when you notice a significant decrease of battery capacity.

To change the battery pack, follow the steps below:

1. Turn off the computer.
2. Close the lid and flip the computer over.
3. Slide the side battery latch (1) to the left. Continue to hold it until the battery is removed.
4. Make sure the replacement battery is properly oriented before inserting it into the battery compartment.

### ► Maintenance of the AC Adapter ◀

- Do not connect the adapter to any other device.
- Do not step on the power cord or place heavy objects on top of it. Carefully route the power cord and keep cables away from all traffic.
- When unplugging the power cord, do not pull on the cord itself but on the plug instead.
- If you are using an extension cord, make sure that the devices plugged onto the cord do not exceed its total capacity. Furthermore, the devices plugged into the electrical outlet shall not exceed the fuse's total ampere rating.
- Please verify power voltage before connecting the electrical cord to the power outlet. If you are uncertain of its power specification, please consult with your local vendors or power company for more details.

*Note:* The battery can not be charged to 100% when remaining battery is no less than 95%. It is based on the supplier's advice, and to extend charging frequency and battery life.

## 2.2 Connecting the AC Adapter

The AC adapter converts AC power to DC power and reduces the voltage supplied to the computer. It can automatically adjust to any voltage from 100 to 240 volts and outputs power at 20 volts, 3.25A, allowing you to use your notebook computer in almost any region.

*CAUTION: Use only the AC adapter and the power cord we recommend. Using the wrong adapter may damage your computer. We assume no responsibilities for damages arising from misuse of AC adapters.*

To properly connect the adapter, follow the steps as below:



1. Connect the power cord to the AC adapter.
2. Connect the AC adapter to the DC power port on the back of your computer.
3. Connect the AC adapter power cord to an AC outlet.

## 2.3 Turning Your Notebook On and Off

### ▶ Turning on the power ◀

Open the notebook lid, press and hold the power button for one or two seconds. The power indicator will glow blue once the computer is powered on.

### ▶ Turning off the power ◀

If you are not going to use your notebook computer for a while, it is best to turn off its power. Before turning off power, close all programs first and shut down the operating system.

After turning off your notebook computer, make it a habit to leave the LCD panel open for a while after it has been used for an extended period of time. This allows the interior of your notebook computer to cool off. Closing the panel will force the heat up against the LCD screen, and doing so after a while may damage the screen. More importantly, never close the LCD panel for a long period of time when the computer is on or when the power saving function is disabled.

### ▶ Suspend mode ◀

You can adjust default power management settings in the Power Option/Advanced dialog box. The Power Options dialog box provides several operating functions after your computer has been idle for a while.



## 2.4 Installing W251U Device Drivers

If your W251U Notebook Computer already has an operating system installed, it is best to install all necessary device drivers in order for the hardware to properly function.

Before installing drivers, check with your vendors to see if they have already installed all the drivers with the operating system, if not, please follow the steps below:

1. You can find the Utility Driver CD like the one shown below:



2. Put the CD into the CD R-W or DVD-RW (optional) Drive. An Auto Run installation screen will appear.

## 2.5 Using the Launch Keys

The easy access buttons located to the left of the power button allow you to easily access the internet and your E-Mail client (such as Microsoft® Outlook).

There are 5 launch keys found next to the power button:













1. **Wireless/Bluetooth**  
Press to activate wireless function.
2. **Fanless**  
Press this button to reduce fan noise (Silent Mode).
3. **Multimedia**  
Press to launch your multimedia player.
4. **E-Mail**  
This button launches your E-Mail client (such as Microsoft® Outlook).
5. **Internet**  
Opens up your Internet Explorer browser.









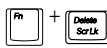

## 2.6 Keyboard Functions

W251U series notebook computer is equipped with a standard typewriter-layout keyboard and has extra features.

### Basic Keypad

Keypad	Function Description
	<Enter> key. Execute a command. Within many text editing programs, the <Enter> key inserts a hard carriage return, just like what an ordinary typewriter does.
	<Esc> key. Press this key to cancel or escape from a command or function.
	<Insert> key. Known as the Insert key. Press this key to change from insert to type over mode.
	<Fn>+<PrtSc> key. Known as the Print Screen key. Press this key to map the whole screen to share memory for your specific usage.
	<Delete> key. Known as the Delete key. Press this key to delete the character to the right of the cursor, or delete marked texts or items.
	<Pause> key. Press this key to temporarily halt execution of a command. Pressing any other keys to resume execution of a command.
	<Fn>+<Break> key. Press this key to temporarily halt execution of a command. Pressing any other keys to resume execution of a command.

	<Shift> key. Press this key in combination with letters to produce uppercase letters in typing. Use this key in combination with those two-character keys (found on the second row of the keyboard) to produce the upper marked keys. Also used in most programs in combination with other keys to execute a certain command.
	<Tab> key. Press this key to move the cursor to the next tab on the right. This key works much the same way as on an ordinary typewriter.
	<Ctrl> key. Known as the Control key. Used in most programs in combination with other keys to execute a command.
	<Alt> key. Known as the Alternate key. Used in most programs in combination with other keys to execute a command.

	<Fn>+<Scr Lk> key. Used in most programs to scroll the screen without having to move the cursor. The keys are in color-coded blue.
	<Cap Lock> key. Used in most programs to always activate uppercase letters.
	Up arrow key. Moves the cursor up one line at a time.
	Down arrow key. Moves the cursor down one line at a time.
	Left arrow key. Moves the cursor to the left one space at a time.
	Right arrow key. Moves the cursor to the right one space at a time.
	<Home> key. Moves the cursor to the beginning of a screen or line.
	<PgUp> key. Moves the cursor up one screen at a time.
	<PgDn> key. Moves the cursor down one screen at a time.
	<End> key. Moves the cursor to the end of a screen or a line.

### Special Function Keys

► Embedded Numeric Keypad ◀

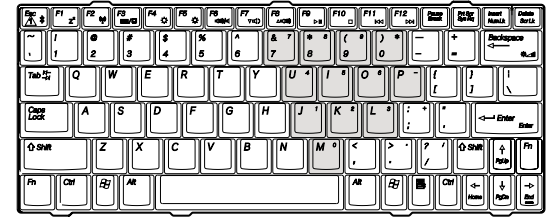

The embedded numeric keypad functions like the one on a desktop keyboard. It is indicated by small characters located on the upper right-hand corner of the keycaps.

Desired Access	Num Lock On	Num Lock Off
Number keys on embedded keypad	Type numbers in a normal manner	
Cursor-control keys/embedded keypad	Hold Shift while using cursor-control keys	Hold Fn while using cursor-control keys
Main Keyboard keys	Hold Fn while typing letters on embedded keypad	Type the letters in a normal manner

Note: If an external keyboard or keypad is connected to your notebook computer, the Numlock automatically shifts from an internal keyboard to the external keyboard or keypad.

## ► Windows Keys ◀

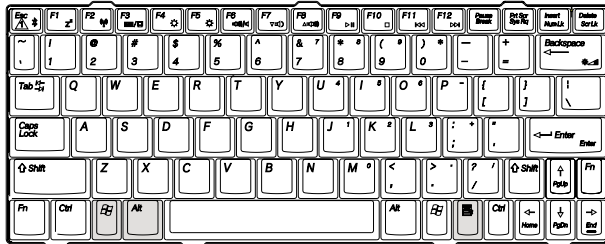

Key	Description
⊞+[F1]	Opens help and support
⊞+E	Explores my computer
⊞+F	Finds document
⊞+M	Minimizes all
⊞+ Shift + M	Undoes minimize all
⊞+ R	Displays run dialog box
⊞+ Tab	Activates next taskbar button

## ► Basic keypad ◀

you can input letters, numbers, punctuation marks, and special symbols with it.

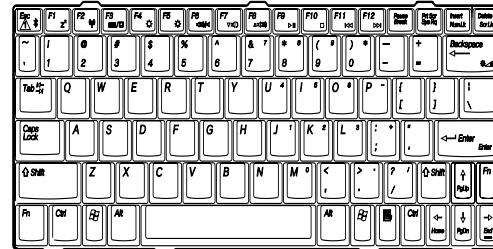

## ► Fn Keys ◀

By pressing the Fn keys with other keys, it can simulate all keyboard functions of a regular desktop keyboard.

[Fn]+[F1]	Suspend switch
[Fn]+[F2]	Activate or deactivate wireless functions
[Fn]+[F3]	Switch between LCD or CRT monitor
[Fn]+[F4]	Increase screen brightness
[Fn]+[F5]	Decrease screen brightness
[Fn]+[F6]	Audio mute
[Fn]+[F7]	Decrease audio volume
[Fn]+[F8]	Increase audio volume
[Fn]+[F9]	Play or pause media player
[Fn]+[F10]	Stop media player
[Fn]+[F11]	Media player skip backward
[Fn]+[F12]	Media player skip forward
[Fn]+[Esc]	Enable or disable Bluetooth function
[Fn]+[Backspace]	Activate light sensor

## 2.7 Using the Touchpad

The Touchpad is a pressure-sensitive pointing device that provides all of the features of a two-button mouse; its primary function is to move the cursor around the screen.

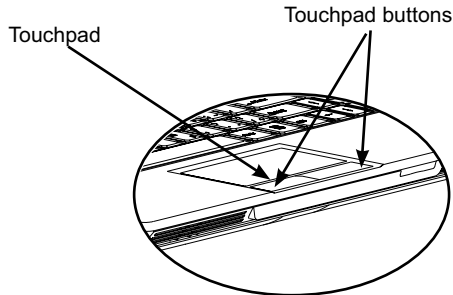

*Since the Touchpad is a pressure-sensitive device, therefore proper care should be attended to in order to prevent damage. Please also note the following precautions:*

- *Make sure the touchpad does not come into contact with dirt, liquid or grease.*
- *Do not touch the touchpad if your fingers are dirty.*
- *Do not place heavy objects on the touchpad or on the touchpad buttons.*

### ► Clicking ◀

You can move the pointer over to the item with your finger on the pad, and click once on the left button below to select it, or simply tap once on the touchpad.

### ► Double Clicking ◀

Move the pointer over to the item with your finger on the pad, and click twice on the left button to select menu items, or simply tap twice on the touchpad.

### ► To drag and drop ◀

Move the pointer over to the item with your finger on the pad, click once on the left button beneath the Touchpad and select the item you want, once the item is selected, you can then drag the item by gliding your finger on the Touchpad (clicking twice on the Touchpad buttons equals to the speed of a double-click on a regular mouse).

### ► The Scroll buttons ◀

If you are scrolling through the document, you may do so by gliding your finger on the Touchpad while holding the scroll button.

*You may adjust your Touchpad settings by going into Start/Control Panel /Mouse/Buttons. You can change the Touchpad's operating orientations through these settings, for example changing from right-handed to left-handed operations. You may also adjust cursor speed as well as response time of mouse clicks.*

## 2.8 Storage

### ▶ Hard Disk ◀

The W251U notebook computer is equipped with a built-in large capacity 2.5 inch IDE hard disk drive where you store or install your computer operating system as well as software programs. The internal hard disk is normally assigned as Drive C after formatting.

- If you wish to replace your hard disk, contact your local vendor for information about your notebook computer's hardware setup.
- You can increase the system's storage capacity by replacing the standard hard disk drive with a drive of a greater capacity.
- Always turn off your notebook computer before removing the hard drive. Failure to do so will damage the computer and the hard disk. Avoid jarring or moving your computer while the hard disk is still being accessed.

### ▶ Optical Disc Drive ◀

W251U notebook computer is equipped with one of the following optical drives:

DVD combo / DVD Dual / DVD-Super Multi

The optical drive is normally used for installing operating system and software programs. To insert and remove a disc from the drive:

1. Press the button on the front of the drive to eject the disc tray and gently pull out the tray.
2. Place the disc on the tray with label side up.
3. Place the disc on the spindle and press it down gently until the disc clicks into place.

4. Slide the tray back until it clicks shut.

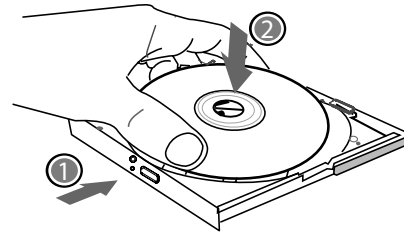

*Warning: When the computer is reading from the optical drive, the indicator light for the DVD-ROM will flash on. Do not attempt to remove the disc while the indicator light is still active.*

*Warning: Do not insert any foreign objects into the disc tray. Do not force the tray to open or close. When the drive is not in use, keep the tray closed in order to prevent dust or dirt from entering the drive.*

*If you experience difficulty when removing a disc, stick a paper clip (or use a pin or a thin metal rod) into the emergency eject hole, the CD disc tray should eject immediately. This procedure can also be used to remove a CD from the drive when the notebook is powered off.*

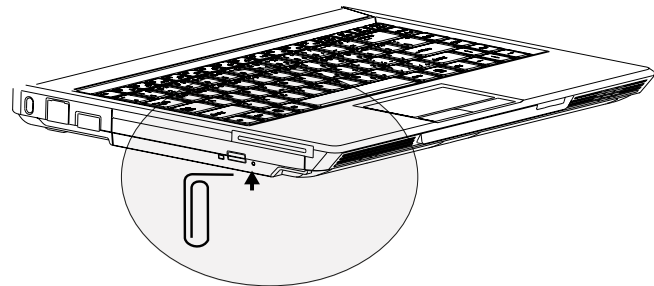

## 2.9 Introducing the W251U camera

Your W251U notebook computer comes with a built-in camera. With this camera, you can conduct videoconferences with your friends or colleagues whenever and wherever as if they are right in front of you. It also works as a digital camera (with a resolution up to 1.3 Megapixel) that you can use to take snapshots instantly.





## Chapter 3 Personalize Your W251U Notebook Computer

This chapter will explain how to use the BIOS setup utility. The W251U Notebook Computer has a BIOS setup utility which allows you to configure important system settings. You will also learn how to upgrade components in order to improve system performance. If you have questions about any of these settings, please contact your vendor.



### 3.1 How to restore to factory default settings

1. Power on your computer. If it is already running, reboot it (re-start/reset).
2. As soon as you see things (logo, graphic, text) start to appear on the screen, press and hold down the F9 key. (Typically, F9 is the “hot key” that starts Recover Pro. Contact your PC manufacturer in case this key does not work.)



The cME Console screen will then appear. This screen is for accessing the cME application.

Your Phoenix cME Console opening screen may not match the one shown above, and the number of available applications may also vary.

- Under normal circumstances, you can click and select menu options with your mouse when running FirstWare Recover Pro. If for whatever reasons your mouse is not functioning, then press the Tab and the Enter keys to highlight and select the desired option.

#### ► Running the cME Version of Recover Pro ◀

Once the cME version of Recover Pro is running, follow the steps below.

1. On the menu screen, select **Factory Restore**, then you will see the Select Recover Type menu.
2. Select a recovery option.
  - Click on the desired option, or
  - Press the Tab key until the desired option is highlighted, then press the space bar.

**Recover Boot Partition**—Select this option if you know that your hard drive is already partitioned into several drives, if you would like to recover only the boot partition, then select this option. However, the Recover Boot Partition option may not be available to all computers.

**Recover Full Drive**—Select this option if your drive has never been partitioned and/or you want to recover the entire drive. The entire primary drive (usually C:) will be recovered.

**Cancel and Exit**—Select this option if you do not want to run FirstWare Recover Pro at this time.

- If you are unsure which option to choose and want to minimize the number of deleted files, first select Recover Boot Partition.
- If, after selecting the first option, the recovery process does not successfully restore your operating system, run FirstWare Recover Pro again, and select the second option - Recover Full Drive.
- It is recommended that you not choose Recover Boot Partition if the drive does not already contain a partition.

After you select an option, a confirmation dialog box (identical or similar to the one shown here) will appear.

3. Confirm that you want to continue. Click **Yes** to begin the recovery process. Or—if not using the mouse—press **Tab** to select and then press **the space bar**. (Selecting **No** will bring you back to the previous screen from which you can exit FirstWare Recover Pro.)

Start the recovery process, and the FirstWare Progress screen will appear. No further selections are required at this time.

*After running FirstWare Recover Pro, the system will be returned to the basic factory setting. If you recover the entire hard drive (not just a boot partition), all data (files) you have created and stored on your system's hard drive, as well as all programs previously installed will be lost.*

#### ► Monitoring the Recovery Process ◀

While the FirstWare Recover Pro Progress screen is updating, you can monitor its recovery progress.

The screen will display several types of information during the recovery process:



- Percentage of recovery completed
- Time elapsed
- Estimated time remaining

The time it takes FirstWare Recover Pro to complete the recovery process ranges from 15 minutes to an hour, depending on the size of the recovery image. The more applications and utilities that were included in the factory setup, the longer the process will take.

- Amount of data (in Kilobytes) to be recovered

**Cancel**—If you select **Cancel**, the recovery process will stop, yet the system will become unbootable. It is recommended that you select **Cancel** only when you plan to delay the recovery process.

#### ► Successful Recovery ◀

When the recovery process is successfully completed, the following situations will take place automatically:

- The progress screen will disappear once the FirstWare Recover progress reaches 100%.
- The computer will reboot.
- Operating system will start, and desktop will appear.

*The start-up of the operating system indicates success of the recovery process.*

The operating system should now be working, and factory-installed applications should now be available and functional. However your personal files are no longer available

FirstWare Recover Pro will remain in the protected area of your computer system in case you need to run it again in the future.

### 3.2 BIOS Settings

The BIOS setup utility allows you to configure your computer's basic settings. When you turn on your computer, the system reads the configuration information and initializes hardware in order for the system to operate properly. You can use the BIOS setup utility to change your computer's start-up configuration. For example, you can change the security and power management settings for your computer.

You can only enter the BIOS setup utility only when the computer is turned on, in another word, between the time it's turned on and before the Windows splash screen appears. If your computer is already turned on, reboot your computer and press the F2 key to enter the setup utility.

#### ► Navigating and Entering Information in BIOS ◀

Use the following keys to move between fields and to enter information:

Item	Description
←→	Select Screen
↑↓	Push the up and down arrow keys to move among selections, then press Enter to make a selection.
+ -	Change Option
<b>Tab</b>	Select Field

<b>F1</b>	General Help
<b>F10</b>	Save and Exit
<b>ESC</b>	In any area, you can simply Press <b>Esc</b> to exit. If you wish to exit the BIOS utility without saving changes, go to the main menu, then press <b>Esc</b> .

Users are allowed to enter new values to replace the default values in certain fields, and the rest is considered to be system defaults and cannot be modified. To change settings in the Main Menu, press the Enter key to enter into submenus. To return to the previous screen, press the Esc key.

► The Main Menu ◀

BIOS SETUP UTILITY	
Main	Advanced Security Boot Info Exit
<b>System Time:</b> [23:43:17] System Date: [01/01/2006]	Item Specific Help
► <b>SATA Hard Drive:</b> [ST98823AS ] ► <b>CD-ROM/DVD-ROM:</b> [None]	<TAB>, <Shift-Tab>, or <Enter> Selects field.
F1 Help ↑↓ Select Item -/+ Change Values F9 Setup Defaults ESC Exit- Select Menu Enter Select►SubMenu F10 Save and Exit	

► Advanced Menu ◀

BIOS SETUP UTILITY	
Main	Advanced Security Boot Info Exit
► <b>Video Features</b> ► <b>Internal Devices Configurations</b>	Item Specific Help
<b>Plug &amp; Play O/S:</b> [WinXP]	Select options for video display
<b>USB BIOS Legacy Support:</b> [Enabled] <b>Resume On LAN:</b> [Disabled] <b>ATA Control Mode:</b> [Enhanced] <b>AHCI Configuration:</b> [Enabled]	
F1 Help ↑↓ Select Item -/+ Change Values F9 Setup Defaults ESC Exit- Select Menu Enter Select►SubMenu F10 Save and Exit	



► Boot menu ◀

BIOS SETUP UTILITY

Main Advanced Security <b>Boot</b> Info Exit	
Boot Menu: [Enabled] Boot Time Diagnostic Screen: [Disabled] Preboot Execution Environment: [Enabled] ► Boot Device Priority	Item Specific Help <hr/> The Boot Menu Disable or Enable
F1 Help ↑↓ Select Item -/+ Change Values F9 Setup Defaults ESC Exit- Select Menu Enter Select►SubMenu F10 Save and Exit	

► Security menu ◀

BIOS SETUP UTILITY

Main Advanced <b>Security</b> Boot Info Exit	
Supervisor Password Clear User Password Is: Clear HDD Password Clear HDD Master ID 19893855  Supervisor Password [Enter] User Password [Enter] HDD Password [Enter]  Password on boot: [Disabled]	Item Specific Help <hr/> Supervisor Password controls access to the setup utility
F1 Help ↑↓ Select Item -/+ Change Values F9 Setup Defaults ESC Exit- Select Menu Enter Select►SubMenu F10 Save and Exit	

ENGLISH

► Exit menu ◀

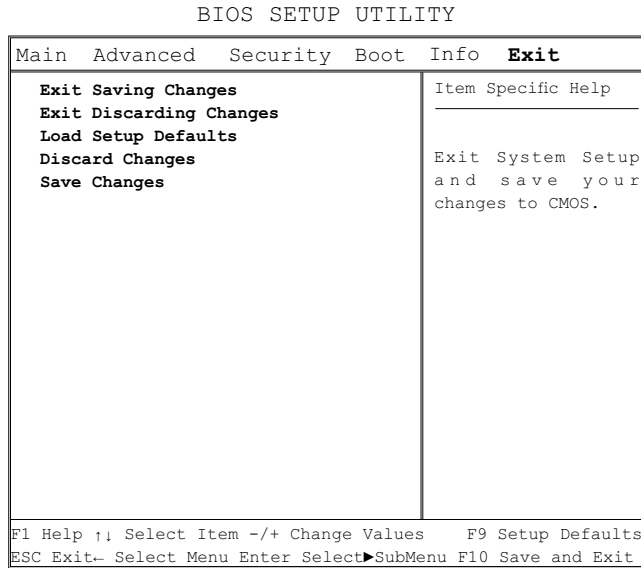

### Change User Password

You can enter into the setup utility to change or remove user passwords, however, you cannot change or remove the Supervisor password, nor can you access the diskette.

### Change Supervisor Password

A supervisor password is required before you can set a user password. After selecting Change Supervisor Password, enter a new password then re-enter it to confirm. The password you enter should contain up to 6 alphanumeric characters. If you make a mistake while entering your password, you can always press Esc to start over.

### Resetting the CMOS to Default Settings

The main page provides parameters for you to reset CMOS to default settings. After entering this page, select Load Optimal Defaults:

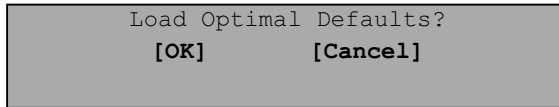

Select [OK] to reset CMOS to default settings.

### Exiting and Saving

#### • Save Settings and Exit

Select this option to save all changed settings, and restart the computer using the new settings. (Pressing F10 allows you to save settings and exit.)

#### • Exit Without Saving

Select this option to discard saved changes, and the computer will restart using the old settings.

## 3.3 BIOS Update

W251U notebook computer uses the EPROM Flash BIOS chip that allows you to easily update system BIOS.

When you update BIOS, you will lose all settings you customized. Please go to the Gigabyte website (<http://www.gigabyte.com.tw>) for the latest BIOS update utility.

To upgrade the BIOS on DOS:

1. Insert the disk with BIOS updated into the diskette drive. (USB FDD, USB Flash Disc, or Floppy Disc)
2. Power on the system with the diskette in the diskette drive.
3. In the DOS prompt, type the following command.

```
A:\>Phlash16 xxxx.wph /s /c /mode=3
or
A:\>XXXXXX.BAT (Batch file for BIOS file)
```

4. The system will now run the BIOS update.
5. The system will shut down automatically once the update is completed.

To update BIOS in Windows:

1. Please go to <http://www.gigabyte.com.tw> (Home > Support > Notebook > BIOS > W251U) to download ❶ BIOS update tool (WinPhlash) and ❷ the latest BIOS upgrade utility.
2. Unzip the file you just downloaded.

- Run the setup.exe in your unzipped folder.
- After you have successfully installed WinFlash, click Start→ Programs, locate the WinFlash program folder, then click on WinFlash.



- Choose the desired option. Selecting “Backup BIOS and Flash BIOS with new settings” will erase all previous settings. Specify the location of your backup and new BIOS files. Click on Flash BIOS when ready.



- Click on OK to start running the program.

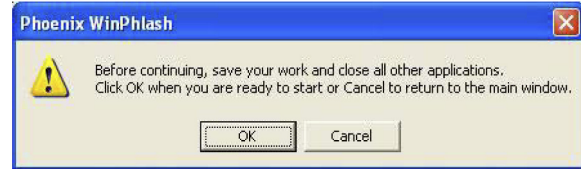

- Flash progress will be shown in the pop-up window. Please do not interrupt the process in order for the program to run correctly.

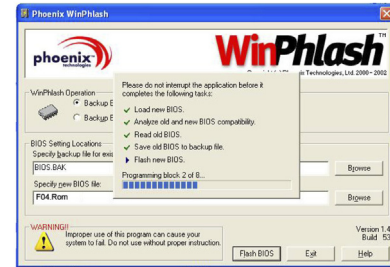

- The system will now be restarted to complete the process.

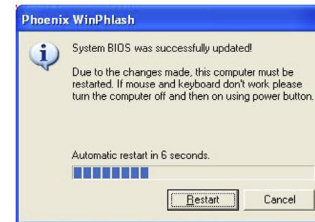



### 3.4 Graphics Display

Your computer has a high-performance graphics display system, which can easily handle the demands of today's multimedia computing.

#### ► Screen Controls ◀

##### Brightness

Function keys can increase or decrease the brightness of the monitor.

- <Fn> + <F4> decreases the LCD panel brightness
- <Fn> + <F5> increases the LCD panel brightness

##### Resolution

1. Click My Computer/Control Panel/Appearance and Themes/Display. Click on the Settings tab. The dialog box will display your monitor's current resolution.
2. Under "Screen resolution," use the slide bar to adjust monitor's resolution. Normally, you should use the resolution your LCD monitor was designed for.

*Note: Using a lower resolution than the screen was designed for will reduce the displaying area. Using the computer in DOS mode produces the same effect, because it uses a 640 by 480 resolution by default.*

#### ► Dual Displays ◀

Under Windows operating system, you may use an external monitor and your notebook's LCD screen simultaneously. You may also choose to only use the external monitor with the LCD disabled or vice versa.

1. Open Control Panel.
2. Double-click on Display. The Display Properties window will open.
3. Click on the Settings tab.
4. Click on the Advanced button.
5. Select the Intel® Graphics Media Accelerator Driver for Mobile tab.
6. Click on the Graphics Properties

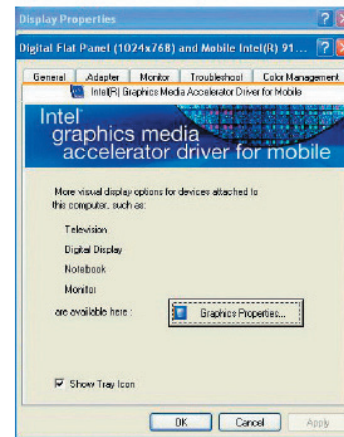

### Single

You can choose which screen to use as primary. In Single Display mode, the video display hot key is available. For example, you can press the Fn + F5 keys continuously to adjust brightness.

### Mirror

In Mirror mode, the video display hot key is also available. In this mode, you can also press Fn + F5 to change brightness. Note that CRT's video display functions the same way as an LCD screen.

*Tip: in order to ensure problem-free video display, when you use an external monitor, change the output mode in the Display properties dialog box first. After changing the output mode, you can then use the video display hot keys.*

*Note: Light or dark pixels may appear on the LCD screen as a result of LCD's manufacturing limitations, however, this will not effect your LCD screen's normal functions.*

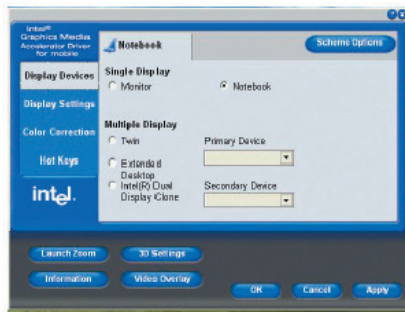

## 3.5 Protecting Your W251U Notebook Computer

The W251U Notebook Computer provides both hardware and software security locks to protect your computer.

Using a security lock:

A security lock notch can be found on the back of the computer.

This notch allows you to connect a Kensington-compatible security lock to it.

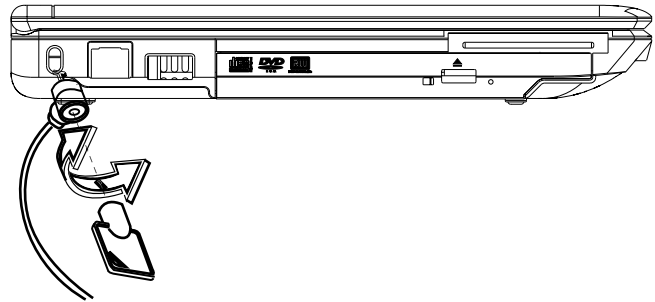



## Chapter 4 Connecting Peripherals

This chapter will show you step-by-step how to connect your peripherals to the W251U notebook computer.

## 4.1 Connecting to the USB Port

The USB port allows multiple peripherals to run simultaneously on a single computer. These peripherals may include: floppy drives, mouse, digital cameras, scanners, printers, optical disk drive, keyboards, and games devices...etc. The USB Port can also act as a hub or as an external workstation.

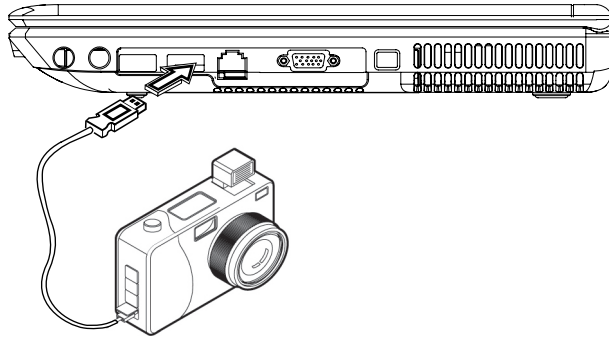

## 4.2 Connecting to an External Monitor via the VGA Port

The notebook comes with a VGA port for you to connect to an external monitor. To connect an external monitor, please follow the steps below:

1. Locate the 15-pin VGA monitor port on the right hand side of your notebook computer, then connect the video signal cable from the external monitor (or the VGA adapter) to the monitor port.
2. Connect the power cable of the external monitor to a power outlet and turn the computer on.
3. On your notebook, right-click on the Windows desktop to open the desktop menu. Click on Properties to open the Display Properties window.
4. In the Display Properties window, click on Advanced under the Settings tab, then click on the Intel® Graphics Media Accelerator Driver for mobile and make appropriate adjustments there. Now your external monitor should be able to display images on the screen.
5. Adjustments to screen resolution and color depth can also be set on this dialog box.

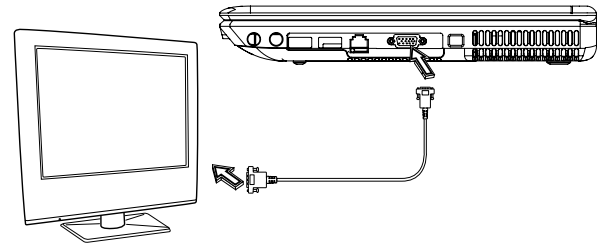

### 4.3 Using the LAN Port

1. Locate the RJ-45 cable in the accessories box that came with your notebook's shipping carton. Each end of the cable has a connector.
2. Connect one end of the cable into the network wall outlet or the HUB.
3. Connect the other end of the cable into the computer's LAN port.

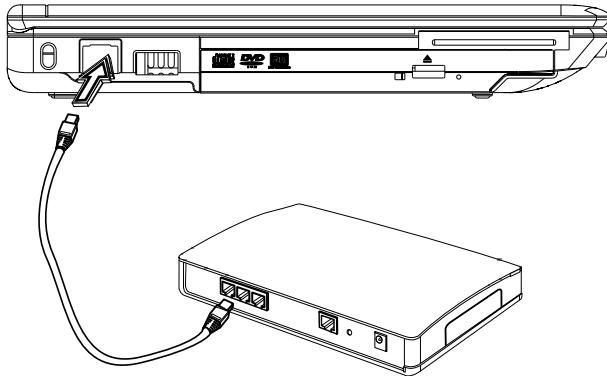

### 4.4 Using the Modem Port

The built-in fax/data modem allows you to connect a phone line to a phone jack.

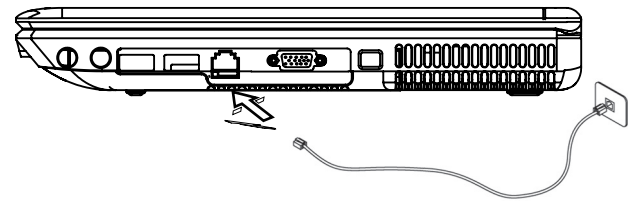

## 4.5 Using the IEEE 1394 Port

With the built-in IEEE 1394 port, you can connect your IEEE 1394-compatible peripherals for video transmission or data backup. The Windows operating system will automatically recognize the device and install appropriate driver(s) for it. Yet it is still recommended to install the drivers that came with your peripherals. For more information, please refer to your hardware manuals.

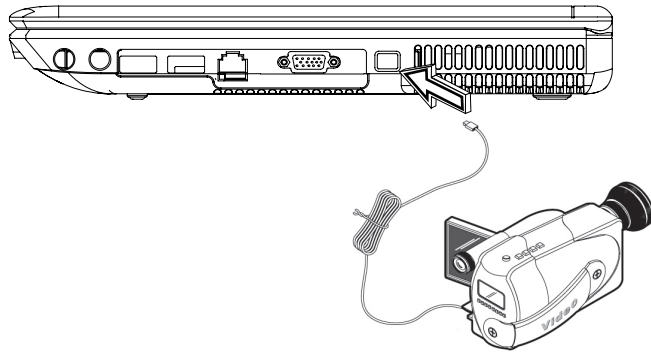

## 4.6 PCI Express card/Newcard

The PCI Express card (or Newcard) slot can be used as an interface between your computer and a variety of communication devices, such as network adapters, fax/modems or external storage devices.

### ► Inserting a Card ◀

1. Insert the card with label side up, make sure that the metal connector is inserted into the card slot.
2. Insert the card into the slot. You will feel some resistance as the card reaches to the end.
3. Your PCI Express cards require drivers, or programs that allow the operating system to use the device. Your Windows operating system should already contain the driver for your device, if not, you will be prompted to install the driver.
4. The computer will beep twice to indicate successful installation. A single beep means there was a problem recognizing the card.

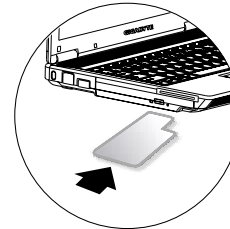

### ► Removing a Card ◀

1. Press the eject button on the card slot to release the eject button, then press the eject button again to release the card.

## 4.7 Connecting to the S-Video Port

Your W251U notebook computer comes with an S-Video port which allows you to connect your computer to an external television set. This is possible by using an S-Video cable:

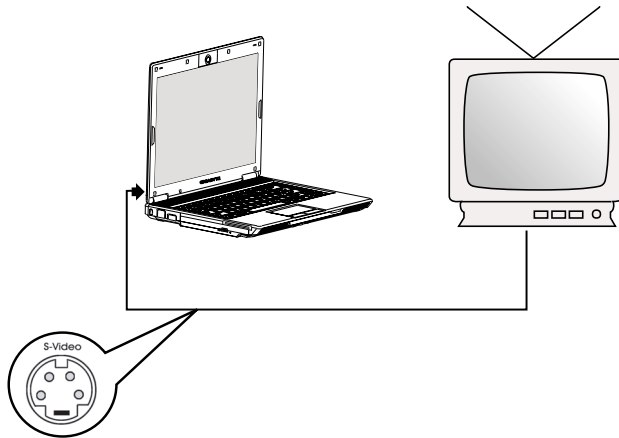

## 4.8 Using your Bluetooth and wireless devices

Your W251U computer supports both Bluetooth and Wi-Fi compatible devices. You can press Fn+Esc to enable or disable Bluetooth functions and press Fn+F2 for turning on/off wireless functions. For how to connect your Bluetooth and wireless device to your computer, please refer to the manual from your hardware manufacturers.

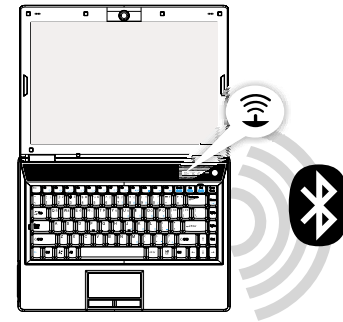

## 4.9 SD/MMC/MS/MS Pro Cards

Multimedia card slot is located on front panel of your W251U notebook computer, it accepts SD/MMC/MS/MS Pro cards.

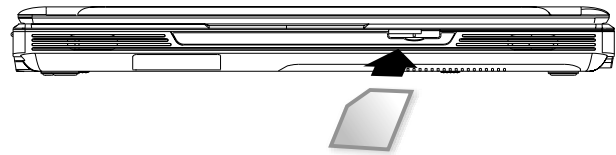

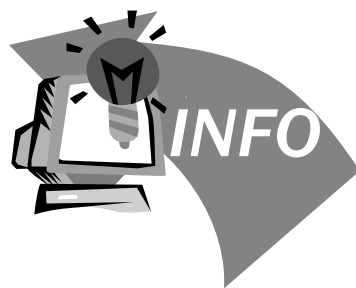

## Chapter 5 Troubleshooting

In this chapter, we will list some frequently encountered technical problems and tell you how to resolve them.



### 5.1 Frequently Asked Questions

- ❖ My computer switches to hibernation mode much too quickly, and I have to constantly hit a key or move the mouse to bring back the screen. What can I do?

This is part of Windows Power Management. Access Power Management by clicking on Start / Control Panel / Performance and Maintenance / Power Options, and change the time next to the "Turn off monitor" option to the time you want. You have the choice of either adjusting time for the power supply or for the battery.

- ❖ I've heard that cleaning and rearranging files on the hard drive will improve program's launch speed, how do I do this?

Good disk maintenances can improve program launch speed. This normally includes deleting unnecessary files, and defragmenting hard disk so that files can be more efficiently grouped. Windows contains maintenance utilities for these tasks; run Disk Cleanup to remove unnecessary files, and Disk Defragmenter to defragment fragmented file blocks. For more information about these utilities, please refer to your Windows documentation.

- ❖ The dial tone volume of the internal fax/modem is too low. How can I increase its volume?

Go to Start/Control Panel/Sounds, Speech, and Audio Devices,

under Device volume, adjust your speaker volume by controlling the volume bar.

- ❖ What kind of external microphone can I use with my notebook computer?

You will need to use a self-amplifying microphone.

- ❖ There are echoes coming from my speakers. What can I do?

Double click on the Speaker icon on the task bar. Then, under Microphone Balance, check the Mute box.

- ❖ Because of a software problem, I was unable to shut the computer down from Windows, I pressed the power button to power off the computer, but it didn't work. How can I force a power off?

Make sure you press the power button for at least 4 seconds. Normally, this will force the computer to shut off.

- ❖ Why can't I charge the battery of my portable computer after it was out of use for some time?

After your portable computer has not been used for a long time (say: more than one month), the battery will enter into low voltage protection mode. Under this circumstance, restoring to normal voltage will require the battery to be slowly charged for several hours. Once the battery has been fully charged, your

computer will resume to normal operation.

### ❖ My computer says: “CMOS Battery Low”, what should I do?

If your computer is without power (i.e. unplug the computer power source from the power outlet and remove the battery pack from it) for over 45 days, you would lose the information stored in CMOS.

Please follow the steps below to reconfigure your CMOS settings:

1. Press F2 to enter into the BIOS setup utility.
2. Select “Load Optional Defaults?”. When you see the following prompt, choose <OK> and then press <Enter>.
3. Select “Save Changes and Exit”, select <OK> and press <Enter> to restart your computer.

### ❖ How to unplug or eject devices

1. In the notification area next to your task bar, double-click the Safe Removal icon. Safe Removal displays a list of Plug and Play devices that support safe removal and that are currently attached to the system.

If you do not see the Safe Removal icon, your device does not support safe removal, and you cannot unplug or eject your device using Safe Removal.

2. In Safely Remove Hardware, in the list of devices, select the device that you want to unplug or eject, and then click Stop. This tells the system that you will be unplugging or ejecting the device.

3. In Stop a Hardware device, click OK.

A notification appears stating that it is now safe to unplug or eject the device.

#### Caution

•Unplugging or ejecting a device that supports safe removal without first using the Safe Removal application to warn the system can cause data to be lost or your system to become unstable. For example, if a device is unplugged during a data transfer, data loss is likely. If you use Safe Removal, however, you can warn the system before you unplug or eject a device, preventing possible loss of data.

#### Note

•For removable storage devices that can safely be removed while the system is on, the system disables write caching by default. It does this so the devices can be removed without loss of data. When write caching is disabled, however, the system will likely experience slower performance, so be sure to enable write caching when you have finished removing the device.



## Appendix A Specifications

This appendix lists technical and hardware specifications of your W251U notebook computer. Please note that the information mentioned here may not completely match your notebook computer's actual specifications. Specification is subject to change without notice, and the present manual may be modified at a later time.

**Microprocessor**

- Intel® Yonah® Dual Core Processor T2300~2700
- Intel® Celeron® M Processor 410~430

**L2 Cache**

- Intel® Yonah® Dual Core Processor T2300~2700 (L2 cache 2MB)
- Intel® Celeron® M Processor 410~430 (L2 cache 1MB)

**Core Logic**

- Intel® 945GM/ ICH7-M

**Memory**

- 256MB to maximum 2GB 533/667MHz DDR2 SDRAM with two SO-DIMM memory sockets
- 1 MB flash ROM BIOS

**Data Storage**

- 2.5", 9.5mm, SATA hard disk, 5400 rpm, available in 40GB/60GB/80GB/100GB
- One modularized 5.25"/12.7mm slim DVD-COMBO/DVD-Dual/Super Multi
- 4-in-1 SD/ MMC/ MS/ MSPRO Card Reader

**Display and Video**

- 12.1" TFT-LCD, WXGA (1280x800), Glare Type
- Simultaneous LCD and CRT display support
- Dual independent display

**Connectivity**

- Intergrated 10/100 Mbps Fast Ethernet connection
- Build-in 56Kbps V.92 fax/data modem
- Four Universal Serial Bus (USB) 2.0 ports

- Dual band antenna WLAN Intel® PRO/Wireless 3945ABG, IEEE 802.11a+b+g (Option)

**Audio**

- Built-in High Definition Audio (Alzalia)
- Built-in two stereo speakers Dual Array Microphone
- Separate audio ports for headphone-out and microphone-in devices

**Keyboard and pointing devices**

- 86-key US/87-key EU/90-key JP with Windows function keys
- Ergonomically-centered touchpad pointing device with scroll function

**I/O ports**

- One integrated camera 1.3 megapixel
- One IEEE 1394 Port
- One RJ-11 phone jack (V.92, 56Kbps modem)
- One RJ-45 network jack
- One DC-in jack (AC adapter)
- One VGA port
- One speaker/headphone-out jack (3.5mm mini jack)
- One MIC-in jack (3.5mm mini jack)
- Four USB 2.0 ports
- One PCI Express Card
- One S-Video Port

**Dimensions and Weight (with battery and optical drive)**

- 12.1" display model: about 1.75 Kg
- 299(W)x220(D)x24~32(H) mm

Power: 65W AC adapter 20V 3.25A



## Appendix B Service Centers

This appendix will list our global service centers for your W251U notebook computer.

**Taiwan ( Headquarters ) GIGA-BYTE TECHNOLOGY CO., LTD.**

Address: No.6, Bau Chiang Road, Hsin-Tien, Taipei 231, Taiwan  
 TEL: +886 (2) 8912-4888  
 FAX: +886 (2) 8912-4004

How to submit a question?

Technical            Issues about using GIGABYTE products.  
 Non-technical      Sales and marketing issues

WEB Address(English): <http://www.gigabyte.com.tw/>  
 WEB Address(Chinese): <http://chinese.giga-byte.com/>

**U.S.A. G.B.T. INC.**

TEL: +1 (626) 854-9338  
 FAX: +1 (626) 854-9339  
 WEB Address: <http://www.giga-byte.com/>

**Germany G.B.T. TECHNOLOGY TRADING GMBH**

TEL: +49-40-2533040 (Sales)    +49-1803-428468 (Tech.)  
 FAX: +49-40-25492343 (Sales)    +49-1803-428329 (Tech.)  
 WEB Address: <http://www.gigabyte.de/>

**Japan NIPPON GIGA-BYTE CORPORATION**

TEL: +81-3-5791-5438  
 FAX: +81-3-5791-5439  
 WEB Address: <http://www.gigabyte.co.jp/>

**China G.B.T. TECH. TRADING CO., LTD.**

Shanghai  
 TEL: +86-21-63410999  
 FAX: +86-21-63410100  
 WEB Address: <http://www.gigabyte.com.cn/>

GuangZhou  
 TEL: +86-20-87586074  
 FAX: +86-20-85517843  
 WEB Address: <http://www.gigabyte.com.cn/>

Beijing  
 TEL: +86-10-62102838  
 FAX: +86-10-62102848  
 WEB Address: <http://www.gigabyte.com.cn/>

Chengdu  
 TEL: +86-28-85236930  
 FAX: +86-28-85256822  
 WEB Address: <http://www.gigabyte.com.cn/>

Wuhan  
 TEL: +86-27-87851061  
 FAX: +86-27-87851330  
 WEB Address: <http://www.gigabyte.com.cn/>

Xian  
 TEL: +86-29-85531943  
 FAX: +86-29-85539821  
 WEB Address: <http://www.gigabyte.com.cn/>

Shenyang  
 TEL: +86-24-23960918  
 FAX: +86-24-23960918-809  
 WEB Address: <http://www.gigabyte.com.cn/>

U.K. G.B.T. TECH. CO., LTD.

TEL: +44-1908-362700 FAX: +44-1908-362709

WEB Address: <http://uk.giga-byte.com/>

Australia GIGABYTE TECHNOLOGY PTY. LTD.

TEL: +61 3 85616288 FAX: +61 3 85616222

WEB Address: <http://www.giga-byte.com.au/>

Singapore GIGABYTE SINGAPORE PTE. LTD.

WEB Address: <http://www.gigabyte.com.sg/>

The Netherlands GIGA-BYTE TECHNOLOGY B.V.

TEL: +31 40 290 2088 FAX: +31 40 290 2089

WEB Address: <http://www.giga-byte.nl/>

France GIGABYTE TECHNOLOGY FRANCE S.A.R.L.

Add: 47 allée des impressionnistes, immeuble Gauguin- 93420 Vil-  
lepinle (France) TEL: +800 44422983 (+800 GIGABYTE)

WEB Address: <http://www.gigabyte.fr/>

Russia Moscow Representative Office Of Giga-Byte Technol-  
ogy Co., Ltd.

WEB Address: <http://www.gigabyte.ru/>

Poland Office of GIGA-BYTE TECHNOLOGY Co., Ltd. in  
POLAND

WEB Address: <http://www.gigabyte.pl/>

Czech Republic Representative Office Of GIGA-BYTE Tech-  
nology Co., Ltd. in CZECH REPUBLIC

WEB Address: <http://www.gigabyte.cz/>

Romania Representative Office Of GIGA-BYTE Technology  
Co., Ltd. in Romania

WEB Address: <http://www.gigabyte.com.ro/>

Serbia & Montenegro Representative Office Of GIGA-BYTE  
Technology Co., Ltd. in SERBIA & MONTENEGRO

WEB Address: <http://www.gigabyte.co.yu/>