

6BX7+

USER'S MANUAL

1. **Support Suspend To RAM Function.**
2. **CPU Over Voltage Select (Magic Booster).**
3. **Support Dual BIOS and BIOS Write Protection.**
4. **System power on by PS/2 Mouse: First, enable this function in CMOS Setup, then you can power on the system by double clicking the right or left button of your PS/2 Mouse.**
5. **System power on by Keyboard: If your ATX power supply supports 300 mA 5V Stand-By current (depends on the specification of keyboards) , you can power on your system by entering password from the keyboard after setting the "Keyboard power on" password in CMOS Setup.**
6. **Supports 3 steps ACPI LED.**
7. **Modem Ring-On (COM A , B).**
8. **Wake-Up on LAN (The ATX power supply supports larger than 720 mA 5V Stand-By current).**

Celeron™/Pentium®!!! Socket 370 Processor MAINBOARD
REV. 1.1 First Edition
R-11-01-000417

The author assumes no responsibility for any errors or omissions which may appear in this document nor does it make a commitment to update the information contained herein.

Third-party brands and names are the property of their respective owners.

Sound Blaster is a registered trademark of Creative Technology Ltd in the United States and certain other countries. Sound Blaster-LINK and SB-LINK are trademarks of Creative Technology Ltd.

I. Quick Installation Guide :

CPU SPEED SETUP

The system bus speed is selectable at 66 and 100 MHz. The user can select the system bus speed and change the DIP SWITCH (**SW**) selection to set up the CPU speed for 233 - 800MHz processor.

Pentium Celeron / !!! CPU	1	2	3	4	5	6	7	8
300 / 66MHz	OFF	ON	OFF	ON	ON	OFF	OFF	ON
333 / 66MHz	ON	OFF	OFF	ON	ON	OFF	OFF	ON
366 / 66MHz	OFF	OFF	OFF	ON	ON	OFF	OFF	ON
400 / 66MHz	ON	ON	ON	OFF	ON	OFF	OFF	ON
433 / 66MHz	OFF	ON	ON	OFF	ON	OFF	OFF	ON
466 / 66MHz	ON	OFF	ON	OFF	ON	OFF	OFF	ON
500 / 66MHz	OFF	OFF	ON	OFF	ON	OFF	OFF	ON
533 / 66MHz	ON	ON	OFF	OFF	ON	OFF	OFF	ON
* 566 / 66MHz	OFF	ON	OFF	OFF	ON	OFF	OFF	ON
500 / 100MHz	ON	OFF	OFF	ON	OFF	OFF	OFF	OFF
550 / 100MHz	OFF	OFF	OFF	ON	OFF	OFF	OFF	OFF
600 / 100MHz	ON	ON	ON	OFF	OFF	OFF	OFF	OFF
650 / 100MHz	OFF	ON	ON	OFF	OFF	OFF	OFF	OFF
700 / 100MHz	ON	OFF	ON	OFF	OFF	OFF	OFF	OFF
750 / 100MHz	OFF	OFF	ON	OFF	OFF	OFF	OFF	OFF
800 / 100MHz	ON	ON	OFF	OFF	OFF	OFF	OFF	OFF
* 850 / 100MHz	OFF	ON	OFF	OFF	OFF	OFF	OFF	OFF

★ We don't recommend you to setup your CPU ratio above 8 nth, it doesn't support now.

Main Clock Table				
CLK	5	6	7	8
66 MHz	ON	OFF	OFF	ON
152 MHz	ON	OFF	ON	OFF
142MHz	ON	ON	OFF	OFF
100 MHz	OFF	OFF	OFF	OFF
112MHz	OFF	OFF	ON	OFF
124 MHz	OFF	ON	ON	OFF
133 MHz	OFF	ON	OFF	OFF
PCI Run 44.3 MHz				
133 MHz	ON	ON	ON	OFF
PCI Run 33.3 MHz				

★ Note: We don't recommend you to setup your system speed to 152, 142, 112, 124 or 133MHz because these frequencies are not the standard specifications for CPU, Chipset and most of the peripherals. Whether your system can run under 152, 142, 112, 124 or 133MHz properly will depend on your hardware configurations: CPU, SDRAM, Cards, etc.

Frequency Table:

FREQ. RATIO	DIP SWITCH (SW)			
	1	2	3	4
X 3	ON	OFF	ON	ON
X 3.5	OFF	OFF	ON	ON
X 4	ON	ON	OFF	ON
X 4.5	OFF	ON	OFF	ON
X 5	ON	OFF	OFF	ON
X 5.5	OFF	OFF	OFF	ON
X 6	ON	ON	ON	OFF
X 6.5	OFF	ON	ON	OFF
X 7	ON	OFF	ON	OFF
X 7.5	OFF	OFF	ON	OFF
X 8	ON	ON	OFF	OFF
X 8.5	OFF	ON	OFF	OFF
X 9	ON	OFF	OFF	OFF
X 9.5	OFF	OFF	OFF	OFF

★ We don't recommend you to setup your CPU ratio above 8 nth, it doesn't support now.

1. Pentium Celeron™ 300A / 66 MHz FSB

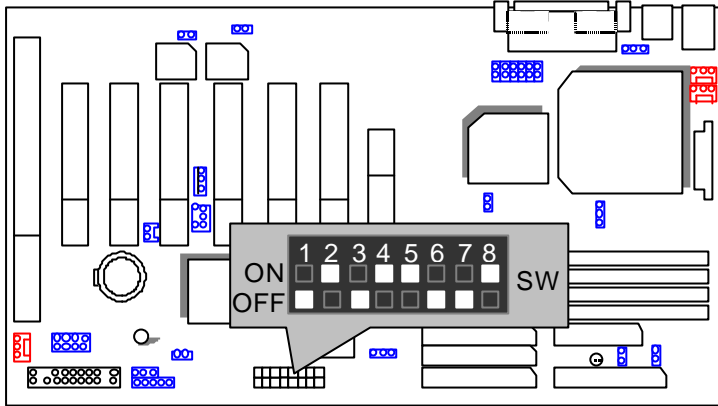

2. Pentium Celeron™ 333 / 66 MHz FSB

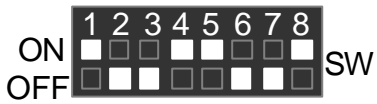

3. Pentium Celeron™ 366 / 66MHz FSB

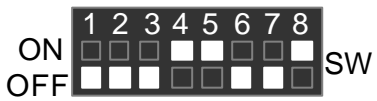

4. Pentium Celeron™ 400 / 66MHz FSB

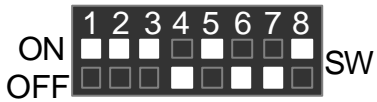

5. Pentium Celeron™ 433 / 66MHz FSB

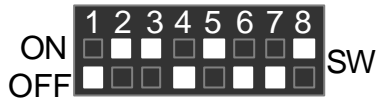

6. Pentium Celeron™ 466 / 66MHz FSB

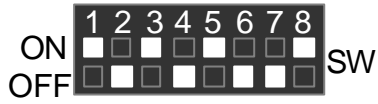

7. Pentium Celeron™ 500 / 66MHz FSB

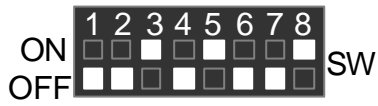

8. Pentium Celeron™ 533 / 66MHz FSB

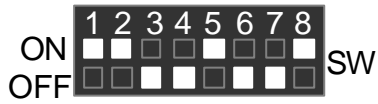

- ★ 9. Pentium Celeron™ 566 / 66MHz FSB (Reserve)

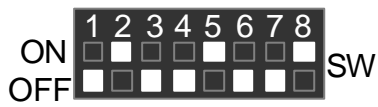

10. Pentium® !!! 500 / 100 MHz FSB

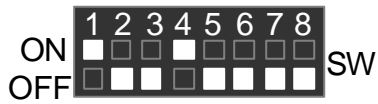

11. Pentium® !!! 550 / 100 MHz FSB

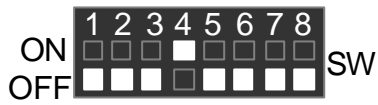

12. Pentium® !!! 600 / 100 MHz FSB

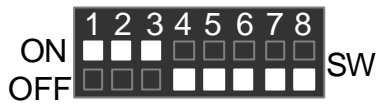

13. Pentium® !!! 650 / 100 MHz FSB

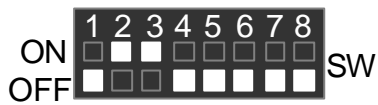

14. Pentium® !!! 700 / 100 MHz FSB

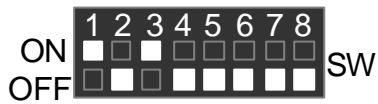

15. Pentium® !!! 750 / 100 MHz FSB

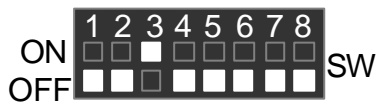

16. Pentium® !!! 800 / 100 MHz FSB

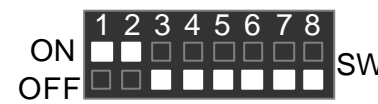

★ 17. Pentium® !!! 850 / 100 MHz FSB (Reserve)

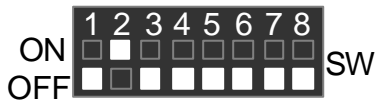

II. Jumper setting :

SPK : External Speaker/ Internal Buzzer Connector

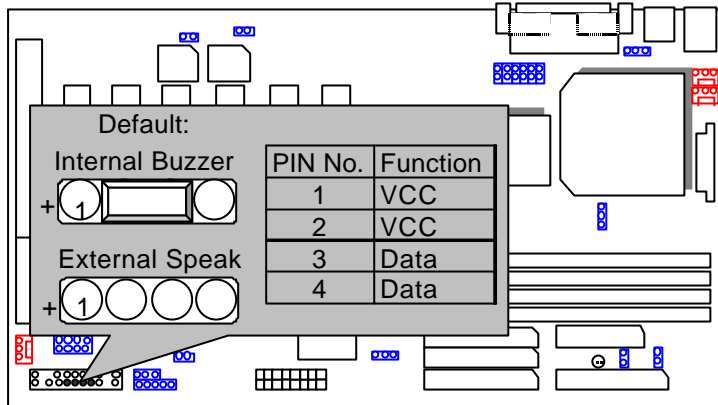

RST : Reset Switch

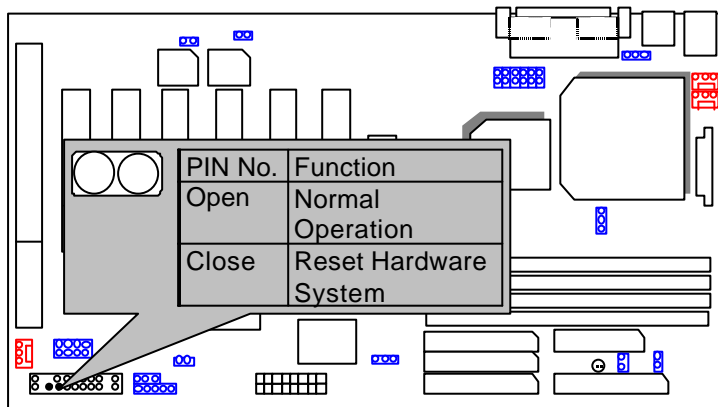

PW LED : Power LED Connector

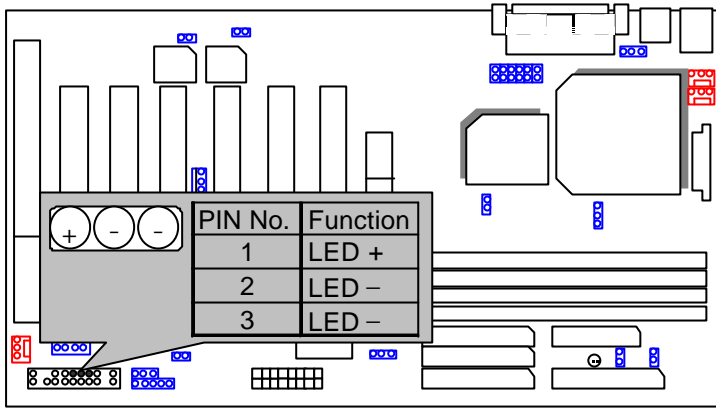

HD : IDE Hard Disk Active LED

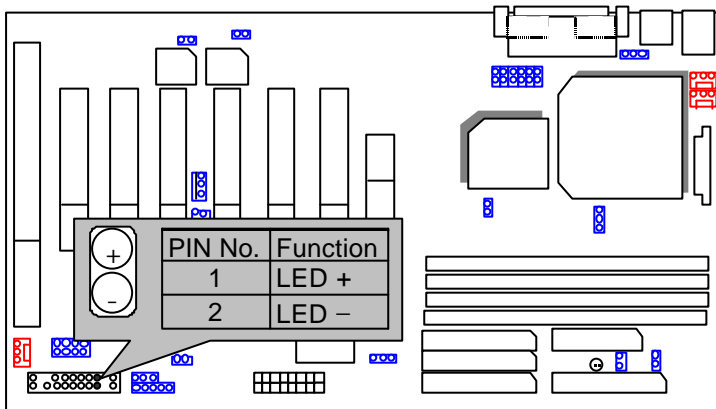

JP9 : IR(Infrared Connector) (Optional)

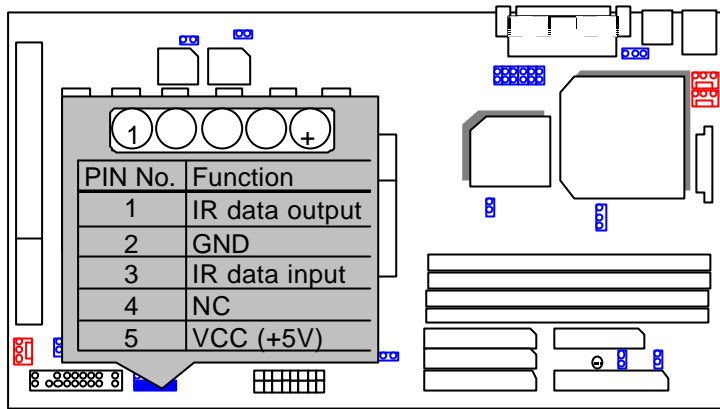

GN : Green Function Switch

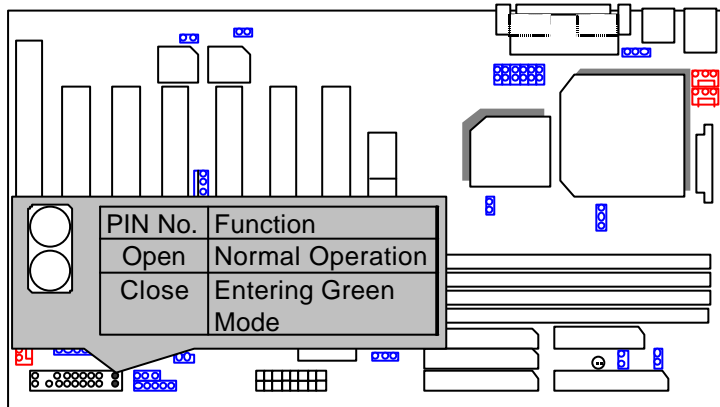

GD : Green LED

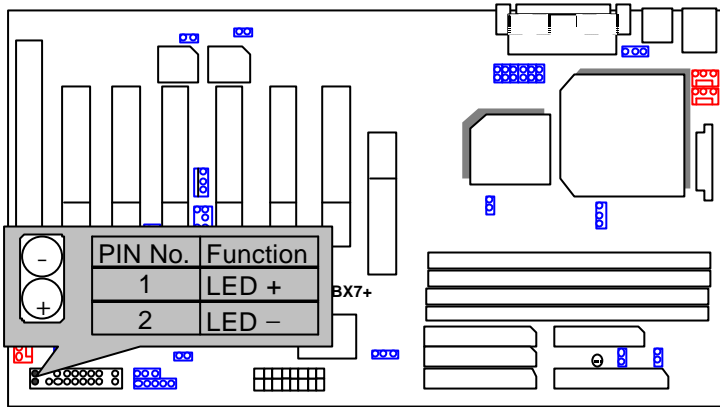

Soft Power : Soft Power Connector

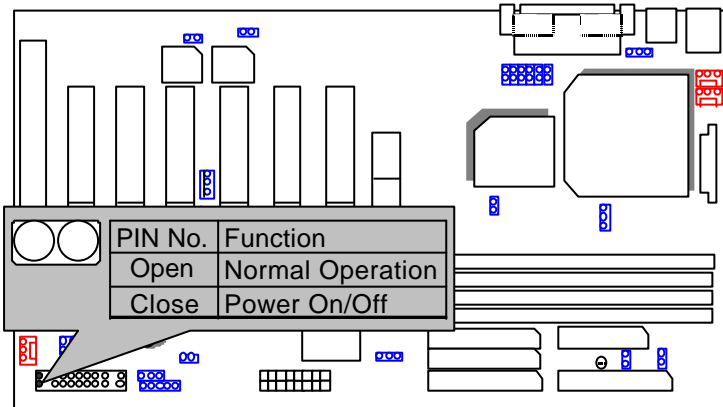

ATX POWER : ATX Power Connector

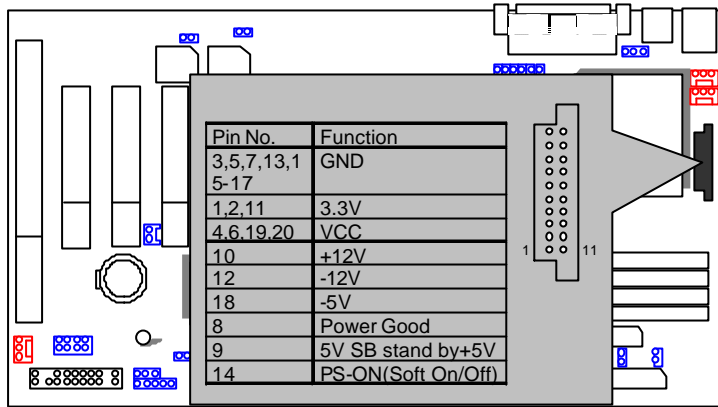

PS/2 Mouse / Keyboard Connector

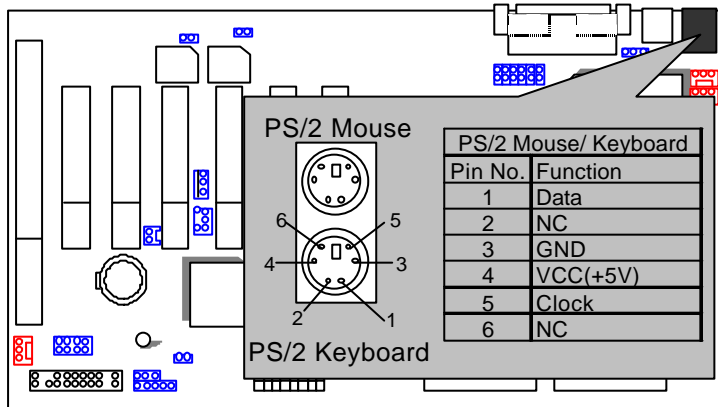

USB : USB Port

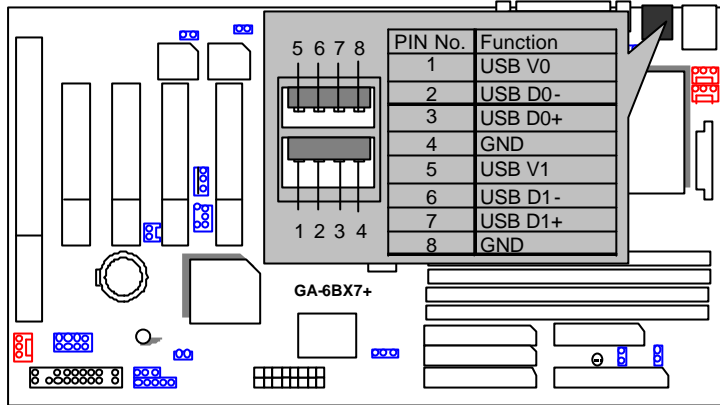

J1 : CPU Fan Connector

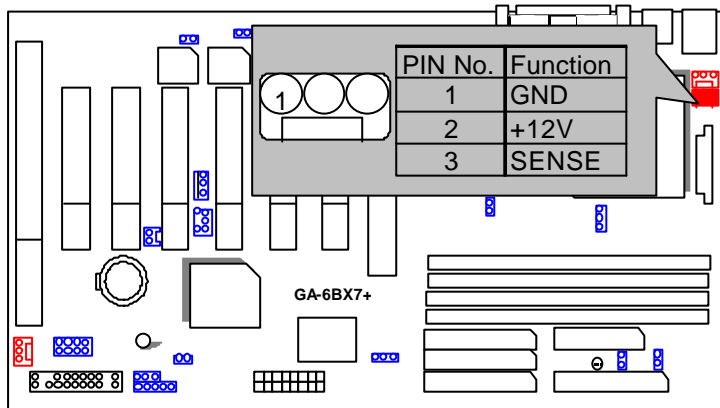

J16 : Power Fan Connector

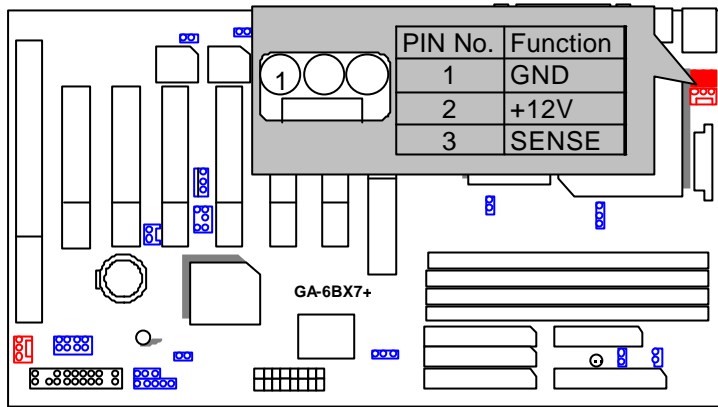

J17 : Panel (System) Fan Connector

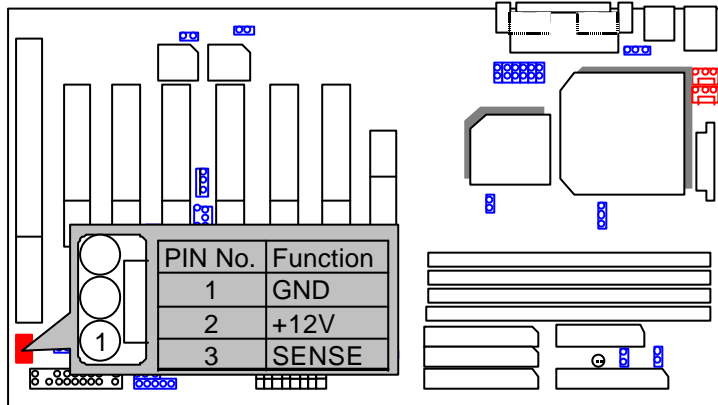

IDE1 : For Primary IDE Port

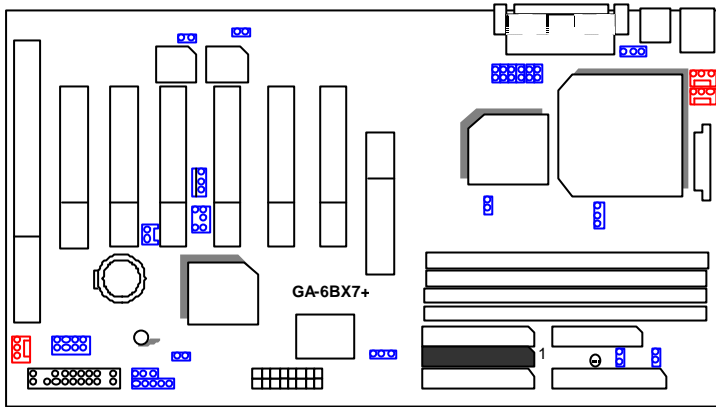

IDE2 : For Secondary IDE Port

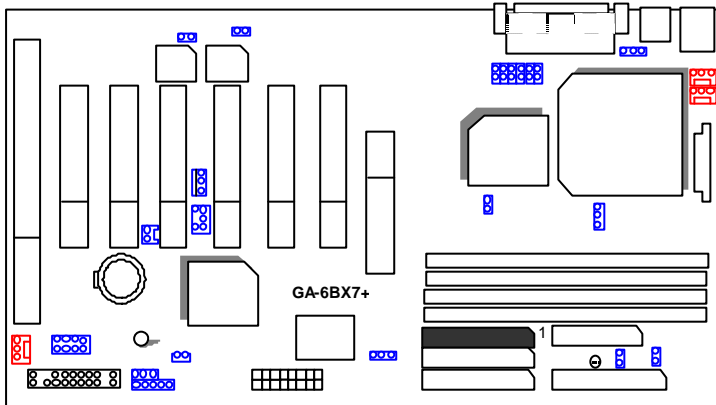

ULTRA66-1 : For Ultra66 Primary IDE Port

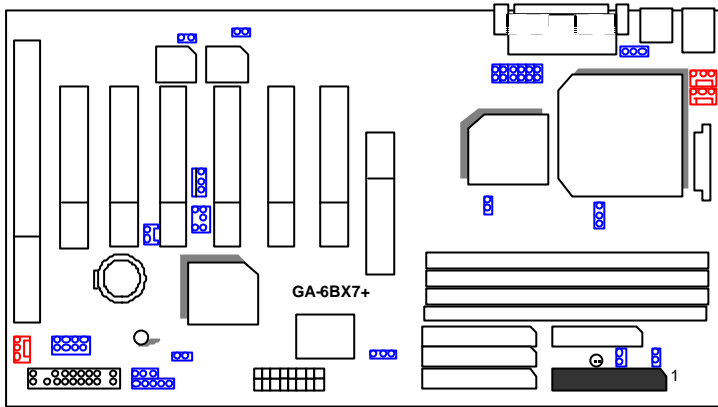

ULTRA66-2 : For Ultra66 Secondary IDE Port

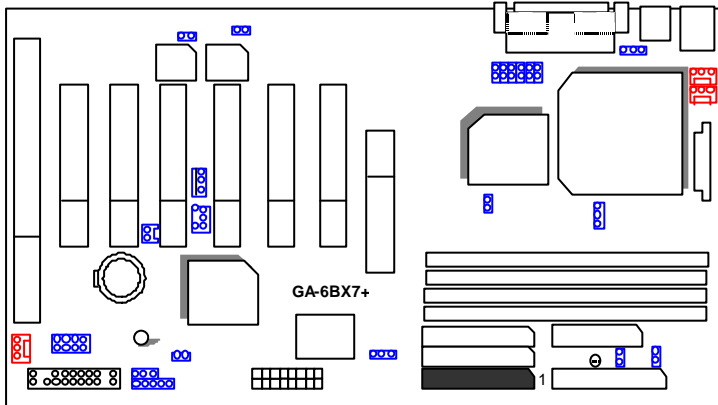

JP4 : ATA66 Disable / Enable

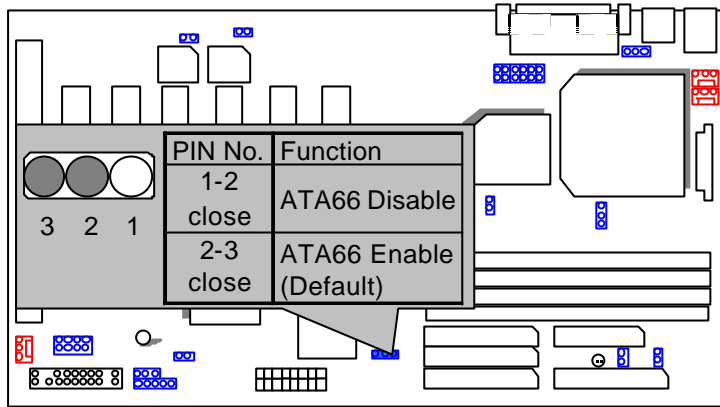

FLOPPY : Floppy Port

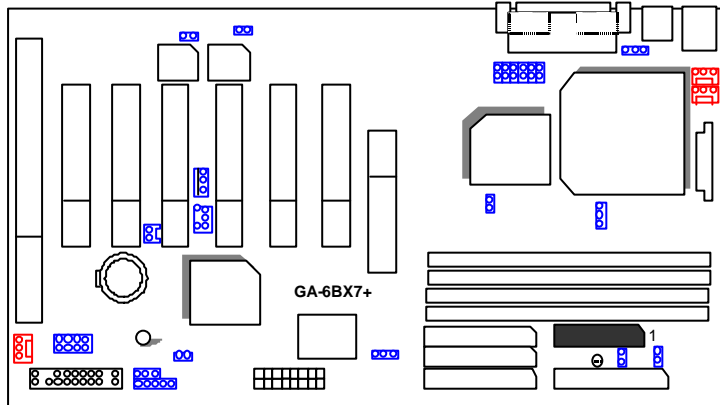

LPT PORT / COM A / COM B

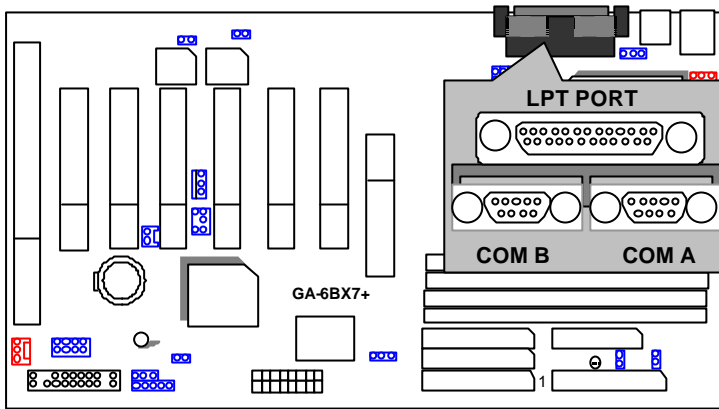

JP1 : PS/2 Keyboard Power On Selection

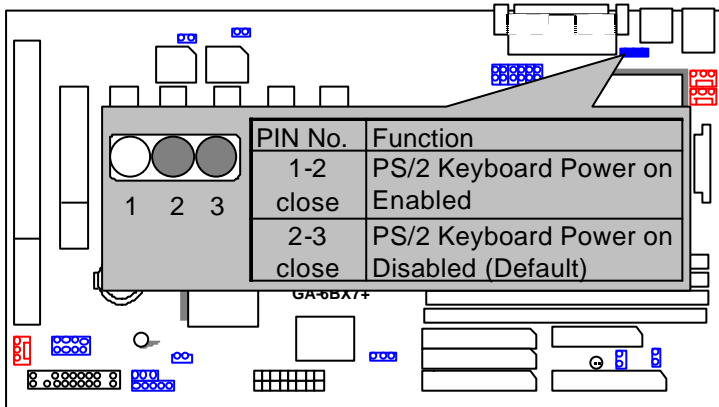

J15 : System After AC Back

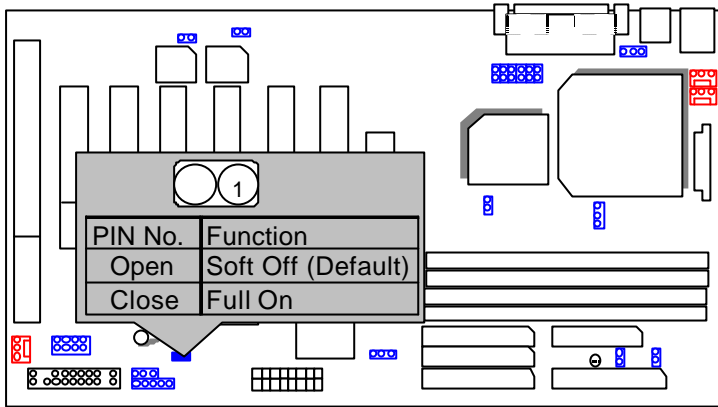

JP7 : Wake On LAN

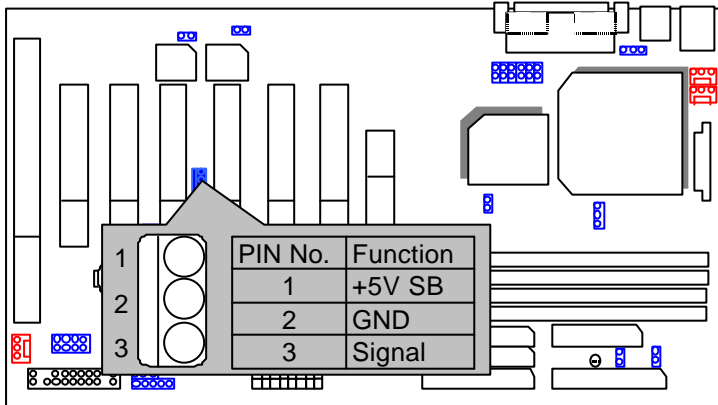

JP8 : SB-LINK ,For PCI Sound Card Support (Optional)

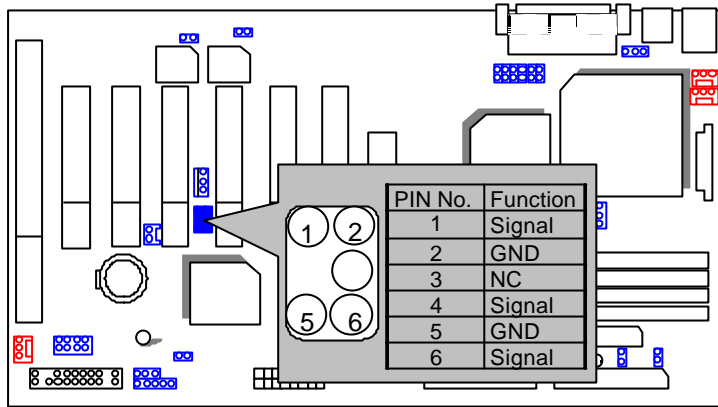

JP12 : Case Open

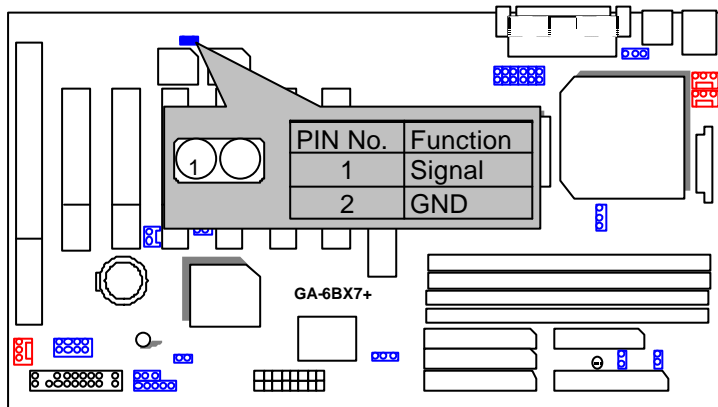

JP14 : Clear CMOS Function

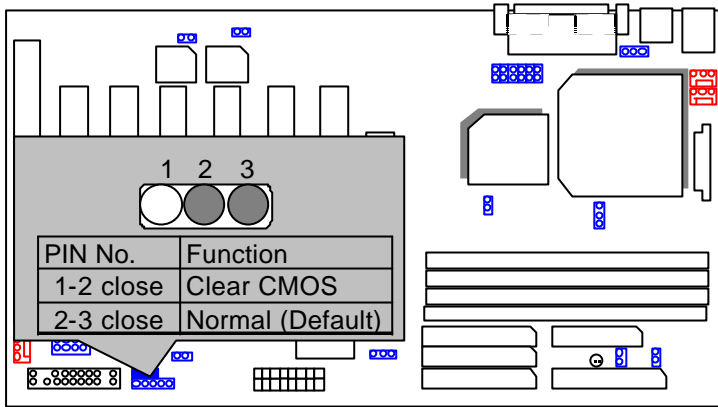

JP13 / JP17 : Close STR Enable

(If you want to use STR Function, please set jumper JP13 & JP17 Closed.)

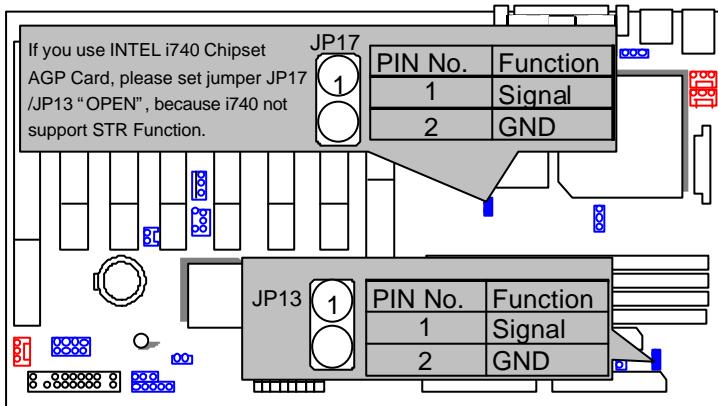

JP16 : STR LED Connector & DIMM LED

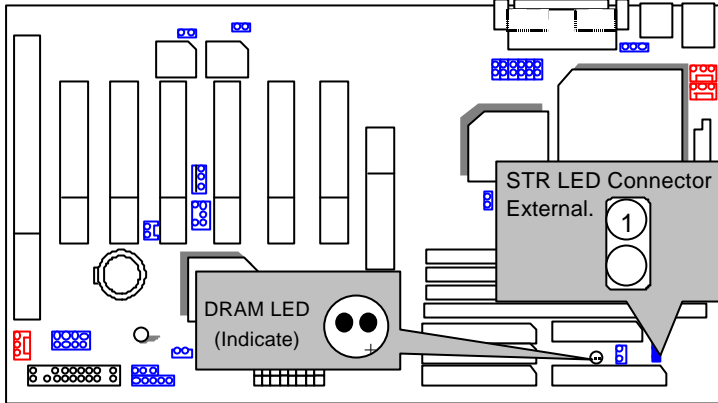

J18 : Ring POW On: Internal Modem Ring Power On

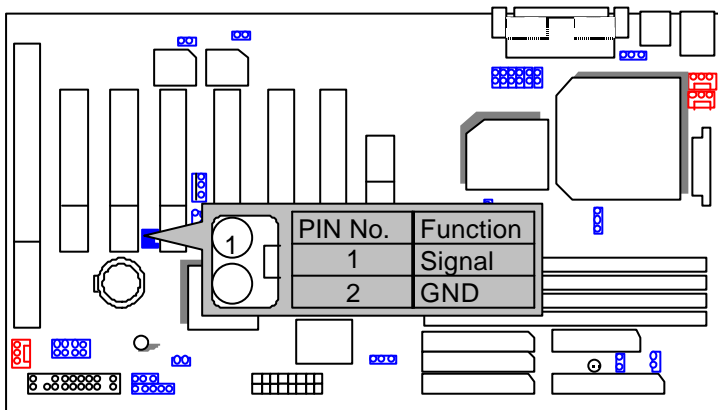

JP22 : BIOS Flash ROM Write Protection

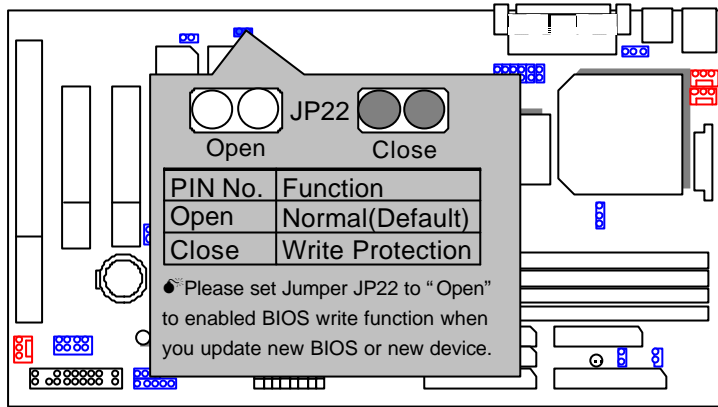

T3 : FPUSB

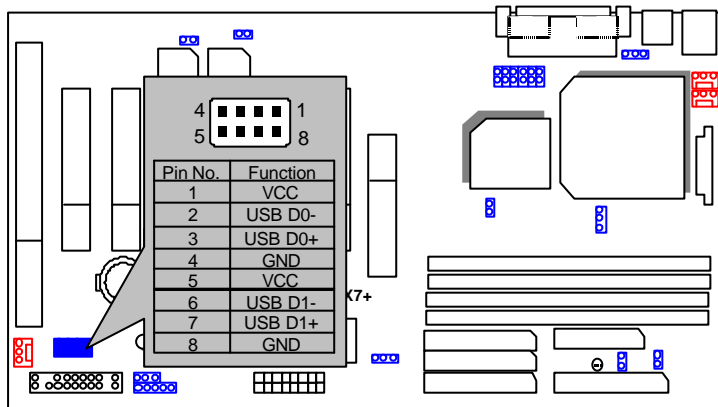

JP3 : CPU Over Voltage Select (**Magic Booster**)

(When JP3 3-4 Pin set "close", CPU Voltage is rising 10%)

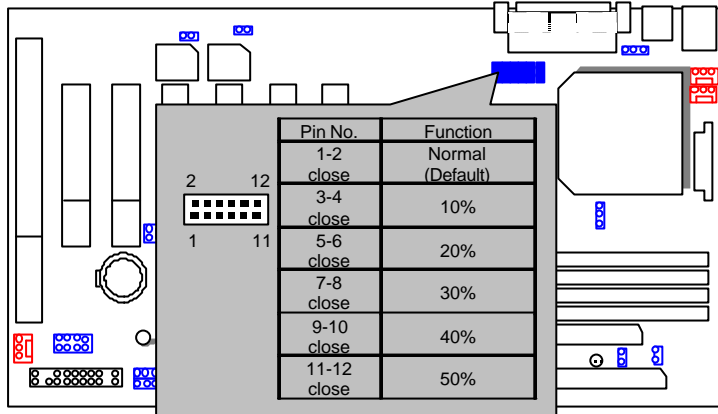

JP24 : System Acceleration

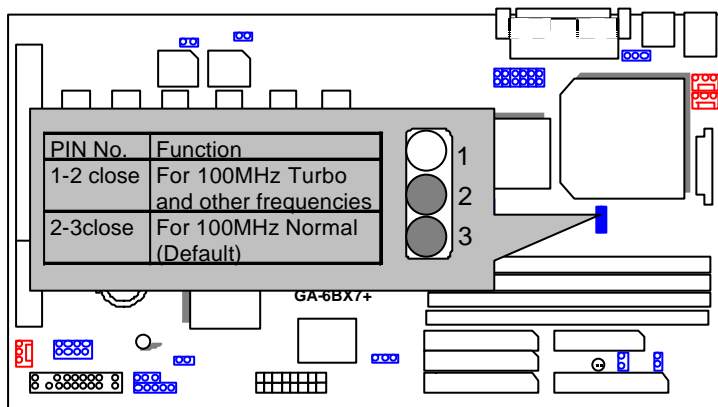

BAT1:Battery

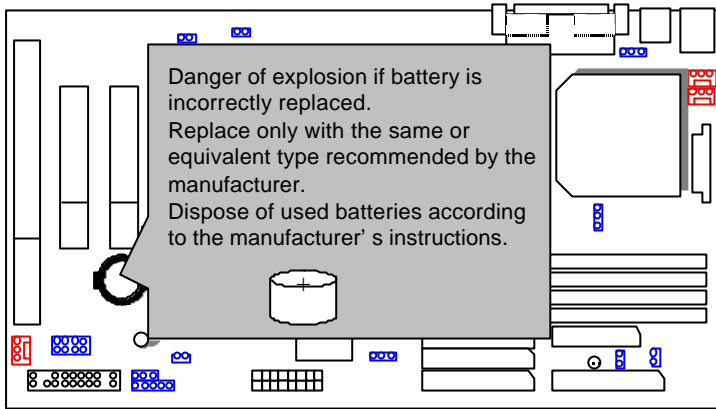

III. Top Performance Test Setting:

The following performance data list is the testing results of some popular benchmark testing programs.

Users have to modify the value for each item in chipset features as follow for top performance setting.

ROM PCI/ISA BIOS (2A69K60E)			
CHIPSET FEATURES SETUP			
AWARD SOFTWARE, INC.			
Reset Case Open Status	: No	EDO CAS:# MA Wait State	: 1
Case Opened	: No	EDO RAS:# Wait State	: 1
Slow Down CPU Duty Cycle	: Normal	SDRAM CAS Latency Time	: 2
Shutdown Temp.(°C/°F)	: 75°C/167°F	DRAM Data Integrity Mode	: Non-ECC
* Temp. Select (°C/°F)		BIOS Flash Protection	: Disabled
CPU : 70°C/158°F		System BIOS Cacheable	: Enabled
* Temperature Alarm		Video BIOS Cacheable	: Enabled
CPU : No		Video RAM Cacheable	: Disabled
* Current Temp.(°C/°F)		16Bit I/O Recovery Time	: 1
CPU : 33/91		Memory Hole At 15M-16M	: Disabled
* Fan Fail Alarm		Delayed Transaction	: Disabled
CPU:No POWER:No PANEL:No		Clock Spread Spectrum	: Disabled
* Current Fan Speed (RPM)			
CPU:5443 POWER:0 PANEL:0			
* Current Voltage (V)			
VCOREA:1.95 VGTL : 1.52 UCC3:3.36		ESC : Quit	↑↓↓↑ : Select Item
+ 5V: 5.08 +12V: 12.52 -12V: 41.86		F1 : Help	PU/PD/+/- : Modify
- 5V: - 5.09 VBAT: 3.28 5VSB:5.05		F5 : Old Values (Shift)F2 : Color	
		F6 : Load BIOS Defaults	
		F7 : LOAD PERFORMANCE DEFAULTS	

These data are just referred by users, and there is no responsibility for different testing data values gotten by users. (Different Hardware & Software configuration will result in different benchmark testing results.)

- CPU Intel Socket 370 Pentium® !!! 800EB MHz processor
- DRAM (256x1) MB MOSEL 9923PR V54C328804VCT75)
- CACHE SIZE 256 KB included in CPU
- DISPLAY GA-660Plus AGP Card
- STORAGE Onboard Promise IDE (Quantum KA13600AT)
- O.S. Windows NT™4.0 SPK6a
- DRIVER Display Driver at 1024 x 768 x 65536 colors x 75Hz.
Promise Ultra Driver (ver.1.44 Build:0728)

Processor	Intel Pentium® !!! Socket 370 800EB MHz (100 x 8.0)
Winbench99	
CPU mark99	72
FPU Winmark99	4250
Business Disk Winmark99	5820
Hi-End Disk Winmark99	14000
Business Graphics Winmark99	393
Hi-End Graphics Winmark99	738
Winstone99	
Business Winstone99	44.2
Hi-End Winstone99	47.9

IV. Suspend to RAM Installation

A.1 Introduce STR function:

Suspend-to-RAM (STR) is a Windows 98 ACPI sleep mode function. When recovering from STR (S3) sleep mode, the system is able, in just a few seconds, to retrieve the last "state" of the system before it went to sleep and recover to that state. The "state" is stored in memory (RAM) before the system goes to sleep. During STR sleep mode, your system uses only enough energy to maintain critical information and system functions, primarily the system state and the ability to recognize various "wake up" triggers or signals, respectively.

A.2 STR function Installation

Please use the following steps to complete the STR function installation.

Step-By-Step Setup

Step 1:

To utilize the STR function, the system must be in Windows 98 ACPI mode.

Putting Windows 98 into ACPI mode is fairly easy.

Setup with Windows 98 CD:

- A. Insert the Windows 98 CD into your CD-ROM drive, select Start, and then Run.
- B. Type (without quotes) "**D:\setup /p j**" in the window provided. Hit the enter key or click OK.
¶ In Windows 98 second edition version, all the bios version dated 12/01/99 or later are ACPI compatible. Just type "D:\Setup", the operating system will be installed as ACPI mode. ¶
- C. After setup completes, remove the CD, and reboot your system
(This manual assumes that your CD-ROM device drive letter is D:).

Step 2:

To use STR Function, you will need to set motherboard jumpers JP13 & JP17 closed per the figure below (i.e., put a jumper over both pins at each location).

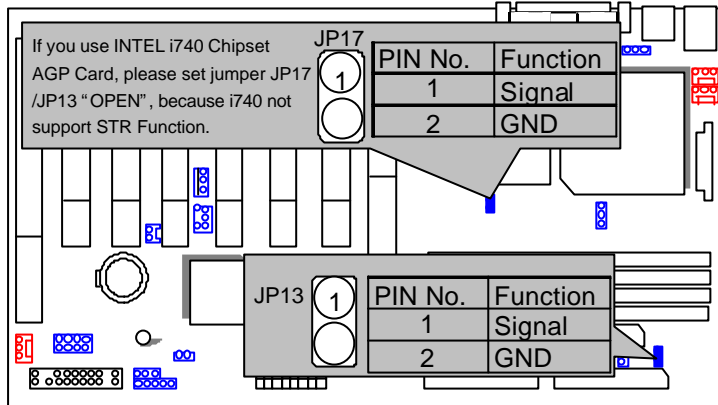

Step 3:

Power on the computer and as soon as memory counting starts, press . You will enter BIOS Setup. Select the item "**POWER MANAGEMENT SETUP**", then select "**ACPI Suspend Type: Suspend to RAM**". Remember to save the settings by pressing "ESC" and choose the "**SAVE & EXIT SETUP**" option.

Congratulation! You have completed the installation and now can use the STR function.

A.3 How to put your system into STR mode?

There are two ways to accomplish this:

1. Choose the "Stand by" item in the "Shut Down Windows" area.

- A. Press the "Start" button and then select "Shut Down"



- B. Choose the "Stand by" item and press "OK"

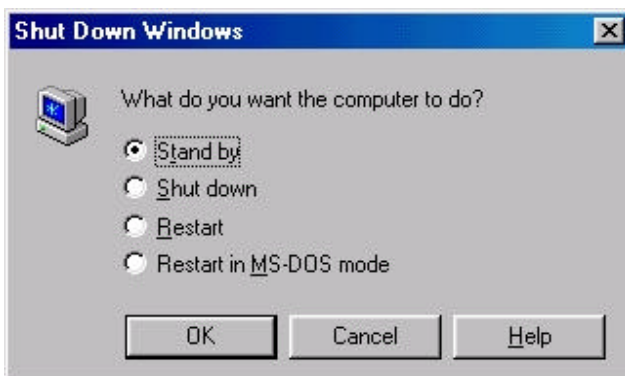

2. Define the system "power on" button to initiate STR sleep mode:

A. Double click "My Computer" and then "Control Panel"



B. Double click the " Power Management" item.

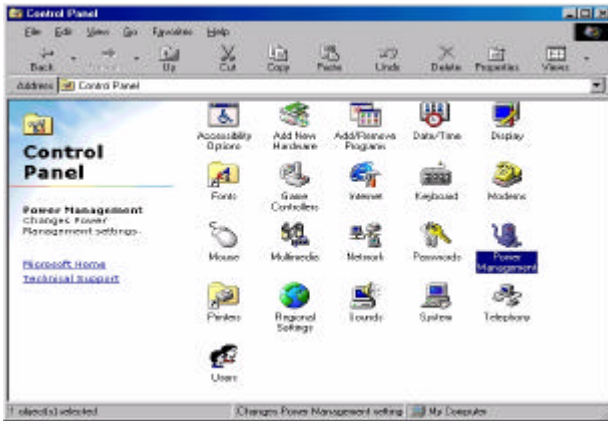

C. Select the “Advanced” tab and “Standby” mode in Power Buttons.

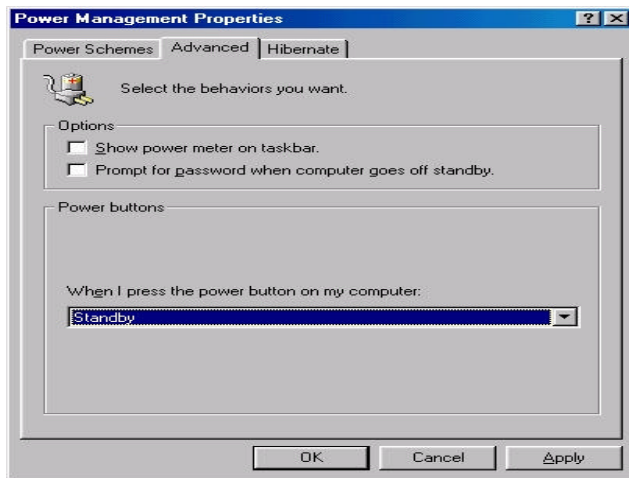

Step 4:

Restart your computer to complete setup.

Now when you want to enter STR sleep mode, just momentarily press the “Power on” button..

A.4 How to recover from the STR sleep mode?

There are six ways to “wake up” the system:

1. Press the “Power On” button
2. Use the “PS/2 Keyboard Power On” function.
3. Use the “PS/2 Mouse Power On” function
4. Use the “Resume by Alarm” function
5. Use the “Modem Ring On” function
6. Use the “Wake On LAN” function.

A.5 Notices & Limitations:

1. In order for STR to function properly, several hardware and software requirements must be satisfied:

A. Your ATX power supply must comply with the ATX 2.01 specification (provide more than 720 mA 5V Stand-By current).

B. Your SDRAM must be PC-100 compliant.

2. Jumper JP16 is provided to connect to the STR LED in your system chassis. [Your chassis may not provide this feature.] The STR LED will be illuminated when your system is in STR sleep mode.

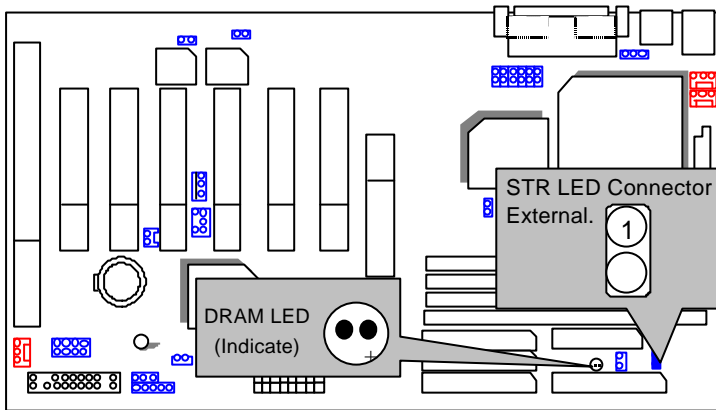

3. The following is a listing of popular peripherals which have been successfully tested, on an individual basis, to function correctly in an STR environment. NOTE: All combinations of these peripherals have NOT been tested and therefore we do not warrant any particular combination.

A. VGA Card:

(1)AGP:	Winfast L2300	Driver Ver.: 7-1-1998
(2)AGP:	ATI 3D RAGE Pro AGP 2X	Driver Ver.: 535
(3)AGP:	ATI RAGE TURBO AGP	Driver Ver.: 535
(4)AGP:	GA-600	Driver Ver.: win95.342

B. VGA +Sound Card:

(1) AGP:	Winfast L2300	Driver Ver.: 7-1-998
Sound:	Creative PCI64	Driver Ver.: 3-18-1998
(2) AGP:	ATI 3D RAGE Pro x2	Driver Ver.: 535
Sound:	Creative PCI64	Driver Ver.: 3-18-1998
(3) AGP:	ATI RAGE TURBO AGP	Driver Ver.: 535
Sound:	Creative PCI64	Driver Ver.: 3-18-1998
(4) AGP:	GA-600	Driver Ver.: win95.342
Sound:	Creative PCI64	Driver Ver.: 3-18-1998

C. VGA + LAN Card:

AGP Card:	Winfast L2300	Driver Ver.: 7-1-1998
	ATI 3D RAGE Pro AGP 2X	Driver Ver.: 535
	ATI RAGE TURBO AGP	Driver Ver.: 535
	GA-600	Driver Ver.: win95.342

LAN Card:

Driver Ver.:	Intel E100B(82557)	
	WIn98 embedded	
	Intel P1A8461(82558B)	Driver Ver.: WIn98 embedded
	Intel P1A8465(82558)	Driver Ver.: WIn98 embedded
	SMC9432TX	Driver Ver.: WIn98 embedded
	SMC EtherPower	Driver Ver.: WIn98 embedded
	D-Link DFE-500TX	Driver Ver.: WIn98 embedded
	D-Link DE-530CT	Driver Ver.: WIn98 embedded
	D-Link DE-220P	Driver Ver.: WIn98 embedded
	3COM 3C900	Driver Ver.: 10-29-1998
	3COM 3C905B-TX	Driver Ver.: 10-29-1998
	3COM 3C905	Driver Ver.: 10-29-1998
	Digital LMP100TX	Driver Ver.: WIn98 embedded
	Digital DE500-BA	Driver Ver.: WIn98 embedded
	Adaptec ANA-6911/TX	Driver Ver.: WIn98 embedded

D. VGA +Sound+LAN Card:

- | | |
|--------------------------------|-----------------------------|
| (1)AGP: Winfast L2300 | Driver Ver.: 7-1-1998 |
| Sound: | Creative PCI64 |
| Driver Ver.: | 3-18-1998 |
| LAN: Intel PILA8461(82558B) | Driver Ver.: WIn98 embedded |
| (2)AGP: Winfast L2300 | Driver Ver.: 7-1-1998 |
| Sound: | Creative PCI64 |
| Driver Ver.: | 3-18-1998 |
| LAN: Intel PILA8465(82558) | Driver Ver.: WIn98 embedded |
| (3)AGP: Winfast L2300 | Driver Ver.: 7-1-1998 |
| Sound: | Creative PCI64 |
| Driver Ver.: | 3-18-1998 |
| Lan: 3COM 3C905B-TX | Driver Ver.: 10-29-1998 |
| (4)AGP: ATi3D RAGE Pro AGP 2X | Driver Ver.: 535 |
| Sound: | Creative PCI64 |
| Driver Ver.: | 3-18-1998 |
| LAN: Intel PILA8461(82558B) | Driver Ver.: WIn98 embedded |
| (5)AGP: ATi 3D RAGE Pro AGP 2X | Driver Ver.: 535 |
| Sound: | Creative PCI64 |
| Driver Ver.: | 3-18-1998 |
| LAN: Intel PILA8465(82558) | Driver Ver.: WIn98 embedded |
| (6)AGP: ATi 3D RAGE Pro AGP 2X | Driver Ver.: 535 |
| Sound: | Creative PCI64 |
| Driver Ver.: | 3-18-1998 |
| LAN: 3COM 3C905B-TX | Driver Ver.: 10-29-1998 |
| (7)AGP: ATiRAGE TURBO AGP | Driver Ver.: 535 |
| Sound: | Creative PCI64 |
| Driver Ver.: | 3-18-1998 |
| LAN: Intel PILA8461(82558B) | Driver Ver.: WIn98 embedded |
| (8)AGP: ATiRAGE TURBO AGP | Driver Ver.: 535 |
| Sound: | Creative PCI64 |
| Driver Ver.: | 3-18-1998 |
| LAN: Intel PILA8465(82558) | Driver Ver.: WIn98 embedded |
| (9) AGP: | ATiRAGE TURBO AGP |
| Driver Ver.: | 535 |
| Sound: | Creative PCI64 |
| Driver Ver.: | 3-18-1998 |
| LAN: 3COM 3C905B-TX | Driver Ver.: 10-29-1998 |

E. SDRAM:

(1) SDRAM: Apacer (AM2V168A1T8)	32MB
(2) SDRAM: Trandscend (MITSUBISHI M5M4V16S30BTP-10)	32MB
(3) SDRAM: BUFFALO(NEC D4516821AG5-A10-75F)	32MB
(4) SDRAM: HYUNDAI (HYUNDIA 7V75A400 DTFG-10P)	32MB
(5) SDRAM: ATP (SEC KM48S2020CT-G8)	32MB
(6) SDRAM: CRUCIAL (MICRON MT48LC2M8A-8)	32MB
(7) SDRAM: BUFFALO (FUJITSU 81F16822D-102LFN M00)	32MB
(8) SDRAM: UMAX (MITSUBISHI M5M4V16S30DTP-8)	32MB
(9) SDRAM: UMAX (MITSUBISHI M5M4V16S30BTP-10)	32MB
(10) SDRAM: ARMAS (NEC D4564841G5-A10)	64MB
(11) SDRAM: SAMSUNG (SEC KM48S8030CT-GA)	64MB
(12) SDRAM: BUFFALO (MICRON MT48LC2M8A1-8)	64MB
(13) SDRAM: ADTEC (MITSUBISH M5M4V64S30ATP-8)	128MB
(14) SDRAM: (NEC D4564441G5-A10-9JF)	256MB

F. Power Supply:

Vender	Model	Spec.
(1). HIGH POWER	HPC-250G1 REV:A0-01	(5VSB 1A)
(2). PC WINNER	ST-235ATX	(5VSB 1.5A)
(3). Enhance	ATX725B	(5VSB 1A)
(4). Enhance	ATX723B	(5VSB 1A)
(5). Sseasanic	SS-200FS	(5VSB 1A)
(6). SPI	FSP-235-60GT	(5VSB 0.8A)
(7). ETASIS	EPR-2305	(5VSB 0.8A)
(8). DVE	DSP-ATX230	(5VSB 0.75A)

1. Limitation List:

- a. Don't get into STR mode right away when the system just resume from STR mode, Please wait a few seconds to let the system completely restore the last status' s data.
- b. SCSI HD devices are not supported for STR function for now on.
- c. If you use a ZIP of external connector type, please modify the item "Parallel Port Mode" of "INTEGRATED PERIPHERALS" in your BIOS setting to "ECP or ECP+EPP" mode.
- d. If your PS/2 Mouse fails in "Mouse Power On" function, please contact your vendor and update your Mouse Driver.

V. Introduce Dual BIOS

A. What is Dual BIOS Technology?

Dual BIOS means that there are two system BIOS (ROM) on the motherboard, one is the Main BIOS and the other is Backup BIOS. Under the normal circumstances, the system works on the Main BIOS. If the Main BIOS is corrupted or damaged, the Backup BIOS can take over while the system is powered on. This means that your PC will still be able to run stably as if nothing has happened in your BIOS.

B. How to use Dual BIOS?

a. Boot Screen

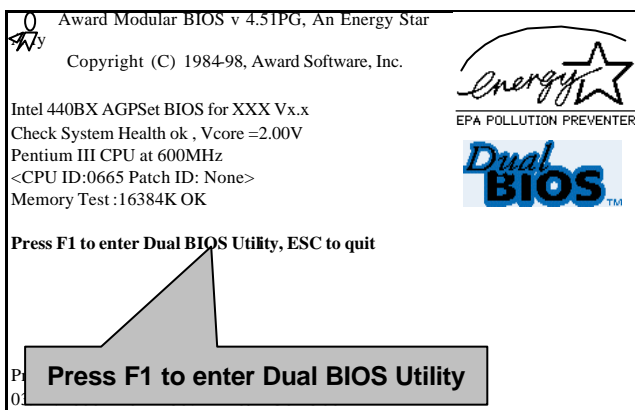

b. Dual BIOS Utility

Dual BIOS Utility V6.60.g.01K (C) 1999, Gigabyte Technology Co., LTD.	
Wide Range Protection	:Disabled
Halt On BIOS Defects	:Disabled
Auto Recovery	:Enabled
Boot From	:Main BIOS
BIOS Recovery	:Main to Backup
F3: Load Default	F5:Start BIOS Recovery
F7: Save And Restart	F9:Exit Without Saving
Use <Space> key to toggle setup	

c. Dual BIOS Item explanation:

Wide Range Protection: Disabled(Default), Enabled*Status 1:*

If any failure (ex. Update ESCD failure, checksum error or reset.) occurs in the Main BIOS , just before the Operating System is loaded and after the power is on, and that the Wide Range Protection is set to "Enable", the PC will boot from Backup BIOS automatically.

Status 2:

If the ROM BIOS on peripherals cards(ex. SCSI Cards, LAN Cards,...) emits signals to request restart of the system after the user make any alteration on it, the boot up BIOS will not be changed to the Backup BIOS.

Halt On BIOS Defects : Disabled(Default), Enabled

If the BIOS occurs a checksum error or the Main BIOS occurs a WIDE RANGE PROTECTION error and Halt On BIOS Defects set to Enable, the PC will show messages on the boot screen, and the system will pause and wait for the user's instruction.

If Auto Recovery : **Disabled**, it will show *<or the other key to continue.>*

If Auto Recovery : **Enabled**, it will show *<or the other key to Auto Recover.>*

Auto Recovery : Enabled(Default), Disabled

When one of the Main BIOS or Backup BIOS occurs checksum failure, the working BIOS will automatically recover the BIOS of checksum failure. (In the Power Management Setup of the BIOS Setting, if ACPI Suspend Type is set to Suspend to RAM, the Auto Recovery will be set to Enable automatically.)

(If you want to enter the BIOS setting, please press "Del" key when the boot screen appears.)

Boot From : Main BIOS(Default), Backup BIOS

Status 1:

The user can set to boot from main BIOS or Backup BIOS.

Status 2:

If one of the main BIOS or the Backup BIOS fails, this item "*Boot From : Main BIOS(Default)*" will become gray and will not be changed by user.

BIOS Recovery : Main to Backup

Auto recovery message:

BIOS Recovery: Main to Backup

The means that the Main BIOS works normally and could automatically recover the Backup BIOS.

BIOS Recovery: Backup to Main

The means that the Backup BIOS works normally and could automatically recover the Main BIOS.

(This auto recovery utility is set by system automatically and can't be changed by user.)



DualBIOS™ Technology FAQ

GIGABYTE Technology is pleased to introduce DualBIOS technology, a hot spare for your system BIOS. This newest "Value-added" feature, in a long series of innovations from GIGABYTE, is available on GA-6BX7+ motherboard. Future GIGABYTE motherboards will also incorporate this innovation.

What' s DualBIOS™?

On GIGABYTE motherboards with DualBIOS there are physically two BIOS chips. For simplicity we' ll call one your "Main BIOS" and the other we' ll call your "Backup" BIOS (your "hot spare"). If your Main BIOS fails, the Backup BIOS almost automatically takes over on your next system boot. Almost automatically and with virtually zero down time! Whether the problem is a failure in flashing your BIOS or a virus or a catastrophic failure o f the Main BIOS chip, the result is the same - the Backup BIOS backs you up, almost automatically.

I. Q: What is DualBIOS™ technology?

Answer:

DualBIOS technology is a patented technology from Giga-Byte Technology. The concept of this technology is based on the redundancy and fault tolerance theory. DualBIOS™ technology simply means there are two system BIOSes (ROM) integrated onto the motherboard. One is a main BIOS, and the other is a backup BIOS. The mainboard will operate normally with the main BIOS, however, if the main BIOS is corrupt or damaged for various reasons, the backup BIOS will be automatically used when the system powered-On. Your PC will operate as before the main BIOS was damaged, and is completely transparent to the user.

II. Q: Why does anyone need a motherboard with DualBIOS™ technology?

Answer:

In today' s systems there are more and more BIOS failures. The most common reasons are virus attacks, BIOS upgrade failures, and/or deterioration of the BIOS (ROM) chip itself.

1. New computer viruses are being found that attack and destroy the system BIOS. They may corrupt your BIOS code, causing your PC to be unstable or even not boot normally.
2. BIOS data will be corrupted if a power loss/surge occurs, or if a user resets the system, or if the power button is pressed during the process of performing a system BIOS upgrade.
3. If a user mistakenly updates their mainboard with the incorrect BIOS file, then the system may not be able to boot correctly. This may cause the PC system hang in operation or during boot.
4. A flash ROM's life cycle is limited according to electronic characteristics. The modern PC utilizes the Plug and Play BIOS, and is updated regularly. If a user changes peripherals often, there is a slight chance of damage to the flash ROM.

With Giga-Byte Technology' s patented DualBIOS™ technology you can reduce the possibility of hangs during system boot up, and/or loss BIOS data due to above reasons. This new technology will eliminate valuable system down time and costly repair bills cause by BIOS failures.

III. Q: How does DualBIOS™ technology work?**Answer:**

1. DualBIOS™ technology provides a wide range of protection during the boot up procedure. It protects your BIOS during system POST, ESCD update, and even all the way to PNP detection/assignment.
2. DualBIOS™ provides automatic recovery for the BIOS. When the first BIOS used during boot up does not complete or if a BIOS checksum error occurs, boot-up is still possible. In the DualBIOS™ utility, the "Auto Recovery" option will guarantee that if either the main BIOS or backup BIOS is corrupted, the DualBIOS™ technology will use the good BIOS and correct the wrong BIOS automatically.
3. DualBIOS™ provides manual recovery for the BIOS. DualBIOS™ technology contains a built-in flash utility, which can flash your system BIOS from backup to main and/or visa versa. There is no need for an OS-dependent flash utility program.
4. DualBIOS™ contains a one-way flash utility. The built-in one-way flash utility will ensure that the corrupt BIOS is not mistaken as the good BIOS during recovery and that the correct BIOS (main vs. backup) will be flashed. This will prevent the good BIOS from being flashed.

IV. Q: Who Needs DualBIOS™ technology?**Answer:**

1. Every user should have DualBIOS™ technology due to the advancement of computer viruses.
Everyday, there are new BIOS-type viruses discovered that will destroy your system BIOS. Most commercial products on the market do not have solutions to guard against this type of virus intrusion. The DualBIOS™ technology will provide a state-of-the-art solution to protect your PC:
Case I.) Vicious computer viruses may wipe out your entire system BIOS. With a conventional single system BIOS PC, the PC will not be functional until it is sent for repairs.
Case II.) If the "Auto Recovery" option is enabled in the DualBIOS™ utility, and if a virus corrupts your system BIOS, the backup BIOS will automatically reboot the system and correct the main BIOS.
Case III.) A user may override booting from the main system BIOS. The DualBIOS™ utility may be entered to manually change the boot sequence to boot from the backup BIOS.

2. During or after a BIOS upgrade, if DualBIOS™ detects that the main BIOS is corrupt, the backup BIOS will take over the boot-up process automatically. Moreover, it will verify the main and backup BIOS checksums when booting-up. DualBIOS™ technology examines the checksum of the main and backup BIOS while the system is powered on to guarantee your BIOS operates properly.
3. Power Users will have the advantage of having two BIOS versions on their mainboard. The benefit is being able to select either version BIOS to suit the performance system needs.
4. Flexibility for high-end desktop PCs and workstation/servers. In the DualBIOS™ utility, the option can be set, "Halt On When BIOS Defects," to be enabled to halt your system with a warning message that the main BIOS has been corrupted. Most workstation/servers require constant operation to guarantee services have not been interrupted. In this situation, the "Halt On When BIOS Defects" message may be disabled to avoid system pauses during normal booting. Another advantage you gain from Giga-Byte's DualBIOS™ technology is the ability to upgrade from dual 2 Mbit BIOS to dual 4 Mbit BIOS in the future if extra BIOS storage is need.

TABLE OF CONTENTS

1. INTRODUCTION

1.1. PREFACE.....1-1
1.2. KEY FEATHERS.....1-1
1.3. PERFORMANCE LIST1-2
1.4. BLOCK DIAGRAM.....1-3
1.5. INTRODUCE THE INTEL Celeron™/PENTIUM® !!! Processor1-4
1.6. WHAT IS AGP?.....1-4

2. SPECIFICATION

2.1. HARDWARE.....2-1
2.2. SOFTWARE.....2-2
2.3. ENVIRONMENT2-2

3. HARDWARE INSTALLATION

3.1. UNPACKING.....3-1
3.2. MAINBOARD LAYOUT3-2
3.3. QUICK REFERENCE FOR JUMPERS & CONNECTORS.....3-2
3.4. DRAM INSTALLATION3-6
3.5. CPU SPEED SETUP3-7
3.6. CMOS RTC & ISA CFG CMOS RAM.....3-8
3.7. SPEAKER CONNECTOR INSTALLATION.....3-9
3.8. HARDWARE RESET SWITCH CONNECTOR INSTALLATION.....3-9
3.9. POWER LED CONNECTOR INSTALLATION3-9
3.10. IDE & ATAPI DEVICE INSTALLATION.....3-9

3.11. PERIPHERAL DEVICE INSTALLATION.....	3-9
3.12. KEYBOARD & PS/2 MOUSE INSTALLATION.....	3-9
4. BIOS CONFIGURATION	
4.1. ENTERING SETUP.....	4-1
4.2. CONTROL KEYS.....	4-1
4.3. GETTING HELP.....	4-2
4.3.1. Main Menu	4-2
4.3.2. Status Page Setup Menu / Option Page Setup Menu.....	4-2
4.4. THE MAIN MENU.....	4-2
4.5. STANDARD CMOS SETUP MENU.....	4-4
4.6. BIOS FEATURES SETUP	4-8
4.7. CHIPSET FEATURES SETUP	4-13
4.8. POWER MANAGEMENT SETUP	4-17
4.9. PNP/PCI CONFIGURATION	4-22
4.10. LOAD BIOS DEFAULTS.....	4-24
4.11. LOAD PERFORMANCE DEFAULTS.....	4-25
4.12. INTEGRATED PERIPHERALS.....	4-26
4.13. SPUERVISOR PASSOWORD/USER PASSWORD.....	4-31
4.14. IDE HDD AUTO DETECTION	4-32
4.15. SAVE & EXIT SETUP.....	4-33
4.16. EXIT WITHOUT SAVING.....	4-34
Appendix A: Ultra66 Driver Install Produce.....	A-1

1. INTRODUCTION

1.1. PREFACE

Welcome to use the **6BX7+** motherboard. It is a Pentium® II / !!! / Celeron Processor based PC / AT compatible system with AGP / PCI / ISA Bus, and has been designed to be the fastest PC / AT system. There are some new features allow you to operate the system with just the performance you want.

This manual also explains how to install the motherboard for operation, and how to set up your CMOS CONFIGURATION with BIOS SETUP program.

1.2. KEY FEATURES

- ❑ Intel Celeron™ / Pentium® !!! Socket 370 Processor based PC / AT compatible main board.
- ❑ Socket 370 Pins ZIF white socket on board.
- ❑ Intel 440BX chipset, Supports AGP / SDRAM / Ultra DMA/33 IDE / Keyboard and PS/2 Mouse Power On / ACPI features.
- ❑ Supports 4xDIMMs using 3.3V SDRAM DIMM module.
- ❑ Supports Intel LDCM® Network Manageability.
- ❑ Supports 8 MB – 1GB SDRAM memory on board.
- ❑ Supports ECC or Non-ECC type DRAM module.
- ❑ 1xAGP slot, 6xPCI Bus slots, 1xISA Bus slots.
- ❑ Supports 2 channels Ultra DMA/33 IDE ports for 4 IDE Devices.
- ❑ Promise Chipset supports 2 channels Ultra DMA66/33 IDE Port for 4 IDE Device.
- ❑ Supports 2xCOM (16550), 1xLPT (EPP / ECP), 1x Floppy port.
- ❑ Supports 4xUSB ports (Front Panel USBx2, Back Panel USBx2), 1xPS/2 Mouse & 1xPS/2 Keyboard.
- ❑ Licensed AWARD BIOS, 2M bits FLASH ROM.
- ❑ Support **Dual BIOS** and **BIOS Write Protection**.
- ❑ Support **Suspend To RAM** Function.
- ❑ Support **CPU Over Voltage Select (Magic Booster)**.
- ❑ Support **CPU Over Voltage Protection**.
- ❑ 30.5 cm x 19.5 cm ATX SIZE form factor, 4 layers PCB.

1.3. PERFORMANCE LIST

The following performance data list is the testing results of some popular benchmark testing programs.

These data are just referred by users, and there is no responsibility for different testing data values gotten by users. (Different Hardware & Software configuration will result in different benchmark testing results.)

- CPU Intel Socket 370 Pentium® !!! 800EB MHz processor
- DRAM (256x1) MB MOSEL 9923PR V54C328804VCT75)
- CACHE SIZE 256 KB included in CPU
- DISPLAY GA-660Plus AGP Card
- STORAGE Onboard Promise IDE (Quantum KA13600AT)
- O.S. Windows NT™4.0 SPK6a
- DRIVER Display Driver at 1024 x 768 x 65536 colors x 75Hz.
Promise Ultra Driver (ver.1.44 Build:0728)

Processor	Intel Pentium® !!! Socket 370 800EB MHz (100 x 8.0)
Winbench99	
CPU mark99	72
FPU Winmark99	4250
Business Disk Winmark99	5820
Hi-End Disk Winmark99	14000
Business Graphics Winmark99	393
Hi-End Graphics Winmark99	738
Winstone99	
Business Winstone99	44.2
Hi-End Winstone99	47.9

1.4. BLOCK DIAGRAM

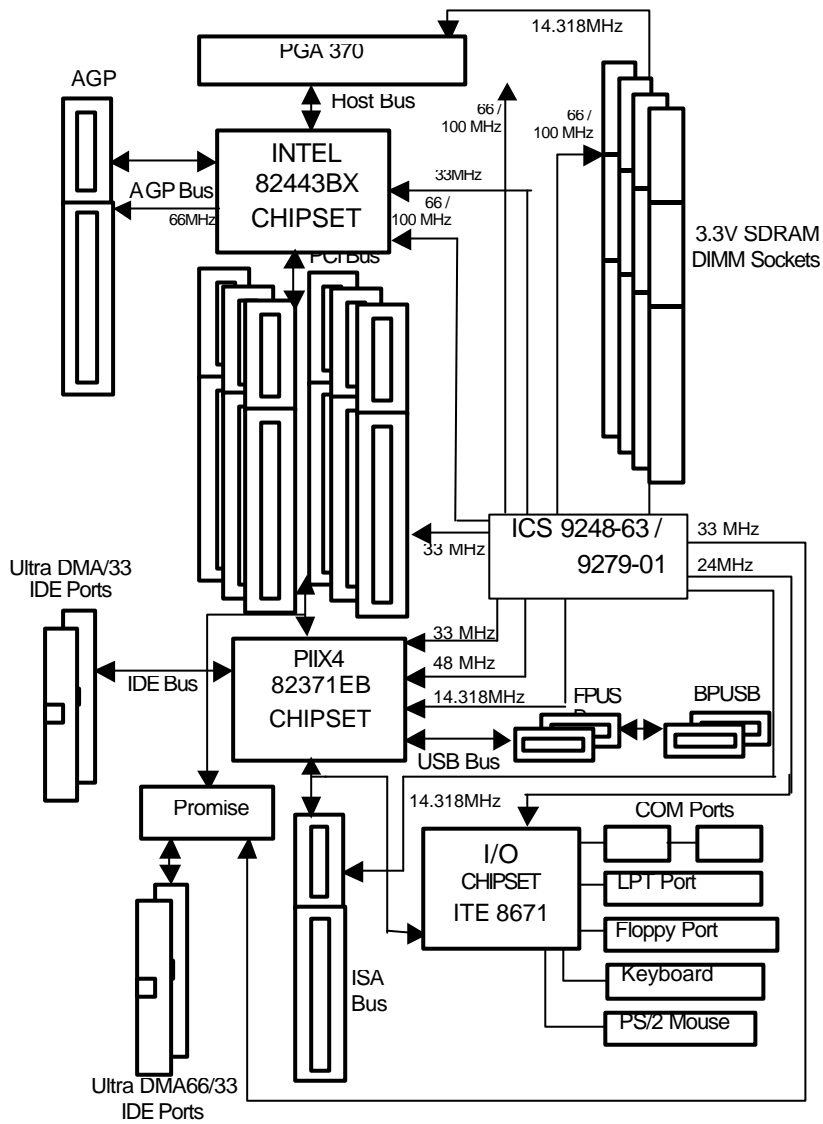

1.5. INTRODUCE THE INTEL® Celeron™ /Pentium® !!! Socket 370 Processor



Figure 1.1: INTEL® Celeron™ /Pentium® !!! Socket370 Processor

1.6 What is AGP?

The Accelerated Graphics Port (AGP) is a new port on the Host-To-PCI bridge device that supports an AGP port. The main purpose of the AGP port is to provide fast access to system memory.

The AGP port can be used either as fast PCI port (32-bits at 66MHz vs.32-Bits at 33MHz) or as an AGP port which supports 2x data-rate, a read queue, and side band addressing. When the 2x-data rate is used the port can transmit data at 533MB/sec ($66.6 \times 2 \times 4$). The read-queue can be used to pipeline reads – removing the effects of the reads-latency. Side band addressing can be used to transmit the data address on a separate line in order to speed up the transaction.

2. SPECIFICATION

2.1. HARDWARE

- CPU
 - Celeron™/Pentium® !!! Socket 370 Processor 300– 800 MHz.
 - 66/100 MHz Socket 370 on board.
- PROTECTION
 - Supports **CPU Over Voltage Select (Magic Booster)**.
 - Speaker Alarm when detect "CPU FAN Failure" or "CPU Overheat" .
 - Automatically slow down CPU speed when "CPU Overheat".
 - Intel LDCM® supported.
 - H/W monitor power status ($\pm 5V$, $\pm 12V$, VGTL, 5VSB, CPU voltage & CMOS battery voltage).(Optional)
- SPEED
 - 66/100 MHz system speed.
 - 66 MHz AGP bus speed. (2X mode 133MHz)
 - 33 MHz PCI-Bus speed.
 - 8 MHz AT bus speed.
- DRAM MEMORY
 - 4 banks 168 pins DIMM module sockets on board.
 - Use 8 / 16 / 32 / 64 / 128 / 256 MB DIMM module DRAM.
 - 8 ~ 1GB SDRAM.
 - Supports 3.3V SDRAM.
 - Supports ECC or Non-ECC type DRAM.
 - Supports **Suspend To RAM** Function.
- CACHE MEMORY
 - 32 KB L1 cache memory included in CPU.
 - L2 cache memory included in CPU (depends on CPU type)
 - Supports DIB speed mode for L2 Cache.
- I/O BUS SLOTS
 - 6 33MHz Master / Slave PCI-BUS.
 - 1 8MHz 16 bits ISA BUS.
 - 1 66MHz / 133MHz AGP bus.
- IDE PORTS
 - 2 Ultra DMA/33 Bus Master IDE channels onboard. (Using IRQ14,15)

- Support Mode 3,4 IDE & ATAPI CD– ROM.
- Promise Chipset supports 2 Channels Ultra DMA66/33 IDE Port for 4 IDE device.
- I/O PORTS
 - Supports 2 16550 COM ports.
 - Supports 1 SPP/EPP/ECP LPT port.
 - Supports 1 Floppy port.
 - Supports 4 USB ports.
 - Supports PS/2 Mouse & PS/2 Keyboard.
- GREEN FUNCTION
 - Suspend mode support.
 - Green switch & ACPI LED support.
 - IDE & Display power down support.
 - Monitor all IRQ / DMA / Display / I/O events.
- BIOS
 - 2M bits FLASH ROM.
 - Support **Dual BIOS** and **BIOS Write Protection**.
 - Supports Plug & Play, DMI , ACPI Function.
- DIMENSION
 - ATX Form Factor, 4 layers PCB.

2.2. SOFTWARE

- DRIVER
 - IUCD.
- BIOS
 - Licensed AWARD BIOS.
 - AT CMOS Setup, BIOS / Chipset Setup, Green Setup, Hard Disk Utility included.
- O.S.
 - Operation with MS-DOS®, Windows®95, Windows®98, WINDOWS NT™, OS/2, NOVELL and SCO UNIX.

2.3. ENVIRONMENT

- Ambient Temp.
 - 0°C to +50°C (Operating).
- Relative Hum.
 - 0 to +85% (Operating).
- Altitude
 - 0 to 10,000 feet (Operating).
- Vibration
 - 0 to 1,000 Hz.
- Electricity
 - 4.9 V to 5.2 V. (Max. 20A current at 5V.)

3. HARDWARE INSTALLATION

3.1. UNPACKING

The main board package should contain the following:

- The **6BX7+** main board.
- USER' S MANUAL for main board.
- Cable set for DMA66/33 device, Floppy device.
- CD for main board Utility.

The main board contains sensitive electric components, which can be easily damaged by static electricity, so the main board should be left in its original packing until it is installed.

Unpacking and installation should be done on a grounded anti-static mat. The operator should be wearing an anti static wristband, grounded at the same point as the anti -static mat.

Inspect the main board carton for obvious damage. Shipping and handling may cause damage to your board. Be sure there are no shipping and handling damages on the board before proceeding.

After opening the main board carton, extract the system board and place it only on a grounded anti-static surface component side up. Again inspect the board for damage. Press down on all of the socket IC's to make sure that they are properly seated. Do this only on with the board placed on a firm flat surface.

⚠ **DO NOT APPLY POWER TO THE BOARD IF IT HAS BEEN DAMAGED.**

3.2. MAINBOARD LAYOUT

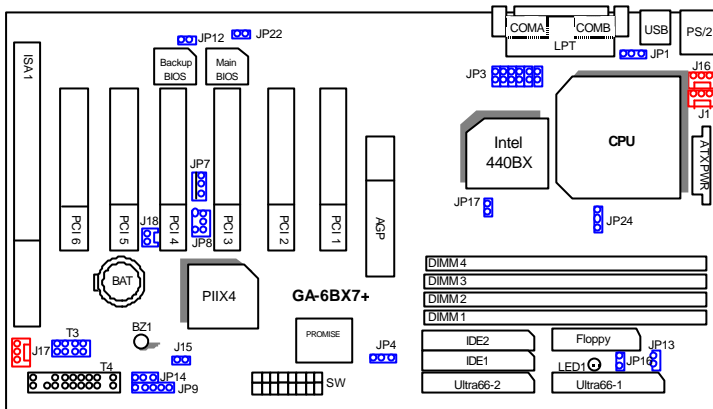

<Figure 3.1>

3.3. QUICK REFERENCE FOR JUMPERS & CONNECTORS

◆ I/O Ports Connector	
USB	USB port.
PS/2	For PS/2 Keyboard / Mouse port.
IDE 1	For Primary IDE port.
IDE 2	For Secondary IDE port.
Ultra66-1	For Ultra DMA66 Primary IDE port.
Ultra66-2	For Ultra DMA66 Secondary IDE port.
Floppy	For Floppy port
COM B	For Serial port2 (COM B).[Support External Modem Ring On]
COM A	For Serial port1 (COM A).[Support External Modem Ring On]
LPT	For LPT port.
ATX POWER	For ATX Power Connector.

◆ Socket 370	
For Celeron™ /Pentium® !!!Socket 370 Processor installed	

◆ JP12 : Case Open	
Pin No.	Function
1	Signal
2	GND

◆ J1: CPU FAN Connector	
Pin No.	Function
1	GND.
2	+12V
3	SENSE

◆ J16 : POWER FAN Connector	
Pin No.	Function
1	GND.
2	+12V
3	SENSE

◆ J17 : PANEL(SYSTEM) FAN Connector	
Pin No.	Function
1	GND.
2	+12V
3	SENSE

◆ J15 : System After Ac Back	
Pin No.	Function
Open	Soft Off (Default)
Close	Full On

◆ JP1 : PS/2 Keyboard Power On Selection	
Pin No.	Function
1-2 close	PS/2 Enabled Keyboard power on.
2-3 close	PS/2 Disabled Keyboard power on.(Default)

◆ JP7 : Wake on LAN	
Pin No.	Function
1	+5V SB
2	GND
3	Signal

◆ JP9 IR: INFRARED Connector (Optional)	
Pin No.	Function
1	IR DATA OUTPUT
2	GND
3	IR DATA INPUT
4	NC
5	VCC (+5V)

◆ JP8 SB-LINK : For PCI Sound Card Connector (Optional)	
Pin No.	Function
1	Signal
2	GND
3	NC
4	Signal
5	GND
6	Signal

◆ JP14 : CLEAR CMOS	
Pin No.	Function
1-2 close	Clear CMOS
2-3 close	Normal (Default)

◆ JP13 / JP17 : Close STR Enable	
Pin No.	Function
1	Signal
2	GND

◆ J18 Ring POW On : Internal Modem Ring Power On.	
Pin No.	Function
1	Signal
2	GND

◆ JP3 : CPU Over Voltage Select (Magic Booster)	
Pin No.	Function
1-2 close	Normal
3-4 close	CPU Voltage is rising 10%
5-6 close	CPU Voltage is rising 20%
7-8 close	CPU Voltage is rising 30%
9-10 close	CPU Voltage is rising 40%
11-12 close	CPU Voltage is rising 50%

◆ JP4 : ATA66 Disable / Enable	
Pin No.	Function
1-2 close	Disabled
2-3 close	Enabled (Default)

◆ JP22 : BIOS Flash ROM Write Protection	
Pin No.	Function
open	Normal (Default)
close	Write Protection

◆ T3 : FPUSB	
Pin No.	Function
1	VCC
2	USB D0-
3	USB D0+
4	GND
5	VCC
6	USB D1-
7	USB D1+
8	GND

◆ JP24 : System Acceleration	
Pin No.	Function
1-2 close	For 100MHz Turbo and other frequencies
2-3 close	For 100MHz Normal (Default)

T4 : 2*11PIN Jumper

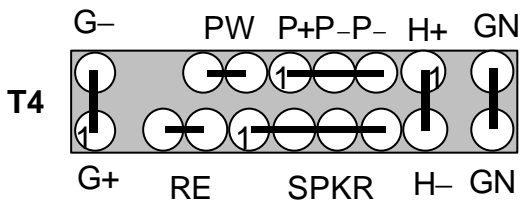

PW : Soft Power Connector



Open: Normal Operation
Short: Power On/Off

RE : Reset Switch



Open: Normal Operation
Short: For Hardware Reset System

P+P- P- : Power LED



PIN 1 : LED anode (+)
 PIN 2 : LED cathode (-)
 PIN 3 : LED cathode (-)

SPKR : External Speaker Connector



PIN 1 : VCC (+)
 PIN 2 : VCC
 PIN 3 : Data
 PIN 4 : Data (-)

H+H- : IDE Hard Disk Active LED



PIN 1: LED anode (+)
 PIN 2: LED cathode (-)

GN: Green Function Switch



Open : Normal operation
 Short : Entering Green Mode

G- G+: Green LED



PIN 1 : LED anode (+)
 PIN 2 : LED cathode (-)

3.4. DRAM INSTALLATION

The main board can be installed with 8 / 16 / 32 / 64 / 128 / 256 MB 168 pins DIMM module DRAM, and the DRAM speed must be 67~100 MHz for SDRAM when system bus speed is set to 66MHz. When system bus speed is set to 100MHz, 100MHz SDRAM is required. The DRAM memory system on main board consists of bank 0, 1, 2 & bank 3.

Since 168 pins DIMM module is 64 bits width, therefore 1 piece of DIMM module may match a 64 bits system. The total memory size is 8 MB ~1GB SDRAM. The DRAM installation position refer to Figure 3.1, and notice the Pin 1 of DIMM module must match with the Pin 1 of DIMM socket. Insert the

DRAM DIMM module into the DIMM socket at Vertical angle. If there is a wrong direction of Pin 1, the DRAM DIMM module could not be inserted into socket completely.

3.5. CPU SPEED SETUP

The system bus speed can be set to 66 / 100MHz form the DIP SWITCH (**SW**). The user can change the DIP SWITCH selection to set up the CPU speed for different processors.

Pentium® II / III CPU	1	2	3	4	5	6	7	8
300 / 66MHz	OFF	ON	OFF	ON	ON	OFF	OFF	ON
333 / 66MHz	ON	OFF	OFF	ON	ON	OFF	OFF	ON
366 / 66MHz	OFF	OFF	OFF	ON	ON	OFF	OFF	ON
400 / 66MHz	ON	ON	ON	OFF	ON	OFF	OFF	ON
433 / 66MHz	OFF	ON	ON	OFF	ON	OFF	OFF	ON
466 / 66MHz	ON	OFF	ON	OFF	ON	OFF	OFF	ON
500 / 66MHz	OFF	OFF	ON	OFF	ON	OFF	OFF	ON
533 / 66MHz	ON	ON	OFF	OFF	ON	OFF	OFF	ON
* 566 / 66MHz	OFF	ON	OFF	OFF	ON	OFF	OFF	ON
500 / 100MHz	ON	OFF	OFF	ON	OFF	OFF	OFF	OFF
550 / 100MHz	OFF	OFF	OFF	ON	OFF	OFF	OFF	OFF
600 / 100MHz	ON	ON	ON	OFF	OFF	OFF	OFF	OFF
650 / 100MHz	OFF	ON	ON	OFF	OFF	OFF	OFF	OFF
700 / 100MHz	ON	OFF	ON	OFF	OFF	OFF	OFF	OFF
750 / 100MHz	OFF	OFF	ON	OFF	OFF	OFF	OFF	OFF
800 / 100MHz	ON	ON	OFF	OFF	OFF	OFF	OFF	OFF
* 850 / 100MHz	OFF	ON	OFF	OFF	OFF	OFF	OFF	OFF

★ We don't recommend you to setup your CPU ratio above 8 nth, it doesn't support now.

Main Clock Table				
CLK	5	6	7	8
66 MHz	ON	OFF	OFF	ON
152 MHz	ON	OFF	ON	OFF
142MHz	ON	ON	OFF	OFF
100 MHz	OFF	OFF	OFF	OFF
112MHz	OFF	OFF	ON	OFF
124 MHz	OFF	ON	ON	OFF
133 MHz	OFF	ON	OFF	OFF
PCI Run 44.3 MHz				
133 MHz	ON	ON	ON	OFF
PCI Run 33.3 MHz				

- The CPU is a sensitive electric component and it can be easily damaged by static electricity, so users must keep it away from metal surface when the CPU is installed onto main board.

3.6. CMOS RTC & ISA CFG CMOS RAM

There're RTC & CMOS RAM on board; they have a power supply from external battery to keep the DATA inviolate & effective. The RTC is a REAL-TIME CLOCK device, which provides the DATE & TIME to system. The CMOS RAM is used for keeping the information of system configuration, so the system can automatically boot OS every time. Since the lifetime of internal battery is 5 years, the user can change a new Battery to replace old one after it cannot work.

- Danger of explosion if battery is incorrectly replaced.
- Replace only with the same or equivalent type recommended by the manufacturer.
- Dispose of used batteries according to the manufacturer' s instructions.

3.7. SPEAKER CONNECTOR INSTALLATION

There is a speaker in AT system for sound purpose. The 4 - Pins connector **SPKR** is used to connect speaker. Anode connects +, Cathode connects -.

3.8. HARDWARE RESET SWITCH CONNECTOR INSTALLATION

The RESET switch on panel provides users with HARDWARE RESET function. The system will do a cold start after the RESET switch is pushed and released by user. The RESET switch is a 2 PIN connector and should be installed to **RST** on main board.

3.9. POWER LED CONNECTOR INSTALLATION

System has Power LED lamp on the panel of case. The Power LED will light on off or flash to indicate which step on the system. The connector should be connected to **PWR** of main board in correct direction.

3.10. IDE & ATAPI DEVICE INSTALLATION

There are two-Enhanced PCI IDE ports (**IDE1, IDE2**) on board, which following ATAPI standard SPEC. Any one IDE port can connected to two ATAPI devices (IDE Hard Disk, CD-ROM & Tape Driver), so total four ATAPI devices can exist in a system. The **HD** is the active LED port for ATAPI devices.

3.11. PERIPHERAL DEVICE INSTALLATION

After the I/O device installation and jumpers setup, the main board can be mounted into the case and fixed by screw. To complete the main board installation, the peripheral device could be installed now. The basic system needs a display interface card. If the PCI - Bus device is to be installed in the system, any one of four PCI - Bus slots can be used.

3.12. KEYBOARD & PS/2 MOUSE INSTALLATION

The main board supports PS/2 Mouse. The BIOS will auto detect whether the PS/2 Mouse is installed or not & assign IRQ12 for PS/2 Mouse port if it is installed. After installing the peripheral device, the user should check everything again, and prepare to power-on the system.