

586SGM

USER'S MANUAL

- * Supports MMX CPU.
- * Switching mode Voltage regulator on Board.
- * Modem-Ring-On on COM2.
- * Supports Cyrix / IBM 6x86MX & AMD-K6 CPU.
- * Supports 3 steps ACPI LED.

Pentium[®] Processor PCI - ISA BUS MAINBOARD

REV. 1.0 First Edition

Release Date 98.01.06

R-10-01-080106

The author assumes no responsibility for any errors or omissions which may appear in this document nor does it make a commitment to update the information contained herein.

* THIRD-PARTY BRANDS AND NAMES ARE THE PROPERTY OF THEIR RESPECTIVE OWNERS.

JANUARY 6, 1998 Taipei, Taiwan

I. Quick Installation Guide:

CPU	JP2	JP3	JP4	JP5	JP6	JP7	JP8	JP9	JP1 3	JP1 4	JP1 9	JP2 0
1. Pentium [®] Processor 90 MHz	OFF	OFF	OFF	2-3	ON	ON	ON	ON	1-2	1-2	ON	2-3
2. Pentium [®] Processor 100 MHz	OFF	OFF	OFF	2-3	ON	ON	ON	ON	1-2	1-2	OFF	2-3
3. Pentium [®] Processor 120 MHz	OFF	OFF	ON	2-3	ON	ON	ON	ON	1-2	1-2	ON	2-3
4. Pentium [®] Processor 133 MHz	OFF	OFF	ON	2-3	ON	ON	ON	ON	1-2	1-2	OFF	2-3
5. Pentium [®] Processor 150 MHz	OFF	ON	ON	2-3	ON	ON	ON	ON	1-2	1-2	ON	2-3
6. Pentium [®] Processor 166 MHz	OFF	ON	ON	2-3	ON	ON	ON	ON	1-2	1-2	OFF	2-3
7. Pentium [®] Processor 180 MHz	OFF	ON	OFF	2-3	ON	ON	ON	ON	1-2	1-2	ON	2-3
8. Pentium [®] Processor 200 MHz	OFF	ON	OFF	2-3	ON	ON	ON	ON	1-2	1-2	OFF	2-3
9. Intel MMX-150MHz	OFF	ON	ON	1-2	OFF	OFF	OFF	ON	1-2	1-2	ON	2-3
10. Intel MMX-166MHz	OFF	ON	ON	1-2	OFF	OFF	OFF	ON	1-2	1-2	OFF	2-3
11. Intel MMX-200MHz	OFF	ON	OFF	1-2	OFF	OFF	OFF	ON	1-2	1-2	OFF	2-3
12. Intel MMX-233MHz	OFF	OFF	OFF	1-2	OFF	OFF	OFF	ON	1-2	1-2	OFF	2-3
13. P54CT-150 MHz	OFF	ON	ON	1-2	OFF	OFF	OFF	ON	1-2	1-2	ON	2-3
14. P54CT-166 MHz	OFF	ON	ON	1-2	OFF	OFF	OFF	ON	1-2	1-2	OFF	2-3

15.P54CTB-150 MHz	OFF	ON	ON	1-2	OFF	OFF	OFF	ON	1-2	1-2	ON	2-3
16.P54CTB-166 MHz	OFF	ON	ON	1-2	OFF	OFF	OFF	ON	1-2	1-2	OFF	2-3
17.P54CTB-180 MHz	OFF	ON	OFF	1-2	OFF	OFF	OFF	ON	1-2	1-2	ON	2-3
18.P54CTB-200 MHz	OFF	ON	OFF	1-2	OFF	OFF	OFF	ON	1-2	1-2	OFF	2-3
19.AMDK5-PR133	OFF	OFF	ON	2-3	ON	ON	ON	ON	1-2	1-2	OFF	2-3
20.AMDK5-PR166	OFF	ON	ON	2-3	ON	ON	ON	ON	1-2	1-2	OFF	2-3
CPU		JP3	JP4	JP5	JP6	JP7	JP8	JP9	JP1 3	JP1 4	JP1 9	JP2 0
21. AMD-K6/166 (2.9V)	OFF	ON	ON	1-2	ON	OFF	OFF	ON	1-2	1-2	OFF	2-3
22. AMD-K6/180 (2.9V)	OFF	ON	OFF	1-2	ON	OFF	OFF	ON	1-2	1-2	ON	2-3
23. .AMD-K6/200 (2.9V)	OFF	ON	OFF	1-2	ON	OFF	OFF	ON	1-2	1-2	OFF	2-3
24. AMD-K6/233 (3.2V)	OFF	OFF	OFF	1-2	OFF	OFF	ON	ON	1-2	1-2	OFF	2-3
25. Cyrix / IBM 6x86-120 MHz- PR150+	OFF	OFF	ON	2-3	ON	ON	ON	ON	1-2	1-2	ON	2-3
26. Cyrix / IBM 6x86-133 MHz- PR166+	OFF	OFF	ON	2-3	ON	ON	ON	ON	1-2	1-2	OFF	2-3
27. Cyrix / IBM 6x86-150 MHz- PR200+	OFF	ON	ON	2-3	ON	ON	ON	ON	1-2	1-2	ON	2-3
28. Cyrix / IBM 6x86L- PR150+ (2.8V)	OFF	OFF	ON	1-2	OFF	OFF	OFF	ON	1-2	1-2	ON	2-3
29. Cyrix / IBM 6x86L-PR166+ (2.8V)	OFF	OFF	ON	1-2	OFF	OFF	OFF	ON	1-2	1-2	OFF	2-3
30. Cyrix/ IBM 6x86L-PR200+ (2.8V) *	OFF	OFF	ON	1-2	OFF	OFF	OFF	ON	1-2	2-3	OFF	1-2

31. Cyrix/IBM 6x86MX-PR150 (60*2 2.9V)	OFF	OFF	ON	1-2	ON	OFF	OFF	ON	1-2	1-2	ON	2-3
32. Cyrix/IBM 6x86MX-PR166 (60*2.5 2.9V)	OFF	ON	ON	1-2	ON	OFF	OFF	ON	1-2	1-2	ON	2-3
33. Cyrix/IBM 6x86MX-PR166 (66*2 2.9V) *	OFF	OFF	ON	1-2	ON	OFF	OFF	ON	1-2	1-2	OFF	2-3
34. Cyrix/IBM 6x86MX-PR200 (60*3 2.9V)	OFF	ON	OFF	1-2	ON	OFF	OFF	ON	1-2	1-2	ON	2-3
35. Cyrix/IBM 6x86MX-PR200 (66*2.5 2.9V)	OFF	ON	ON	1-2	ON	OFF	OFF	ON	1-2	1-2	OFF	2-3

CPU	JP2	JP3	JP4	JP5	JP6	JP7	JP8	JP9	JP1	JP1	JP1	JP2
									3	4	9	0
36. Cyrix/IBM 6x86MX-PR200 (75*2 2.9V)*	OFF	OFF	ON	1-2	ON	OFF	OFF	ON	1-2	2-3	OFF	1-2
37. Cyrix/IBM 6x86MX-PR233 (66*3 2.9V)	OFF	ON	OFF	1-2	ON	OFF	OFF	ON	1-2	1-2	OFF	2-3
38. Cyrix/IBM 6x86MX-PR233 (75*2.5 2.9V)*	OFF	ON	ON	1-2	ON	OFF	OFF	ON	1-2	2-3	OFF	1-2
39. Cyrix/IBM 6x86MX-PR233 (83*2 2.9V)*	OFF	OFF	ON	1-2	ON	OFF	OFF	ON	2-3	1-2	ON	1-2
40. Cyrix/IBM 6x86MX-PR266 (66*3.5 2.9V)*	OFF	OFF	OFF	1-2	ON	OFF	OFF	ON	1-2	1-2	OFF	2-3
41. Cyrix/IBM 6x86MX-PR266 (75*3 2.9V)*	OFF	ON	OFF	1-2	ON	OFF	OFF	ON	1-2	2-3	OFF	1-2
42. Cyrix/IBM 6x86MX-PR266 (83*2.5 2.9V)*	OFF	ON	ON	1-2	ON	OFF	OFF	ON	2-3	1-2	ON	1-2

* Note : If Cyrix 6x86 is being used, please check the CPU Date Code after 605.

* J4 1-2 Close Sound Disabled, 2-3 Close Sound Enabled.

* Note : We don't recommend you to setup up your system speed up to 75 or 83 MHz because they are not the standard spec. of peripherals. If you want to run 75 or 83 MHz in your system properly, it depends on your hardware configurations : CPU, SDRAM, Cards, etc.

1. Pentium[®] Processor 90 MHz

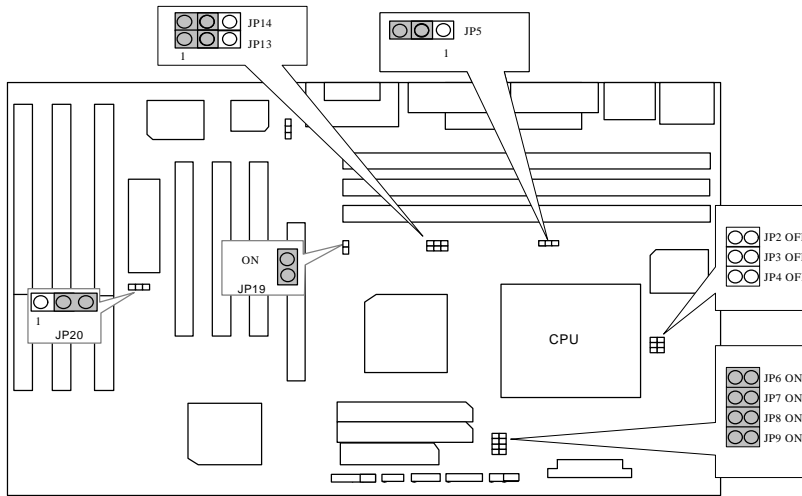

2. Pentium[®] Processor 100 MHz

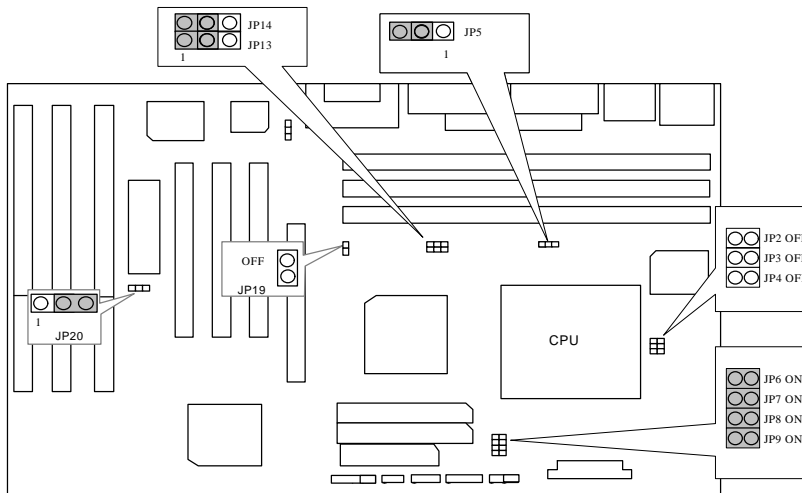

3. Pentium[®] Processor 120 MHz

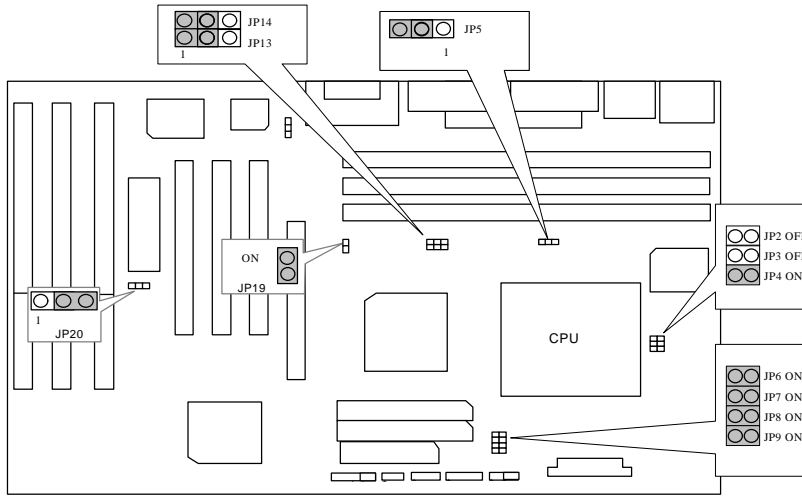

4. Pentium[®] Processor 133 MHz

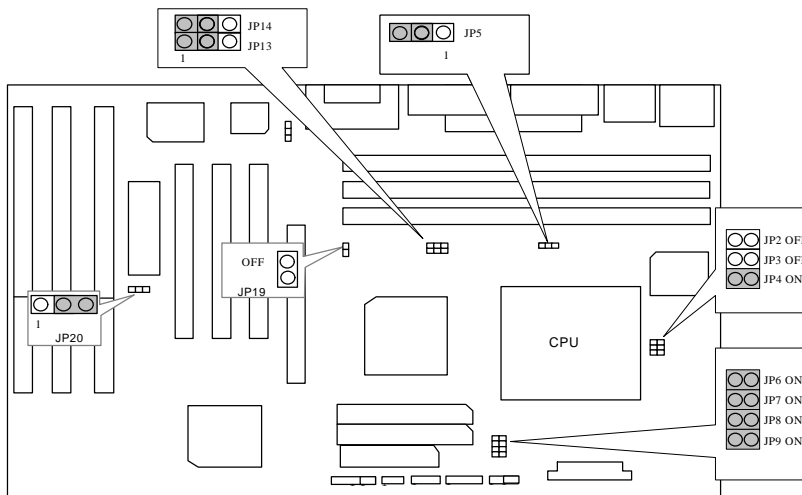

5. Pentium[®] Processor 150 MHz

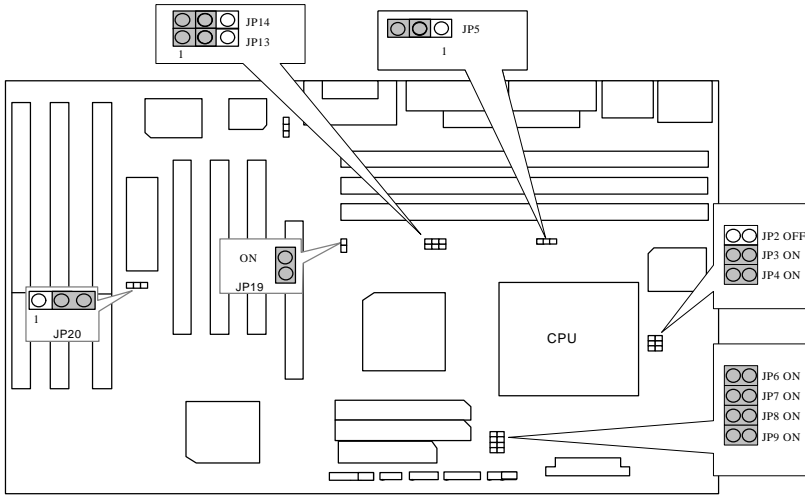

6. Pentium[®] Processor 166 MHz

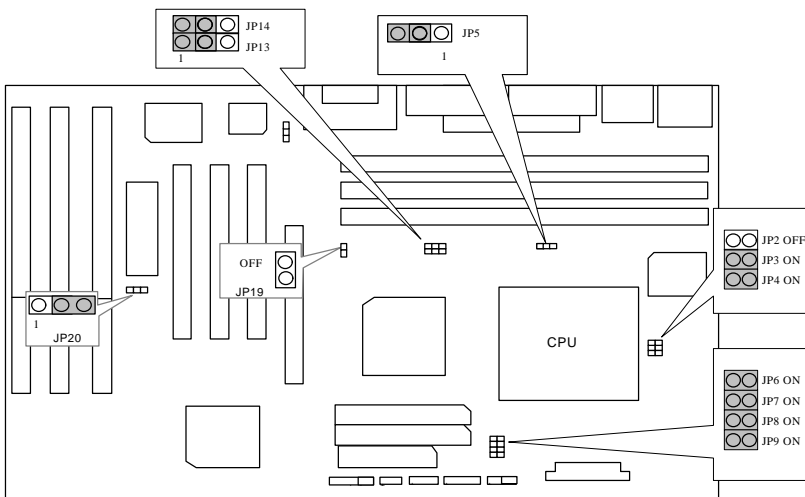

7. Pentium[®] Processor 180 MHz

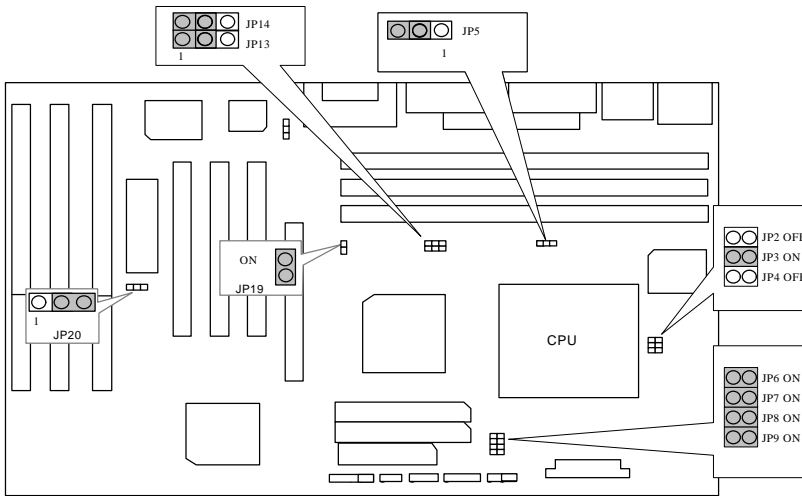

8. Pentium[®] Processor 200 MHz

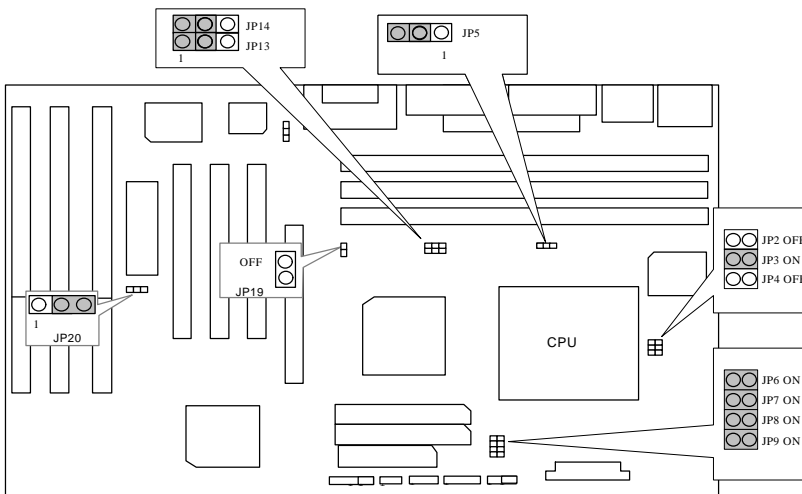

9. Intel MMX-150 MHz

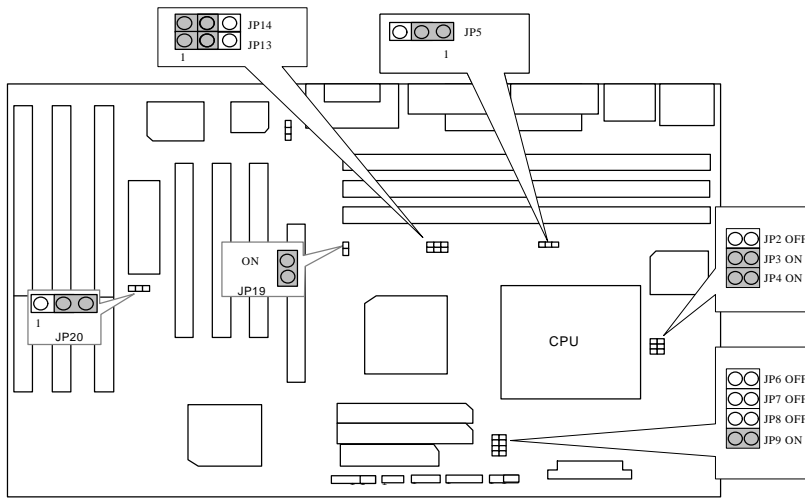

10. Intel MMX-166 MHz

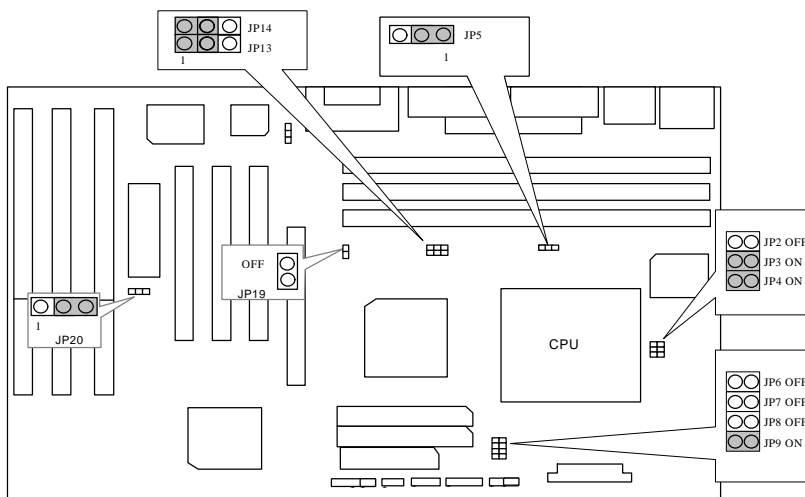

11. Intel MMX-200 MHz

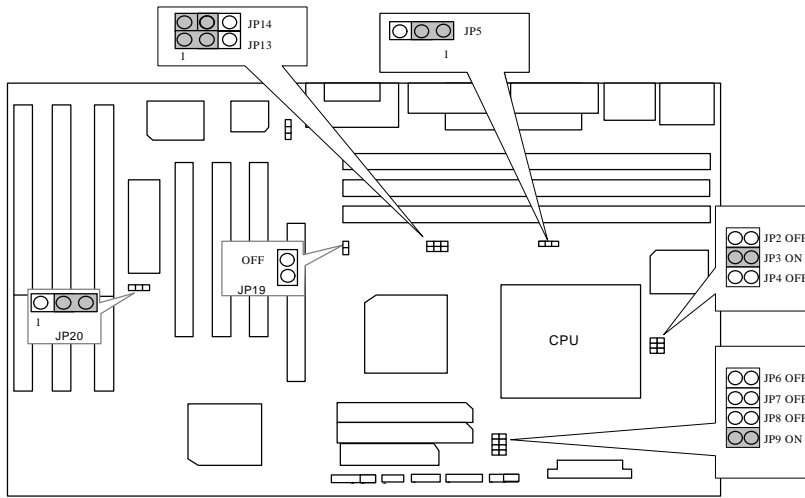

12. Intel MMX-233 MHz

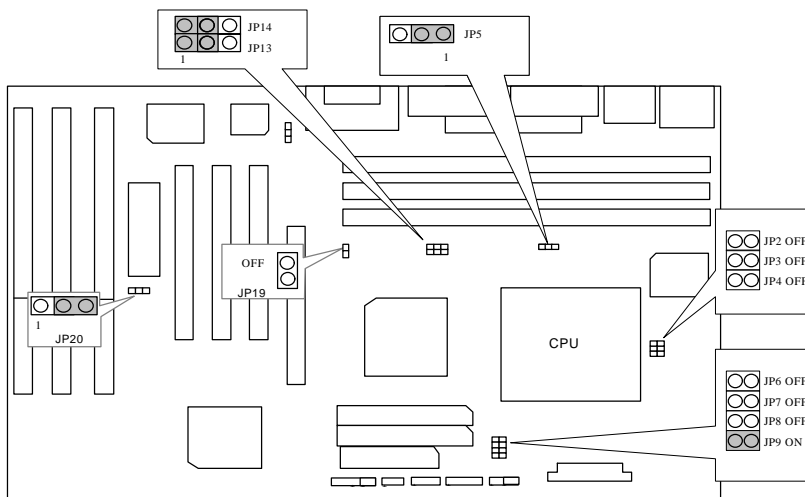

13. P54CT-150 MHz

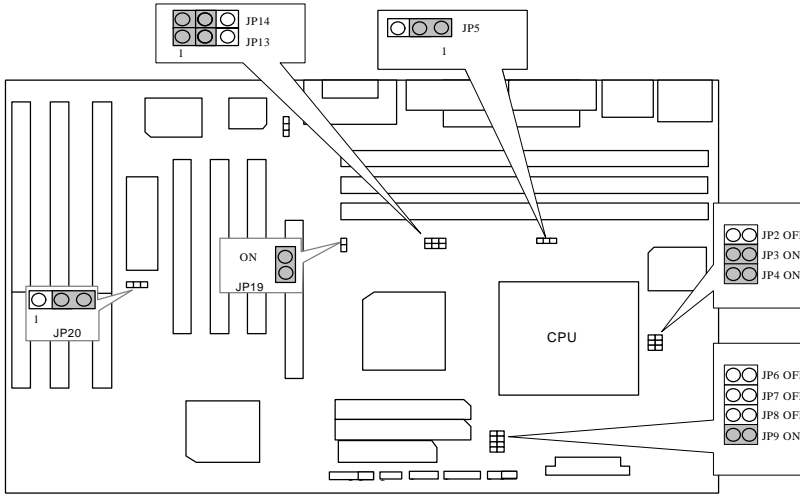

14. P54CT-166 MHz

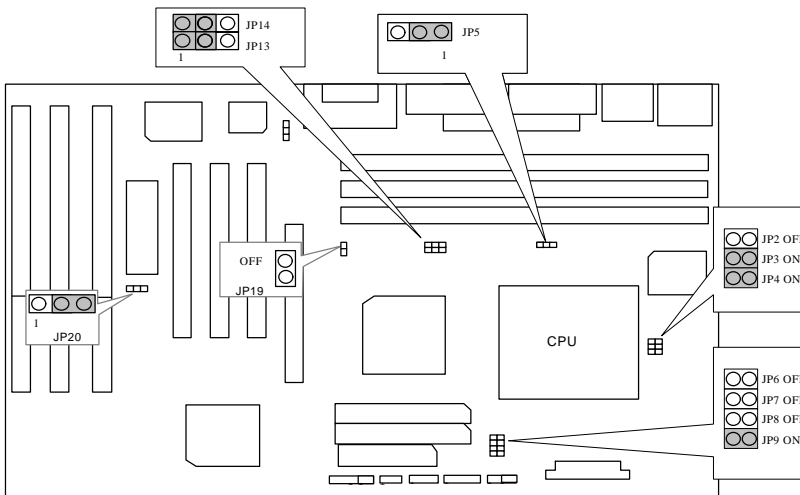

15. P54CTB-150 MHz

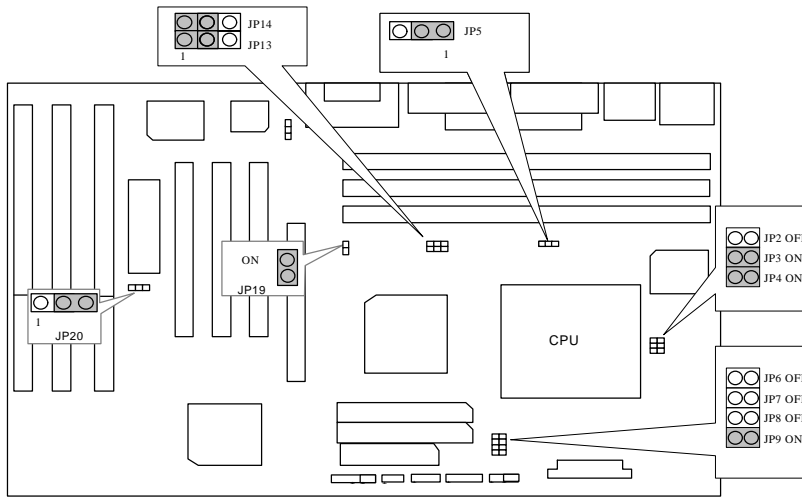

16. P54CTB-166 MHz

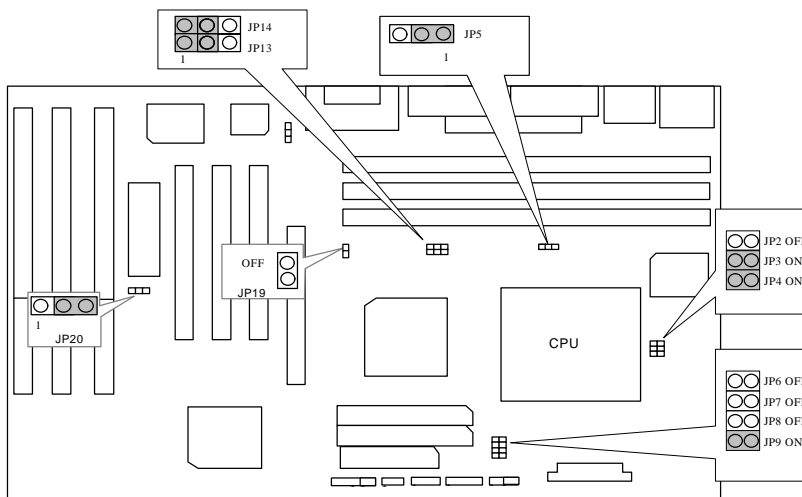

17. P54CTB-180 MHz

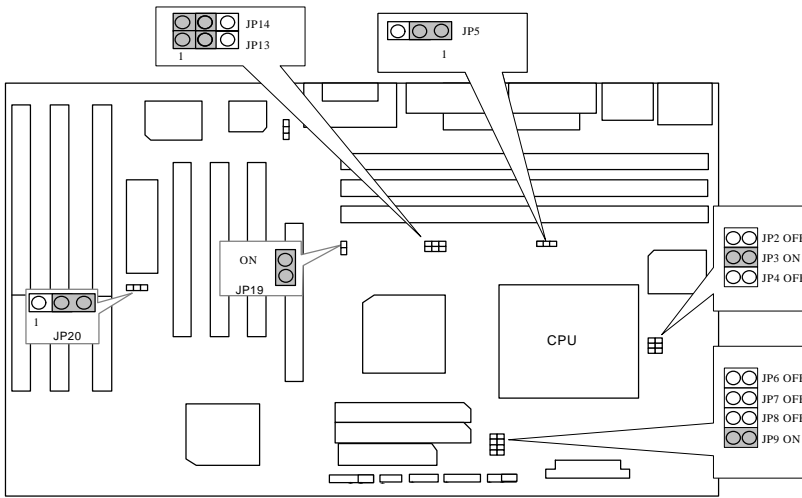

18. P54CTB-200 MHz

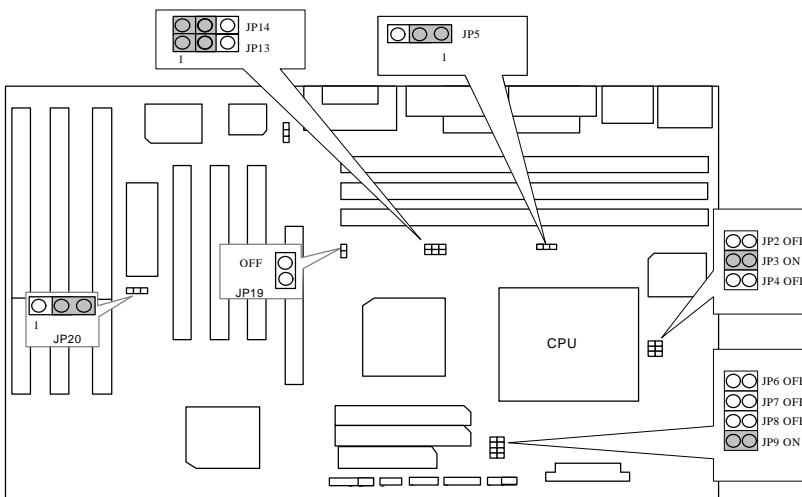

19. AMDK5-PR133

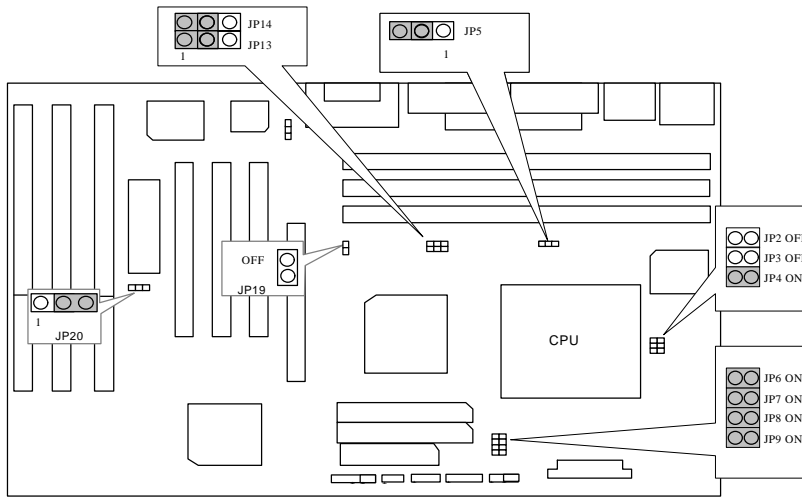

20. AMDK5-PR166

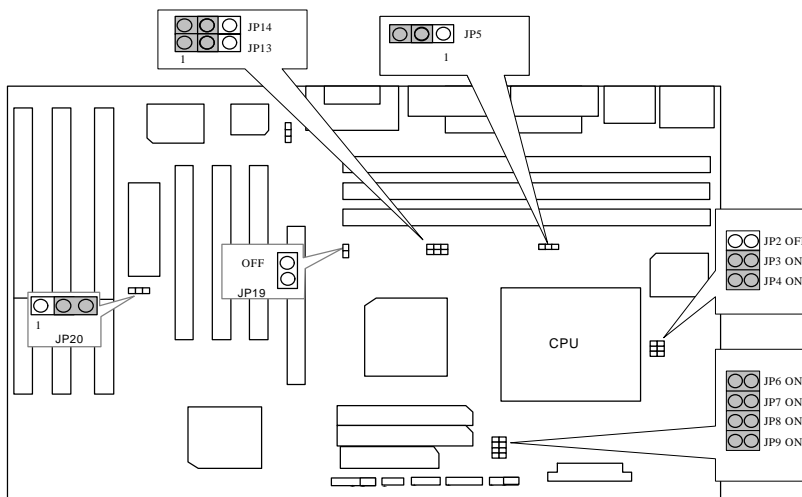

21. AMD-K6/166 (2.9V)

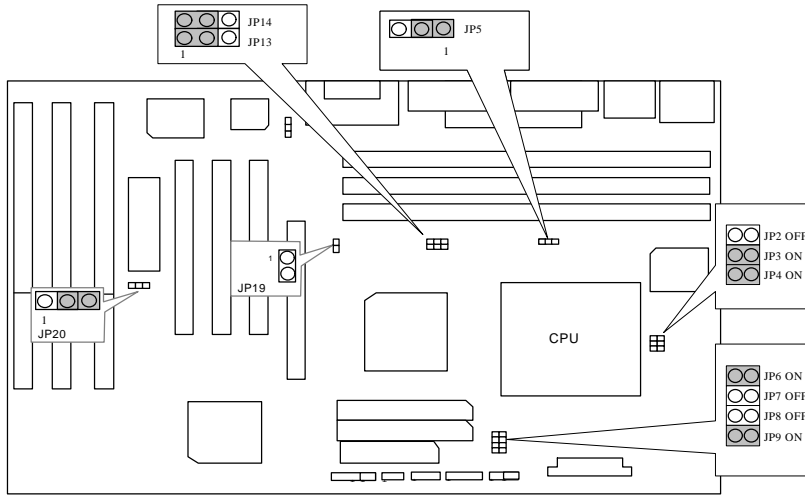

22. AMD-K6/180 (2.9V)

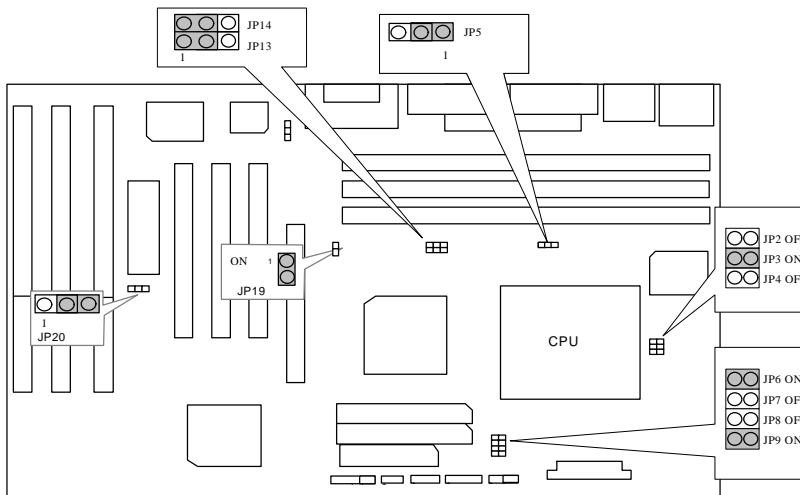

23. AMD-K6/200 (2.9V)

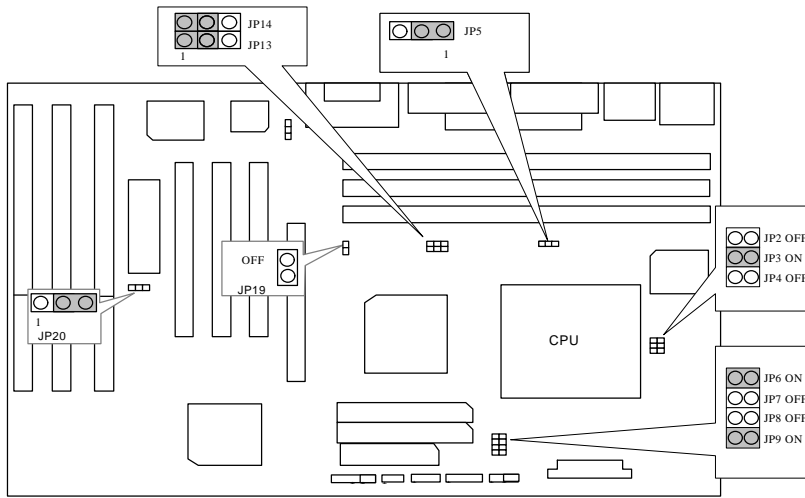

24. AMD-K6/233 (3.2V)

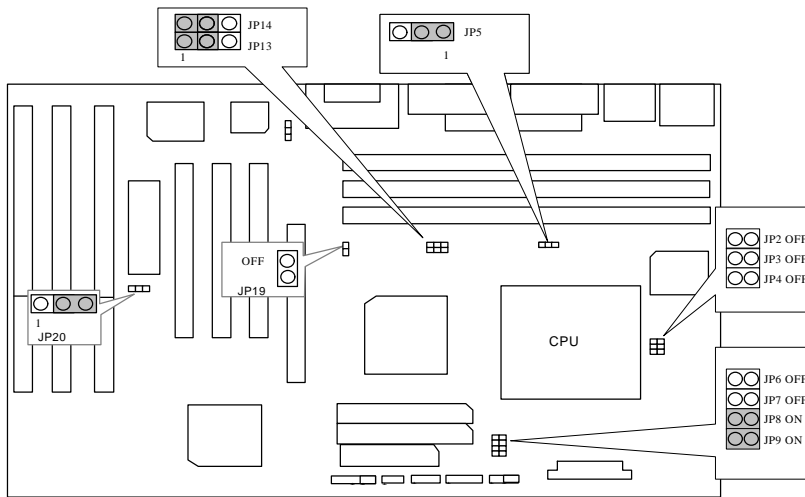

25. Cyrix / IBM 6x86-120 MHz-PR150+

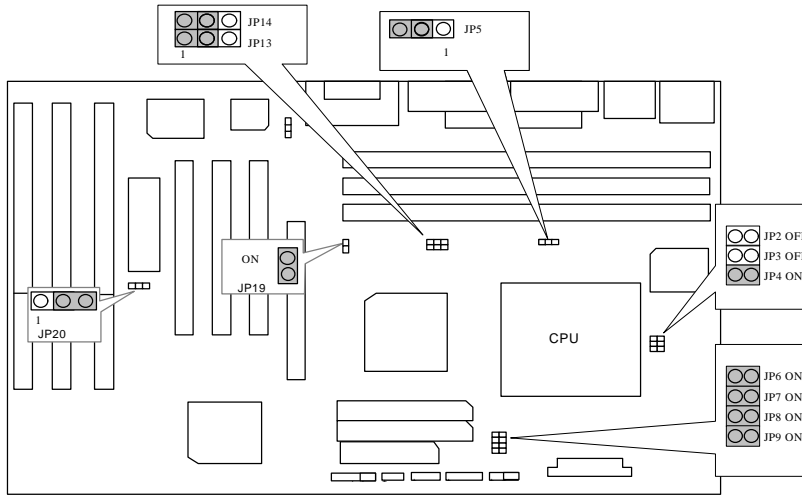

26. Cyrix / IBM 6x86-133 MHz-PR166+

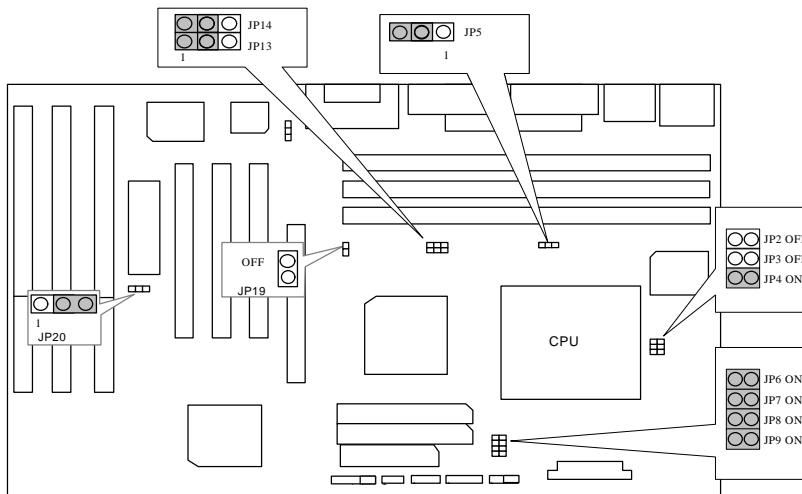

27. Cyrix / IBM 6x86-150 MHz-PR200+

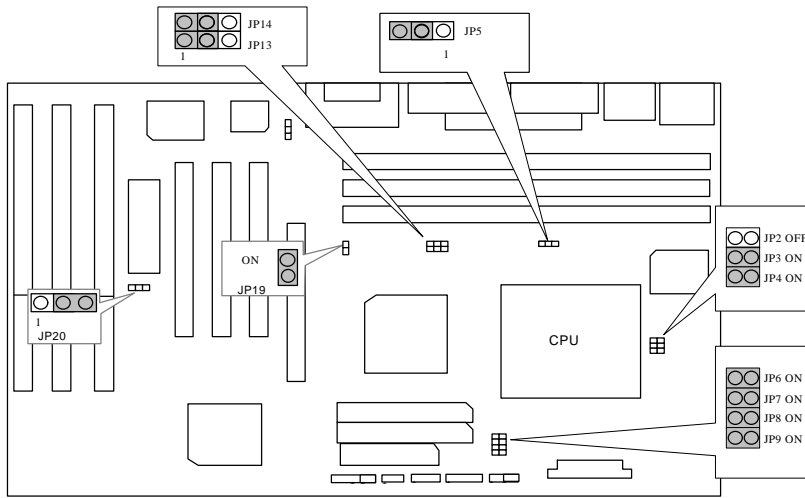

28. Cyrix / IBM 6x86L-PR150+ (2.8V)

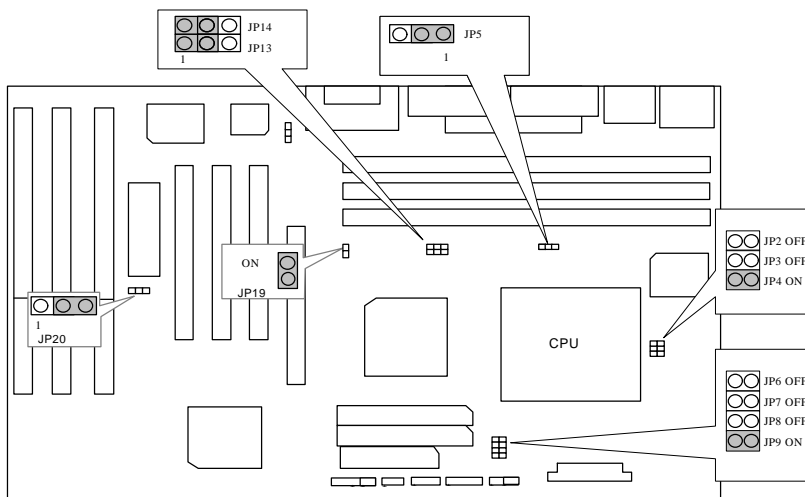

29. Cyrix / IBM 6x86L-PR166+ (2.8V)

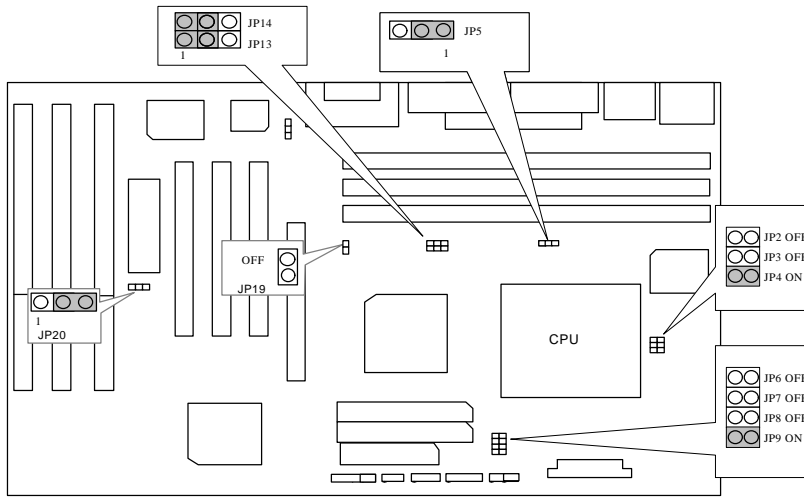

30. Cyrix / IBM 6x86L-PR200+ (2.8V)

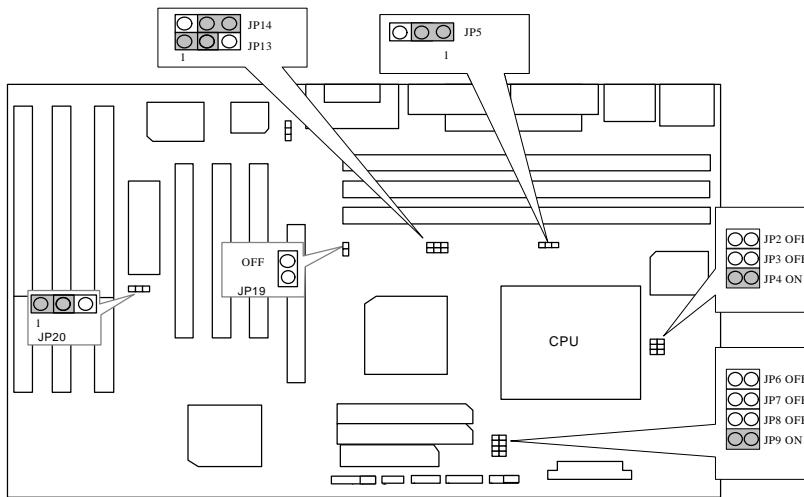

31. Cyrix / IBM 6x86MX-PR150 (60x2.5 2.9V)

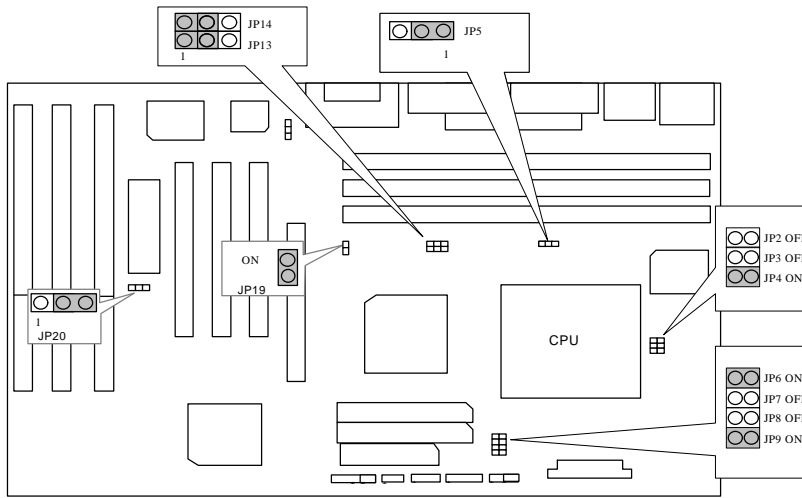

32. Cyrix / IBM 6x86MX-PR166 (60x2.5 2.9V)

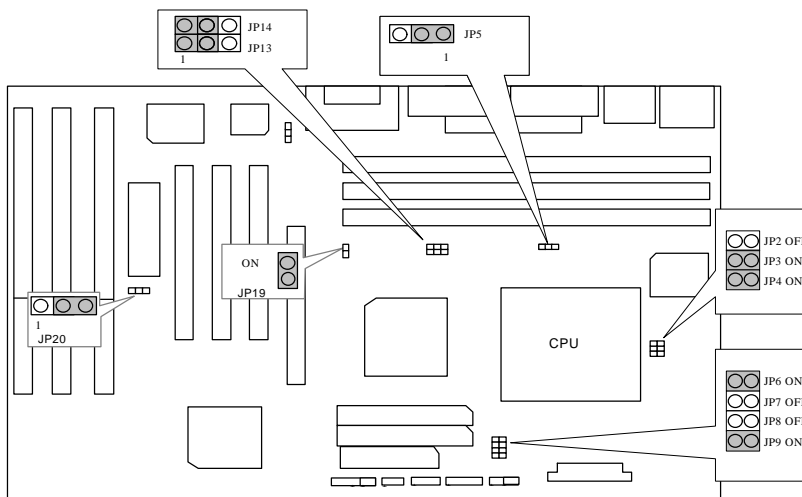

33. Cyrix / IBM 6x86MX-PR166 (66x2 2.9V)

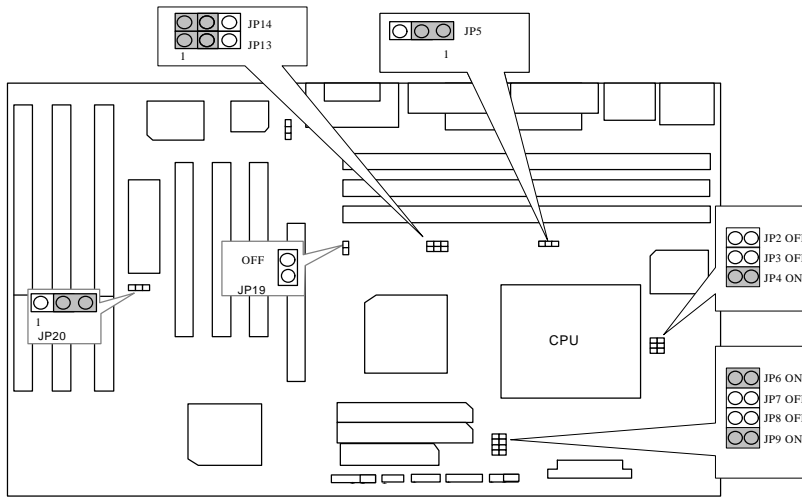

34. Cyrix / IBM 6x86MX-PR200 (60x3 2.9V)

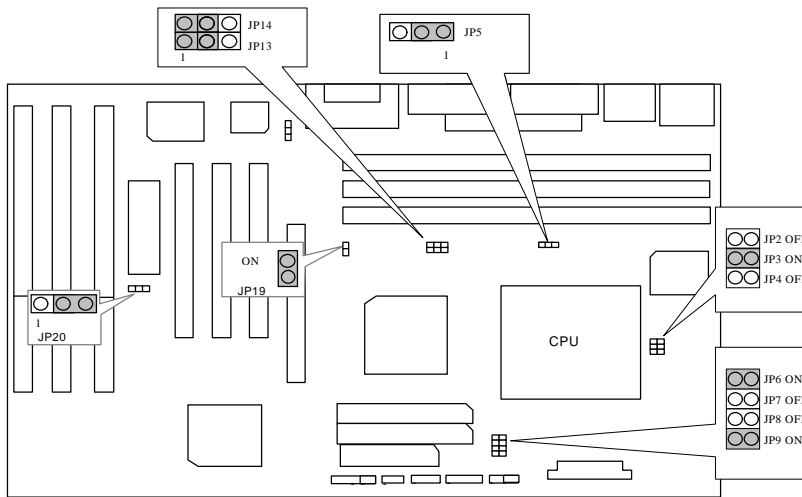

35. Cyrix / IBM 6x86MX-PR200 (66x2.5 2.9V)

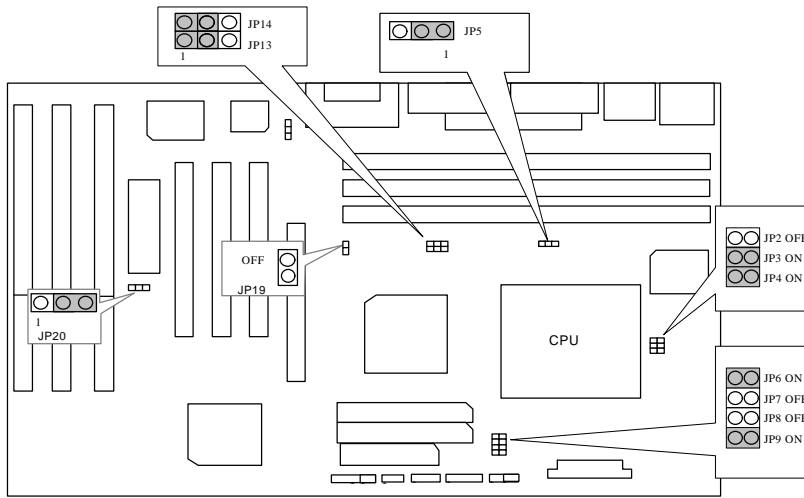

36. Cyrix / IBM 6x86MX-PR200 (75x2 2.9V)

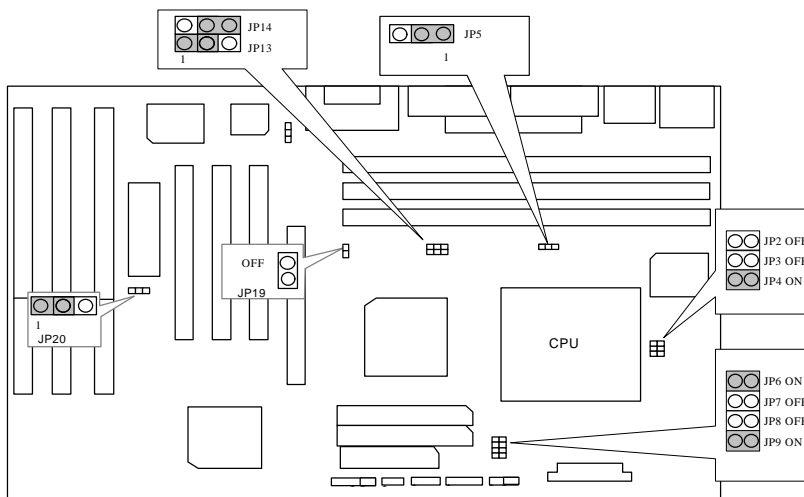

37. Cyrix / IBM 6x86MX-PR200 (66x3 2.9V)

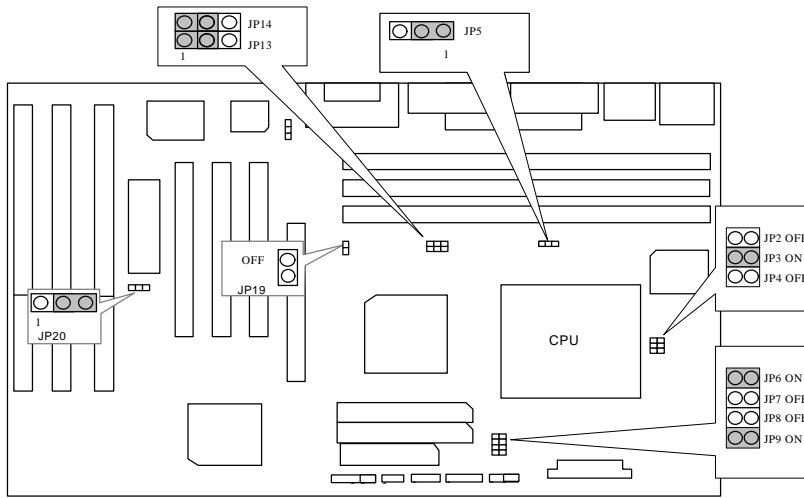

38. Cyrix / IBM 6x86MX-PR233 (75x2.5 2.9V)

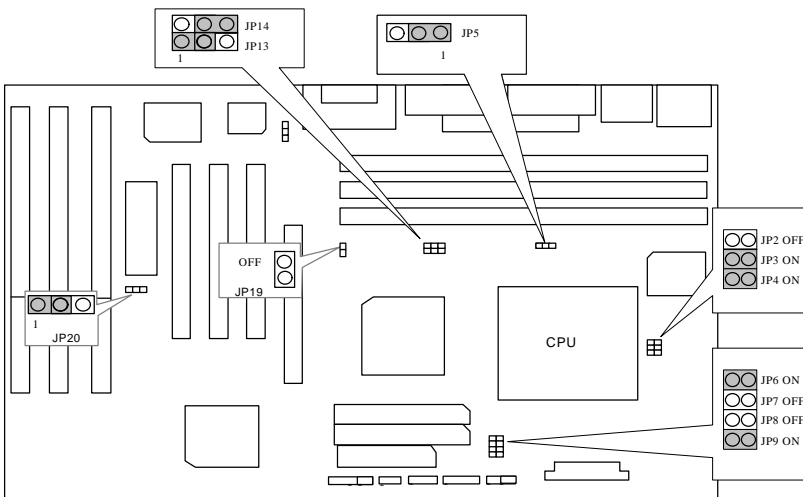

39. Cyrix / IBM 6x86MX-PR233 (83x2 2.9V)

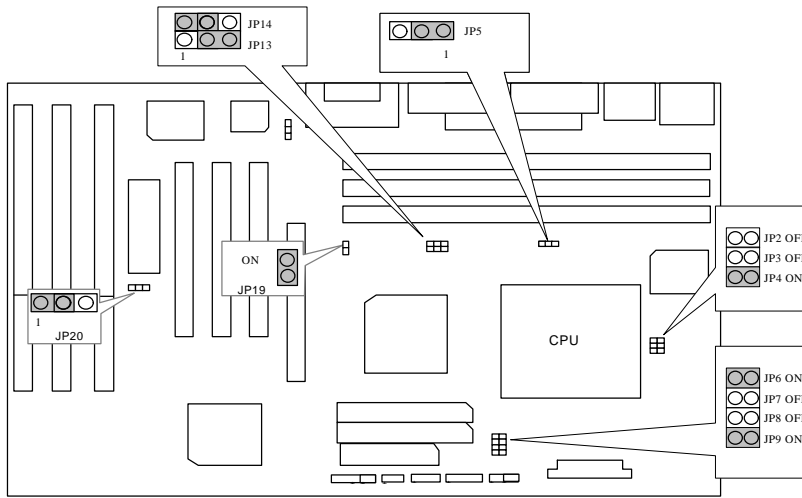

40. Cyrix / IBM 6x86MX-PR266 (66x3.5 2.9V)

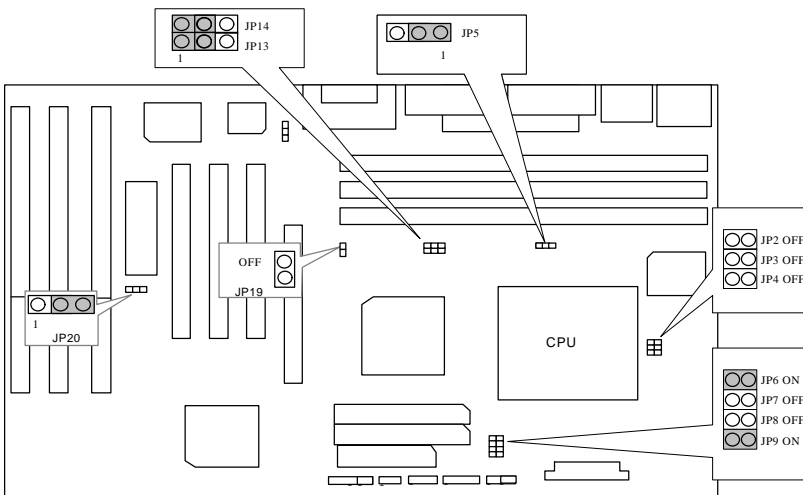

41. Cyrix / IBM 6x86MX-PR266 (75x3 2.9V)

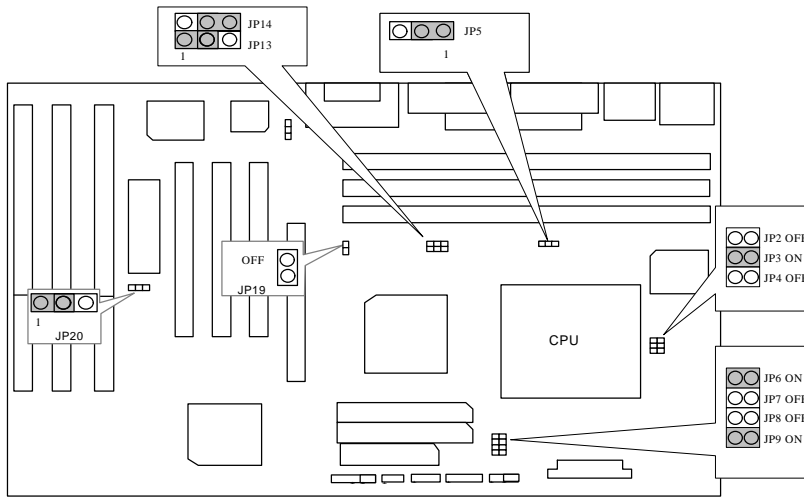

42. Cyrix / IBM 6x86MX-PR266 (83x2.5 2.9V)

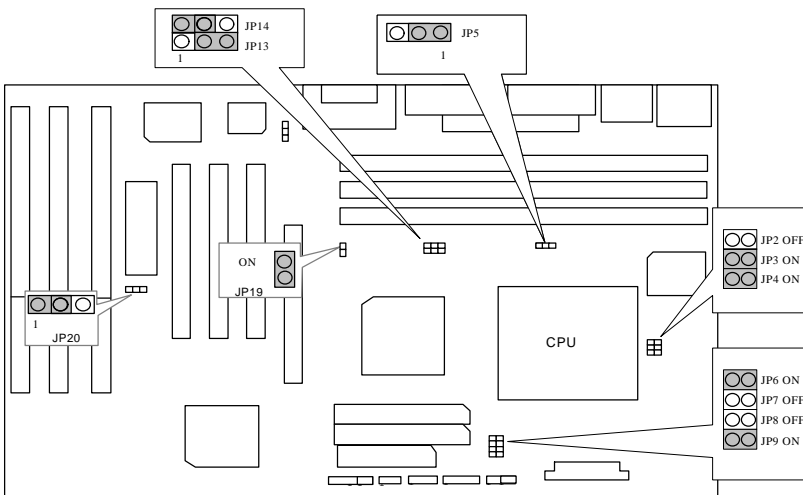

586SGM

II. Quick Inst

SPK : Speaker

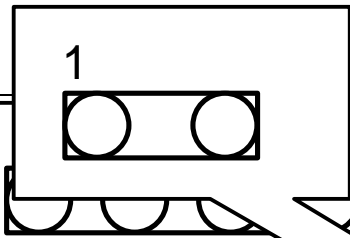

Normal operation

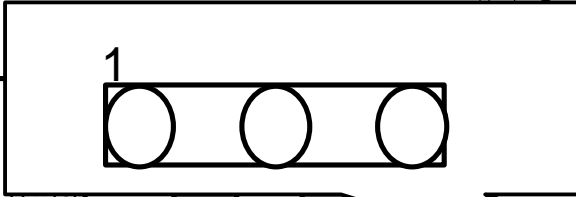

RST : Reset switch

Pin

Pin No	Function
1	LED anode (+)
2	NC
3	LED cathode (-)
4	Data

HD : IDE Hard

Open

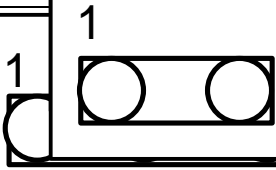

Normal operation

GN : Green Function Switch

Close one time:
Two Option :

1 For system entering Power On/Off

2 system immediately mode (-)

3 Delay 4 Seconds Power Off
4 system Press over 4 Secs

4 LED anode (+)

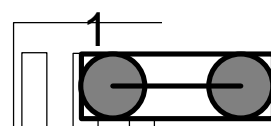

SOFT PWR: Power On/Off Switch

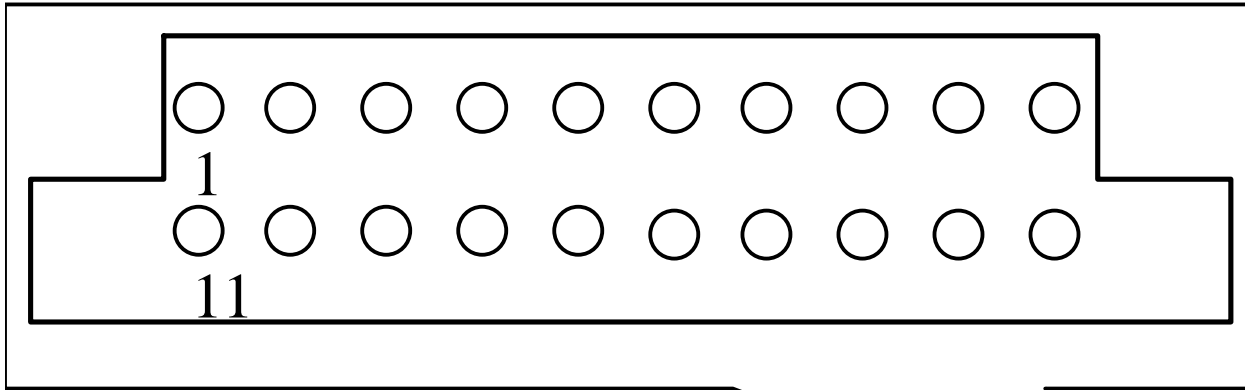

Pin No	Function
JP1 : CPU Cooling Fan Power Connector	
3 5 7 13 15-	GND
4 6 19 20	
12	-12V
CD 1: CD Audio Line In	
8	
9	(Powered by +5V)
14	PS-ON (Soft ON/OFF)

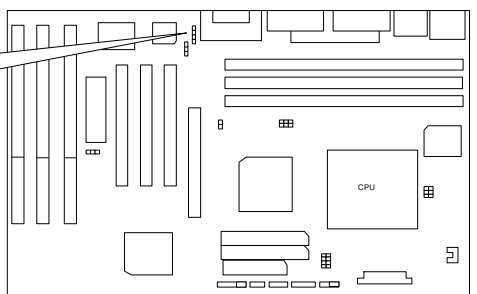
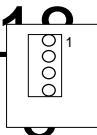
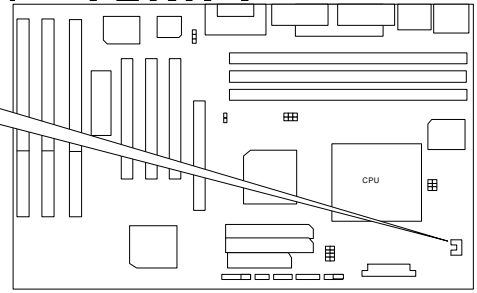

J4 : Sound Function Switch

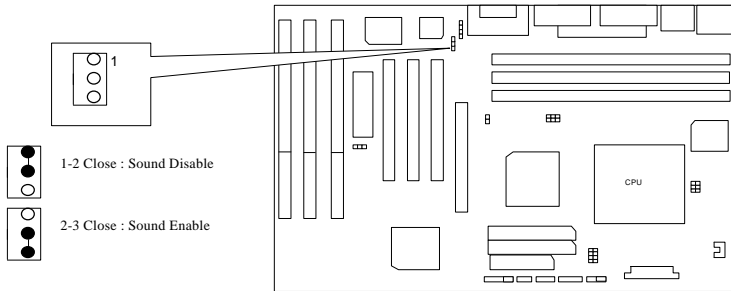

CN1 : USB Port

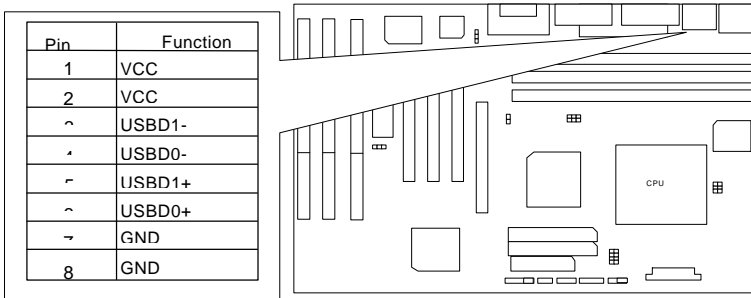

J1 : PS/2 Mouse / Keyboard Connector

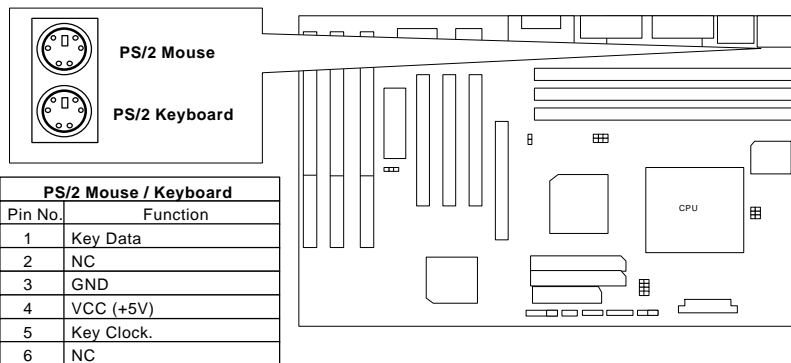

CN3 : COM A

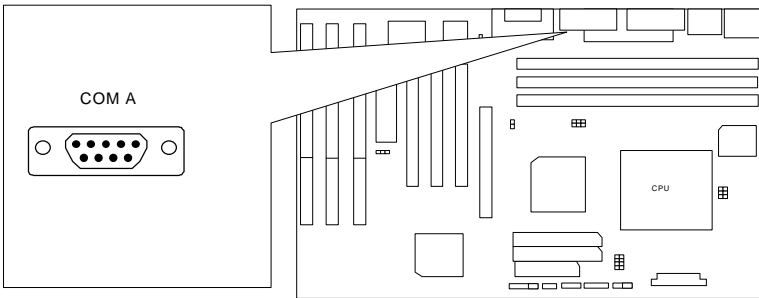

CN2 : COM B

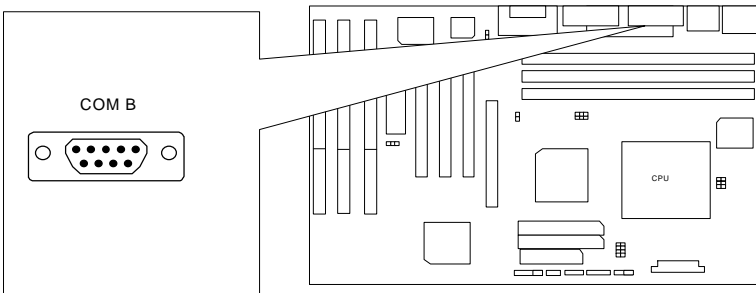

CN4 : LPT PORT

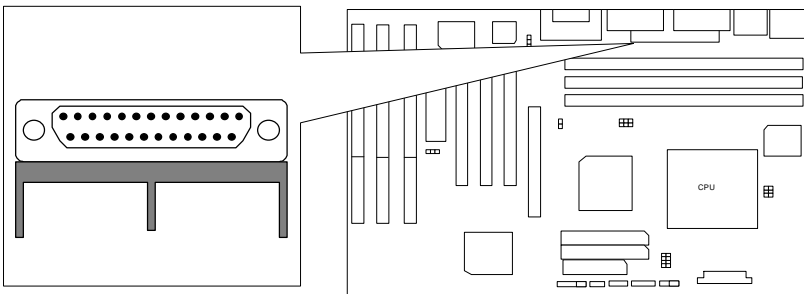

J3 : GAME & AUDIO PORT

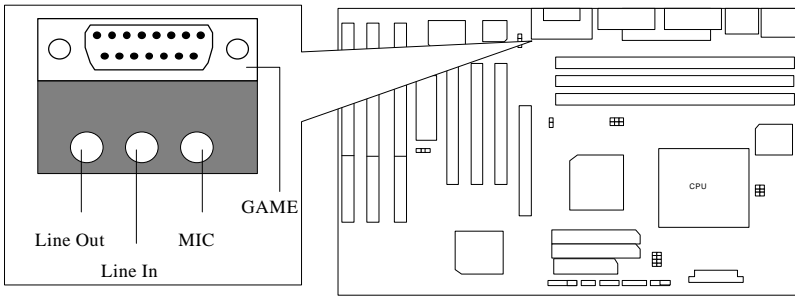

JP12 : FLOPPY PORT

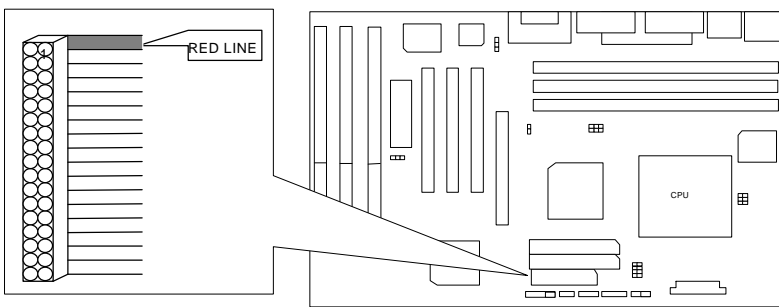

IDE1 : For Primary IDE port

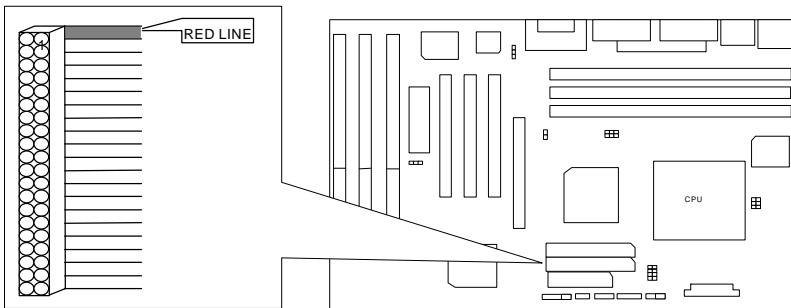

IDE2 : For Secondary IDE port

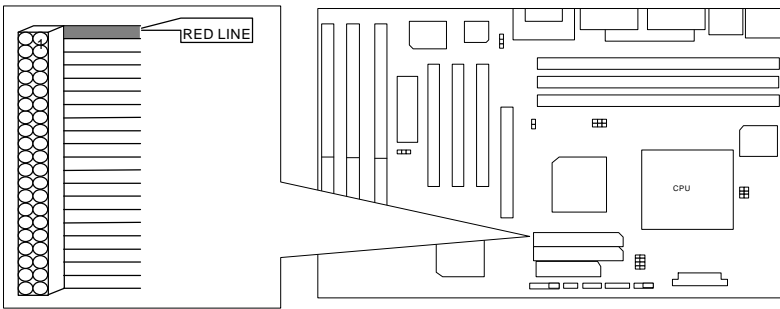

III. Top Performance Test Setting:

Users have to modify the value for each item in chipset features as follow:

Chipset features setup

ROM BIOS / ISA BIOS	
CHIPSET FEATURES SETUP	
AWARD SOFTWARE INC.	
RAS Data Width Refresh	: 5T
RAS Precharge Time	: 3T
RAS to CAS Delay	: 3T
CPU to PCI Post Write	: 4T
ISA Bus Clock Frequency	: 7.159MHz
NA# Enable	: Enabled
SDRAM CAS Latency	: 2T
SDRAM WR Refresh Rate	: X-1-1-1
SDRAM Wait State Control	: 0WS
RAMW# Assertion Timing	: 2T
CAS Precharge Time (EDO)	: 1T
CAS# Data Width for EDO	: 1T
CAS Precharge Time (FP)	: 1T
CAS# Pulse Width for FP	: 1T
Enhanced Memory Write	: Enabled
Read Prefetch Memory DD	: Enabled
CPU to PCI Burst Mem. WR	: Enabled
MA Current Rating	: 8mA
AGP Aperture Size	: 64MB
System BIOS Cacheable	: Enabled
Video BIOS Cacheable	: Enabled
Memory Hole at 15M-16M	: Disabled
Current CPU Fan Speed	: 0 RPM
Current CPU VCore	: 2.84 V
Current +3.3 V	: 3.61 V
Current +5 V	: 5.21 V
Current +12 V	: 12.41 V
ESC : Quit ↑ ↓ → ← : Select Item F1 : Help DEL/PD/LL : Modify F5 : Old Value (Shift)F2 : Color F6 : Load BIOS Defaults F7 : Load Setup Defaults	

** Each value of items as above depends on your hardware configuration : CPU , SDRAM , Cards , etc.
Please modify each value of items If your system does not work properly .

TABLE OF CONTENTS

1. INTRODUCTION..... 1-1

1.1. PREFACE 1-1

1.2. KEY FEATURES 1-1

1.3. PERFORMANCE LIST 1-2

1.4. BLOCK DIAGRAM 1-2

1.5. INTRODUCE THE PCI - BUS 1-3

1.6. FEATURES 1-4

1.7. What is AGP ? 1-5

2. SPECIFICATION 2-1

2.1. HARDWARE 2-1

2.2. SOFTWARE 2-2

2.3. ENVIRONMENT 2-2

3. HARDWARE INSTALLATION 3-1

3.1. UNPACKING 3-1

3.2. MAINBOARD LAYOUT 3-2

3.3. QUICK REFERENCE FOR JUMPERS & CONNECTORS 3-2

3.4. DRAM INSTALLATION 3-3

3.5. SRAM INSTALLATION 3-4

 Sync. SRAM (Pipeline Burst SRAM) 3-4

3.6. CPU INSTALLATION AND JUMPERS SETUP 3-4

3.7. CMOS RTC & ISA CFG CMOS SRAM 3-5

3.8. SPEAKER CONNECTOR INSTALLATION 3-5

3.9. ACPI LED CONNECTOR INSTALLATION 3-5

3.10. HARDWARE RESET SWITCH CONNECTOR INSTALLATION	3-5
3.11. GREEN FUNCTION INSTALLATION.....	3-5
3.12. PERIPHERAL DEVICE INSTALLATION	3-5
4. BIOS CONFIGURATION	4-1
4.1. ENTERING SETUP	4-1
4.2. CONTROL KEYS	4-1
4.3. GETTING HELP.....	4-3
4.3.1. Main Menu.....	4-3
4.3.2. Status Page Setup Menu / Option Page Setup Menu	4-3
4.4. THE MAIN MENU.....	4-3
4.5. STANDARD CMOS SETUP MENU.....	4-5
4.6. BIOS FEATURES SETUP	4-10
4.7. CHIPSET FEATURES SETUP	4-15
4.8. POWER MANAGEMENT SETUP	4-20
4.9. PNP/PCI CONFIGURATION	4-23
4.10. LOAD BIOS DEFAULTS.....	4-25
4.11. LOAD SETUP DEFAULTS.....	4-26
4.12. INTEGRATED PERIPHERALS	4-27
4.13. SUPERVISOR / USER PASSWORD	4-33
4.14. IDE HDD AUTO DETECTION.....	4-34
4.15. SAVE & EXIT SETUP	4-35
4.16. EXIT WITHOUT SAVING.....	4-36

1. INTRODUCTION

1.1. PREFACE

Welcome to use the **586SGM** motherboard. The motherboard is a Pipeline 512 KB CACHE Pentium® Processor based PC/AT compatible system with ISA bus and PCI Local Bus, and has been designed to be the fastest PC / AT system. There are some new features allow you to operate the system with the performance you want.

This manual also explains how to install the motherboard for operation, and how to set up your CMOS CONFIGURATION with BIOS SETUP program.

1.2. KEY FEATURES

- ❑ Pentium® Processor based PC / AT compatible mainboard with PCI / ISA / AGP Bus.
- ❑ 3 PCI Bus slots, 3 ISA Bus slots, 1 AGP slot.
- ❑ Supports Pentium® Processor running at 90-233 MHz, P54CT (150 / 166), MMX (150 / 166 / 200 / 233), P54CTB (150 / 166 / 180 / 200), AMDK5 (PR133 / PR166), AMD-K6(166/180/200 (2.9V) /233 (3.2V)), Cyrix / IBM 6x86-120/ 133/150(PR150+/PR166+/PR200+), Cyrix / IBM 6x86L (PR150+ / PR166+/PR200+(2.8V)), Cyrix / IBM 6x86MX (PR166 (60x2.5 2.9V) / PR200 (66x2.5 2.9V) (75x2 2.9V)/ PR233 (66x3 2.9V) (75x2.5 2.9V)) / PR266 (66x3.5 2.9V) (75x3 2.9V) (83x2.5 2.9V)).
- ❑ Supports true 64 bits CACHE and DRAM access mode.
- ❑ Supports 321 Pins (Socket 7) ZIF white socket on board.
- ❑ Supports 512 KB Pipeline Burst Sync. 2nd Level Cache.
- ❑ CPU L1 / L2 Write-Back cache operation.
- ❑ Supports 8 - 768 MB DRAM memory on board.
- ❑ Supports 3*168 pin 64/72 Bit DIMM module.
- ❑ Supports 2-channel Ultra DMA/33 Enhanced PCI IDE ports for 4 IDE Devices.
- ❑ Supports 2*COM (16550), 1*LPT (EPP / ECP), 1*1.44MB Floppy port.
- ❑ Supports Green function, Plug & Play function.
- ❑ Licensed AWARD BIOS, FLASH RAM for BIOS update.
- ❑ 30.5cm*17cm, ATX Form factor.

- ❑ Supports USB port & PS/2 Mouse and K/B port.
- ❑ Supports 3 steps ACPI LED.

1.3. PERFORMANCE LIST

The following list of performance data is the testing results of some popular benchmark testing programs.

These data are just referred by users, and there is no responsibility for different testing data values gotten by users. (The different Hardware & Software configuration will result in different benchmark testing results.)

- CPU Pentium® Processor MMX-233 MHz , Cyrix 6x86MX-PR233 , AMD K6-233
- DRAM DIMM, SDRAM 32 MB * 1 pcs. Total 32 MB FUJITSU (81117822A-100FN)
- CACHE SIZE 512KB 2nd Level Cache on board.
- DISPLAY S3 ViRGE (86C325)
- STORAGE Onboard IDE port + IBM DHEA-34330 (Ultra DMA/33)
- O.S. Windows95 with Display Driver at 1024 x 768 x 256 colors & SiS IDE Driver (Ultra DMA supported)

◀Windows 95▶-With S3 Virge Display Driver 1024*768*256
-With SiS IDE Driver

Program	Intel-MMX 233MHz (66x3.5)	AMD K6-233 (66x3.5)	Cyrix MX-PR233 (75x2.5)
WinBench 97 Business Database	7.95	8.57	9.37
WinBench 97 Business Publishing	8.74	9.27	10.2
WinBench 97 Business WP/SS	8.49	8.79	9.63
Business Winstone 97	45.4	47.3	50.6
High End Winstone 97	18.9	19.4	20.1

1.4. BLOCK DIAGRAM

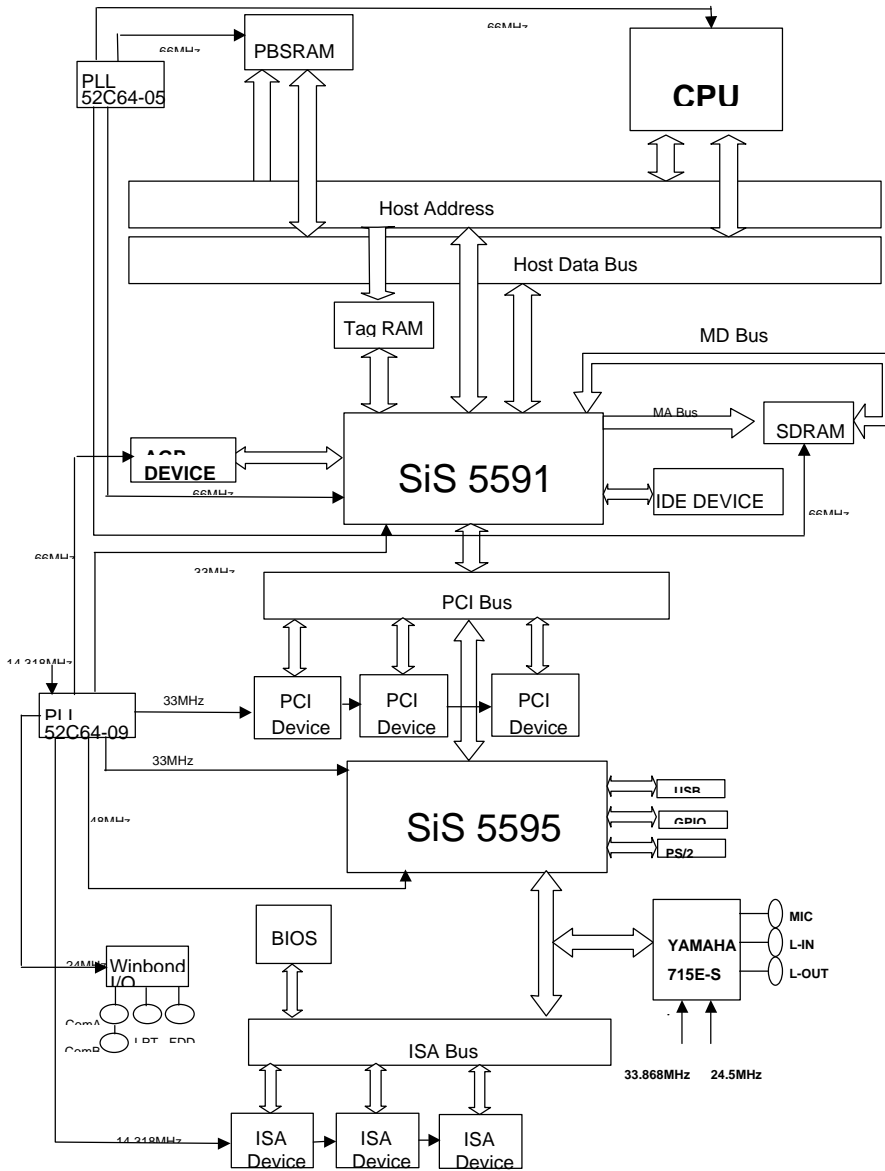

1.5. INTRODUCE THE PCI - BUS

Connecting devices to a CPU local bus can dramatically increase the speed of I/O-bound peripherals with only a slight increase in cost over traditional systems.

This price / Performance point has created a vast market potential for local bus products.

The main barrier to this market has been the lack of an accepted standard for local bus peripherals.

Many mainboard and chipset manufactures developed their own local bus implementations, but they are incompatible with each other.

The VL (Video Electronics Standards Association) local bus and PCI (Peripheral Component Interconnect) bus specification was created to end this confusion.

The PCI - bus standard, under development since Jun. 1992, which is designed to bring workstation-level performance to standard PC platform. The PCI - bus removes many of the bottlenecks that have hampered PC for several years.

On the PCI - bus, peripherals operate at the native speed of the computer system, thus enabling data transfer between peripherals and the system at maximum speed.

This performance is critical for bandwidth-constrained devices such as video, multimedia, mass storage, and networking adapters.

PCI - bus standard provides end-users with a low-cost, extendible and portable local bus design, which will allow system and peripherals from different manufactures to work together.

1.6. FEATURES

- 32 bits bus transfer mode.
- Bus Master or Slave access.
- Memory burst transfer to 132 MB/sec.
- 33 MHz operation speed.
- 10 device loading ability.
- CPU independent.

1.7. What is AGP?

The Accelerated Graphics Port (AGP) is a new port on the Host-To-PCI bridge device that supports an AGP port. The main purpose of the AGP port is to provide fast access to system memory.

The AGP port can be used either as fast PCI port (32-bits at 66MHz vs. 32-bits at 33MHz) or as an AGP port which supports 2x data-rate, a read queue, and side band addressing. When the 2x-data rate is used the port can transmit data at 533Mb/sec ($66.6 \times 2 \times 4$). The read-queue can be used to pipeline reads – removing the effects of the reads-latency. Side band addressing can be used to transmit the data address on a separate line in order to further speed the transaction.

2. SPECIFICATION

2.1. HARDWARE

- CPU
 - Pentium® Processor 90 - 233 MHz, MMX, P54CT, P54CTB, AMDK5(PR133 / PR166), AMD-K6 (166 / 180 / 200 (2.9V) / 233 (3.2V)), Cyrix / IBM 6x86 (PR150+ / PR166+ / PR200+), Cyrix / IBM 6x86L (PR150+/ PR166+/ PR200+(2.8V)), Cyrix / IBM 6x86MX (PR166 (60x2.5 2.9V) / PR200 (66x2.5 2.9V) (75x2 2.9V)/ PR233 (66x3 2.9V) (75x2.5 2.9V) (83x2)/PR266 (66x3.5) (75x3) (83x2.5)
 - 321 pins (socket 7) ZIF white socket on board.
 - 3.52V / 2.0V-3.5V Dual Power Ready.
- COPROCESSOR
 - Included in processor.
- SPEED
 - 60 / 66 / 75/ 83MHz system speed.
 - 60 / 66 MHz AGP-Bus speed.
 - 30 / 33 MHz PCI-Bus speed.
 - 7.5 / 8 MHz AT bus speed.
- DRAM MEMORY
 - 3 banks 168 pins DIMM module socket on board.
 - Use 8 / 16 / 32 / 64 / 128 / 256 MB 60~70 ns DIMM module DRAM.
 - 8 ~ 768 MB DRAM size.
 - Supports 3.3V SDRAM / EDO type DRAM.
 - Supports ECC or Non-ECC type DRAM.
- CACHE MEMORY
 - 16 / 24 / 32 / 64KB L1cache included in CPU.
 - 512 KB 2nd Level cache on board.
 - Supports Write Back cache function for both CPU & on board cache.
- I/O BUS SLOTS
 - 3 xMaster / Slave PCI-BUS Slots.
 - 3 x16 bits ISA BUS Slots.
 - 1 xAGP Slot.

- IDE PORTS
 - 2-channel Ultra DMA/33 Enhanced IDE port on board.(Using IRQ14,15)
 - Supports Mode 3,4 IDE & ATAPI CD – ROM.
- I/O PORTS
 - Supports 2 x16550 COM ports. (Using IRQ4, 3)
 - Supports 1 x EPP/ECP LPT port. (Using IRQ7 or 5 and DMA3 or 1)
 - Supports 1 x 1.44/2.88 MB Floppy port. (Using DMA2 & IRQ6)
 - Supports PS/2 Mouse. (Using IRQ12)
- GREEN FUNCTION
 - Standby & Suspend mode support.
 - Green switch & ACPI LED support.
 - IDE & Display power down support.
 - Monitor all IRQ / DMA / Display / I/O events.
- BIOS
 - 1Mbit FLASH RAM.
 - Supports Plug & Play Function.
- DIMENSION
 - ATX Form Factor, 4 layers PCB.

2.2. SOFTWARE

- BIOS
 - Licensed AWARD BIOS.
 - AT CMOS Setup, BIOS / Chipset Setup, Green Setup, Hard Disk Utility included.
- O.S.
 - Operation with MS-DOS®, Windows®95, WINDOWS™ NT, OS/2, NOVELL and SCO UNIX.

2.3. ENVIRONMENT

- Ambient Temp.
 - 0°C to +50°C (Operating).
- Relative Hum.
 - 0 to +85% (Operating).
- Altitude
 - 0 to 10,000 feet (Operating).
- Vibration
 - 0 to 1,000 Hz.
- Electricity
 - 4.9 V to 5.2 V.
 - Max. 20A current at 5V.

3. HARDWARE INSTALLATION

3.1. UNPACKING

The mainboard package should contain the following:

- The **586SGM** mainboard.
- USER'S MANUAL for mainboard.
- Cable set for IDE ; Floppy & I/O Port .
- Diskette or CD for Mainboard Utility.

The mainboard contains sensitive electric components which can be easily damaged by static electricity, so the mainboard should be left in its original packing until it is installed.

Unpacking and installation should be done on a grounded anti-static mat.

The operator should be wearing an anti static wristband, grounded at the same point as the anti-static mat.

Inspect the mainboard carton for obvious damage. Shipping and handling may cause damage to your board. Be sure there are no shipping and handling damage on the board before proceeding.

After opening the mainboard carton, extract the system board and place it only on a grounded anti-static surface component side up. Again inspect the board for damage.

Press down on all of the socket IC's to make sure that they are properly seated. Do this only on with the board placed on a firm flat surface.

⚠ DO NOT APPLY POWER TO THE BOARD IF IT HAS BEEN DAMAGED.

It is assumed that the chassis is designed for a standard IBM XT/AT mainboard mounting. Place the chassis on the anti-static mat and remove the cover.

Take the plastic clips, Nylon stand-off and screws for mounting the system board, and keep them separate.

3.2. MAINBOARD LAYOUT

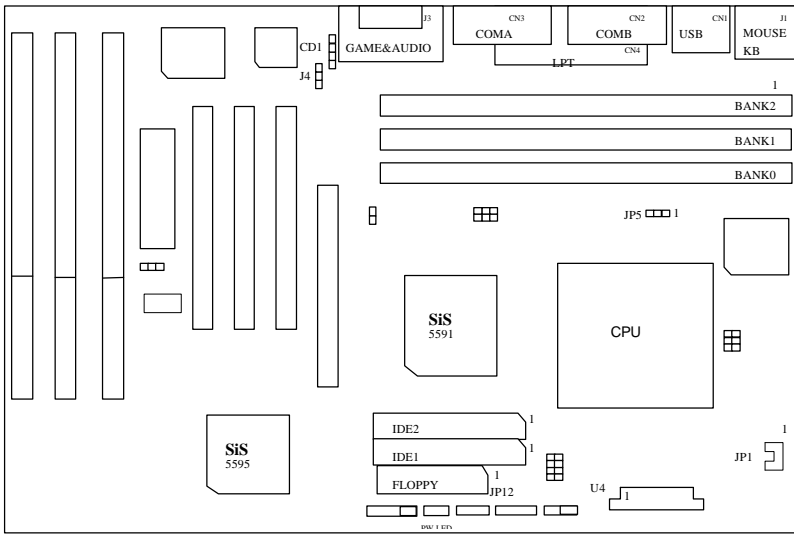

<Figure 3.1>

3.3. QUICK REFERENCE FOR JUMPERS & CONNECTORS

◆ J,1,3,4,CN1,2,3,4,IDE1,IDE2,U4,CD1,JP12	
J1	For PS/2 Mouse & Keyboard Connector
J3	For Game & Audio port
J4	For Sound Function Switch
CN4	For LPT port.
CN3	For Serial port1 (COM A).
CN2	For Serial port2 (COM B).
CN1	For USB port.
IDE1	For Primary IDE port.
IDE2	For Secondary IDE port.
U4	For Power Connector (ATX)
CD1	For CD Audio Line In
JP12	For Floppy port.

◆ PWR LED : 3 steps ACPI LED	
Pin No.	Function
1	LED anode (+).
2	NC.
3	LED cathode (-).

◆ JP5: Single/Dual Voltage Switch	
Pin No.	Function
1-2 Close	Dual Voltage.
2-3 Close	Single Voltage.

◆ CN1 : USB Port	
Pin No.	Function
1	VCC.
2	VCC.
3	USBD1-.
4	USBD0-.
5	USBD1+.
6	USBD0+.
7	GND.
8	GND.

◆ JP1: CPU Cooling FAN Power Connector	
Pin No.	Function
1	GND
2	+12V
3	Signal

3.4. DRAM INSTALLATION

The mainboard can be installed with 4 / 8 / 16 / 32 / 64 / 128 / 256 MB 168 pins DIMM module DRAM, and the DRAM speed must be 67~100 MHz for SDRAM. The DRAM memory system on mainboard consists of bank 0, 1 & bank 2.

Because the 168 pins DIMM module is 64 bits width, using 1 PCS which can match a 64 bits system. The total memory size is 8 MB ~ 768 MB DRAM. The DRAM installation position refer to Figure 3.1, and notice the Pin 1 of DIMM module must match with the Pin 1 of DIMM socket. Insert the DRAM DIMM module into the DIMM socket at Vertical angle. If there is a wrong direction of Pin 1, the DRAM DIMM module couldn't be inserted into socket completely.

3.5. SRAM INSTALLATION

Sync. SRAM (Pipeline Burst SRAM)

If Sync SRAM Chip is installed, it consists of Pipeline Burst 1 Pc 64 K x 64 512KByte.

There is no jumper for cache size setting.

3.6. CPU INSTALLATION AND JUMPERS SETUP

The system speed depends on the frequency of CLOCK GENERATOR. The user can change SW selection to set up the system speed to 60 or 66 or 75 MHz for 3.3V/2.5V Pentium[®] Processor (90-233 MHz) / AMDK5(PR133 / PR166) / AMD-K6(166/180/200(2.9V)/233(3.2V)), Cyrix / IBM 6x86 (PR150+ / PR166+ / PR200+), Cyrix / IBM 6x86L (PR150+ / PR166+ / PR200+ (2.8V)), Cyrix / IBM 6x86MX (PR166 (60x2.5 2.9V) / PR200 (66x2.5 2.9V) (75x2 2.9V) / PR233 (66x3 2.9V) (75x2.5 2.9V) / PR266 (66x3.5 2.9V) (75x3 2.9V) (83x2.5 2.9V)).

The mainboard can use Pentium[®] Processor, P54CT, MMX or P54CTB, AMDK5, AMD-K6, Cyrix / IBM 6x86, CPU, and the CPU speed must match with the frequency of CLOCK GEN. It will cause system hanging up if the CLOCK GEN.'S frequency is faster than CPU's.

- **The CPU is a sensitive electric component and it can be easily damaged by static electricity, so users must keep it away from metal surface when the CPU is installed onto mainboard.**
- **When the user installs the CPU on socket, please notice that the PIN 1 of CPU is in the same corner as the PIN 1 of socket!**
- **Before the CPU is installed, the mainboard must be placed on a flat plane in order to avoid being broken by the pressure of CPU**

installation.

3.7. CMOS RTC & ISA CFG CMOS SRAM

Built-in Real Time Clock (RTC) With 256B CMOS SRAM in SiS5595.

3.8. SPEAKER CONNECTOR INSTALLATION

There is a speaker in AT system for sound purpose. The 4-Pins connector **SPK** is used to connect speaker. The speaker can work well in both direction of connector when it is installed to the connector **SPK** on mainboard.

3.9. ACPI LED CONNECTOR INSTALLATION

This mainboard uses the existing power LED as ACPI LED .The ACPI LED will light on when system is power-on .The ACPI LED is off when the system is power-off. The ACPI LED will blink when system is in Green mode.This connector should be installed to ACPI LED jumper of the mainboard in correct direction.

3.10. HARDWARE RESET SWITCH CONNECTOR INSTALLATION

The RESET switch on panel provides users with HARDWARE RESET function which is almost the same as power-on/off. The system will do a cold start after the RESET switch is pushed and released by user. The RESET switch is a 2 PIN connector and should be installed to **RST** on mainboard.

3.11. GREEN FUNCTION INSTALLATION

There is one jumper for the purpose of power saving, **GN** , to indicate the power saving function . This mainboard uses the existing power LED as ACPI LED . If the ACPI LED is blinking, the system is in green mode. The **GN** switch will force the system into green mode .

3.12. PERIPHERAL DEVICE INSTALLATION

After installation of the device and setup of the jumpers, the mainboard can be mounted into the case and fixed by screw. To complete the mainboard installation, the peripheral devices could be installed now. The basic system needs a display interface card and a storage device.

If a PCI - Bus device is to be installed in the system, any one of three PCI - Bus slots can be used for Slave or Master PCI - Bus device.

After installing the peripheral device, the user should check everything again

and prepare to power-on the system.

4. BIOS CONFIGURATION

Award's BIOS ROM has a built-in Setup program that allows users to modify the basic system configuration.

There're RTC & CMOS SRAM on board; they have a power supply from external battery to keep the DATA inviolate & effective. The RTC is a REAL-TIME CLOCK device, which provides the DATE & TIME to system. The CMOS SRAM is used for keeping the information of system configuration, so the system can automatically boot OS every time. Since the lifetime of internal battery is 5 years, the user can change a new Battery to replace old one after it cannot work.

- Danger of explosion if battery is incorrectly replaced.
- Replace only with the same or equivalent type recommended by the manufacturer.
- Dispose of used batteries according to the manufacturer's instructions.

4.1. ENTERING SETUP

Power ON the computer and press immediately will allow you to enter Setup.

The other way to enter Setup is to power on the computer, when the below message appears briefly at the bottom of the screen during the POST (Power On Self Test), press Key or simultaneously press <Ctrl>, <Alt>, and <Esc> keys.

- Press DEL to enter SETUP.

If the message disappears before you respond and you still wish to enter Setup, restart the system to try again by turning it OFF then ON or pressing the "RESET" bottom on the system case.

You may also restart by simultaneously press <Ctrl>,<Alt>, and keys.

4.2. CONTROL KEYS

Up arrow	Move to previous item.
Down arrow	Move to next item.
Left arrow	Move to the item in the left hand.
Right arrow	Move to the item in the right hand.
Esc key	Main Menu - Quit and not save changes into CMOS Status Page Setup Menu and Option Page Setup Menu - Exit current page and return to Main Menu.
PgUp key	Increase the numeric value or make changes.
PgDn key	Decrease the numeric value or make changes.
F1 key	General help, only for Status Page Setup Menu and Option Page Setup Menu.
F2 key	Change color from total 16 colors.
F3 key	Calendar, only for Status Page Setup Menu.
F4 key	Reserved.
F5 key	Restore the previous CMOS value from CMOS, only for Option Page Setup Menu.
F6 key	Load the default CMOS value from BIOS default table, only for Option Page Setup Menu.
F7 key	Load the default.
F8 key	Reserved.
F9 key	Reserved.
F10 key	Save all the CMOS changes, only for Main Menu.

4.3. GETTING HELP

4.3.1. Main Menu

The on-line description of the highlighted setup function is displayed at the bottom of the screen.

4.3.2. Status Page Setup Menu / Option Page Setup Menu

Press F1 to pop up a small help window that describes the appropriate keys to use and the possible selections for the highlighted item. To exit the Help Window press <Esc>.

4.4. THE MAIN MENU

Once you enter Award BIOS CMOS Setup Utility, the Main Menu (Figure 4.1) will appear on the screen.

The Main Menu allows you to select setup functions and exit choices. Use arrow keys to select among the items and press <Enter> to accept or enter the sub-menu.

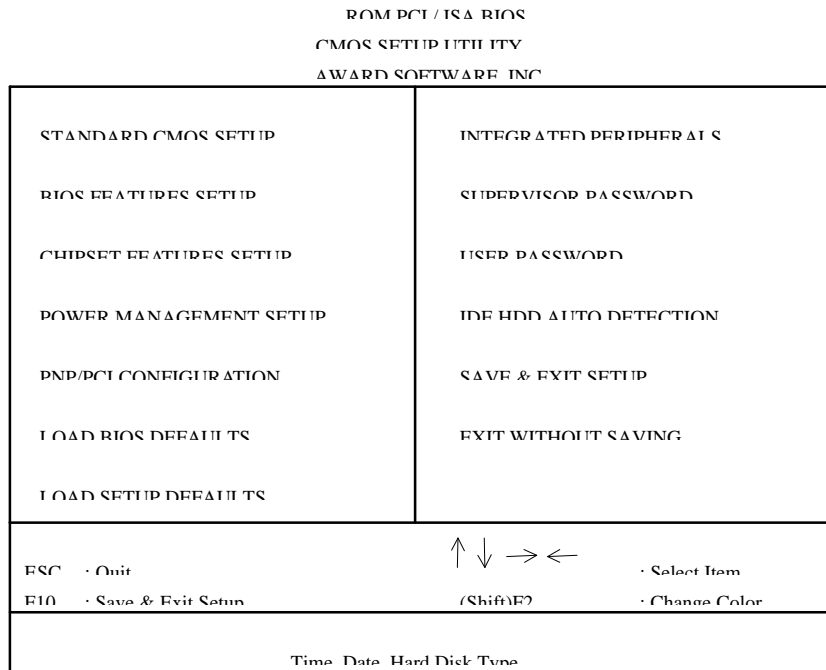

Figure 4.1: Main Menu

- Standard CMOS setup
This setup page includes all the items in a standard compatible BIOS.
- BIOS features setup
This setup page includes all the items of Award special enhanced features.
- Chipset features setup
This setup page includes all the items of chipset special features.
- Power management setup
This setup page includes all the items of Green function features.
- PNP/PCI configuration
This setup page includes all the items of PNP/PCI configuration features.
- Load BIOS defaults
BIOS defaults indicates the most appropriate value of the system parameter which the system would be in safe configuration.
- Load setup defaults
BIOS defaults indicates the most appropriate value of the system parameter which the system would be in safe configuration.
- Integrated Peripherals
This setup page includes all the items of peripherals features.
- Supervisor Password
Change, set, or disable password. It allows you to limit access to the system and Setup, or just to Setup.
- User Password
Change, set, or disable password. It allows you to limit access to the system.
- IDE HDD auto detection
Automatically configure hard disk parameter.
- Save & exit setup
Save CMOS value changes to CMOS and exit setup.
- Exit without save
Abandon all CMOS value changes and exit setup.

4.5. STANDARD CMOS SETUP MENU

The items in Standard CMOS Setup Menu (Figure 4.2) are divided into 9 categories. Each category includes no, one or more than one setup items. Use the arrows to highlight the item and then use the <PgUp> or <PgDn> keys to select the value you want in each item.

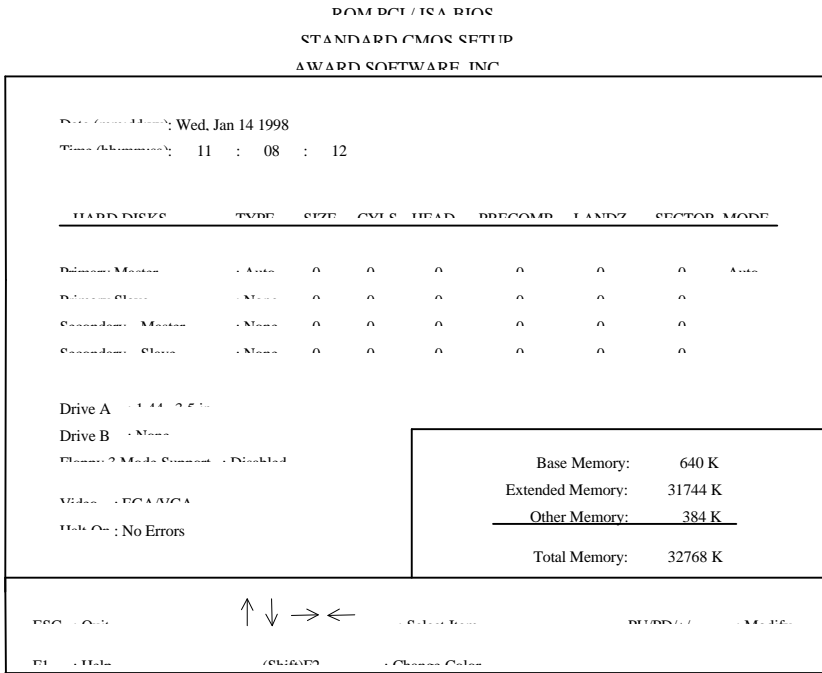

Figure 4.2: Standard CMOS Setup Menu

- Date

The date format is <day>, <date> <month> <year>. Press <F3> to show the calendar.

Day	The day, from Sun to Sat, determined by the BIOS and is display-only
Date	The date, from 1 to 31 (or the maximum allowed in the month)
Month	The month, Jan. through Dec.
Year	The year, from 1994 through 2079

- Time

The time format in <hour> <minute> <second>.

The time is calculated base on the 24-hour military-time clock.

For example, 1 p.m. is 13:00:00.

- Primary HDDs / Secondary HDDs

The category identify the types of hard disk from drive C to drive F 4 devices that has been installed in the computer.

There are three options for definable type; User, Auto and None .

Type User is user-definable; and type Auto means automatically detecting HDD's type and None means No IDE HDD installed.

If you select Type User, related information is asked to be entered to the following items.

Enter the information directly from the keyboard and press <Enter>.

Those information should be provided in the documentation from your hard disk vendor or the system manufacturer.

CYLS.	number of cylinders
HEADS	number of heads
PRECOMP	write precomp
LANDZONE	landing zone
SECTORS	number of sectors

If a hard disk has not been installed select NONE and press <Enter>.

- Drive A type / Drive B type

The category identify the types of floppy disk drive A or drive B that has been installed in the computer.

None	No floppy drive installed
360K, 5.25 in.	5-1/4 inch PC-type standard drive; 360 kilobyte capacity.
1.2M, 5.25 in.	5-1/4 inch AT-type high-density drive; 1.2 megabyte capacity (3-1/2 inch when 3 Mode is Enabled).
720K, 3.5 in.	3-1/2 inch double-sided drive; 720 kilobyte capacity
1.44M, 3.5 in.	3-1/2 inch double-sided drive; 1.44 megabyte capacity.
2.88M, 3.5 in.	3-1/2 inch double-sided drive; 2.88 megabyte capacity.

- Floppy 3 Mode Support (for Japan Area)

Disable	Normal Floppy Drive.
Drive A	Drive A is 3 mode Floppy Drive.
Drive B	Drive B is 3 mode Floppy Drive.
Both	Drive A & B are 3 mode Floppy Drive.

- Video

The category detects the type of adapter used for the primary system monitor that must match your video display card and monitor.

Although secondary monitors are supported, you do not have to select the type in setup.

EGA/VGA	Enhanced Graphics Adapter/Video Graphics Array. For EGA, VGA, SVGA, or PGA monitor adapters
CGA 40	Color Graphics Adapter, power up in 40 column mode
CGA 80	Color Graphics Adapter, power up in 80 column mode
MONO	Monochrome adapter, includes high resolution monochrome adapters

- Halt on

The category determines whether the computer will stop if an error is detected during power up.

NO Errors	The system boot will not be stopped for any error that may be detected
All Errors	Whenever the BIOS detects a non-fatal error, the system will be stopped and you will be prompted
All, But Keyboard	The system boot will not stop for a keyboard error; it will stop for all other errors
All, But Diskette	The system boot will not stop for a disk error; it will stop for all other errors
All, But Disk/Key	The system boot will not stop for a keyboard or disk error; it will stop for all other errors

- Memory

The category is display-only which is determined by POST (Power On Self Test) of the BIOS.

Base Memory

The POST of the BIOS will determine the amount of base (or conventional) memory installed in the system.

The value of the base memory is typically 512 K for systems with 512 K memory installed on the motherboard, or 640 K for systems with 640 K or more memory installed on the motherboard.

Extended Memory

The BIOS determines how much extended memory is present during the POST.

This is the amount of memory located above 1 MB in the CPU's memory address map.

Expanded Memory

Expanded Memory in memory defined by the Lotus / Intel / Microsoft (LIM) standard as EMS.

Many standard DOS applications can not utilize memory above 640, the Expanded Memory Specification (EMS) swaps memory which not utilized by DOS with a section, or frame, so these applications can access all of the system memory.

Memory can be swapped by EMS is usually 64K within 1 MB or memory above 1 MB, depends on the chipset design.

Expanded memory device driver is required to use memory as Expanded Memory.

Other Memory

This refers to the memory located in the 640 to 1024 address space. This is memory that can be used for different applications.

DOS uses this area to load device drivers to keep as much base memory free for application programs. Most use for this area is Shadow RAM.

4.6. BIOS FEATURES SETUP

ROM BIOS / ISA BIOS
BIOS FEATURES SETUP
AWARD SOFTWARE, INC.

<table style="width: 100%; border-collapse: collapse;"> <tr><td>Virus Warning</td><td>: Disabled</td></tr> <tr><td>CDU Internal Cache</td><td>: Enabled</td></tr> <tr><td>External Cache</td><td>: Enabled</td></tr> <tr><td>Quick Power On Self Test</td><td>: Enabled</td></tr> <tr><td>Root Sequence</td><td>: A C SCSI</td></tr> <tr><td>Swap Floppy Drive</td><td>: Disabled</td></tr> <tr><td>Boot Up Floppy Seek</td><td>: Enabled</td></tr> <tr><td>Boot Up NumLock Status</td><td>: On</td></tr> <tr><td>Memory Parity/ECC Check</td><td>: Disabled</td></tr> <tr><td>Typematic Rate Setting</td><td>: Disabled</td></tr> <tr><td>Typematic Rate (Chars/Sec)</td><td>: 6</td></tr> <tr><td>Typematic Delay (Msec)</td><td>: 250</td></tr> <tr><td>Security Option</td><td>: Setup</td></tr> <tr><td>PCI/VGA Palette Snoop</td><td>: Disabled</td></tr> <tr><td>OS Select For DRAM >64MB</td><td>: Non-OS?</td></tr> </table>	Virus Warning	: Disabled	CDU Internal Cache	: Enabled	External Cache	: Enabled	Quick Power On Self Test	: Enabled	Root Sequence	: A C SCSI	Swap Floppy Drive	: Disabled	Boot Up Floppy Seek	: Enabled	Boot Up NumLock Status	: On	Memory Parity/ECC Check	: Disabled	Typematic Rate Setting	: Disabled	Typematic Rate (Chars/Sec)	: 6	Typematic Delay (Msec)	: 250	Security Option	: Setup	PCI/VGA Palette Snoop	: Disabled	OS Select For DRAM >64MB	: Non-OS?	<table style="width: 100%; border-collapse: collapse;"> <tr><td>Video BIOS Shadow</td><td>: Enabled</td></tr> <tr><td>C0000 - C00FF Shadow</td><td>: Disabled</td></tr> <tr><td>C8000 - C8FFF Shadow</td><td>: Disabled</td></tr> <tr><td>D0000 - D0FFF Shadow</td><td>: Disabled</td></tr> <tr><td>D4000 - D4FFF Shadow</td><td>: Disabled</td></tr> <tr><td>D8000 - D8FFF Shadow</td><td>: Disabled</td></tr> <tr><td>DC000 - DCEFF Shadow</td><td>: Disabled</td></tr> </table> <table style="width: 100%; border-collapse: collapse;"> <tr> <td style="width: 20%;">ESC</td> <td style="width: 20%;">Quit</td> <td style="width: 20%; text-align: center;">↑ ↓ → ←</td> <td style="width: 20%;">Select Item</td> </tr> <tr> <td>F1</td> <td>Halt</td> <td>DI/DF/ //</td> <td>Modify</td> </tr> <tr> <td>F5</td> <td>Old Value</td> <td>(Shift)F2</td> <td>Color</td> </tr> <tr> <td>F6</td> <td>Load BIOS Defaults</td> <td></td> <td></td> </tr> <tr> <td>F7</td> <td>Load Setup Defaults</td> <td></td> <td></td> </tr> </table>	Video BIOS Shadow	: Enabled	C0000 - C00FF Shadow	: Disabled	C8000 - C8FFF Shadow	: Disabled	D0000 - D0FFF Shadow	: Disabled	D4000 - D4FFF Shadow	: Disabled	D8000 - D8FFF Shadow	: Disabled	DC000 - DCEFF Shadow	: Disabled	ESC	Quit	↑ ↓ → ←	Select Item	F1	Halt	DI/DF/ //	Modify	F5	Old Value	(Shift)F2	Color	F6	Load BIOS Defaults			F7	Load Setup Defaults		
Virus Warning	: Disabled																																																																
CDU Internal Cache	: Enabled																																																																
External Cache	: Enabled																																																																
Quick Power On Self Test	: Enabled																																																																
Root Sequence	: A C SCSI																																																																
Swap Floppy Drive	: Disabled																																																																
Boot Up Floppy Seek	: Enabled																																																																
Boot Up NumLock Status	: On																																																																
Memory Parity/ECC Check	: Disabled																																																																
Typematic Rate Setting	: Disabled																																																																
Typematic Rate (Chars/Sec)	: 6																																																																
Typematic Delay (Msec)	: 250																																																																
Security Option	: Setup																																																																
PCI/VGA Palette Snoop	: Disabled																																																																
OS Select For DRAM >64MB	: Non-OS?																																																																
Video BIOS Shadow	: Enabled																																																																
C0000 - C00FF Shadow	: Disabled																																																																
C8000 - C8FFF Shadow	: Disabled																																																																
D0000 - D0FFF Shadow	: Disabled																																																																
D4000 - D4FFF Shadow	: Disabled																																																																
D8000 - D8FFF Shadow	: Disabled																																																																
DC000 - DCEFF Shadow	: Disabled																																																																
ESC	Quit	↑ ↓ → ←	Select Item																																																														
F1	Halt	DI/DF/ //	Modify																																																														
F5	Old Value	(Shift)F2	Color																																																														
F6	Load BIOS Defaults																																																																
F7	Load Setup Defaults																																																																

Figure 4.3: BIOS Features Setup

- Virus Warning

If it is set to enable, the category will flash on the screen when there is any attempt to write to the boot sector or partition table of the hard disk drive. The system will halt and the warning message will appear in the mean time. You can run anti-virus program to locate the problem.

The default value is Disabled.

Enabled	Activate automatically when the system boots up causing a warning message to appear when anything attempts to access the boot sector or hard disk partition table.
Disabled	No warning message appears when anything attempts to access the boot sector or hard disk partition table.

- CPU Internal Cache / External Cache

These two categories speed up memory access. However, it depends on CPU / chipset design.

The default value is Enabled.

Enabled	Enable cache function.
Disabled	Disable cache function.

- Quick Power On Self Test

This category speeds up Power On Self Test (POST) after you power on the computer. If it set to Enable, BIOS will skip some check items during POST.

The default value is Enabled.

Enabled	Enable quick POST.
Disabled	Normal POST.

- Boot Sequence

This category determines which drive computer searches first for the disk operating system (i.e., DOS).

The default value is A,C,SCSI.

A,C,SCSI	System will first search for floppy disk drive then hard disk (C) drive and SCSI drive.
C,A,SCSI	System will first search for hard disk (C) drive then floppy disk drive and SCSI drive.
C,CDROM,A	System will first search for hard disk (C) drive then CDROM drive and floppy disk drive.
CDROM,C,A	System will first search for CDROM drive then hard disk (C) drive and floppy disk drive.
D,A,SCSI	System will first search for hard disk (D) drive then floppy disk drive and SCSI drive.
E,A,SCSI	System will first search for hard disk (E) drive then floppy disk drive and SCSI drive.

F,A,SCSI	System will first search for hard disk (F) drive then floppy disk drive and SCSI drive.
SCSI,A,C	System will first search for SCSI drive then floppy disk drive and hard disk (C) drive .
SCSI,C,A	System will first search for SCSI drive and hard disk (C) drive then floppy disk drive .
C only	System will only search for hard disk (C) drive.
LS/ZIP,C	System will first search for floppy disk drive (LS) or ZIP drive then hard disk (C) drive.

- Swap Floppy Drive

The default value is Disabled.

Enabled	Floppy A & B will be swapped under DOS.
Disabled	Floppy A & B will be normal definition.

- Boot Up Floppy Seek

During POST, BIOS will determine if the floppy disk drive installed is 40 or 80 tracks. 360 type is 40 tracks while 720 , 1.2 and 1.44 are all 80 tracks.

The default value is Enabled.

Enabled	BIOS searches for floppy disk drive to determine if it is 40 or 80 tracks. Note that BIOS can not tell from 720, 1.2 or 1.44 drive type as they are all 80 tracks.
Disabled	BIOS will not search for the type of floppy disk drive by track number. Note that there will not be any warning message if the drive installed is 360 .

- Boot Up NumLock Status

The default value is On.

On	Keypad is number keys.
Off	Keypad is arrow keys.

- Memory Parity / ECC Check

The default value is Disabled.

Enabled	Enable Memory Parity / ECC Check.
Disabled	Disable Memory Parity / ECC Check.

- Typematic Rate Setting

The default value is Disabled.

Enabled	Enable Keyboard Typematic rate setting.
Disabled	Disable Keyboard Typematic rate setting.

- Typematic Rate (Chars / Sec)

The default value is 6.

6-30	Set the maximum Typematic rate from 6 chars. per second to 30 chars. per second.
------	--

- Typematic Delay (Msec)

The default value is 250.

250-1000	Set the time delay from first key to repeat the same key in to computer.
----------	--

- Security option

The default value is Setup.

Setup	The system will boot and access to Setup will be denied if the correct password is not entered at the prompt.
System	The system will not boot and access to Setup will be denied if the correct password is not entered at the prompt.

- **To disable security, select PASSWORD SETTING at Main Menu and then you will be asked to enter password. If the user does not type anything and just press <Enter>, it will disable security. Once the security is disabled, the system will boot and you can enter Setup freely.**

- PCI/VGA Palette Snoop

The default value are Disabled.

Enabled	For having Video Card on ISA Bus and VGA Card on PCI Bus.
Disabled	For VGA Card only.

- OS Select For DRAM>64MB

The default value is Non-OS2.

Non-OS2	Using non-OS2 operating system.
OS2	Using OS2 operating system and DRAM>64MB.

- Video BIOS Shadow

It determines whether video BIOS will copied to RAM, however, it is optional from chipset design. Video Shadow will increase the video speed.

The default value is Enable.

Enabled	Video shadow is enabled.
Disabled	Video shadow is disabled.

- C8000 - CFFFF Shadow / D0000 - DFFFF Shadow

These categories determine whether optional ROM will be copied to RAM by 16 byte. The default value are Disabled.

Enabled	Optional shadow is enabled.
Disabled	Optional shadow is disabled.

4.7. CHIPSET FEATURES SETUP

ROM PCI / ISA BIOS
CHIPSET FEATURES SETUP
AWARD SOFTWARE INC

RAS Pulse Width Refresh	: 7T	Custom BIOS Cacheable	: Enabled
RAS Precharge Time	: 5T	Video BIOS Cacheable	: Enabled
RAS to CAS Delay	: 5T	Memory Hole at 15M-16M	: Disabled
CPU to PCI Post Write	: 4T	Current CPU Fan Speed	: 0 RPM
ISA Bus Clock Frequency	: 7.159MHz	Current CPU VCore	: 2.84 V
NA# Enable	: Disabled	Current +3.3 V	: 3.61 V
SDRAM CAS Latency	: 3T	Current +5 V	: 5.21 V
SDRAM WR Refresh Rate	: X-2-2-2	Current +12 V	: 12.41 V
SDRAM Wait State Control	: 1WS		
DRAM# Assertion Timing	: 3T		
CAS Precharge Time (EDO)	: 2T		
CAS# Pulse Width for EDO	: 2T		
CAS Precharge Time (FP)	: 2T		
CAS# Pulse Width for FP	: 2T		
Enhanced Memory Write	: Disabled		
Read Defetch Memory BD	: Disabled	F5C : Quit	↑ ↓ → ← : Select Item
CPU to PCI Burst Mem. WR	: Disabled	F1 : Help	DI/DO/LL : Modify
MA Current Rating	: 8mA	F5 : Old Values (Shift)F2 : Color	
AGP Aperture Size	: 64MB	F6 : Load BIOS Defaults	
		F7 : Load Setup Defaults	

Figure 4.4: Chipset Features Setup

- RAS Pulse width Refresh

The default value is 7T

4T	Set RAS Pulse width Refresh to 4T.
5T	Set RAS Pulse width Refresh to 5T.
6T	Set RAS Pulse width Refresh to 6T.
7T	Set RAS Pulse width Refresh to 7T.

- RAS Precharge Time

The default value is 5T

2T	Set RAS Precharge Time to 2T.
3T	Set RAS Precharge Time to 3T.
4T	Set RAS Precharge Time to 4T.
5T	Set RAS Precharge Time to 5T.

- RAS to CAS Delay

The default value is 5T

2T	Set RAS to CAS Delay to 2T.
3T	Set RAS to CAS Delay to 3T.
4T	Set RAS to CAS Delay to 4T.
5T	Set RAS to CAS Delay to 5T.

- CPU to PCI Post Write

The default value is 4T

3T	Set CPU to PCI Post Write to 3T.
4T	Set CPU to PCI Post Write to 4T.
Disabled	Set CPU to PCI Post Write to Disabled.

- ISA Bus Clock Frequency

The default value is 7.159MHz

PCICLK/3	Set ISA Bus Clock Frequency to PCICLK/3.
PCICLK/4	Set ISA Bus Clock Frequency to PCICLK/4.
7.159MHz	Set ISA Bus Clock Frequency to 7.159MHz.

- NA# Enable

The default value is Disabled

Enabled	Enabled NA#.
Disabled	Disabled NA#.

- SDRAM CAS Latency

The default value is 3T

2T	Set SDRAM CAS Latency to 2T.
3T	Set SDRAM CAS Latency to 3T.

- SDRAM WR Retire Rate

The default value is X-2-2-2

X-1-1-1	Set SDRAM WR Retire Rate to X-1-1-1.
X-2-2-2	Set SDRAM WR Retire Rate to X-2-2-2.

- SDRAM Wait State Control

The default value is 1WS

0WS	Set SDRAM Wait State Control to 0WS.
1WS	Set SDRAM Wait State Control to 1WS.

- RAMW# Assertion Timing

The default value is 3T

2T	Set RAMW# Assertion Timing to 2T.
3T	Set RAMW# Assertion Timing to 3T.

- CAS Precharge Time (EDO)

The default value is 2T

1T	CAS Precharge Time (EDO) 1T.
2T	CAS Precharge Time (EDO) 2T.
1T/2T	CAS Precharge Time (EDO) 1T/2T.

- CAS# Pulse Width for EDO

The default value is 2T.

1T	CAS# Pulse Width (EDO) 1T.
2T	CAS# Pulse Width (EDO) 2T.

- CAS Precharge Time (FP)

The default value is 2T

1T	CAS Precharge Time (FP) 1T.
2T	CAS Precharge Time (FP) 2T.
1T/2T	CAS Precharge Time (FP) 1T/2T.

- CAS# Pulse Width for FP

The default value is 2T

1T	CAS# Pulse Width (FP) 1T.
2T	CAS# Pulse Width (FP) 2T.

- Enhanced Memory Write

The default value is Disabled.

Enabled	Enabled Enhanced Memory Write .
Disabled	Disabled Enhanced Memory Write.

- Read Prefetch Memory RD

The default value is Disabled.

Enabled	Enabled Read Prefetch Memory RD.
Disabled	Disabled Read Prefetch Memory RD.

- CPU to PCI Burst Mem. WR

The default value is Disabled.

Disabled	Disabled CPU to PCI Burst Mem. WR.
Enabled	Enabled CPU to PCI Burst Mem. WR.

- MA Current Rating

The default value is 8mA.

8mA	Set MA Current Rating is 8mA.
16mA	Set MA Current Rating is 16mA.

- AGP Aperture Size

The default value is 64MB.

4MB	Set AGP Aperture Size to 4MB.
8MB	Set AGP Aperture Size to 8MB.
16MB	Set AGP Aperture Size to 16MB.
32MB	Set AGP Aperture Size to 32MB.
64MB	Set AGP Aperture Size to 64MB.
128MB	Set AGP Aperture Size to 128MB.
256MB	Set AGP Aperture Size to 256MB.

- System BIOS Cacheable

The default value is Enabled.

Enabled	Enable System BIOS cacheable.
Disabled	Disable System BIOS cacheable.

- Video BIOS Cacheable

The default value is Enabled.

Enabled	Enable video BIOS cacheable.
Disabled	Disable video BIOS cacheable.

- Memory Hole at 15M-16M

The default value is Disabled .

Disabled	Normal Setting.
Enabled	Set Address=15-16MB relocate to ISA BUS.

- Current CPUFAN Speed

Detect CPU Fan speed status automatically.

- Current CPU Vcore ,+3.3V ,+5V ,+12V

Detect system's 4 positive voltage status automatically.

- Doze Speed (div by)

The default value is 2/8.

1/8 – 8/8	Set Doze Speed from 1/8 to 8/8.
-----------	---------------------------------

- Stdby Speed (div by)

The default value is 1/8.

1/8 – 8/8	Set Stdby Speed from 1/8 to 8/8.
-----------	----------------------------------

- HDD Off After

The default value is Disable.

Disabled	Disable HDD Off After.
1min-15min	Set HDD timer to get into power down mode.

- Doze Mode

The default value is Disable.

Disable	Disable Standby Mode.
10 sec-4 hours	Setup the timer to enter Doze Mode.

- Standby Mode

The default value is Disable.

Disable	Disable Standby Mode.
10 sec-4 hours	Setup the timer to enter Standby Mode.

- Suspend Mode

The default value is Disable.

Disable	Disable Suspend Mode.
10 sec-4 hours	Setup the timer to enter Suspend Mode.

- HDD Ports Activity

The default value is Disabled.

Disabled	Disable HDD Ports Activity.
Enabled	Enable HDD Ports Activity.

- COM Ports Activity

The default value is Disabled.

Disabled	Disable COM Ports Activity.
Enabled	Enable COM Ports Activity.

- LPT Ports Activity

The default value is Disabled.

Disabled	Disable LPT Ports Activity.
Enabled	Enable LPT Ports Activity.

- VGA Activity

The default value is Disabled.

Disabled	Disable VGA Activity.
Enabled	Enable VGA Activity.

- IRQ [3-7,9,A,B,D,E,F] , NMI

The default value is Disabled.

Disabled	Disable this function.
Enabled	Enable monitor IRQ [3-7,9,A,B,D,E,F],NMI for Green event.

- CPUFan Off In Susp.

The default value is Enabled.

Disabled	Disable this function.
Enabled	Stop CPU FAN when entering Suspend mode.

4.9. PNP/PCI CONFIGURATION

ROM PCI / ISA BIOS
PNP/PCI CONFIGURATION
AWARD SOFTWARE INC

Resources Controlled by	· Manual	PCI IDE IRQ Man To	· PCLAUTO
Reset Configuration Data	· Disabled	Primary IDE INT#	· A
IRQ-3 assigned to	· Legacy ISA	Secondary IDE INT#	· B
IRQ-4 assigned to	· Legacy ISA		
IRQ-5 assigned to	· PCI/ISA PnP		
IRQ-7 assigned to	· Legacy ISA		
IRQ-9 assigned to	· PCI/ISA PnP		
IRQ-10 assigned to	· PCI/ISA PnP		
IRQ-11 assigned to	· PCI/ISA PnP		
IRQ-12 assigned to	· PCI/ISA PnP		
IRQ-14 assigned to	· Legacy ISA		
IRQ-15 assigned to	· Legacy ISA		
DMA-0 assigned to	· PCI/ISA PnP		
DMA-1 assigned to	· PCI/ISA PnP		
DMA-3 assigned to	· PCI/ISA PnP		
DMA-5 assigned to	· PCI/ISA PnP		
DMA-6 assigned to	· PCI/ISA PnP		
DMA-7 assigned to	· PCI/ISA PnP		

F5C	· Quit	↑ ↓ → ←	· Select Item
F1	· Help	PU/PD/+/=	· Modify
F5	· Old Values	(Shift)E2	· Color
F6	· Load BIOS Defaults		
F7	· Load Setup Defaults		

Figure 4.6: PCI Slot Configuration

- Resources Controlled By

The default value is Manual.

Manual	Set Resources Controlled By Manual.
Auto	Set Resources Controlled By Auto.

- Reset Configuration Data

The default value is Disabled.

Enabled	Enabled Reset Configuration Data.
Disabled	Disabled Reset Configuration Data.

- IRQ (3,4,5,7,9,10,11,12,14,15), DMA(0,1,3,5,6,7) assigned to

The default value is "Legacy ISA" or "PCI/ISA PnP".

Legacy ISA	The resource is used by Legacy ISA device.
PCI/ISA PnP	The resource is used by PCI/ISA PnP device (PCI or ISA).

- PCI IDE IRQ Map To

PCI-AUTO	Map PCI IDE IRQ to PCI slot automatically.
ISA	Map PCI IDE IRQ to ISA slot.

- Primary/Secondary IDE INT#

A	Set INTA for primary/secondary PCI IDE.
B	Set INTB for primary/secondary PCI IDE.
C	Set INTC for primary/secondary PCI IDE.
D	Set INTD for primary/secondary PCI IDE.

4.10. LOAD BIOS DEFAULTS

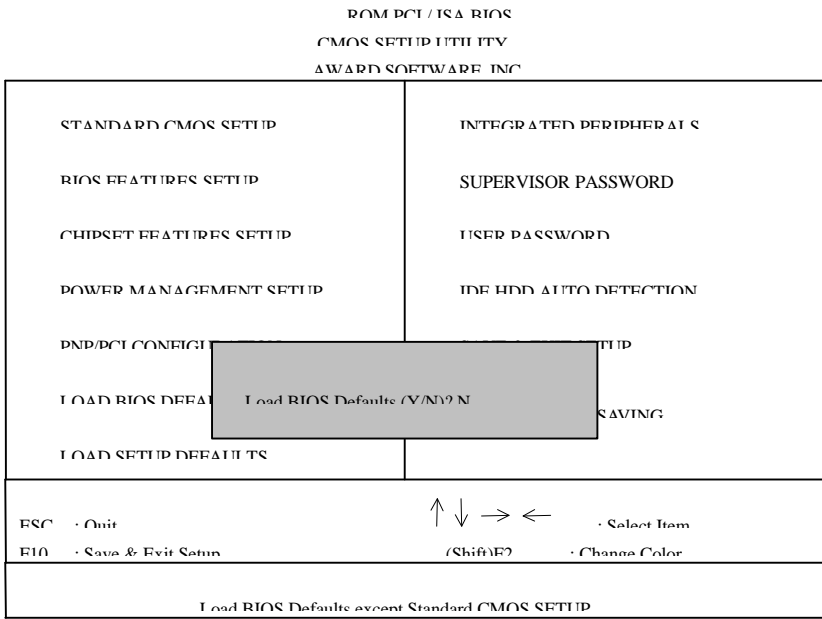

Figure 4.7: Load BIOS Defaults

- Load BIOS Defaults

To load BIOS defaults value to CMOS SRAM, enter "Y". If not, enter "N".

4.11. LOAD SETUP DEFAULTS

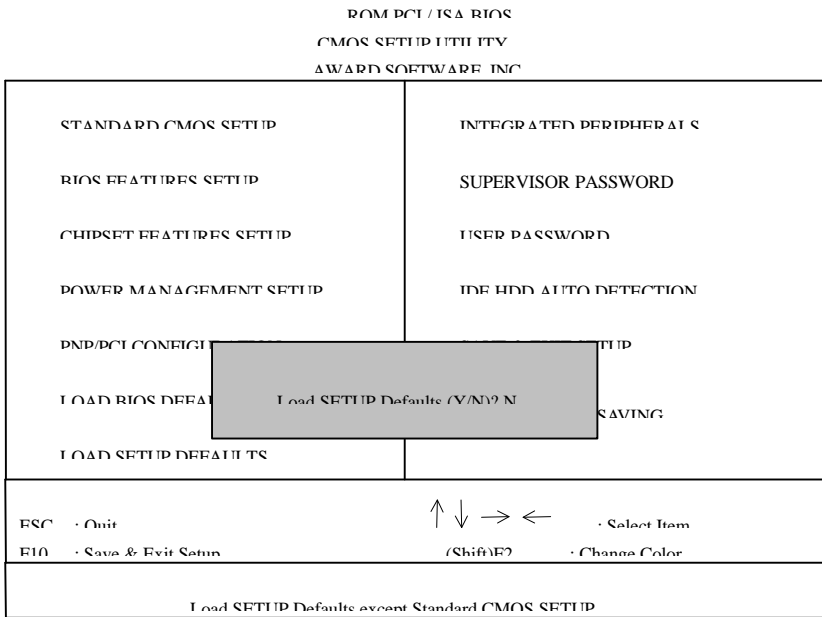

Figure 4.8: Load Setup Defaults

- Load SETUP Defaults

To load SETUP defaults value to CMOS SRAM, enter "Y". If not, enter "N".

- **If there is any problem occurred, loading BIOS DEFAULTS step is recommended.**

4.12. INTEGRATED PERIPHERALS

ROM PCI / ISA BIOS
INTEGRATED PERIPHERALS
AWARD SOFTWARE INC

Internal PCI/IDE	· Both	UISR Controller	· Enabled
IDE Primary Master PIO	· Auto	UISR Keyboard Support	· Disabled
IDE Primary Slave PIO	· Auto	Power Button Over Ride	· Instant Off
IDE Secondary Master PIO	· Auto	Ring Power Up Control	· Enabled
IDE Secondary Slave PIO	· Auto	Power Up by Alarm	· Enabled
Primary Master UltraDMA	· Auto		
Primary Slave UltraDMA	· Auto		
Secondary Master UltraDMA	· Auto		
Secondary Slave UltraDMA	· Auto		
IDE Burst Mode	· Disabled		
IDE Data Port Post Write	· Disabled		
IDE HDD Block Mode	· Enabled	Month Alarm	· NA
Onboard FDD Controller	· Enabled	Day of Month Alarm	· 0
Onboard Serial Port1	· 3F8/IRQ4	Week Alarm	
Onboard Serial Port2	· 2E8/IRQ3	*** SUNDAY MON TUE WED THU FRI SAT ***	
Onboard Parallel Port	· 378/IRQ7	Off Off Off Off Off Off Off	
Onboard Parallel Mode	· ECP/EPP	Time (hh:mm:ss) Alarm	: 0: 0: 0
* ECP Mode Uses DMA	· 3		
**Parallel Port EPP Type	· EPP1.0		

Figure 4.9: Integrated Peripherals

* This item will show up if On board Parallel Mode set to ECP or ECP/EPP.

** This item will show up if On board Parallel Mode set to EPP/SPP or ECP/EPP.

- Internal PCI/IDE

The default value is Both.

Disabled	Disabled Internal PCI/IDE .
Primary	Set Internal PCI/IDE to Primary.
Secondary	Set Internal PCI/IDE to Secondary .
Both	Set Internal PCI/IDE to Both.

- IDE Primary Master PIO (for onboard IDE 1st channel).

The default value is Auto.

Auto	BIOS will automatically detect the IDE HDD Accessing mode.
Mode0~4	Manually set the IDE Accessing mode.

- IDE Primary Slave PIO (for onboard IDE 1st channel).

The default value is Auto.

Auto	BIOS will automatically detect the IDE HDD Accessing mode.
Mode0~4	Manually set the IDE Accessing mode.

- IDE Secondary Master PIO (for onboard IDE 2nd channel).

The default value is Auto.

Auto	BIOS will automatically detect the IDE HDD Accessing mode.
Mode0~4	Manually set the IDE Accessing mode.

- IDE Secondary Slave PIO (for onboard IDE 2nd channel).

The default value is Auto.

Auto	BIOS will automatically detect the IDE HDD Accessing mode.
Mode0~4	Manually set the IDE Accessing mode.

- Primary Master UltraDMA (for onboard IDE 1st channel).

The default value is Auto.

Auto	BIOS will automatically set the IDE HDD to Ultra DMA/33 Mode.
Disabled	Disable Ultra DMA HDD Function.

- Primary Slave UltraDMA (for onboard IDE 1st channel).

The default value is Auto.

Auto	BIOS will automatically set the IDE HDD to Ultra DMA/33 Mode.
Disabled	Disable Ultra DMA HDD Function.

- Secondary Master UltraDMA (for onboard IDE 2nd channel).

The default value is Auto.

Auto	BIOS will automatically set the IDE HDD to Ultra DMA/33 Mode.
Disabled	Disable Ultra DMA HDD Function.

- Secondary Slave UltraDMA (for onboard IDE 2nd channel).

The default value is Auto.

Auto	BIOS will automatically set the IDE HDD to Ultra DMA/33 Mode.
Disabled	Disable Ultra DMA HDD Function.

- IDE Burst Mode

The default value is Disabled.

Enabled	Enable IDE Burst Mode.
Disabled	Disable IDE Burst Mode.

- IDE Data Port Post Write

The default value is Disabled.

Enabled	Enable IDE Data Port Post Write.
Disabled	Disable IDE Data Port Post Write.

- IDE HDD Block Mode

The default value is Enabled.

Enabled	Enable IDE HDD Block Mode.
Disabled	Disable IDE HDD Block Mode.

- Onboard FDD Controller

The default value is Enabled.

Enabled	Enable onboard FDD port.
Disabled	Disable onboard FDD port.

- Onboard Serial Port 1

The default value is 3F8/IRQ4.

Auto	BIOS will automatically setup the port 1 address.
3F8/IRQ4	Enable onboard Serial port 1 and address is 3F8.
2F8/IRQ3	Enable onboard Serial port 1 and address is 2F8.
3E8/IRQ4	Enable onboard Serial port 1 and address is 3E8.
2E8/IRQ3	Enable onboard Serial port 1 and address is 2E8.
Disabled	Disable onboard Serial port 1.

- Onboard Serial Port 2

The default value is 2F8/IRQ3.

Auto	BIOS will automatically setup the port 2 address.
3F8/IRQ4	Enable onboard Serial port 2 and address is 3F8.
2F8/IRQ3	Enable onboard Serial port 2 and address is 2F8.
3E8/IRQ4	Enable onboard Serial port 2 and address is 3E8.
2E8/IRQ3	Enable onboard Serial port 2 and address is 2E8.
Disabled	Disable onboard Serial port 2.

- Onboard Parallel port

The default value is 378/IRQ7.

378/IRQ7	Enable onboard LPT port and address is 378/IRQ7.
278/IRQ5	Enable onboard LPT port and address is 278/IRQ5.
3BC/IRQ7	Enable onboard LPT port and address is 3BC/IRQ7.
Disabled	Disable onboard LPT port.

- Onboard Parallel Mode

The default value is SPP.

SPP	Using Parallel port as Normal Printer Port.
EPP/SPP	Using Parallel port as Enhanced Parallel Port / Normal Printer Port.
ECP	Using Parallel port as Extended Capabilities Port.
ECP/EPP	Using Parallel port as Extended Capabilities Port /Enhanced Parallel Port.

✱ As ECP,ECP/EPP Mode is selected, two options can be defined:

1. ECP Mode use DMA: 3
2. ECP Mode use DMA: 1

✱ ✱ As EPP/SPP, ECP/EPP Mode is Selected, two options can be defined:

1. Parallel Port EPP Type : EPP 1.9
2. Parallel Port EPP Type : EPP 1.7

- USB Controller

The default value is Enabled.

Disabled	Disable USB Controller.
Enabled	Enable USB Controller.

- USB Keyboard Support

The default value is Disabled.

Disabled	Disable USB Keyboard Support.
Enabled	Enable USB Keyboard Support.

- Power Button Over Ride

The default value is Instant Off.

Instant Off	Press Soft PWR switch ON/OFF to POWER ON/OFF
Delay 4 Sec.	Press Soft PWR switch Over 4sec. to POWER OFF.

- Ring Power Up Control

The default value is Enabled.

Disabled	Disable Modem Ring-on .
Enabled	Enable Modem Ring-on .

- Power Up by Alarm

The default value is Disabled.

Disabled	Disable this function.
Enabled	Enable alarm function to POWER ON system.

If Power Up by Alarm is Enabled.

Month Alarm :	NA,1~12
Date of Month Alarm :	0~31
Week Alarm :	*** SUN MON TUE WED THU FRI SAT *** Off Off Off Off Off Off Off
Time (hh: mm: ss) Alarm :	(0~23) : (0~59) : (0~59)

4.13. SUPERVISOR / USER PASSWORD

When you select this function, the following message will appear at the center of the screen to assist you in creating a password.

ENTER PASSWORD

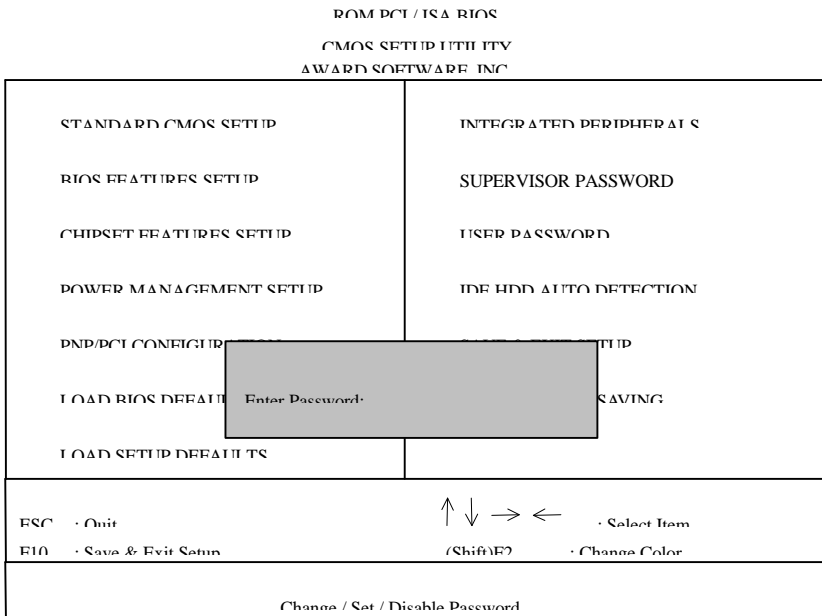

Figure 4.10: Password Setting

Type the password, up to eight characters, and press <Enter>. The password typed now will clear previously entered password from CMOS memory.

You will be asked to confirm the password. Type the password again and press <Enter>.

To disable password, just press <Enter> when you are prompted to enter password. A message will confirm the password being disabled.

Once the password is disabled, the system will boot and you can enter Setup freely.

PASSWORD DISABLED

If you select System at Security Option of BIOS Features Setup Menu, you will be prompted for the password every time the system is rebooted or any time you try to enter Setup.

If you select Setup at Security Option of BIOS Features Setup Menu, you will

be prompted only when you try to enter Setup.

4.14. IDE HDD AUTO DETECTION

```

ROM PCI / ISA BIOS
IDE HDD  AUTO
AWARD SOFTWARE INC

```

HARD DISKS	TYPE	SIZE	CYLS	HEAD	PRECOMP	LANDZ	SECTOR	MODE
Select Primary Master Option (N=Skip)- N								
OPTION	SIZE	CYLS	HEAD	PRECOMP	LANDZ	SECTOR	MODE	
2 (Y)	521	530	32	0	1050	63	LBA	
1	521	1060	16	65535	1050	63	NORMAL	
3	521	530	32	65535	1050	63	LARGE	

Note: Some Oses (like SCO UNIX) must use "NORMAL" for installation
ESC : Skip

Figure 4.11: IDE HDD Auto Detection

Type "Y" will accept the H.D.D. parameter reported by BIOS.

Type "N" will keep the old H.D.D. parameter setup. If the hard disk cylinder NO. is over 1024, then the user can select LBA mode or LARGE mode for DOS partition larger than 528 MB.

4.15. SAVE & EXIT SETUP

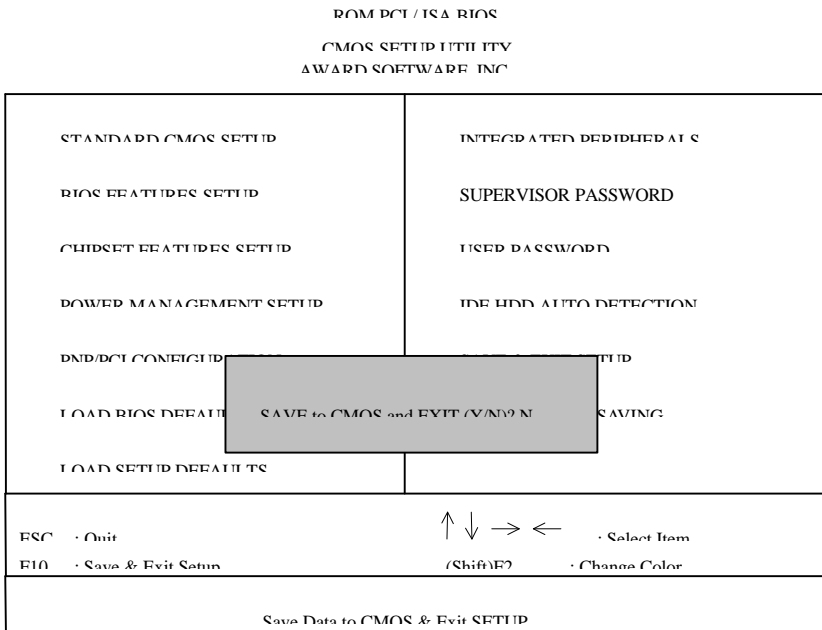

Figure 4.12: Save & Exit Setup

Type "Y" will quit the Setup Utility and save the user setup value to RTC CMOS SRAM.

Type "N" will return to Setup Utility.

4.16. EXIT WITHOUT SAVING

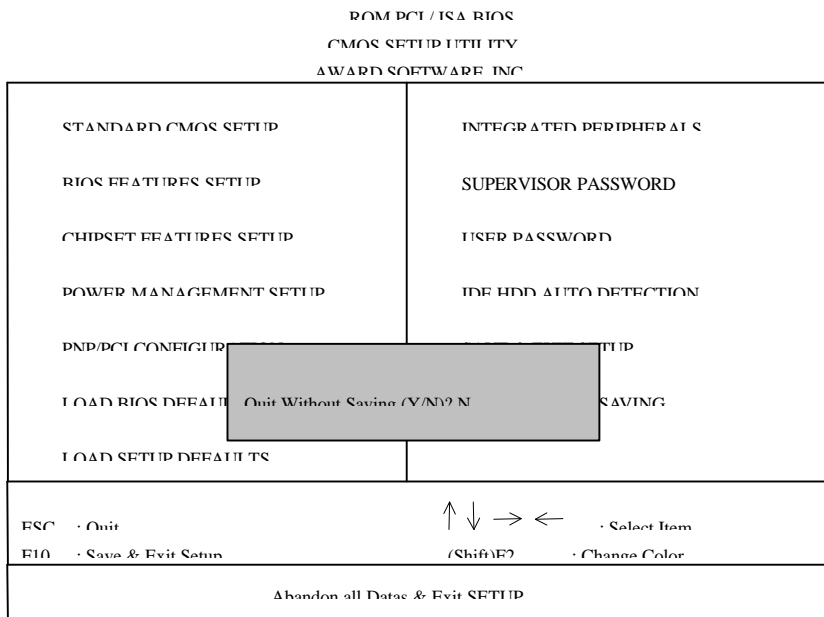

Figure 4.13: Exit Without Saving

Type "Y" will quit the Setup Utility without saving to RTC CMOS SRAM.

Type "N" will return to Setup Utility.

<p align="center">DECLARATION OF CONFORMITY <small>Per FCC Part 15, Section 15.107(a)</small></p> <p align="center">FC</p> <p>Responsible Party Name: G.R.T. INC. Address: 18365 Valley Blvd., Suite#A LA Puente, CA 91744 Phone/Fax No: (818) 854-9338 (818) 854-9339</p> <p>hereby declares that the product</p> <p>Product Name: Mother Board Model Number: G5585GGM</p> <p>Conforms to the following specifications:</p> <p>FCC Part 15, Subpart B, Section 15.107(a) and Section 15.109(a), Class B Digital Device</p> <p>Supplementary Information:</p> <p><small>This device complies with part 15 of the FCC Rules. Operation is subject to the following two conditions: (1) This device may not cause harmful and (2) this device must accept any interference received, including that may cause undesired operation.</small></p> <p>Representative Person's Name: <u>ERIC J. J.</u> Signature: <u>ERIC J. J.</u> Date: <u>Jan. 15, 1998</u></p>
--

FCC Compliance Statement:

This equipment has been tested and found to comply with limits for a Class B digital device , pursuant to Part 15 of the FCC rules. These limits are designed to provide reasonable protection against harmful interference in residential installations. This equipment generates, uses, and can radiate radio frequency energy, and if not installed and used in accordance with the instructions, may cause harmful interference to radio communications. However, there is no guarantee that interference will not occur in a particular installation. If this equipment does

cause interference to radio or television equipment reception, which can be determined by turning the equipment off and on, the user is encouraged to try to correct the interference by one or more of the following measures:

- Reorient or relocate the receiving antenna
- Move the equipment away from the receiver
- Plug the equipment into an outlet on a circuit different from that to which the receiver is connected
- Consult the dealer or an experienced radio/television technician for additional suggestions

You are cautioned that any change or modifications to the equipment not expressly approve by the party responsible for compliance could void Your authority to operate such equipment.

This device complies with Part 15 of the FCC Rules. Operation is subjected to the following two conditions 1) this device may not cause harmful interference and 2) this device must accept any interference received, including interference that may cause undesired operation.

Declaration of Conformity

We, Manufacturer/Importer
(full address)

G.B.T. Technology Trading GMBH
Ausschlagler Weg 41, 1F, 20537 Hamburg, Germany

declare that the product
(description of the apparatus, system, installation to which it refers)

Mother Board
GA-586SGM

is in conformity with
(reference to the specification under which conformity is declared)
in accordance with 89/336 EEC-EMC Directive

- | | | | |
|---|--|--|--|
| <input type="checkbox"/> EN 55011 | Limits and methods of measurement of radio disturbance characteristics of industrial, scientific and medical (ISM) high frequency equipment | <input type="checkbox"/> EN 61000-3-2*
<input checked="" type="checkbox"/> EN60555-2 | Disturbances in supply systems caused by household appliances and similar electrical equipment "Harmonics" |
| <input type="checkbox"/> EN55013 | Limits and methods of measurement of radio disturbance characteristics of broadcast receivers and associated equipment | <input type="checkbox"/> EN61000-3-3*
<input checked="" type="checkbox"/> EN60555-3 | Disturbances in supply systems caused by household appliances and similar electrical equipment "Voltage fluctuations" |
| <input type="checkbox"/> EN 55014 | Limits and methods of measurement of radio disturbance characteristics of household electrical appliances, portable tools and similar electrical apparatus | <input checked="" type="checkbox"/> EN 50081-1
<input checked="" type="checkbox"/> EN 50082-1 | Generic emission standard Part 1: Residual, commercial and light industry
Generic immunity standard Part 1: Residual, commercial and light industry |
| <input type="checkbox"/> EN 55015 | Limits and methods of measurement of radio disturbance characteristics of fluorescent lamps and luminaries | <input type="checkbox"/> EN 55081-2 | Generic emission standard Part 2: Industrial environment |
| <input type="checkbox"/> EN 55020 | Immunity from radio interference of broadcast receivers and associated equipment | <input type="checkbox"/> EN 55082-2 | Generic immunity standard Part 2: Industrial environment |
| <input checked="" type="checkbox"/> EN 55022 | Limits and methods of measurement of radio disturbance characteristics of information technology equipment | <input type="checkbox"/> ENV 55104 | Immunity requirements for household appliances tools and similar apparatus |
| <input type="checkbox"/> DIN VDE 0855
<input type="checkbox"/> part 10
<input type="checkbox"/> part 12 | Cabled distribution systems; Equipment for receiving and/or distribution from sound and television signals | <input type="checkbox"/> EN 50091- 2 | EMC requirements for uninterruptible power systems (UPS) |

CE marking

 (EC conformity marking)

The manufacturer also declares the conformity of above mentioned product with the actual required safety standards in accordance with LVD 73/23 EEC

- | | | | |
|-----------------------------------|---|-------------------------------------|---|
| <input type="checkbox"/> EN 60065 | Safety requirements for mains operated electronic and related apparatus for household and similar general use | <input type="checkbox"/> EN 60950 | Safety for information technology equipment including electrical business equipment |
| <input type="checkbox"/> EN 60335 | Safety of household and similar electrical appliances | <input type="checkbox"/> EN 50091-1 | General and Safety requirements for uninterruptible power systems (UPS) |

Manufacturer/Importer

Signature : Rex Lin

(Stamp)

Date : Jan. 15, 1998

Name : Rex Lin