

**FCC Compliance Statement:**

|   |
|---|
| <p style="text-align: center;"><b>DECLARATION OF CONFORMITY</b><br/><small>Per FCC Part 2 Section 2.107(a)</small></p> <p style="text-align: center;"><b>FCC</b></p> <p>Responsible Party Name: G.B.T. INC.<br/>Address: 18305 Valley Blvd., Suite#A<br/>LA Puente, CA 91744<br/>Phone/Fax No: (818) 854-9338 / (818) 854-9339</p> <p>hereby declares that the product<br/>Product Name: Mother Board<br/>Model Number: GA-6VX7-1394</p> <p>Conforms to the following specifications:<br/>FCC Part 15, Subpart B, Section 15.107(a) and Section 15.109(a),<br/>Class B Digital Device</p> <p><b>Supplementary Information:</b><br/>This device complies with part 15 of the FCC Rules. Operation is subject to the following two conditions: (1) This device may not cause harmful interference and (2) this device must accept any interference received, including that may cause undesired operation.</p> <p>Representative Person's Name: <u>ERIC LU</u><br/>Signature: <u>Eric Lu</u><br/>Date: <u>Mar. 16, 2001</u></p> |
|---|

This equipment has been tested and found to comply with limits for a Class B digital device, pursuant to Part 15 of the FCC rules. These limits are designed to provide reasonable protection against harmful interference in residential installations. This equipment generates, uses, and can radiate radio frequency energy, and if not installed and used in accordance with the instructions, may cause harmful interference to radio communications. However, there is no guarantee that interference will not occur in a particular installation. If this equipment does cause interference to radio or television equipment reception, which can be

determined by turning the equipment off and on, the user is encouraged to try to correct the interference by one or more of the following measures:

- Reorient or relocate the receiving antenna
- Move the equipment away from the receiver
- Plug the equipment into an outlet on a circuit different from that to which the receiver is connected
- Consult the dealer or an experienced radio/television technician for additional suggestions

You are cautioned that any change or modifications to the equipment not expressly approve by the party responsible for compliance could void Your authority to operate such equipment.

This device complies with Part 15 of the FCC Rules. Operation is subjected to the following two conditions 1) this device may not cause harmful interference and 2) this device must accept any interference received, including interference that may cause undesired operation.

## Declaration of Conformity

We, Manufacturer/Importer  
(full address)

**G.B.T. Technology Trading GmbH**  
**Ausschlagler Weg 41, 1F, 20537 Hamburg, Germany**

declare that the product  
( description of the apparatus, system, installation to which it refers)

**Mother Board**  
GA-6VX7-1394

is in conformity with  
(reference to the specification under which conformity is declared)  
in accordance with 89/336 EEC-EMC Directive

- |   |  |  |  |
|---|--|--|--|
| <input type="checkbox"/> EN 55011   | Limits and methods of measurement of radio disturbance characteristics of industrial, scientific and medical (ISM) high frequency equipment                | <input type="checkbox"/> EN 61000-3-2*<br><input checked="" type="checkbox"/> EN60555-2          | Disturbances in supply systems caused by household appliances and similar electrical equipment "Harmonics"   |
| <input type="checkbox"/> EN55013  | Limits and methods of measurement of radio disturbance characteristics of broadcast receivers and associated equipment                                     | <input type="checkbox"/> EN61000-3-3*<br><input checked="" type="checkbox"/> EN60555-3           | Disturbances in supply systems caused by household appliances and similar electrical equipment "Voltage fluctuations"                                  |
| <input type="checkbox"/> EN 55014   | Limits and methods of measurement of radio disturbance characteristics of household electrical appliances, portable tools and similar electrical apparatus | <input checked="" type="checkbox"/> EN 50081-1<br><input checked="" type="checkbox"/> EN 50082-1 | Generic emission standard Part 1: Residual, commercial and light industry<br>Generic immunity standard Part 1: Residual, commercial and light industry |
| <input type="checkbox"/> EN 55015   | Limits and methods of measurement of radio disturbance characteristics of fluorescent lamps and luminaries   | <input type="checkbox"/> EN 55081-2  | Generic emission standard Part 2: Industrial environment   |
| <input type="checkbox"/> EN 55020   | Immunity from radio interference of broadcast receivers and associated equipment   | <input type="checkbox"/> EN 55082-2  | Generic immunity standard Part 2: Industrial environment   |
| <input checked="" type="checkbox"/> EN 55022  | Limits and methods of measurement of radio disturbance characteristics of information technology equipment   | <input type="checkbox"/> ENV 55104   | Immunity requirements for household appliances tools and similar apparatus   |
| <input type="checkbox"/> DIN VDE 0855<br><input type="checkbox"/> part 10<br><input type="checkbox"/> part 12 | Cabled distribution systems; Equipment for receiving and/or <b>distribution</b> from sound and television signals  | <input type="checkbox"/> EN 50091- 2   | EMC requirements for uninterruptible power systems (UPS)   |
| <input checked="" type="checkbox"/> CE marking  |  |               | (EC conformity marking)  |

**The manufacturer also declares the conformity of above mentioned product with the actual required safety standards in accordance with LVD 73/23 EEC**

- |                                   |   |                                     |   |
|-----------------------------------|---|-------------------------------------|---|
| <input type="checkbox"/> EN 60065 | Safety requirements for mains operated electronic and related apparatus for household and similar general use | <input type="checkbox"/> EN 60950   | Safety for information technology equipment including electrical business equipment |
| <input type="checkbox"/> EN 60335 | Safety of household and similar electrical appliances   | <input type="checkbox"/> EN 50091-1 | General and Safety requirements for uninterruptible power systems (UPS)             |

**Manufacturer/Importer**

Signature : Rex Lin  
Name : Rex Lin

(Stamp)

Date: Mar. 16, 2001

**6VX7-1394**  
**Socket 370 Processor Motherboard**

**USER'S MANUAL**

Socket 370 Processor Motherboard  
REV. 5.0 First Edition  
R-50-01-010307



## How This Manual Is Organized

This manual is divided into the following sections:

|   |  |
|---|--|
| <b>1) Revision History</b>                | Manual revision information                  |
| <b>2) Item Checklist</b>                  | Product item list                            |
| <b>3) Features</b>                        | Product information & specification          |
| <b>4) Hardware Setup</b>                  | Instructions on setting up the motherboard   |
| <b>5) Performance &amp; Block Diagram</b> | Product performance & block diagram          |
| <b>6) Suspend to RAM</b>                  | Instructions STR installation                |
| <b>7) BIOS Setup</b>                      | Instructions on setting up the BIOS software |
| <b>8) Appendix</b>                        | General reference                            |



## Table Of Content

|   |      |
|---|------|
| Revision History  | P.1  |
| Item Checklist  | P.2  |
| Summary of Features   | P.3  |
| 6VX7-1394 Motherboard Layout  | P.5  |
| Page Index for CPU Speed Setup/Connectors/Panel and Jumper Definition | P.6  |
| Performance List  | P.32 |
| Block Diagram   | P.33 |
| Suspend to RAM Installation   | P.34 |
| Memory Installation   | P.40 |
| Page Index for BIOS Setup   | P.41 |
| Appendix  | P.69 |

## Revision History

| Revision | Revision Note   | Date     |
|----------|---|----------|
| 5.0      | Initial release of the 6VX7-1394 motherboard user's manual. | Mar.2001 |

The author assumes no responsibility for any errors or omissions that may appear in this document nor does the author make a commitment to update the information contained herein. Third-party brands and names are the property of their respective owners.

Mar. 7, 2001 Taipei, Taiwan, R.O.C



---

## Item Checklist

- The 6VX7-1394 motherboard
- Cable for IDE / floppy device
- Diskettes or CD (TUCD) for motherboard driver & utility
- 6VX7-1394 user's manual

## Features Summary

|                      |   |
|----------------------|---|
| Form Factor          | <ul style="list-style-type: none"> <li>• 30.4 cm x 20.3 cm ATX SIZE form factor, 4 layers PCB.</li> </ul>   |
| CPU                  | <ul style="list-style-type: none"> <li>• Socket 370 processor<br/>Intel Pentium®/100/133MHz FSB, FC-PGA<br/>Intel Celeron™ 66MHz FSB, FC-PGA</li> <li>• L2 cache in CPU(Depend on CPU)</li> </ul>   |
| Chipset              | <ul style="list-style-type: none"> <li>• VT82C694X (VIA Apollo Pro 133A)</li> <li>• VT82C686B</li> </ul>  |
| Clock Generator      | <ul style="list-style-type: none"> <li>• ICS 9248DF-39</li> <li>• 66/100/133 MHz system bus speeds (PCI 33MHz)</li> <li>• 112/124/140/150 MHz system bus speeds (PCI 44MHz) (reserved)</li> </ul>   |
| Memory               | <ul style="list-style-type: none"> <li>• 3 168-pin DIMM sockets.</li> <li>• Supports PC-100 / PC-133 SDRAM and VCM SDRAM</li> <li>• Supports up to 1.5GB(Max)</li> <li>• Supports only 3.3V SDRAM DIMM</li> <li>• Supports 72bit ECC type DRAM integrity mode.</li> </ul>   |
| I/O Control          | <ul style="list-style-type: none"> <li>• VT82C686B</li> </ul>   |
| Slots                | <ul style="list-style-type: none"> <li>• 1 AGP Slot Supports 4X mode &amp; AGP 2.0 compliant</li> <li>• 5 PCI Slot Supports 33MHz &amp; PCI 2.2 compliant</li> <li>• 1 ISA Slot</li> <li>• 1 AMR(Audio Modem Riser)Slot</li> </ul>  |
| On-Board IDE         | <ul style="list-style-type: none"> <li>• 2 IDE bus master (UDMA 33/ ATA 66/ATA100) IDE ports for up to 4 ATAPI devices</li> <li>• Supports PIO mode 3, 4 UDMA33/ATA66/ATA100 IDE &amp; ATAPI CD-ROM</li> </ul>  |
| On-Board Peripherals | <ul style="list-style-type: none"> <li>• 1 floppy port supports 2 FDD with 360K, 720K, 1.2M, 1.44M and 2.88M bytes</li> <li>• 1 parallel ports supports SPP/EPP/ECP mode</li> <li>• 2 serial ports (COM A &amp; COM B)</li> <li>• 4 USB ports</li> <li>• 3 IEEE 1394 port(Internal IEEE1394 port is optional)</li> <li>• 1 IrDA connector for IR</li> </ul> |

To be continued...

---

Features Summary

|                     |  |
|---------------------|--|
| Hardware Monitor    | <ul style="list-style-type: none"><li>• CPU / System fan revolution detect</li><li>• CPU / System temperature detect</li><li>• System voltage detect (Vcore,+3V,+5V,+12V)</li><li>• CPU overheat shutdown detect</li></ul>           |
| PS/2 Connector      | <ul style="list-style-type: none"><li>• PS/2 keyboard interface and PS/2 mouse interface</li></ul>   |
| BIOS                | <ul style="list-style-type: none"><li>• Licensed AMI BIOS, 2M bit flash ROM</li></ul>  |
| Additional Features | <ul style="list-style-type: none"><li>• Supports Wake-on-LAN (WOL)</li><li>• Supports Internal / External modem wake up</li><li>• Includes 3 fan power connectors</li><li>• Poly fuse for keyboard over-current protection</li></ul> |

# 6VX7-1394 Motherboard Layout

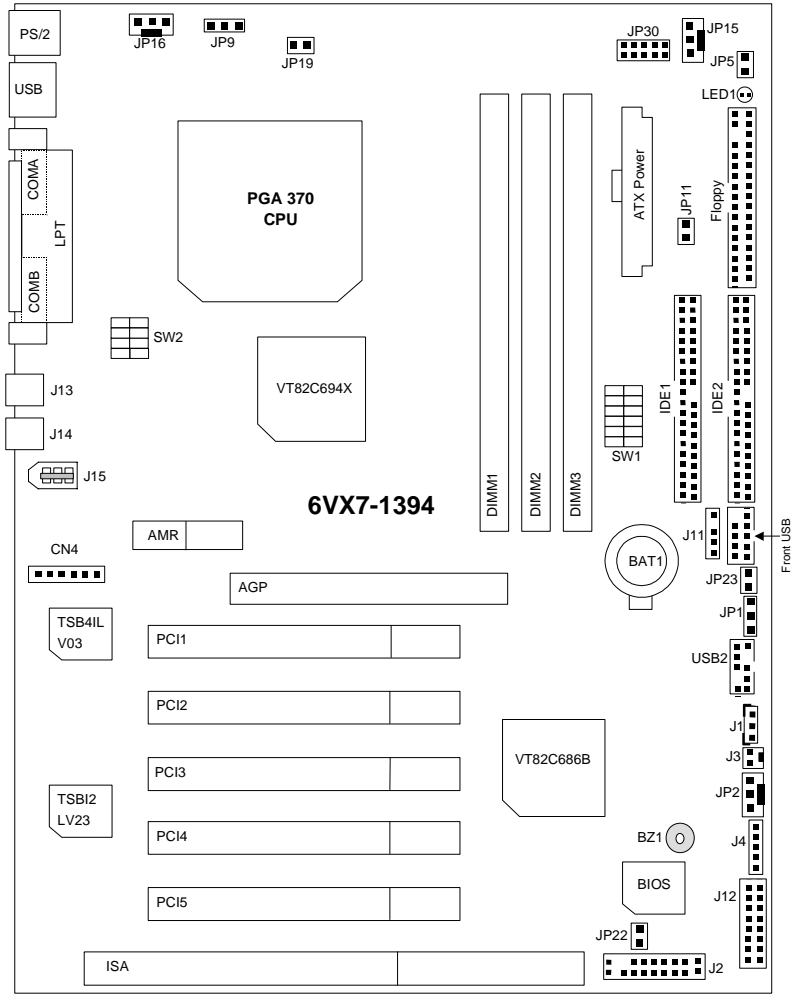

|  Page Index for CPU Speed Setup/Connectors/Panel and Jumper Definition | Page |
|---|------|
| CPU Speed Setup   | P.7  |
| Connectors  | P.17 |
| J13/J14/J15: IEEE 1394 Connector  | P.17 |
| COM A / COM B / LPT Port  | P.17 |
| USB Connector   | P.18 |
| PS/2 Keyboard & PS/2 Mouse Connector  | P.18 |
| JP16 (CPU Fan)  | P.19 |
| JP15 (Power Fan)  | P.19 |
| JP2 (System Fan)  | P.20 |
| ATX Power   | P.20 |
| USB 2 Connector   | P.21 |
| IR Connector  | P.21 |
| Floppy Port   | P.22 |
| IDE 1(Primary)/ IDE 2(Secondary) Port   | P.22 |
| J3 (Ring Power On)  | P.23 |
| J1 (Wake on LAN)  | P.23 |
| JP5 (STR LED Connector) & LED 1 (DIMM LED)  | P.24 |
| Front USB Port [Optional]   | P.24 |
| J11 (SM BUS)  | P.25 |
| CN4 : IEEE 1394 Connect (Optional)  | P.25 |
| Panel and Jumper Definition   | P.26 |
| J2 (2x11 Pins Jumper)   | P.26 |
| JP1 (Clear CMOS Function) [Optional]  | P.27 |
| JP11 (STR Enable)   | P.27 |
| JP19 (Cyril CPU Turbo Function) [Optional]  | P.28 |
| JP9 (USB Device Wake up Selection)  | P.28 |
| JP23 (Case Open)  | P.29 |
| JP22 (BIOS Flash Write Protection)  | P.29 |
| JP30 (Over Voltage CPU Speed up) [Optional]   | P.30 |
| J12 (Front Panel Jumper) [Optional]   | P.30 |
| BAT1 (Battery)  | P.31 |

## CPU Speed Setup

The system bus speed is selectable at 66,100,133MHz and Auto. The user can select the system bus speed (**SW1**) and change the DIP switch (**SW2**) selection to set up the CPU speed for 500MHz – 1GHz and faster processor.

SW1:

O : ON, X: OFF

| CPU  | PCI CLK | 1 | 2 | 3 | 4 | 5 | 6 |
|------|---------|---|---|---|---|---|---|
| Auto | 33.3    | X | X | X | X | O | O |
| 66   | 33.3    | O | O | X | X | X | X |
| 75   | 37.5    | O | O | O | X | X | X |
| 83   | 41.6    | O | O | X | O | X | X |
| 100  | 33.3    | O | X | X | X | X | X |
| 112  | 37.3    | O | X | O | X | X | X |
| 124  | 31      | X | X | X | O | X | X |
| 133  | 33.3    | X | X | X | X | X | X |
| 140  | 35      | X | X | O | O | X | X |
| 150  | 37.5    | X | X | O | X | X | X |

●\* The CPU speed must match with the frequency RATIO. It will cause system hanging up if the frequency RATIO is higher than that of CPU.

SW2:

O : ON, X: OFF

| FREQ. RATIO | DIP SWITCH |   |   |   |
|-------------|------------|---|---|---|
|             | 1          | 2 | 3 | 4 |
| X 3         | O          | X | O | O |
| X 3.5       | X          | X | O | O |
| X 4         | O          | O | X | O |
| X 4.5       | X          | O | X | O |
| X 5         | O          | X | X | O |
| X 5.5       | X          | X | X | O |
| X 6         | O          | O | O | X |
| X 6.5       | X          | O | O | X |
| X 7         | O          | X | O | X |
| X 7.5       | X          | X | O | X |
| X 8         | O          | O | X | X |
| X 8.5       | X          | O | X | X |
| X 9         | O          | X | X | X |
| X 9.5       | X          | X | X | X |
| X 10        | O          | O | O | O |
| X 10.5      | X          | O | O | O |

☞ For Auto Jumper setting:

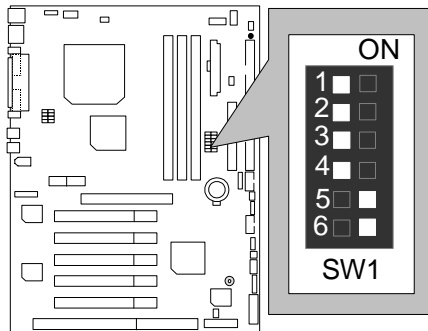

★ Note:

1. If you use 66, 100, 133 MHz CPU, we recommend you to set up your system speed to "Auto" value.
2. We don't recommend you to set up your system speed to 75,83,112, 124, 140,150 MHz because these frequencies are not the standard specifications for CPU, Chipset and most of the peripherals. Whether your system can run under 75,83,112, 124, 140,150 MHz properly will depend on your hardware configurations: CPU, SDRAM, Cards, etc.

1. Celeron™ 533 / 66MHz FSB

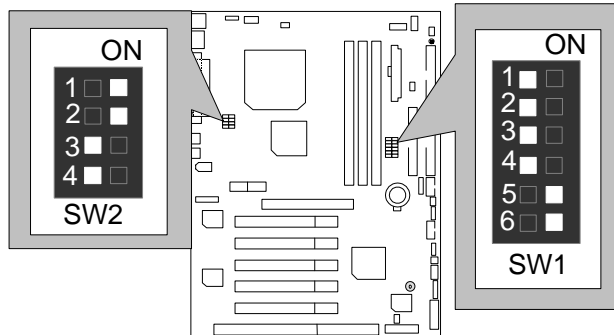

2. Celeron™ 566 / 66 MHz FSB

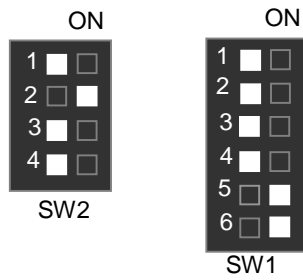

3. Celeron™ 600 / 66 MHz FSB

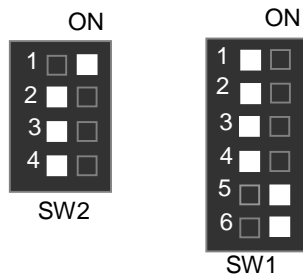



4. Celeron™ 633 / 66 MHz FSB

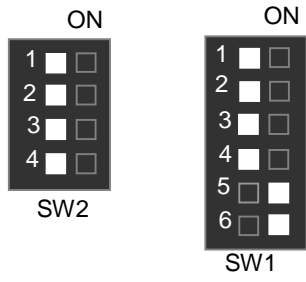

5. Celeron™ 667 / 66 MHz FSB

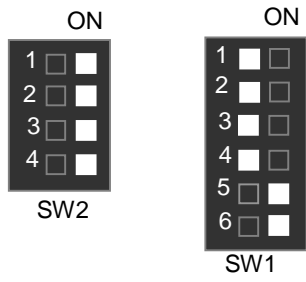

6. Celeron™ 700 / 66 MHz FSB

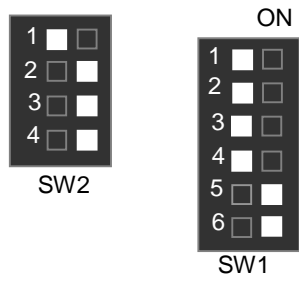

7. Pentium® !!! 500 / 100MHz FSB

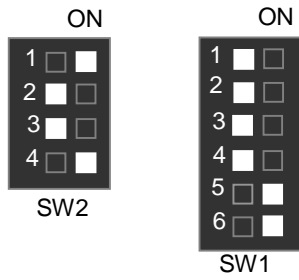

8. Pentium® !!! 550 / 100MHz FSB

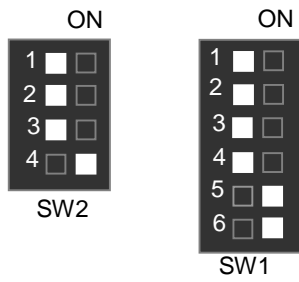

9. Pentium® !!! 600 / 100MHz FSB

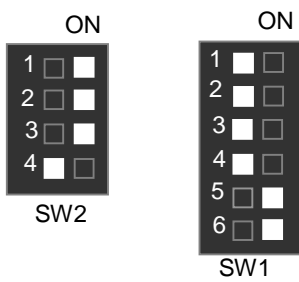

10. Pentium® !!! 650 / 100MHz FSB

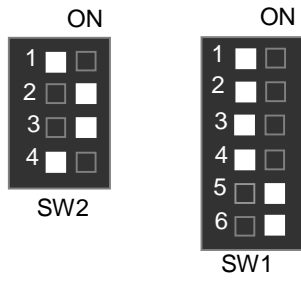

11. Pentium® !!! 700 / 100MHz FSB

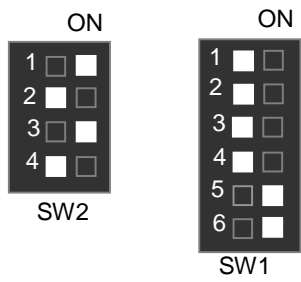

12. Pentium® !!! 750 / 100MHz FSB

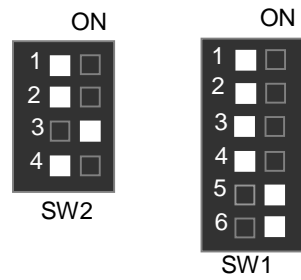

13. Pentium® !!!800 / 100MHz FSB

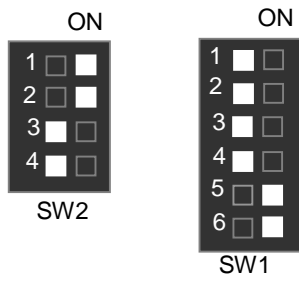

14. Pentium® !!!850 / 100MHz FSB

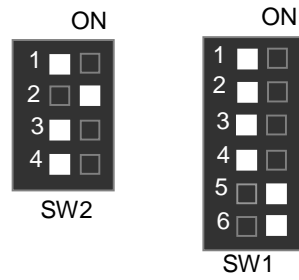

15. Pentium® !!!533 / 133MHz FSB

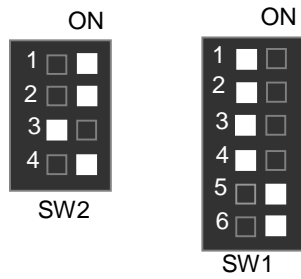

16. Pentium® !!! 600 / 133MHz FSB

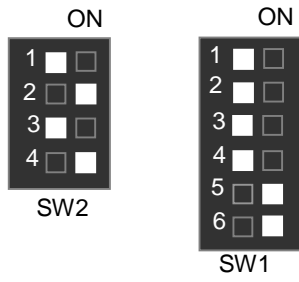

17. Pentium® !!! 667 / 133MHz FSB

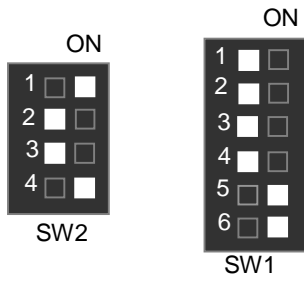

18. Pentium® !!! 733 / 133MHz FSB

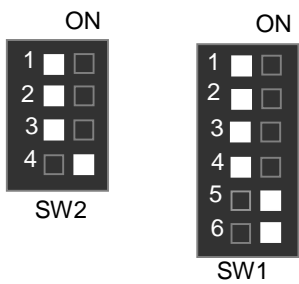

19. Pentium® !!!800 / 133MHz FSB

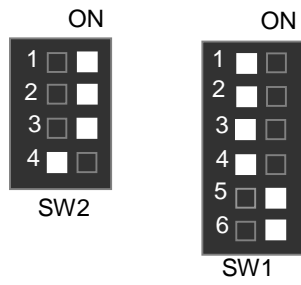

20. Pentium® !!!866 / 133MHz FSB

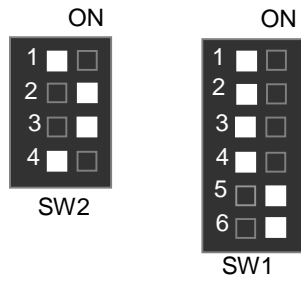

21. Pentium® !!!933 / 133MHz FSB

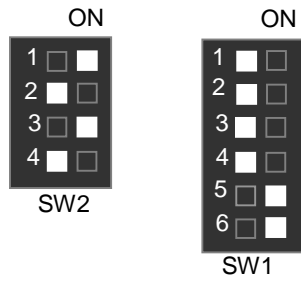

22. Pentium® !!!1GHz / 133MHz FSB

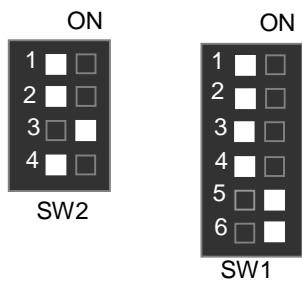

## Connectors

### J13/J14/J15 : IEEE 1394 Connector

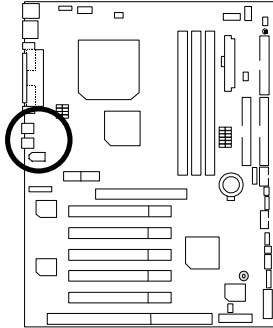

| Pin No. | Definition |
|---------|------------|
| 1       | VP         |
| 2       | VG         |
| 3       | TPB-       |
| 4       | TPB+       |
| 5       | TPA-       |
| 6       | TPA+       |

### COM A / COM B / LPT Port

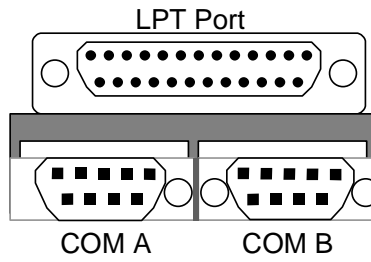
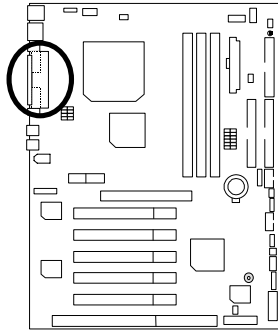



## USB Connector

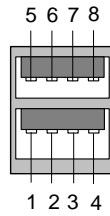
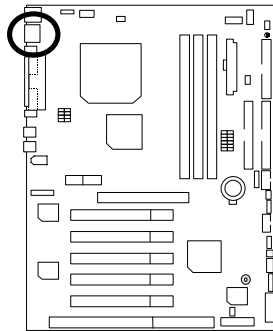

| Pin No. | Definition |
|---------|------------|
| 1       | USB V0     |
| 2       | USB D0-    |
| 3       | USB D0+    |
| 4       | GND        |
| 5       | USB V1     |
| 6       | USB D1-    |
| 7       | USB D1+    |
| 8       | GND        |

## PS/2 Keyboard &amp; PS/2 Mouse Connector

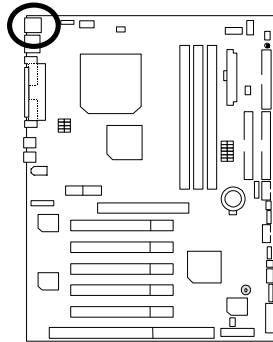

PS/2 Mouse

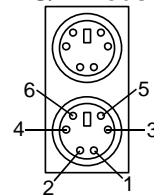

PS/2 Keyboard

| PS/2 Mouse/ Keyboard |            |
|----------------------|------------|
| Pin No.              | Definition |
| 1                    | Data       |
| 2                    | NC         |
| 3                    | GND        |
| 4                    | VCC(+5V)   |
| 5                    | Clock      |
| 6                    | NC         |

### JP16: CPU Fan

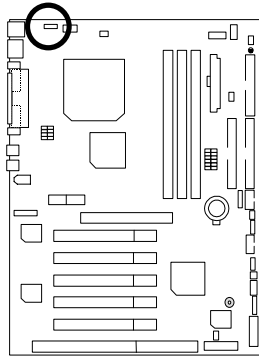

| Pin No. | Definition |
|---------|------------|
| 1       | GND        |
| 2       | +12V       |
| 3       | SENSE      |

### JP15: Power Fan

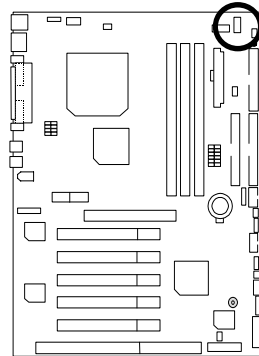

| Pin No. | Definition |
|---------|------------|
| 1       | GND        |
| 2       | +12V       |
| 3       | NC         |

## JP2: System Fan

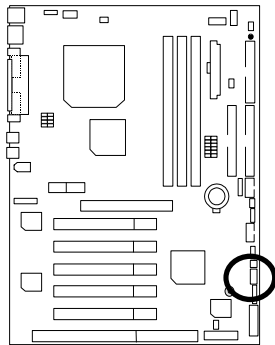

| Pin No. | Definition |
|---------|------------|
| 1       | GND        |
| 2       | +12V       |
| 3       | SENSE      |

## ATX Power

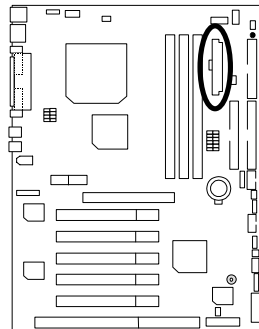

| Pin No.        | Definition         |
|----------------|--------------------|
| 3,5,7,13,15-17 | GND                |
| 1,2,11         | 3.3V               |
| 4,6,19,20      | VCC                |
| 10             | +12V               |
| 12             | -12V               |
| 18             | -5V                |
| 8              | Power Good         |
| 9              | 5V SB stand by+5V  |
| 14             | PS-ON(Soft On/Off) |

USB 2 Connector

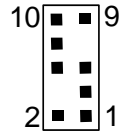
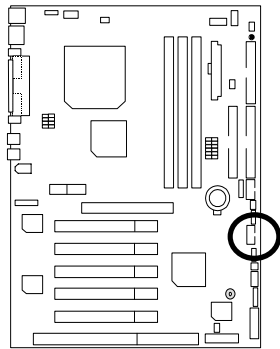

| Pin No. | Definition |
|---------|------------|
| 1,10    | +5V        |
| 2,9     | GND        |
| 3       | USB D2-    |
| 4,7     | NC         |
| 5       | USB D2+    |
| 6       | USB D3+    |
| 8       | USB D3-    |

IR Connector

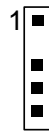
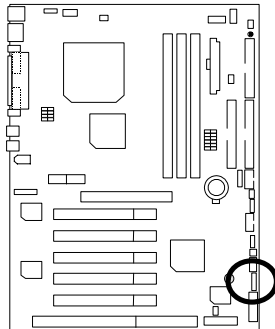

| PIN No. | Definition     |
|---------|----------------|
| 1       | VCC(+5V)       |
| 2       | NC             |
| 3       | IR data input  |
| 4       | GND            |
| 5       | IR data output |

Floppy Port

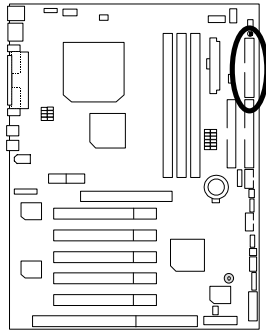

RED LINE



IDE1 (Primary), IDE2(Secondary) Port

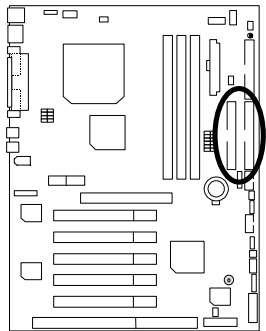

RED LINE

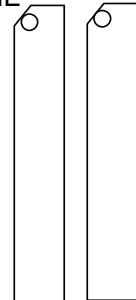

IDE 1 IDE 2

### J3: Ring Power On (Internal Modem Card Wake Up)

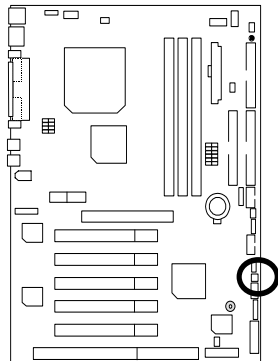

| Pin No. | Definition |
|---------|------------|
| 1       | Signal     |
| 2       | GND        |

### J1: Wake On LAN

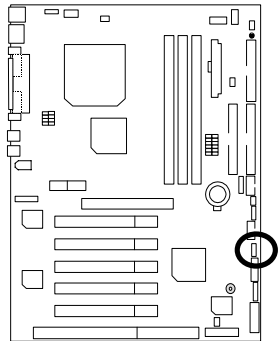

| Pin No. | Definition |
|---------|------------|
| 1       | +5V SB     |
| 2       | GND        |
| 3       | Signal     |

## JP5: STR LED Connector &amp; LED1: DIMM LED

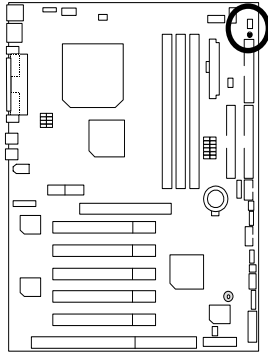

STR LED Connector External



DIMM LED

## Front USB Port (Optional)

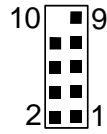
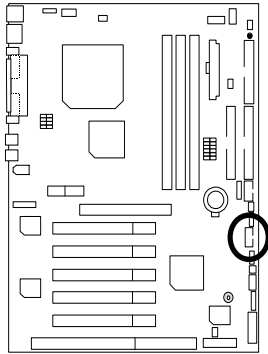

| Pin No.  | Definition |
|----------|------------|
| 1,4,5,10 | NC         |
| 2        | +5V        |
| 3,7,9    | GND        |
| 6        | USBP2+     |
| 8        | USBP2-     |

J11: SM BUS

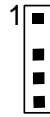
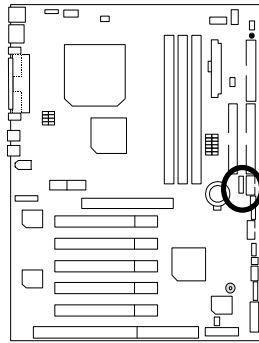

| Pin No. | Definition |
|---------|------------|
| 1       | SMB CLK    |
| 2       | NC         |
| 3       | GND        |
| 4       | SMB DATA   |
| 5       | +5V        |

CN4 : IEEE 1394 Connect (Optional)

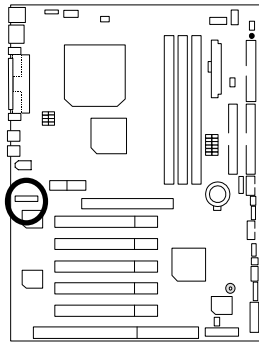

1

| Pin No. | Definition |
|---------|------------|
| 1       | VP         |
| 2       | VG         |
| 3       | TPB-       |
| 4       | TPB+       |
| 5       | TPA-       |
| 6       | TPA+       |



## Panel And Jumper Definition

J2: For 2X11 Pins Jumper

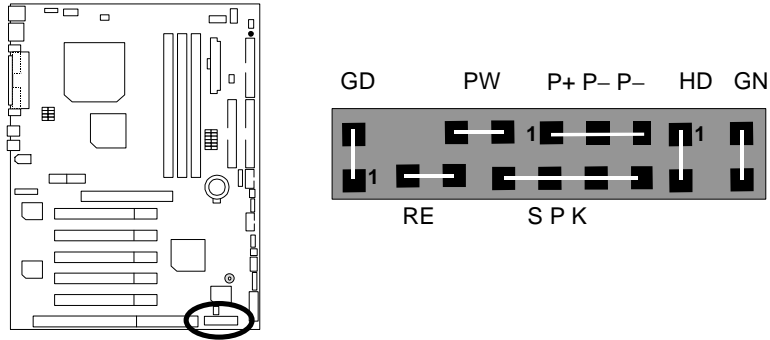

|                               |   |
|-------------------------------|---|
| GN (Green Switch)             | Open: Normal Operation<br>Close: Entering Green Mode                  |
| GD (Green LED)                | Pin 1: LED anode(+)<br>Pin 2: LED cathode(-)                          |
| HD (IDE Hard Disk Active LED) | Pin 1: LED anode(+)<br>Pin 2: LED cathode(-)                          |
| SPK (Speaker Connector)       | Pin 1: VCC(+)<br>Pin 2- Pin 3: NC<br>Pin 4: Data(-)                   |
| RE (Reset Switch)             | Open: Normal Operation<br>Close: Reset Hardware System                |
| P+P-P-(Power LED)             | Pin 1: LED anode(+)<br>Pin 2: LED cathode(-)<br>Pin 3: LED cathode(-) |
| PW (Soft Power Connector)     | Open: Normal Operation<br>Close: Power On/Off                         |

JP1: Clear CMOS Function (Optional)

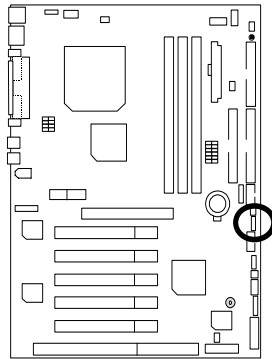

| Pin No.   | Definition       |
|-----------|------------------|
| 1-2 close | Normal (Default) |
| 2-3 close | Clear CMOS       |

JP11: STR Enable

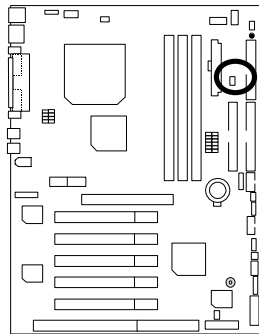

| Pin No. | Definition             |
|---------|------------------------|
| Open    | STR Disabled (Default) |
| Close   | STR Enabled            |

JP19: Cyrix CPU Turbo Function (Optional)

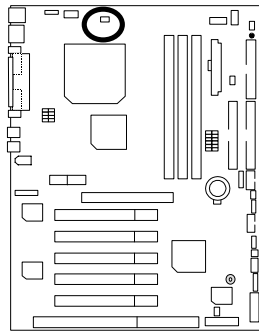

| Pin No. | Definition   |
|---------|--------------|
| Open    | Normal       |
| Close   | Cyrix 133MHz |

JP9: USB Device Wake up Selection

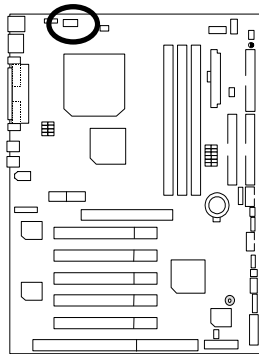

| Pin No.   | Definition                 |
|-----------|----------------------------|
| 1-2 close | Normal (Default)           |
| 2-3 close | Enabled USB Device Wake up |

(If you want to use "USB KB Wakeup from S3~S5" function, you have to set the BIOS setting "USB KB Wakeup from S3~S5" enabled, and the jumper "JP9" enabled).  
 \*(Power on the computer and as soon as memory counting starts, press <Del>. You will enter BIOS Setup. Select the item "POWER MANAGEMENT SETUP", then select "USB KB Wakeup from S3~S5: Enabled". Remember to save the setting by pressing "ESC" and choose the "SAVE & EXIT SETUP" option.)

### JP23: Case Open

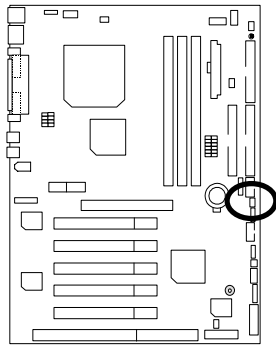

| Pin No. | Definition |
|---------|------------|
| 1       | Signal     |
| 2       | GND        |

### JP22: BIOS Flash ROM Write Protect

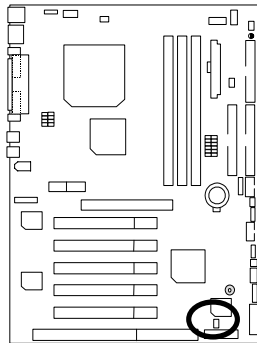

| Pin No. | Definition                   |
|---------|------------------------------|
| Close   | BIOS Write Disabled          |
| Open    | BIOS Write Enabled (Default) |

● Please set Jumper JP22 to "Open" to enabled BIOS write function when you update new BIOS or new device.

**JP30: Over Voltage CPU Speed Up (Magic Booster) (Optional)**

(When JP30 set "7-8 Close", CPU Voltage is rising 10%)

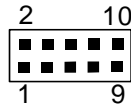
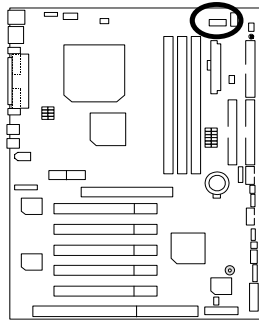

| Pin No.    | Definition |
|------------|------------|
| 1-2 close  | 40%        |
| 3-4 close  | 30%        |
| 5-6 close  | 20%        |
| 7-8 close  | 10%        |
| 9-10 close | Normal     |

**J12: Front Panel Jumper (Optional)**

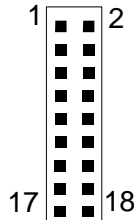
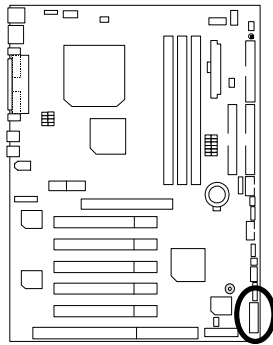

| Pin No.       | Definition  |
|---------------|-------------|
| 1             | HD LED+     |
| 2             | GN LED+     |
| 3             | HD LED-     |
| 4             | PWR LED+    |
| 7             | RESET SW    |
| 6             | Soft ON/OFF |
| 10            | Green SW    |
| 9             | +5V         |
| 11            | IR RX       |
| 8,5,13,<br>12 | GND         |
| 15            | IRTX        |
| 17,14,18      | NC          |
| 16            | +5V         |

## BAT1: Battery

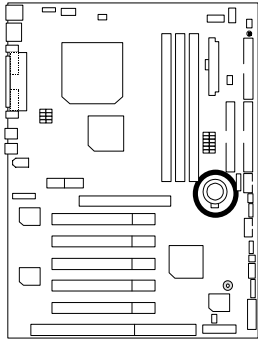

### CAUTION

- ⓘ Danger of explosion if battery is incorrectly replaced.
- ⓘ Replace only with the same or equivalent type recommended by the manufacturer.
- ⓘ Dispose of used batteries according to the manufacturer's instructions.

## Performance List

The following performance data list is the testing results of some popular benchmark testing programs.

These data are just referred by users, and there is no responsibility for different testing data values gotten by users. (The different Hardware & Software configuration will result in different benchmark testing results.)

- CPU Intel Pentium® !!! Socket 370 Processor
- DRAM (128 x 1) MB SDRAM (Kingmax KSV884T4A1A-07)
- CACHE SIZE 256 KB included in CPU (Pentium® !!!)  
128 KB included in CPU (Pentium® !!!)
- DISPLAY GA-GF2000
- STORAGE Onboard IDE (Quantum AS30000AT 30GB)
- O.S. Windows 2000 +SP1
- DRIVER Display Driver at 1024 x 768 x 64K x 75Hz  
TUCD ver1.7 for Third Party chipset M.B

| Processor                     | Intel Pentium® !!! Socket 370 |                  |
|-------------------------------|-------------------------------|------------------|
|                               | 1000MHz (133x7.5)             | 850MHz (100x8.5) |
| <b>Winbench99 (ver. 1.2g)</b> |                               |                  |
| Business Disk                 | 7600                          | 7160             |
| Hi-End Disk                   | 16500                         | 15200            |
| Business Graphics             | 402                           | 273              |
| Hi-End Graphics               | 895                           | 669              |
| <b>Winstone2001</b>           |                               |                  |
| Business Winstone             | 38.8                          | 31.6             |
| Content Creation Winstone     | 38.5                          | 33.9             |

● If you wish to maximize the performance of your system, please refer to the detail on P.50

# Block Diagram

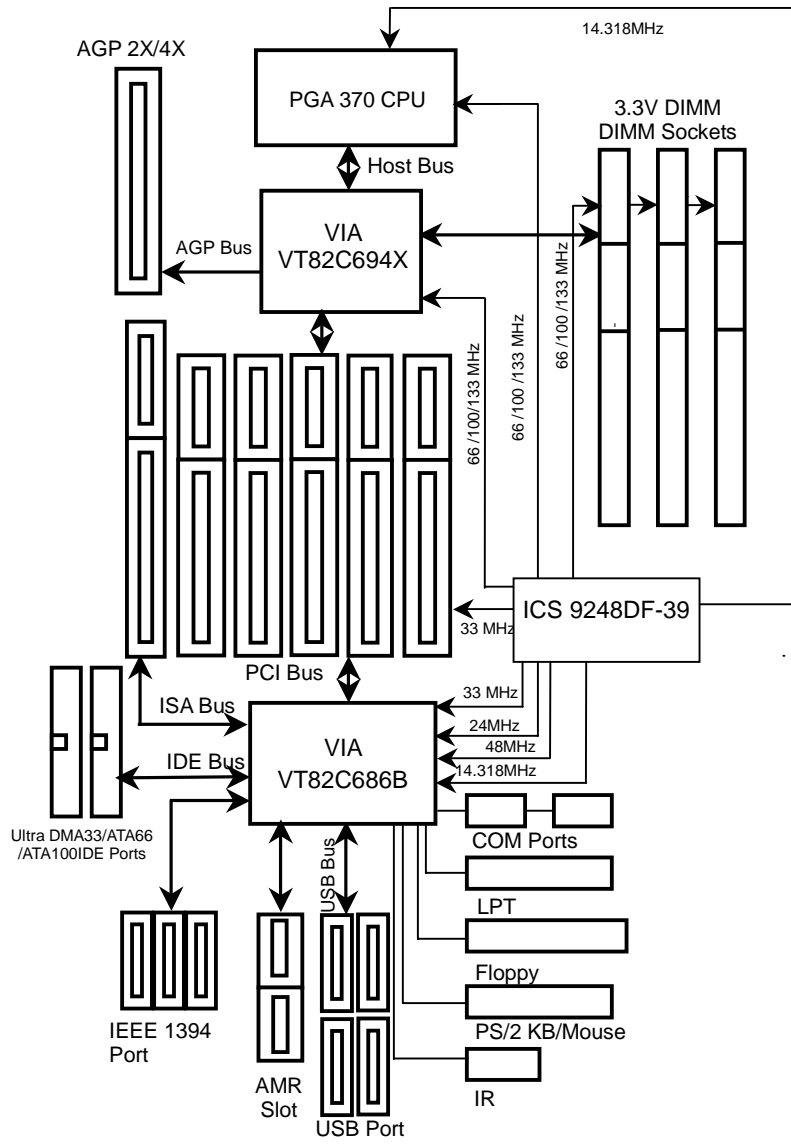



---

## Suspend To RAM Installation

### A.1 Introduce STR function:

Suspend-to-RAM (STR) is a Windows 98 ACPI sleep mode function. When recovering from STR (S3) sleep mode, the system is able, in just a few seconds, to retrieve the last "state" of the system before it went to sleep and recover to that state. The "state" is stored in memory (RAM) before the system goes to sleep. During STR sleep mode, your system uses only enough energy to maintain critical information and system functions, primarily the system state and the ability to recognize various "wake up" triggers or signals, respectively.

### A.2 STR function Installation

Please use the following steps to complete the STR function installation.

#### Step-By-Step Setup

##### Step 1:

To utilize the STR function, the system must be in Windows 98 ACPI mode.

Putting Windows 98 into ACPI mode is fairly easy.

#### Setup with Windows 98 CD:

- A. Insert the Windows 98 CD into your CD-ROM drive, select Start, and then Run.
- B. Type (without quotes) "**D:\setup**" in the window provided. Hit the enter key or click OK.
- C. After setup completes, remove the CD, and reboot your system

(This manual assumes that your CD-ROM device drive letter is D:).

**Step 2:**

(If you want to use STR Function, please set jumper JP11 Closed.)

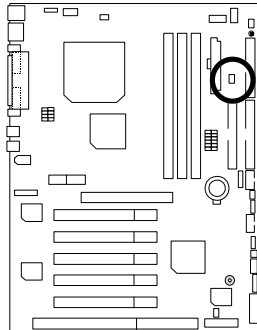

| Pin No. | Definition             |
|---------|------------------------|
| Open    | STR Disabled (Default) |
| Close   | STR Enabled            |

**Step 3:**

Power on the computer and as soon as memory counting starts, press <Del>. You will enter BIOS Setup. Select the item **"POWER MANAGEMENT SETUP"**, then select **"ACPI Sleep Type: S3 / STR"**. Remember to save the settings by pressing "ESC" and choose the **"SAVE & EXIT SETUP"** option.

Congratulation! You have completed the installation and now can use the STR function.

### A.3 How to put your system into STR mode?

There are two ways to accomplish this:

1. Choose the "Stand by" item in the "Shut Down Windows" area.
  - A. Press the "Start" button and then select "Shut Down"



- B. Choose the "Stand by" item and press "OK"

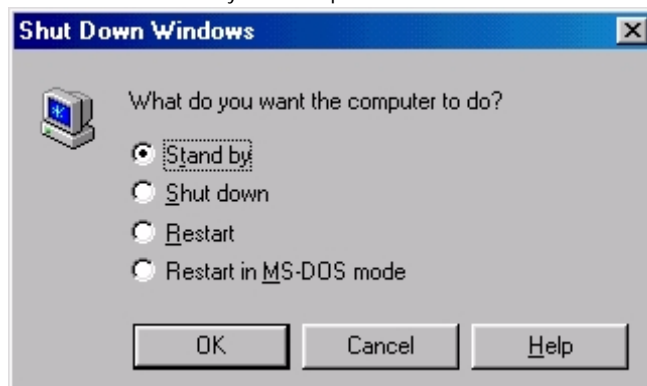

2. Define the system "power on" button to initiate STR sleep mode:
  - A. Double click "My Computer" and then "Control Panel"

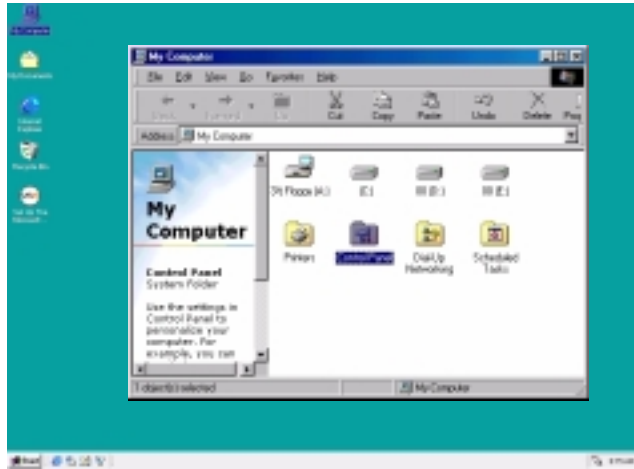

- B. Double click the " Power Management" item.

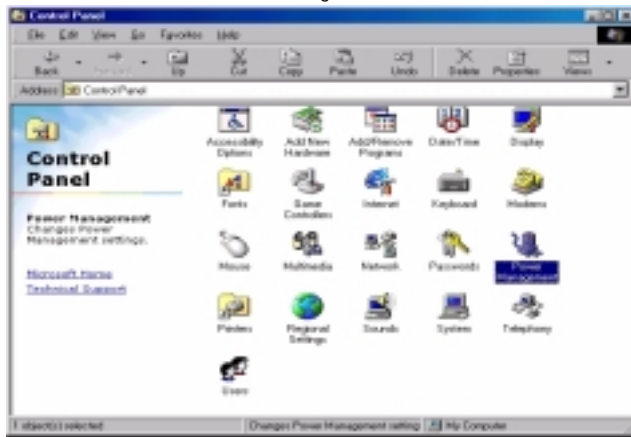

C. Select the "Advanced" tab and "Standby" mode in Power Buttons.

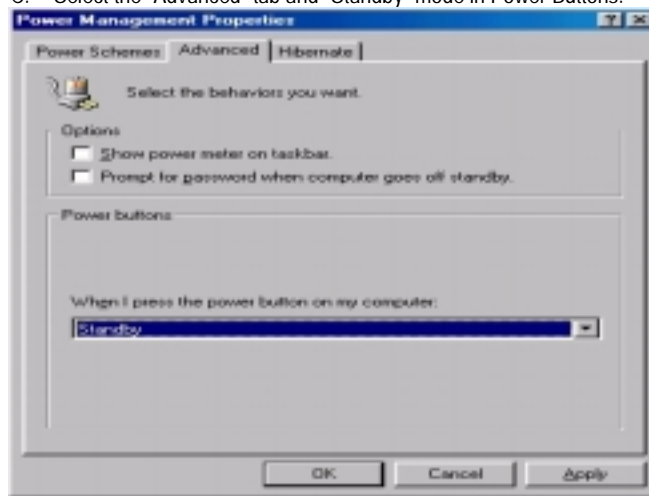

D. Restart your computer to complete setup.

Now when you want to enter STR sleep mode, just momentarily press the "Power on" button..

#### A.4 How to recover from the STR sleep mode?

There are five ways to "wake up" the system:

1. Press the "Power On" button.
2. Use the "Resume by Alarm" function.
3. Use the "Modem Ring On" function.
4. Use the "Wake On LAN" function.
5. Use the "USB Device Wake up" function.

**A.5 Notices:**

1. In order for STR to function properly, several hardware and software requirements must be satisfied:
  - A. Your ATX power supply must comply with the ATX 2.01 specification (provide more than 720 mA 5V Stand-By current).
  - B. Your SDRAM must be PC-100 compliant.
2. Jumper JP5 is provided to connect to the STR LED in your system chassis. [Your chassis may not provide this feature.] The STR LED will be illuminated when your system is in STR sleep mode.

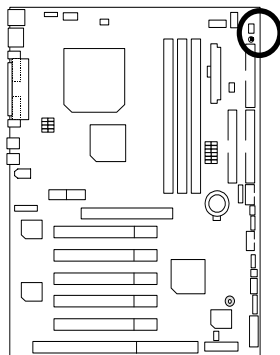

STR LED Connector External



DIMM LED

## Memory Installation

The motherboard has 3 dual inline memory module (DIMM) sockets. The BIOS will automatically detects memory type and size. To install the memory module, just push it vertically into the DIMM Slot .The DIMM module can only fit in one direction due to the two notch. Memory size can vary between sockets.

Install memory in any combination table:

| DIMM  | 168-pin SDRAM DIMM Modules                |         |
|-------|---|---------|
| DIMM1 | Supports 16 / 32 / 64 / 128 / 256 / 512MB | X 1 pcs |
| DIMM2 | Supports 16 / 32 / 64 / 128 / 256 / 512MB | X 1 pcs |
| DIMM3 | Supports 16 / 32 / 64 / 128 / 256 / 512MB | X 1 pcs |

|  Page Index for BIOS Setup | Page |
|---|------|
| The Main Menu   | P.43 |
| Standard CMOS Setup   | P.45 |
| BIOS Features Setup   | P.48 |
| Chipset Features Setup  | P.50 |
| Power Management Setup  | P.53 |
| PNP/ PCI Configuration  | P.56 |
| Load BIOS Defaults  | P.58 |
| Load Setup Defaults   | P.59 |
| Integrated Peripherals  | P.60 |
| Hardware Monitor Setup  | P.63 |
| Supervisor Password / User Password   | P.65 |
| IDE HDD Auto Detection  | P.66 |
| Save to CMOS and Exit   | P.67 |
| Exit Without Saving   | P.68 |



## BIOS Setup

BIOS Setup is an overview of the BIOS Setup Program. The program that allows users to modify the basic system configuration. This type of information is stored in battery-backed CMOS RAM so that it retains the Setup information when the power is turned off.

### ENTERING SETUP

Power ON the computer and press <Del> immediately will allow you to enter Setup. If the message disappears before you respond and you still wish to enter Setup, restart the system to try again by turning it OFF then ON or pressing the "RESET" bottom on the system case. You may also restart by simultaneously press <Ctrl> – <Alt>– <Del> keys.

### CONTROL KEYS

|          |  |
|----------|--|
| <↑>      | Move to previous item  |
| <↓>      | Move to next item  |
| <←>      | Move to the item in the left hand  |
| <→>      | Move to the item in the right hand   |
| <Esc>    | Main Menu - Quit and not save changes into CMOS<br>Status Page Setup Menu and Option Page Setup Menu - Exit current page and return to Main Menu |
| <+/PgUp> | Increase the numeric value or make changes   |
| <-/PgDn> | Decrease the numeric value or make changes   |
| <F1>     | General help, only for Status Page Setup Menu and Option Page Setup Menu   |
| <F2>     | Reserved   |
| <F3>     | Reserved   |
| <F4>     | Reserved   |
| <F5>     | Restore the previous CMOS value from CMOS, only for Option Page Setup Menu   |
| <F6>     | Load the default CMOS value from BIOS default table, only for Option Page Setup Menu   |
| <F7>     | Load the Setup Defaults.   |
| <F8>     | Reserved   |
| <F9>     | Reserved   |
| <F10>    | Save all the CMOS changes, only for Main Menu  |

## GETTING HELP

### Main Menu

The on-line description of the highlighted setup function is displayed at the bottom of the screen.

### Status Page Setup Menu / Option Page Setup Menu

Press F1 to pop up a small help window that describes the appropriate keys to use and the possible selections for the highlighted item. To exit the Help Window press <Esc>.

## The Main Menu

Once you enter AMI BIOS CMOS Setup Utility, the Main Menu (Figure 1) will appear on the screen. The Main Menu allows you to select from nine setup functions and two exit choices. Use arrow keys to select among the items and press <Enter> to accept or enter the sub-menu.

| AMIBIOS SIMPLE SETUP UTILITY-VERSION 1.23<br>( C ) 1999 American Megatrends, Inc. All Rights Reserved   |                        |
|---|------------------------|
| STANDARD CMOS SETUP   | INTEGRATED PERIPHERALS |
| BIOS FEATURES SETUP   | HARDWARE MONITOR SETUP |
| CHIPSET FEATURES SETUP  | SUPERVISOR PASSWORD    |
| POWER MANAGEMENT SETUP  | USER PASSWORD          |
| PNP/PCI CONFIGURATION   | IDE HDD AUTO DETECTION |
| LOAD BIOS DEFAULTS  | SAVE & EXIT SETUP      |
| LOAD SETUP DEFAULTS   | EXIT WITHOUT SAVING    |
| ESC : Quit    ↑↓←→ : Select Item    (Shift) F2 : Change Color    F5 : Old Values<br>F6 : Load BIOS Defaults    F7 : Load Setup Defaults    F10: Save & Exit |                        |
| Time, Date, Hard Disk Type, ...   |                        |

Figure 1: Main Menu

- **Standard CMOS Setup**  
This setup page includes all the items in standard compatible BIOS.
- **BIOS Features Setup**  
This setup page includes all the items of AMI special enhanced features.

- **Chipset Features Setup**

This setup page includes all the items of chipset special features.
- **Power Management Setup**

This setup page includes all the items of Green function features.
- **PnP/PCI Configurations**

This setup page includes all the configurations of PCI & PnP ISA resources.
- **Load BIOS Defaults**

Bios Defaults indicates the value of the system parameter which the system would be in the safe configuration.
- **Load Setup Defaults**

Setup Defaults indicates the value of the system parameter which the system would be in the most appropriate configuration.
- **Integrated Peripherals**

This setup page includes all onboard peripherals.
- **Hardware Monitor Setup**

This setup page is auto detect fan and temperature status.
- **Supervisor password**

Change, set, or disable password. It allows you to limit access to the system and Setup, or just to Setup.
- **User password**

Change, set, or disable password. It allows you to limit access to the system.
- **IDE HDD auto detection**

Automatically configure hard disk parameters.
- **Save & Exit Setup**

Save CMOS value settings to CMOS and exit setup.
- **Exit Without Saving**

Abandon all CMOS value changes and exit setup.

## Standard CMOS Setup

The items in Standard CMOS Features Menu (Figure 2) are divided into 9 categories. Each category includes no, one or more than one setup items. Use the arrows to highlight the item and then use the <PgUp> or <PgDn> keys to select the value you want in each item.

| AMIBIOS SETUP – STANDARD CMOS SETUP<br>( C ) 1999 American Megatrends, Inc. All Rights Reserved  |                       |      |      |         |       |         |       |        |      |            |        |  |  |  |  |  |  |           |        |  |  |  |  |  |  |            |        |  |  |  |  |  |  |           |        |  |  |  |  |  |  |
|--|-----------------------|------|------|---------|-------|---------|-------|--------|------|------------|--------|--|--|--|--|--|--|-----------|--------|--|--|--|--|--|--|------------|--------|--|--|--|--|--|--|-----------|--------|--|--|--|--|--|--|
| Date (mm/dd/yyyy) : Thu Feb 24, 2000<br>Time (hh/mm/ss) : 10:36:24   |                       |      |      |         |       |         |       |        |      |            |        |  |  |  |  |  |  |           |        |  |  |  |  |  |  |            |        |  |  |  |  |  |  |           |        |  |  |  |  |  |  |
| <table border="1"> <thead> <tr> <th>TYPE</th> <th>SIZE</th> <th>CYLS</th> <th>HEAD</th> <th>PRECOMP</th> <th>LANDZ</th> <th>SECTOR</th> <th>MODE</th> </tr> </thead> <tbody> <tr> <td>Pri Master</td> <td>: Auto</td> <td></td> <td></td> <td></td> <td></td> <td></td> <td></td> </tr> <tr> <td>Pri Slave</td> <td>: Auto</td> <td></td> <td></td> <td></td> <td></td> <td></td> <td></td> </tr> <tr> <td>Sec Master</td> <td>: Auto</td> <td></td> <td></td> <td></td> <td></td> <td></td> <td></td> </tr> <tr> <td>Sec Slave</td> <td>: Auto</td> <td></td> <td></td> <td></td> <td></td> <td></td> <td></td> </tr> </tbody> </table> |                       | TYPE | SIZE | CYLS    | HEAD  | PRECOMP | LANDZ | SECTOR | MODE | Pri Master | : Auto |  |  |  |  |  |  | Pri Slave | : Auto |  |  |  |  |  |  | Sec Master | : Auto |  |  |  |  |  |  | Sec Slave | : Auto |  |  |  |  |  |  |
| TYPE   | SIZE                  | CYLS | HEAD | PRECOMP | LANDZ | SECTOR  | MODE  |        |      |            |        |  |  |  |  |  |  |           |        |  |  |  |  |  |  |            |        |  |  |  |  |  |  |           |        |  |  |  |  |  |  |
| Pri Master   | : Auto                |      |      |         |       |         |       |        |      |            |        |  |  |  |  |  |  |           |        |  |  |  |  |  |  |            |        |  |  |  |  |  |  |           |        |  |  |  |  |  |  |
| Pri Slave  | : Auto                |      |      |         |       |         |       |        |      |            |        |  |  |  |  |  |  |           |        |  |  |  |  |  |  |            |        |  |  |  |  |  |  |           |        |  |  |  |  |  |  |
| Sec Master   | : Auto                |      |      |         |       |         |       |        |      |            |        |  |  |  |  |  |  |           |        |  |  |  |  |  |  |            |        |  |  |  |  |  |  |           |        |  |  |  |  |  |  |
| Sec Slave  | : Auto                |      |      |         |       |         |       |        |      |            |        |  |  |  |  |  |  |           |        |  |  |  |  |  |  |            |        |  |  |  |  |  |  |           |        |  |  |  |  |  |  |
| Floppy Drive A: 1.44 MB 3 ½  | Base Memory : 640 Kb  |      |      |         |       |         |       |        |      |            |        |  |  |  |  |  |  |           |        |  |  |  |  |  |  |            |        |  |  |  |  |  |  |           |        |  |  |  |  |  |  |
| Floppy Drive B: Not Installed  | Other Memory: 384 Kb  |      |      |         |       |         |       |        |      |            |        |  |  |  |  |  |  |           |        |  |  |  |  |  |  |            |        |  |  |  |  |  |  |           |        |  |  |  |  |  |  |
| Boot Sector Virus Protection : Disabled  | Extended Memory: 30Mb |      |      |         |       |         |       |        |      |            |        |  |  |  |  |  |  |           |        |  |  |  |  |  |  |            |        |  |  |  |  |  |  |           |        |  |  |  |  |  |  |
|  | Total Memory: 31Mb    |      |      |         |       |         |       |        |      |            |        |  |  |  |  |  |  |           |        |  |  |  |  |  |  |            |        |  |  |  |  |  |  |           |        |  |  |  |  |  |  |
| Month: Jan – Dec   | ESC : Exit            |      |      |         |       |         |       |        |      |            |        |  |  |  |  |  |  |           |        |  |  |  |  |  |  |            |        |  |  |  |  |  |  |           |        |  |  |  |  |  |  |
| Day: 01 – 31   | ↑↓ : Select Item      |      |      |         |       |         |       |        |      |            |        |  |  |  |  |  |  |           |        |  |  |  |  |  |  |            |        |  |  |  |  |  |  |           |        |  |  |  |  |  |  |
| Year: 1990– 2099   | PU/PD/+/- : Modify    |      |      |         |       |         |       |        |      |            |        |  |  |  |  |  |  |           |        |  |  |  |  |  |  |            |        |  |  |  |  |  |  |           |        |  |  |  |  |  |  |
|  | (Shift)F2 : Color     |      |      |         |       |         |       |        |      |            |        |  |  |  |  |  |  |           |        |  |  |  |  |  |  |            |        |  |  |  |  |  |  |           |        |  |  |  |  |  |  |

Figure 2: Standard CMOS Setup

- **Date**

The date format is <Week>, <Month>, <Day>, <Year>.

|       |   |
|-------|---|
| Week  | The week, from Sun to Sat, determined by the BIOS and is display-only |
| Month | The month, Jan. Through Dec.  |
| Day   | The day, from 1 to 31 (or the maximum allowed in the month)           |
| Year  | The year, from 1990 through 2099                                      |

- **Time**

The times format in <hour> <minute> <second>. The time is calculated base on the 24-hour military-time clock. For example, 1 p.m. is 13:00:00.

- **IDE Primary Master, Slave / Secondary Master, Slave**

The category identifies the types of hard disk from drive C to F that has been installed in the computer. There are two types: auto type, and user definable type. User type is user-definable; Auto type which will automatically detect HDD type.

Note that the specifications of your drive must match with the drive table. The hard disk will not work properly if you enter improper information for this category.

If you select User Type, related information will be asked to enter to the following items. Enter the information directly from the keyboard and press <Enter>. Such information should be provided in the documentation form your hard disk vendor or the system manufacturer.

|          |                     |
|----------|---------------------|
| CYLS.    | Number of cylinders |
| HEADS    | number of heads     |
| PRECOMP  | write precomp       |
| LANDZONE | Landing zone        |
| SECTORS  | number of sectors   |

If a hard disk has not been installed select NONE and press <Enter>.

- **Drive A type / Drive B type**

The category identifies the types of floppy disk drive A or drive B that has been installed in the computer.

|                |   |
|----------------|---|
| None           | No floppy drive installed   |
| 360K, 5.25 in. | 5.25 inch PC-type standard drive; 360K byte capacity.                                       |
| 1.2M, 5.25 in. | 5.25 inch AT-type high-density drive; 1.2M byte capacity (3.5 inch when 3 Mode is Enabled). |
| 720K, 3.5 in.  | 3.5 inch double-sided drive; 720K byte capacity   |
| 1.44M, 3.5 in. | 3.5 inch double-sided drive; 1.44M byte capacity.   |
| 2.88M, 3.5 in. | 3.5 inch double-sided drive; 2.88M byte capacity.   |

- **Boot Sector Virus Protection**

If it is set to enable, the category will flash on the screen when there is any attempt to write to the boot sector or partition table of the hard disk drive. The system will halt and the following error message will appear in the mean time. You can run anti-virus program to locate the problem.

|          |   |
|----------|---|
| Enabled  | Activate automatically when the system boots up causing a warning message to appear when anything attempts to access the boot sector or hard disk partition table |
| Disabled | No warning message to appear when anything attempts to access the boot sector or hard disk partition table. <b>(Default Value)</b>                                |

- **Memory**

The category is display-only which is determined by POST (Power On Self Test) of the BIOS.

**Base Memory**

The POST of the BIOS will determine the amount of base (or conventional) memory installed in the system.

The value of the base memory is typically 512 K for systems with 512 K memory installed on the motherboard, or 640 K for systems with 640 K or more memory installed on the motherboard.

**Extended Memory**

The BIOS determines how much extended memory is present during the POST.

This is the amount of memory located above 1 MB in the CPU's memory address map.

**Other Memory**

This refers to the memory located in the 640 K to 1024 K address space. This is memory that can be used for different applications.

DOS uses this area to load device drivers to keep as much base memory free for application programs. Most use for this area is Shadow RAM

BIOS Features Setup

| AMIBIOS SETUP – BIOS FEATURES CMOS SETUP<br>(C) 1999 American Megatrends, Inc. All Rights Reserved   |           |
|--|-----------|
| 1st Boot Device  | :Floppy   |
| 2nd Boot Device  | :IDE-0    |
| 3rd Boot Device  | :CDROM    |
| S.M.A.R.T for Hard Disks   | :Disabled |
| BootUp Num-Lock  | :On       |
| Floppy Drive Seek  | :Disabled |
| Password Check   | :Setup    |
| Processor Serial Number  | :Disabled |
| ESC : Quit                      ↑↓←→: Select Item<br>F1 : Help                        PU/PD/+/- : Modify<br>F5 : Old Values                (Shift)F2 :Color<br>F6 : Load BIOS Defaults<br>F7 : Load Setup Defaults |           |

Figure 3: BIOS Features Setup

● 1st / 2nd / 3rd Boot Device

|              |                              |
|--------------|------------------------------|
| Floppy       | Boot Device by Floppy.       |
| LS / ZIP A:  | Boot Device by LS / ZIP A:.  |
| CDROM        | Boot Device by CDROM.        |
| SCSI         | Boot Device by SCSI.         |
| NETWORK      | Boot Device by NETWORK.      |
| IDE-0-IDE-3  | Boot Device by IDE-0-IDE-3.  |
| Disabled     | Boot Device by Disabled.     |
| ATAPI ZIP C: | Boot Device by ATAPI ZIP C:. |

● S.M.A.R.T. for Hard Disks

|         |   |
|---------|---|
| Enable  | Enable S.M.A.R.T. Hard for Disks.                         |
| Disable | Disable S.M.A.R.T. Hard for Disks. <b>(Default Value)</b> |

- **Boot Up Num-Lock**

|     |   |
|-----|---|
| On  | Keypad is number keys. <b>(Default Value)</b> |
| Off | Keypad is arrow keys.                         |

- **Floppy Drive Seek**

During POST, BIOS will determine if the floppy disk drive installed is 40 or 80 tracks. 360 type is 40 tracks while 720 , 1.2 and 1.44 are all 80 tracks.

|          |   |
|----------|---|
| Enabled  | BIOS searches for floppy disk drive to determine if it is 40 or 80 tracks. Note that BIOS can not tell from 720, 1.2 or 1.44 drive type as they are all 80 tracks.            |
| Disabled | BIOS will not search for the type of floppy disk drive by track number. Note that there will not be any warning message if the drive installed is 360. <b>(Default Value)</b> |

- **Password Check**

|        |   |
|--------|---|
| Setup  | Set Password Check to Setup. <b>(Default Value)</b> |
| Always | Set Password Check to Always.                       |

- **Processor Serial Number** (Only support Pentium® !!!Processor)

|          |  |
|----------|--|
| Disabled | Disabled CPU Serial Number. <b>(Default Value)</b> |
| Enabled  | Enabled CPU Serial Number.                         |



Chipset Features Setup

| AMIBIOS SETUP –CHIPSET FEATURE CMOS SETUP<br>( C ) 1999 American Megatrends, Inc. All Rights Reserved   |                |
|---|----------------|
| *** DRAM Timing ***   |                |
| Top Performance   | :Disabled      |
| SDRAM Timing by SPD   | :Disabled      |
| SDRAM CAS# Latency  | :3             |
| DRAM Frequency  | :Auto          |
| C2P Concurrency & Master  | :Enabled       |
| DRAM Integrity Mode   | :Disabled      |
| AGP Mode  | :4X            |
| AGP Comp. Driving   | :Auto          |
| Manual AGP Comp. Driving  | :CB            |
| AGP Aperture Size   | :64MB          |
| ClkGen Spread Spectrum  | :Center± 0.25% |
| South Bridge Subsystem ID   | :Disabled      |
| USB Controller  | :All USB Port  |
| USB Legacy Support  | :Disabled      |
| ESC : Quit                    ↑↓←→ : Select Item<br>F1 : Help                    PU/PD/+/- : Modify<br>F5 : Old Values (Shift)F2 : Color<br>F6 : Load BIOS Defaults<br>F7 : Load Setup Defaults |                |

Figure 4: Chipset Features Setup

● **Top Performance**

If you wish to maximize the performance of your system, set "Top Performance" as "Enabled".

|          |  |
|----------|--|
| Disabled | Disabled Top Performance. <b>(Default Value)</b> |
| Enabled  | Enabled Top Performance.                         |

● **SDRAM Timing by SPD**

|          |   |
|----------|---|
| Disabled | SDRAM Timing by SPD Function Disabled. <b>(Default Value)</b> |
| Enabled  | SDRAM Timing by SPD Function Enabled.                         |

● **SDRAM CAS# Latency**

|   |  |
|---|--|
| 3 | For Slower SDRAM DIMM module. <b>(Default Value)</b> |
| 2 | For Fastest SDRAM DIMM module.                       |

● **DRAM Frequency**

|        |  |
|--------|--|
| Auto   | Set DRAM Frequency is Auto. <b>(Default Value)</b> |
| 100MHz | Set DRAM Frequency is 100MHz.                      |
| 66MHz  | Set DRAM Frequency is 66MHz.                       |
| 133MHz | Set DRAM Frequency is 133MHz.                      |

- **C2P Concurrency & Master**

|          |  |
|----------|--|
| Enabled  | Enabled C2P Concurrency & Master. <b>(Default Value)</b> |
| Disabled | Disabled C2P Concurrency & Master.                       |

- **DRAM Integrity Mode**

|          |  |
|----------|--|
| ECC      | For 72 bit ECC type DIMM Modle.        |
| Disabled | Normal Setting. <b>(Default Value)</b> |

- **AGP Mode**

|    |  |
|----|--|
| 4X | Set AGP Mode is 4X. <b>(Default Value)</b> |
| 1X | Set AGP Mode is 1X.                        |
| 2X | Set AGP Mode is 2X.                        |

- **AGP Comp. Driving**

|        |   |
|--------|---|
| Auto   | Set AGP Comp. Driving is Auto. <b>(Default Value)</b> |
| Manual | Set AGP Comp. Driving is Manual.                      |

If AGP Comp. Driving is Manual.

|                            |       |
|----------------------------|-------|
| Manual AGP Comp. Driving : | 00-FF |
|----------------------------|-------|

- **AGP Aperture Size**

|       |  |
|-------|--|
| 4MB   | Set AGP Aperture Size to 4MB.                          |
| 8MB   | Set AGP Aperture Size to 8 MB.                         |
| 16MB  | Set AGP Aperture Size to 16 MB.                        |
| 32MB  | Set AGP Aperture Size to 32 MB.                        |
| 64MB  | Set AGP Aperture Size to 64 MB. <b>(Default Value)</b> |
| 128MB | Set AGP Aperture Size to 128 MB.                       |
| 256MB | Set AGP Aperture Size to 256 MB.                       |

- **ClkGen Spread Spectrum**

|               |   |
|---------------|---|
| Disabled      | Spread Spectrum Disabled.   |
| Center± 0.25% | Set Spread Spectrum 0. 25%(Center Spread). <b>(Default Value)</b> |
| Center± 0.5%  | Set Spread Spectrum 0. 5%(Center Spread).                         |

● **South Bridge Subsystem ID**

|          |  |
|----------|--|
| Disabled | Disable it if you have to install VIA 4 in 1 SP4.22 or before.<br><b>(Default Value)</b> |
| Enabled  | Enable south bridge subsystem ID function.   |

● **USB Controller**

|              |   |
|--------------|---|
| USB Port 0&1 | USB Controller for USB Port 0&1.                        |
| USB Port 2&3 | USB Controller for USB Port 2&3.                        |
| All USB Port | USB Controller for All USB Port. <b>(Default Value)</b> |
| Disabled     | USB Controller Function Disabled.                       |

● **USB Legacy Support**

|            |  |
|------------|--|
| Keyboard   | Set USB Legacy Support Keyboard.                             |
| Keyb+Mouse | Set USB Legacy Support Keyboard +Mouse.                      |
| Disabled   | Disabled USB Legacy Support Function. <b>(Default Value)</b> |

## Power Management Setup

| AMBIOS SETUP –POWER MANAGEMENT SETUP<br>( C ) 1999 American Megatrends, Inc. All Rights Reserved |              |                                  |                    |
|--|--------------|----------------------------------|--------------------|
| ACPI Sleep type  | :S1/POS      | PME Event Wake up                | :Enabled           |
| USB KB Wakeup From S3-S5   | :Disabled    | RTC Alarm Power On               | :Disabled          |
| Video Power Down Mode  | :Stand By    | RTC Alarm Date                   | :15                |
| Hard Disk Power Down Mode  | :Stand By    | RTC Alarm Hour                   | :12                |
| Suspend Time Out(Minute)   | :Disabled    | RTC Alarm Minute                 | :30                |
| Display Activity   | :Ignore      | RTC Alarm Second                 | :30                |
| IRQ3   | :Monitor     |                                  |                    |
| IRQ 4  | :Monitor     |                                  |                    |
| IRQ 5  | :Ignore      |                                  |                    |
| IRQ 7  | :Monitor     |                                  |                    |
| IRQ 9  | :Ignore      |                                  |                    |
| IRQ 10   | :Ignore      |                                  |                    |
| IRQ 11   | :Ignore      |                                  |                    |
| IRQ 13   | :Ignore      |                                  |                    |
| IRQ 14   | :Monitor     |                                  |                    |
| IRQ 15   | :Ignore      |                                  |                    |
| Soft-off by Power Button   | :Instant off | ESC : Quit                       | ↑↓←→: Select Item  |
| AC Back Function   | :Soft off    | F1 : Help                        | PU/PD/+/- : Modify |
| Modem Use IRQ  | :4           | F5 : Old Values (Shift)F2 :Color |                    |
| Modem Ring On/Wake On Lan  | :Enabled     | F6 : Load BIOS Defaults          |                    |
|  |              | F7 : Load Setup Defaults         |                    |

Figure 5: Power Management Setup

- **ACPI Sleep type**

|        |  |
|--------|--|
| S1/POS | Set ACPI Sleep type is S1 <b>(Default Value)</b> |
| S3/STR | Set ACPI Sleep type is S3.                       |

- **USB KB Wakeup From S3-S5**

|          |   |
|----------|---|
| Enabled  | Enable USB Keyboard Wakeup from system.                         |
| Disabled | Disable USB Keyboard Wakeup from system. <b>(Default Value)</b> |

- **Video Power Down Mode**

|          |   |
|----------|---|
| Disabled | Disabled Video Power Down Mode Function.                      |
| Suspend  | Set Video Power Down Mode to Suspend.                         |
| Stand By | Set Video Power Down Mode to Stand By. <b>(Default Value)</b> |

- **Hard Disk Power Down Mode**

|          |   |
|----------|---|
| Disabled | Disabled Hard Disk Power Down Mode Function.                      |
| Suspend  | Set Hard Disk Power Down Mode to Suspend .                        |
| Stand By | Set Hard Disk Power Down Mode to Stand By. <b>(Default Value)</b> |

● **Suspend Time Out (Minute.)**

|          |  |
|----------|--|
| Disabled | Disabled Suspend Time Out Function. <b>(Default Value)</b> |
| 1        | Enabled Suspend Time Out after 1min.                       |
| 2        | Enabled Suspend Time Out after 2min.                       |
| 4        | Enabled Suspend Time Out after 4min.                       |
| 8        | Enabled Suspend Time Out after 8min.                       |
| 10       | Enabled Suspend Time Out after 10min.                      |
| 20       | Enabled Suspend Time Out after 20min.                      |
| 30       | Enabled Suspend Time Out after 30min.                      |
| 40       | Enabled Suspend Time Out after 40min.                      |
| 50       | Enabled Suspend Time Out after 50min.                      |
| 60       | Enabled Suspend Time Out after 60min.                      |

● **Display Activity**

|         |   |
|---------|---|
| Ignore  | Ignore Display Activity. <b>(Default Value)</b> |
| Monitor | Monitor Display Activity.                       |

● **IRQ 3-IRQ15**

|         |                     |
|---------|---------------------|
| Ignore  | Ignore IRQ3 -IRQ15. |
| Monitor | Monitor IRQ3-IRQ15. |

● **Soft-off by Power Button**

|             |   |
|-------------|---|
| Instant off | Soft switch ON/OFF for Power Button. <b>(Default Value)</b> |
| Delay-4Sec  | Soft switch ON 4 Sec for Power off.                         |

● **AC Back Function**

|          |  |
|----------|--|
| Memory   | This function depends on computer status.          |
| Soft-Off | Set System Soft-Off Status. <b>(Default value)</b> |
| Full-On  | Set System Full-On Status.                         |

● **MODEM Use IRQ**

|    |  |
|----|--|
| NA | Set MODEM Use IRQ to NA.                       |
| 3  | Set MODEM Use IRQ to 3.                        |
| 4  | Set MODEM Use IRQ to 4. <b>(Default Value)</b> |
| 5  | Set MODEM Use IRQ to 5.                        |
| 7  | Set MODEM Use IRQ to 7.                        |

- **Modem Ring on/Wake on LAN**

|          |   |
|----------|---|
| Disabled | Disabled Modem Ring on/Wake on LAN.                       |
| Enabled  | Enabled Modem Ring on/Wake on LAN. <b>(Default Value)</b> |

- **PME Event Wake up**

|          |  |
|----------|--|
| Disabled | Disabled PME Event Wake up function.                       |
| Enabled  | Enabled PME Event Wake up function. <b>(Default Value)</b> |

- **RTC Alarm Power On**

You can set "RTC Alarm Power On" item to Enabled and key in date/time to power on system.

|          |   |
|----------|---|
| Disabled | Disable this function. <b>(Default Value)</b> |
| Enabled  | Enable alarm function to POWER ON system.     |

If the "RTC Alarm Power On" is Enabled.

|                    |                |
|--------------------|----------------|
| RTC Alarm Date :   | Every Day,1~31 |
| RTC Alarm Hour:    | 0~23           |
| RTC Alarm Minute : | 0~59           |
| RTC Alarm Second : | 0~59           |

PnP/PCI Configurations

| AMIBIOS SETUP –PNP/PCI CONFIGURATION SETUP<br>( C ) 1999 American Megatrends, Inc. All Rights Reserved |           |  |
|--|-----------|--|
| Plug and Play Aware O/S  | :No       |  |
| Reset Configuration Data   | :No       |  |
| VGA Boot From  | :AGP      |  |
| PCI VGA Palette Snoop  | :Disabled |  |
| DMA Channel 0  | :PnP      |  |
| DMA Channel 1  | :PnP      |  |
| DMA Channel 3  | :PnP      |  |
| DMA Channel 5  | :PnP      |  |
| DMA Channel 6  | :PnP      |  |
| DMA Channel 7  | :PnP      |  |
| IRQ 3  | :PCI/PnP  |  |
| IRQ 4  | :PCI/PnP  |  |
| IRQ 5  | :PCI/PnP  |  |
| IRQ 7  | :PCI/PnP  |  |
| IRQ 9  | :PCI/PnP  |  |
| IRQ 10   | :PCI/PnP  |  |
| IRQ 11   | :PCI/PnP  |  |
| IRQ 14   | :PCI/PnP  |  |
| IRQ 15   | :PCI/PnP  |  |
|  |           | ESC : Quit                   ↑↓←→: Select Item<br>F1 : Help                    PU/PD/+/- : Modify<br>F5 : Old Values (Shift)F2 :Color<br>F6 : Load BIOS Defaults<br>F7 : Load Setup Defaults |

Figure 6: PnP/PCI Configuration

- **Plug and Play Aware O/S**

|     |   |
|-----|---|
| Yes | Enable Plug and Play Aware O/S function.                          |
| No  | Disable Plug and Play Aware O/S function ( <b>Default Value</b> ) |

- **Reset Configuration Data**

|     |  |
|-----|--|
| No  | Disable this function. ( <b>Default value</b> )  |
| Yes | Clear PnP information in ESCD & update DMI data. |

- **VGA Boot From**

|     |   |
|-----|---|
| AGP | Primary Graphics Adapter From AGP. ( <b>Default Value</b> ) |
| PCI | Primary Graphics Adapter From PCI.                          |

- **PCI VGA Palette Snoop**

|          |   |
|----------|---|
| Enabled  | For having Video Card on ISA Bus and VGA Card on PCI Bus. |
| Disabled | For VGA Card only. ( <b>Default Value</b> )               |

- **DMA Channel (0,1,3,5,6,7)**

|           |   |
|-----------|---|
| PnP       | The resource is used by PnP device.                     |
| ISA/ EISA | The resource is used by ISA / EISA device (PCI or ISA). |

- **IRQ (3,4,5,7, 9,10,11,14,15)**

|           |   |
|-----------|---|
| PCI/PnP   | The resource is used by PCI/PnP device.                 |
| ISA/ EISA | The resource is used by ISA / EISA device (PCI or ISA). |



Load BIOS Defaults

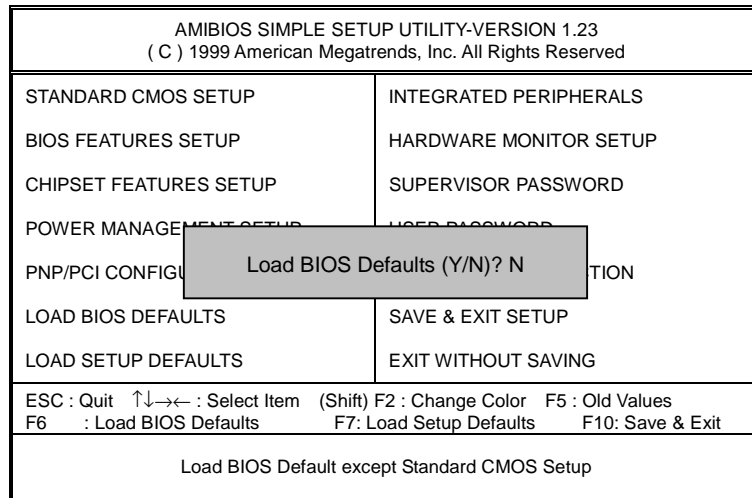

Figure 7: Load BIOS Defaults

- **Load BIOS Defaults**

BIOS defaults contain the most appropriate values of the system parameters that allow minimum system performance.

## Load Setup Defaults

| AMIBIOS SIMPLE SETUP UTILITY-VERSION 1.23<br>( C ) 1999 American Megatrends, Inc. All Rights Reserved   |                              |
|---|------------------------------|
| STANDARD CMOS SETUP   | INTEGRATED PERIPHERALS       |
| BIOS FEATURES SETUP   | HARDWARE MONITOR SETUP       |
| CHIPSET FEATURES SETUP  | SUPERVISOR PASSWORD          |
| POWER MANAGEMENT SETUP  | USER PASSWORD                |
| PNP/PCI CONFIGURATION   | IDE HDD AUTO DETECTION       |
| LOAD BIOS DEFAULTS  | Load SETUP Defaults (Y/N)? N |
| LOAD SETUP DEFAULTS   | EXIT WITHOUT SAVING          |
| ESC : Quit   ↑↓→← : Select Item   (Shift) F2 : Change Color   F5 : Old Values<br>F6 : Load BIOS Defaults   F7: Load Setup Defaults   F10: Save & Exit |                              |
| Load Setup Default except Standard CMOS Setup   |                              |

Figure 8: Load Setup Defaults

- **Load Setup Defaults**

Selecting this field loads the factory defaults for BIOS and Chipset Features which the system automatically detects.

Integrated Peripherals

| AMIBIOS SETUP –INTEGRATED PERIPHERAL<br>( C ) 1999 American Megatrends, Inc. All Rights Reserved |         |
|--|---------|
| OnBoard IDE  | :Both   |
| OnBoard FDC  | :Auto   |
| OnBoard Serial Port 1  | :Auto   |
| OnBoard Serial Port 2  | :Auto   |
| Serial Port 2 Mode   | :Normal |
| Duplex Mode  | :N/A    |
| OnBoard Parallel Port  | :Auto   |
| Parallel Port Mode   | :ECP    |
| Parallel Port DMA  | :Auto   |
| Parallel Port IRQ  | :Auto   |
| OnBoard AC'97 Audio  | :Auto   |
| OnBoard MC'97 Modem  | :Auto   |

|                          |                    |
|--------------------------|--------------------|
| ESC : Quit               | ↑↓←→: Select Item  |
| F1 : Help                | PU/PD/+/- : Modify |
| F5 : Old Values          | (Shift)F2 :Color   |
| F6 : Load BIOS Defaults  |                    |
| F7 : Load Setup Defaults |                    |

Figure 9: Integrated Peripherals

- **OnBoard IDE**

|           |   |
|-----------|---|
| Disabled  | Disabled OnBoard IDE                            |
| Both      | Set Onboard IDE is Both. <b>(Default Value)</b> |
| Primary   | Set Onboard IDE is Primary.                     |
| Secondary | Set Onboard IDE is Secondary.                   |

- **OnBoard FDC**

|          |   |
|----------|---|
| Auto     | Set Onboard FDC is Auto. <b>(Default Value)</b> |
| Disabled | Disabled Onboard FDC.                           |
| Enabled  | Enabled Onboard FDC.                            |

- **OnBoard Serial Port 1**

|          |  |
|----------|--|
| Auto     | BIOS will automatically setup the port 1 address. <b>(Default Value)</b> |
| 3F8/COM1 | Enable Onboard Serial port 1 and address is 3F8.                         |
| 2F8/COM2 | Enable Onboard Serial port 1 and address is 2F8.                         |
| 3E8/COM3 | Enable Onboard Serial port 1 and address is 3E8.                         |
| 2E8/COM4 | Enable Onboard Serial port 1 and address is 2E8.                         |
| Disabled | Disable Onboard Serial port 1.   |

- **OnBoard Serial Port 2**

|          |  |
|----------|--|
| Auto     | BIOS will automatically setup the port 2 address. <b>(Default Value)</b> |
| 3F8/COM1 | Enable Onboard Serial port 2 and address is 3F8.                         |
| 2F8/COM2 | Enable Onboard Serial port 2 and address is 2F8.                         |
| 3E8/COM3 | Enable Onboard Serial port 2 and address is 3E8.                         |
| 2E8/COM4 | Enable Onboard Serial port 2 and address is 2E8.                         |
| Disabled | Disable Onboard Serial port 2.   |

- **Serial Port 2 Mode**

(This item allows you to determine which Serial Port 2 Mode of onboard I/O chip)

|        |   |
|--------|---|
| ASKIR  | Set onboard I/O chip Serial Port 2 to ASKIR Mode.                         |
| IrDA   | Set onboard I/O chip Serial Port 2 to IrDA Mode.                          |
| Normal | Set onboard I/O chip Serial Port 2 to Normal Mode. <b>(Default Value)</b> |

- **Duplex Mode**

|             |  |
|-------------|--|
| Half Duplex | IR Function Duplex Half.                       |
| N/A         | Disabled this function. <b>(Default Value)</b> |
| Full Duplex | IR Function Duplex Full.                       |

- **OnBoard Parallel port**

|          |  |
|----------|--|
| 378      | Enable Onboard LPT port and address is 378.          |
| 278      | Enable Onboard LPT port and address is 278.          |
| 3BC      | Enable Onboard LPT port and address is 3BC.          |
| Auto     | Set Onboard LPT port is Auto. <b>(Default Value)</b> |
| Disabled | Disable Onboard LPT port.                            |

- **Parallel Port Mode**

|        |   |
|--------|---|
| EPP    | Using Parallel port as Enhanced Parallel Port.                            |
| ECP    | Using Parallel port as Extended Capabilities Port. <b>(Default Value)</b> |
| Normal | Normal Operation.   |

- **Parallel Port DMA**

|      |  |
|------|--|
| Auto | Set Auto to parallel port mode DMA Channel. <b>(Default Value)</b> |
| 3    | Set Parallel Port DMA is 3.  |
| 1    | Set Parallel Port DMA is 1.  |
| 0    | Set Parallel Port DMA is 0.  |

---

- **Parallel Port IRQ**

|      |   |
|------|---|
| 7    | Set Parallel Port IRQ is 7.                                       |
| Auto | Set Auto to parallel Port IRQ DMA Channel. <b>(Default Value)</b> |
| 5    | Set Parallel Port IRQ is 5.                                       |

- **OnBoard AC'97 Audio**

|          |  |
|----------|--|
| Auto     | Set AC'97 Audio to Auto <b>(Default Value)</b> . |
| Disabled | Disabled AC'97 Audio.                            |

- **OnBoard MC'97 Modem**

|          |  |
|----------|--|
| Auto     | Set MC'97 Modem to Auto <b>(Default Value)</b> . |
| Disabled | Disabled MC'97 Modem.                            |

## Hardware Monitor

| AMBIOS SETUP –HARDWARE MONITOR<br>( C ) 1999 American Megatrends, Inc. All Rights Reserved   |            |
|--|------------|
| ACPI Shut Down Temp.   | :Disabled  |
| Current CPU Temp.  | :36°C/96°F |
| Current System Temp.   | :28°C/82°F |
| Case Status  | :Closed    |
| Current CPU Fan Speed  | :5487 RPM  |
| Current System Fan Speed   | :0 RPM     |
| Vcore  | :1.634V    |
| +3.300V  | :3.590V    |
| +5.000V  | :5.119V    |
| +12.000V   | :11.926V   |
| ESC : Quit                    ↑↓←→: Select Item<br>F1 : Help                      PU/PD/+/- : Modify<br>F5 : Old Values            (Shift)F2 :Color<br>F6 : Load BIOS Defaults<br>F7 : Load Setup Defaults |            |

Figure 10: Hardware Monitor

- **ACPI Shutdown Temp. (°C / °F)**

(This function will be effective only for the operating systems that support ACPI Function.)

| Disabled     | Normal Operation. <b>(Default value)</b>  |
|--------------|---|
| 60°C / 140°F | Monitor CPU Temp. at 60°C / 140°F, if Temp. > 60°C / 140°F system will automatically power off. |
| 70°C / 158°F | Monitor CPU Temp. at 70°C / 158°F, if Temp. > 70°C / 158°F system will automatically power off. |
| 80°C / 176°F | Monitor CPU Temp. at 80°C / 176°F, if Temp. > 80°C / 176°F system will automatically power off. |
| 90°C / 194°F | Monitor CPU Temp. at 90°C / 194°F, if Temp. > 90°C / 194°F system will automatically power off. |

- **Current CPU Temp. (°C / °F)**  
Detect CPU Temperature automatically.
- **Current System Temp. (°C / °F)**  
Detect System Temperature automatically.
- **Case Status**  
If the case is closed, "Case Status" will show "Closed".  
If the case have been opened, "Case Opened" will show "Open".
- **Current CPU FAN Speed**  
Detect CPU Fan speed status automatically .
- **Current System FAN Speed**  
Detect System Fan speed status automatically .
- **Current Voltage (V) VCORE / +3.3V / +12V / +5V**  
Detect system's voltage status automatically.

## Set Supervisor / User Password

When you select this function, the following message will appear at the center of the screen to assist you in creating a password.

| AMIBIOS SIMPLE SETUP UTILITY-VERSION 1.23<br>( C ) 1999 American Megatrends, Inc. All Rights Reserved   |                        |
|---|------------------------|
| STANDARD CMOS SETUP   | INTEGRATED PERIPHERALS |
| BIOS FEATURES SETUP   | HARDWARE MONITOR SETUP |
| CHIPSET FEATURES SETUP  | SUPERVISOR PASSWORD    |
| POWER MANAGEMENT SETUP  | USER PASSWORD          |
| PNP/PCI CONFIGURATION   | SAVE & EXIT SETUP      |
| LOAD BIOS DEFAULTS  | EXIT WITHOUT SAVING    |
| LOAD SETUP DEFAULTS   |                        |
| ESC : Quit   ↑↓→← : Select Item   (Shift) F2 : Change Color   F5 : Old Values<br>F6 : Load BIOS Defaults   F7: Load Setup Defaults   F10: Save & Exit |                        |
| Enter new supervisor password:  |                        |
| Chang /Set /Disabled Password   |                        |

Figure 11: Password Setting

Type the password, up to six characters, and press <Enter>. You will be asked to confirm the password. Type the password again and press <Enter>. You may also press <Esc> to abort the selection and not enter a password.

To disable password, just press <Enter> when you are prompted to enter password. A message **"PASSWORD DISABLED"** will appear to confirm the password being disabled. Once the password is disabled, the system will boot and you can enter Setup freely.

The BIOS Setup program allows you to specify two separate passwords: a **SUPERVISOR PASSWORD** and a **USER PASSWORD**. When disabled, anyone may access all BIOS Setup program function. When enabled, the Supervisor password is required for entering the BIOS Setup program and having full configuration fields, the User password is required to access only basic items.

If you select **"Always"** at **"Password Check"** in BIOS Features Setup Menu, you will be prompted for the password every time the system is rebooted or any time you try to enter Setup Menu.

If you select **"Setup"** at **"Password Check"** in BIOS Features Setup Menu, you will be prompted only when you try to enter Setup.



IDE HDD AUTO Detection

| AMBIOS SETUP – STANDARD CMOS SETUP<br>( C ) 1999 American Megatrends, Inc. All Rights Reserved |                 |      |                    |                       |       |                   |      |
|--|-----------------|------|--------------------|-----------------------|-------|-------------------|------|
| Date (mm/dd/yyyy) : Thu Feb 24, 2000<br>Time (hh/mm/ss) : 10:36:24                             |                 |      |                    |                       |       |                   |      |
| TYPE   | SIZE            | CYLS | HEAD               | PRECOMP               | LANDZ | SECTOR            | MODE |
| Pri Master   | : Not Installed |      |                    |                       |       |                   |      |
| Pri Slave  | : Not Installed |      |                    |                       |       |                   |      |
| Sec Master   | : Not Installed |      |                    |                       |       |                   |      |
| Sec Slave  | : Not Installed |      |                    |                       |       |                   |      |
| Floppy Drive A:  | 1.44 MB 3 ½     |      |                    | Base Memory : 640 Kb  |       |                   |      |
| Floppy Drive B:  | Not Installed   |      |                    | Other Memory: 384 Kb  |       |                   |      |
| Boot Sector Virus Protection : Disabled  |                 |      |                    | Extended Memory: 31Mb |       |                   |      |
|  |                 |      |                    | Total Memory: 32Mb    |       |                   |      |
| Month:   | Jan – Dec       |      | ESC : Exit         |                       |       |                   |      |
| Day:   | 01 – 31         |      | ↑↓ : Select Item   |                       |       |                   |      |
| Year:  | 1990– 2099      |      | PU/PD/+/- : Modify |                       |       | (Shift)F2 : Color |      |

Figure 12: IDE HDD Auto Detection

Type "Y" will accept the H.D.D. parameter reported by BIOS.

Type "N" will keep the old H.D.D. parameter setup. If the hard disk cylinder number is over 1024, then the user can select LBA mode or LARGER mode for DOS partition larger than 528 MB.

## Save & Exit Setup

|   |                               |
|---|-------------------------------|
| AMIBIOS SIMPLE SETUP UTILITY-VERSION 1.23<br>( C ) 1999 American Megatrends, Inc. All Rights Reserved   |                               |
| STANDARD CMOS SETUP   | INTEGRATED PERIPHERALS        |
| BIOS FEATURES SETUP   | HARDWARE MONITOR SETUP        |
| CHIPSET FEATURES SETUP  | SUPERVISOR PASSWORD           |
| POWER MANAGEMENT SETUP  | USER PASSWORD                 |
| PNP/PCI CONFIGURATION   |                               |
| LOAD BIOS DEFAULTS  | SAVE to CMOS and EXIT(Y/N)? Y |
| LOAD SETUP DEFAULTS   | EXIT WITHOUT SAVING           |
| ESC : Quit   ↑↓→← : Select Item   (Shift) F2 : Change Color   F5 : Old Values<br>F6 : Load BIOS Defaults   F7: Load Setup Defaults   F10: Save & Exit |                               |
| Save Data to CMOS & Exit Setup  |                               |

Figure 13: Save & Exit Setup

Type "Y" will quit the Setup Utility and save the user setup value to RTC CMOS.

Type "N" will return to Setup Utility.

Exit Without Saving

|  |                               |
|--|-------------------------------|
| AMIBIOS SIMPLE SETUP UTILITY-VERSION 1.23<br>( C ) 1999 American Megatrends, Inc. All Rights Reserved  |                               |
| STANDARD CMOS SETUP  | INTEGRATED PERIPHERALS        |
| BIOS FEATURES SETUP  | HARDWARE MONITOR SETUP        |
| CHIPSET FEATURES SETUP   | SUPERVISOR PASSWORD           |
| POWER MANAGEMENT SETUP   | USER PASSWORD                 |
| PNP/PCI CONFIGURATION  |                               |
| LOAD BIOS DEFAULTS   | Quit without saving (Y/N) ? N |
| LOAD SETUP DEFAULTS  | EXIT WITHOUT SAVING           |
| ESC : Quit    ↑↓→← : Select Item    (Shift) F2 : Change Color    F5 : Old Values<br>F6 : Load BIOS Defaults    F7: Load Setup Defaults    F10: Save & Exit |                               |
| Abandon all Datas & Exit Setup   |                               |

Figure 14: Exit Without Saving

Type "Y" will quit the Setup Utility without saving to RTC CMOS.

Type "N" will return to Setup Utility.

## Appendix

### Appendix A : VIA Chipsets Driver Installation

#### A.VIA 4 in 1 Service Pack Utility:

Insert the support CD that came with your motherboard into your CD-ROM driver or double-click the CD driver icon in My Computer to bring up the screen.

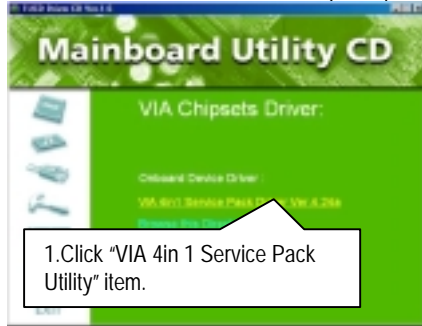

(1)

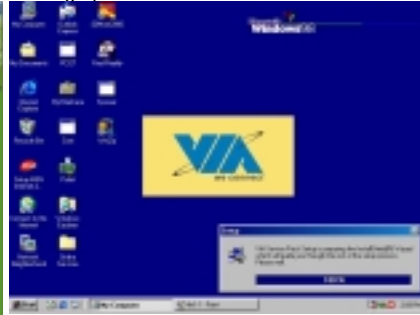

(2)

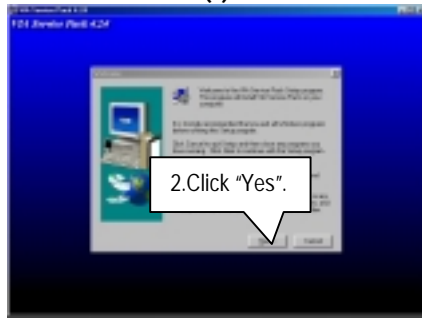

(3)

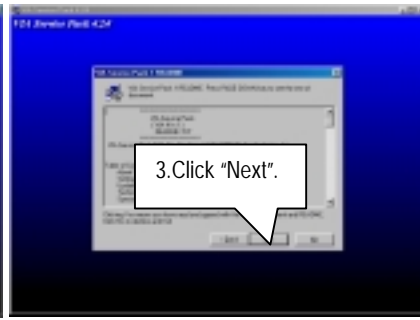

(4)

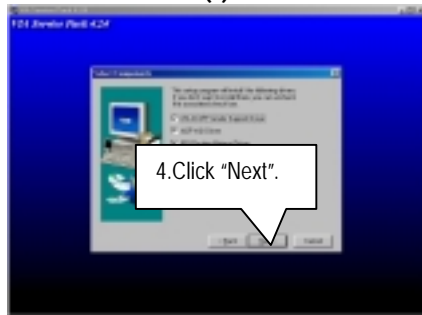

(5)

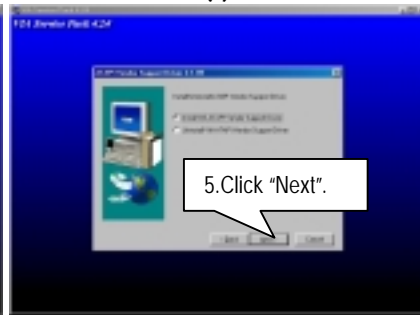

(6)

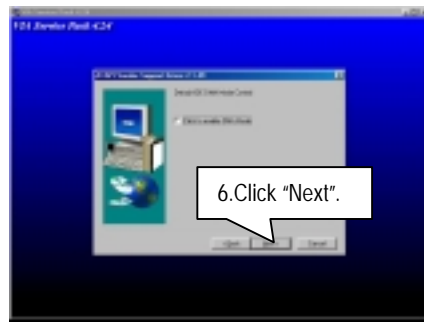

(7)

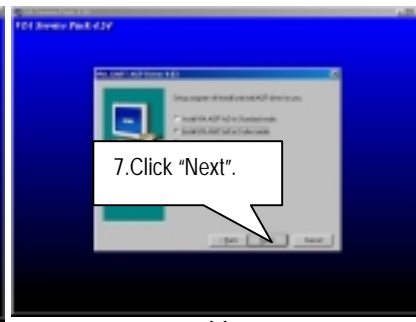

(8)

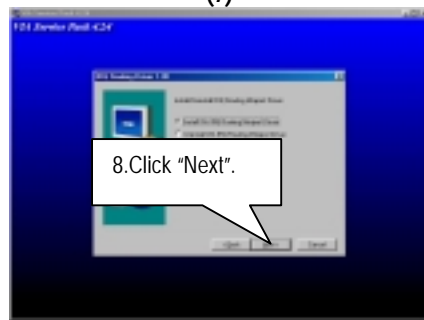

(9)



(10)

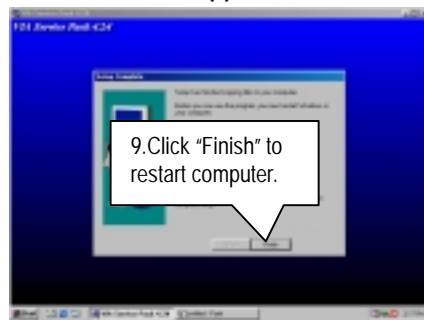

## Appendix B: BIOS Flash Procedure

BIOS update procedure:

If your OS is Win9X, we recommend that you used Gigabyte @BIOS Program to flash BIOS.

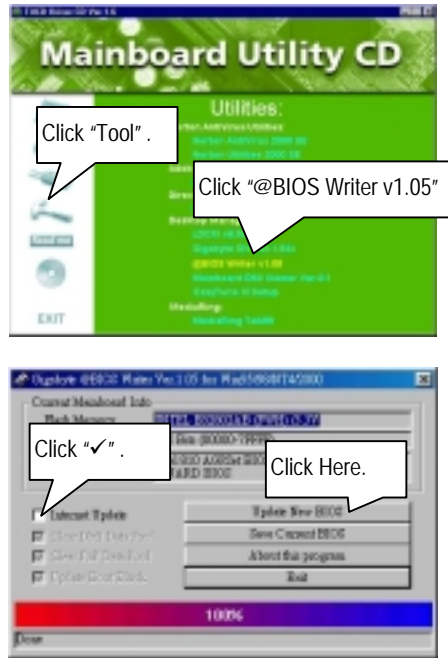

Methods and steps :

### I. Update BIOS through Internet

- a. Click "Internet Update" icon
- b. Click "Update New BIOS" icon
- c. Select @BIOS sever ( "Gigabyte @BIOS sever 1 in Taiwan" and "Gigabyte @BIOS sever 2 in Taiwan" are available for now, the others will be completed soon)
- d. Select the exact model name on your motherboard
- e. System will automatically download and update the BIOS.

II. Update BIOS **NOT** through Internet :

- a. **Do not** click "Internet Update" icon
- b. Click "Update New BIOS"
- c. Please select "All Files" in dialog box while opening the old file.
- d. Please search for BIOS unzip file, downloading from internet or any other methods (such as: 6vx7-1394.F1).
- e. Complete update process following the instruction.

III. Save BIOS

In the very beginning, there is "Save Current BIOS" icon shown in dialog box. It means to save the current BIOS version.

IV. Check out supported motherboard and Flash ROM :

In the very beginning, there is "About this program" icon shown in dialog box. It can help you check out which kind of motherboard and which brand of Flash ROM are supported.

Note :

- a. In method I, if it shows two or more motherboard's model names to be selected, please make sure your motherboard's model name again. Selecting name will cause the system unbooted.
- b. In method II, be sure that motherboard's model name in BIOS unzip file are the same as your motherboard's. Otherwise, your system won't boot.
- c. In method I, if the BIOS file you need cannot be found in @BIOS server, please go onto Gigabyte's web site for downloading and updating it according to method II.
- d. Please note that any intercorruption during updating will cause system unbooted

Or else you can select flash BIOS in DOS mode.

● Please check your **BIOS vendor (AMI or AWARD)**, your **motherboard name** and **PCB version** on the motherboard.

1. Format a bootable system floppy diskette by the command "**format a:/s**" in command mode.
2. Visit the Gigabyte website at [http:// www.gigabyte.com.tw](http://www.gigabyte.com.tw). Select the BIOS file you need and download it to your bootable floppy diskette.
3. Insert the bootable diskette containing the BIOS file into the floppy diskette driver.
4. Assuming that the floppy diskette driver is A, reboot the system by using the A: driver. At the A: > prompt, run the BIOS upgraded file by executing the Flash BIOS utility and the BIOS file with its appropriate extension.

Example: *(AMI tool) (Where 6vx7-1394.f1 is name of the BIOS file name)*

```
A:>flashxxx.exe 6vx7-1394.f1 ↵
```

Example: *(Award tool) (Where 6vx7-1394.f1 is name of the BIOS file name)*

```
A:>wdfash.exe 6vx7-1394.f1 ↵
```

5. Upon pressing the <Enter> key, a flash memory writer menu will appear on screen. Enter the new BIOS file name with its extension filename into the text box after file name to program.
6. If you want to save the old BIOS file(perform as soon as system is operational, this is recommended), select Y to **DO YOU WANT TO SAVE BIOS**, then type the old BIOS filename and the extension after filename to save: This option allows you to copy the contents of the flash memory chip onto a diskette, giving you a backup copy of the original motherboard BIOS in case you need to re-install it. Select N to **DO YOU WANT TO SAVE BIOS**, if you don't want to save the old BIOS file.
7. After the decision to save the old BIOS file or not is made, select Y to **ARE YOU SURE TO PROGRAM** when the next menu appear; wait until a message showing Power Off or Reset the system appears. Then turn off your system.
8. Remove the diskette and restart your system.
9. Hold down <Delete> key to enter BIOS setup. You must select "Load Setup BIOS Default" to activate the new BIOS, then you may set other item from the main menu.



## Appendix C: Acronyms

| Acronyms | Meaning   |
|----------|---|
| ACPI     | Advanced Configuration and Power Interface          |
| APM      | Advanced Power Management                           |
| AGP      | Accelerated Graphics Port                           |
| AMR      | Audio Modem Riser                                   |
| ACR      | Advanced Communication Riser                        |
| BIOS     | Basic Input / Output System                         |
| CPU      | Central Processing Unit                             |
| CMOS     | Complementary Metal Oxide Semiconductor             |
| CRIMM    | Continuity RIMM                                     |
| CNR      | Communication and Networking Riser                  |
| DMA      | Direct Memory Access                                |
| DMI      | Desktop Management Interface                        |
| DIMM     | Dual Inline Memory Module                           |
| DRM      | Dual Retention Mechanism                            |
| DRAM     | Dynamic Random Access Memory                        |
| DDR      | Double Data Rate                                    |
| ECP      | Extended Capabilities Port                          |
| ESCD     | Extended System Configuration Data                  |
| ECC      | Error Checking and Correcting                       |
| EMC      | Electromagnetic Compatibility                       |
| EPP      | Enhanced Parallel Port                              |
| ESD      | Electrostatic Discharge                             |
| FDD      | Floppy Disk Device                                  |
| FSB      | Front Side Bus                                      |
| HDD      | Hard Disk Device                                    |
| IDE      | Integrated Dual Channel Enhanced                    |
| IRQ      | Interrupt Request                                   |
| I/O      | Input / Output                                      |
| IOAPIC   | Input Output Advanced Programmable Input Controller |
| ISA      | Industry Standard Architecture                      |
| LAN      | Local Area Network                                  |
| LBA      | Logical Block Addressing                            |
| LED      | Light Emitting Diode                                |
| MHz      | Megahertz   |
| MIDI     | Musical Interface Digital Interface                 |
| MTH      | Memory Translator Hub                               |
| MPT      | Memory Protocol Translator                          |
| NIC      | Network Interface Card                              |
| OS       | Operating System                                    |

To be continued...

| Acronyms | Meaning                           |
|----------|-----------------------------------|
| OEM      | Original Equipment Manufacturer   |
| PAC      | PCI A.G.P. Controller             |
| POST     | Power-On Self Test                |
| PCI      | Peripheral Component Interconnect |
| RIMM     | Rambus in-line Memory Module      |
| SCI      | Special Circumstance Instructions |
| SECC     | Single Edge Contact Cartridge     |
| SRAM     | Static Random Access Memory       |
| SMP      | Symmetric Multi-Processing        |
| SMI      | System Management Interrupt       |
| USB      | Universal Serial Bus              |
| VID      | Voltage ID                        |