

FCC Compliance Statement:

<p>DECLARATION OF CONFORMITY Per FCC Part 2 Section 2.1077(a)</p> <p>FCC</p> <p>Responsible Party Name: G.R.T. INC. Address: 18385 Valley Blvd., Suite#A LA Puente, CA 91744 Phone/Fax No: (818) 854-9338/ (818) 854-9339</p> <p>hereby declares that the product Product Name: Mother Board Model Number: GA-6VTXE-A</p> <p>Conforms to the following specifications: FCC Part 15, Subpart B, Section 15.107(a) and Section 15.109(a), Class B Digital Device</p> <p>Supplementary Information: This device complies with part 15 of the FCC Rules. Operation is subject to the following two conditions: (1) This device may not cause harmful interference and (2) this device must accept any interference received, including that may cause undesired operation.</p> <p>Representative Person's Name: <u>ERIC LU</u> Signature: <u>Eric Lu</u> Date: <u>May 10, 2002</u></p>
--

This equipment has been tested and found to comply with limits for a Class B digital device, pursuant to Part 15 of the FCC rules. These limits are designed to provide reasonable protection against harmful interference in residential installations. This equipment generates, uses, and can radiate radio frequency energy, and if not installed and used in accordance with the instructions, may cause harmful interference to radio communications. However, there is no guarantee that interference will not occur in a particular installation. If this equipment does cause interference to radio or television equipment reception, which can be

determined by turning the equipment off and on, the user is encouraged to try to correct the interference by one or more of the following measures:

- Reorient or relocate the receiving antenna
- Move the equipment away from the receiver
- Plug the equipment into an outlet on a circuit different from that to which the receiver is connected
- Consult the dealer or an experienced radio/television technician for additional suggestions

You are cautioned that any change or modifications to the equipment not expressly approved by the party responsible for compliance could void Your authority to operate such equipment.

This device complies with Part 15 of the FCC Rules. Operation is subjected to the following two conditions 1) this device may not cause harmful interference and 2) this device must accept any interference received, including interference that may cause undesired operation.

Declaration of Conformity

We, Manufacturer/Importer
(full address)

G.B.T. Technology Trading GmbH
Ausschlagler Weg 41, 1F, 20537 Hamburg, Germany

declare that the product
(description of the apparatus, system, installation to which it refers)

Mother Board
GA-6VTXE-A

is in conformity with
(reference to the specification under which conformity is declared)
in accordance with 89/336 EEC-EMC Directive

- | | | | |
|---|--|---|--|
| <input type="checkbox"/> EN 55011 | Limits and methods of measurement of radio disturbance characteristics of industrial, scientific and medical (ISM) high frequency equipment | <input type="checkbox"/> EN 61000-3-2*
<input checked="" type="checkbox"/> EN60555-2 | Disturbances in supply systems caused by household appliances and similar electrical equipment "Harmonics" |
| <input type="checkbox"/> EN55013 | Limits and methods of measurement of radio disturbance characteristics of broadcast receivers and associated equipment | <input type="checkbox"/> EN61000-3-3*
<input checked="" type="checkbox"/> EN60555-3 | Disturbances in supply systems caused by household appliances and similar electrical equipment "Voltage fluctuations" |
| <input type="checkbox"/> EN 55014 | Limits and methods of measurement of radio disturbance characteristics of household electrical appliances, portable tools and similar electrical apparatus | <input checked="" type="checkbox"/> EN 50081-1
<input checked="" type="checkbox"/> EN 50082-1 | Generic emission standard Part 1: Residual, commercial and light industry
Generic immunity standard Part 1: Residual, commercial and light industry |
| <input type="checkbox"/> EN 55015 | Limits and methods of measurement of radio disturbance characteristics of fluorescent lamps and luminaries | <input type="checkbox"/> EN 55081-2 | Generic emission standard Part 2: Industrial environment |
| <input type="checkbox"/> EN 55020 | Immunity from radio interference of broadcast receivers and associated equipment | <input type="checkbox"/> EN 55082-2 | Generic immunity standard Part 2: Industrial environment |
| <input checked="" type="checkbox"/> EN 55022 | Limits and methods of measurement of radio disturbance characteristics of information technology equipment | <input type="checkbox"/> ENV 55104 | Immunity requirements for household appliances tools and similar apparatus |
| <input type="checkbox"/> DIN VDE 0855
<input type="checkbox"/> part 10
<input type="checkbox"/> part 12 | Cabled distribution systems; Equipment for receiving and/or distribution from sound and television signals | <input type="checkbox"/> EN 50091- 2 | EMC requirements for uninterruptible power systems (UPS) |
| <input checked="" type="checkbox"/> CE marking | |  (EC conformity marking) | |

The manufacturer also declares the conformity of above mentioned product with the actual required safety standards in accordance with LVD 73/23 EEC

- | | | | |
|-----------------------------------|---|-------------------------------------|---|
| <input type="checkbox"/> EN 60065 | Safety requirements for mains operated electronic and related apparatus for household and similar general use | <input type="checkbox"/> EN 60950 | Safety for information technology equipment including electrical business equipment |
| <input type="checkbox"/> EN 60335 | Safety of household and similar electrical appliances | <input type="checkbox"/> EN 50091-1 | General and Safety requirements for uninterruptible power systems (UPS) |

Manufacturer/Importer

(Stamp)

Date : May. 10, 2002

Signature : Rex Lin
Name : Rex Lin

6VTXE(-A)
Socket 370 Processor Motherboard

USER'S MANUAL

Socket 370 Processor Motherboard
REV. 1004
12ME-6VTXE-1004

How This Manual Is Organized

This manual is divided into the following sections:

1) Revision History	Manual revision information
2) Item Checklist	Product item list
3) Features	Product information & specification
4) Hardware Setup	Instructions on setting up the motherboard
5) Block Diagram	Block diagram
6) BIOS Setup	Instructions on setting up the BIOS software
7) Appendix	General reference

Table Of Content

Revision History	P.1
Item Checklist	P.2
Summary of Features	P.3
6VTXE(-A) Motherboard Layout	P.5
Page Index for CPU Speed Setup / Connectors / Panel and Jumper Definition	P.6
Block Diagram	P.25
Memory Installation	P.26
Page Index for BIOS Setup	P.27
Appendix	P.56

Revision History

Revision	Revision Note	Date
1.0	Initial release of the 6VTXE motherboard user's manual.	Aug. 2001
1.0	Second release of the 6VTXE motherboard user's manual.	Oct. 2001
1.0	Third release of the 6VTXE motherboard user's manual.	Jan. 2002
1.0	Fourth release of the 6VTXE(-A) motherboard user's manual.	May. 2002

The author assumes no responsibility for any errors or omissions that may appear in this document nor does the author make a commitment to update the information contained herein.

Third-party brands and names are the property of their respective owners.

Please do not remove any labels on motherboard, this may void the warranty of this motherboard.

May. 06, 2002 Taipei, Taiwan, R.O.C

Item Checklist

- The 6VTXE(-A) motherboard
- Cable for IDE / floppy device
- Diskettes or CD for motherboard driver & utility
- 6VTXE(-A) user's manual

Summary Of Features

Form Factor	<ul style="list-style-type: none"> 30.5 cm x 18.0 cm ATX size form factor, 4 layers PCB.
CPU	<ul style="list-style-type: none"> Socket 370 processor <ul style="list-style-type: none"> Supports all new PentiumIII processors (FC-PGA & FC-PGA2 package) Supports Celeron processors in FC-PGA package Supports 66/100/133MHz system bus frequency Can't support processor with Vcore above 1.8V 2nd cache in CPU (Depend on CPU)
Chipset	<ul style="list-style-type: none"> VT82C694T (VIA Apollo Pro 133T) VT82C686B
Clock Generator	<ul style="list-style-type: none"> ICS 9248DF-39 66/100/133 MHz system bus speeds (PCI 33MHz) 75/83/112/124/140/150 MHz system bus speeds (PCI 44MHz) (reserved)
Memory	<ul style="list-style-type: none"> 3 168-pin DIMM sockets. Supports PC-100 / PC-133 SDRAM and VCM SDRAM Supports up to 1.5GB DRAM Supports only 3.3V SDRAM DIMM Supports 72bit ECC type DRAM integrity mode.
I/O Control	<ul style="list-style-type: none"> VT82C686B
Slots	<ul style="list-style-type: none"> 1 AGP slot supports 4X mode & AGP 2.0 compliant 5 PCI slot supports 33MHz & PCI 2.2 compliant 1 AMR(Audio Modem Riser) slot 1 16-bit ISA Bus slots
On-Board IDE	<ul style="list-style-type: none"> 2 IDE bus master (UDMA 33/ ATA 66 /ATA100)IDE ports for up to 4 ATAPI devices Supports PIO mode 3, 4 (DMA 33/ATA 66) IDE & ATAPI CD-ROM
On-Board Peripherals	<ul style="list-style-type: none"> 1 floppy port supports 2 FDD with 360K, 720K,1.2M, 1.44M and 2.88M bytes 1 parallel ports supports SPP/EPP/ECP mode 2 serial ports (COM A & COM B) 2 USB ports 1 IrDA connector for Fast IrDA

To be continued...

Summary of Features

Hardware Monitor	<ul style="list-style-type: none">• CPU / System fan revolution detect• CPU / System temperature detect• System voltage detect (Vcore,Vcc3,Vcc,+12V)• ACPI Shutdown Temperature
Onboard Sound	<ul style="list-style-type: none">• SigmaTel 9721T CODEC• AUX_IN/CD_IN/GAME Port/Line In/Line Out/MIC in
PS/2 Connector	<ul style="list-style-type: none">• PS/2[®] Keyboard interface and PS/2[®] Mouse interface
BIOS	<ul style="list-style-type: none">• Licensed AMI BIOS, 2M bit flash ROM
Additional Features	<ul style="list-style-type: none">• Support Wake-On-LAN (WOL)• Support Internal / External Modem Ring On.• Includes 2 fan power connectors.• Poly fuse for keyboard over-current protection

6VTXE(-A) Motherboard Layout

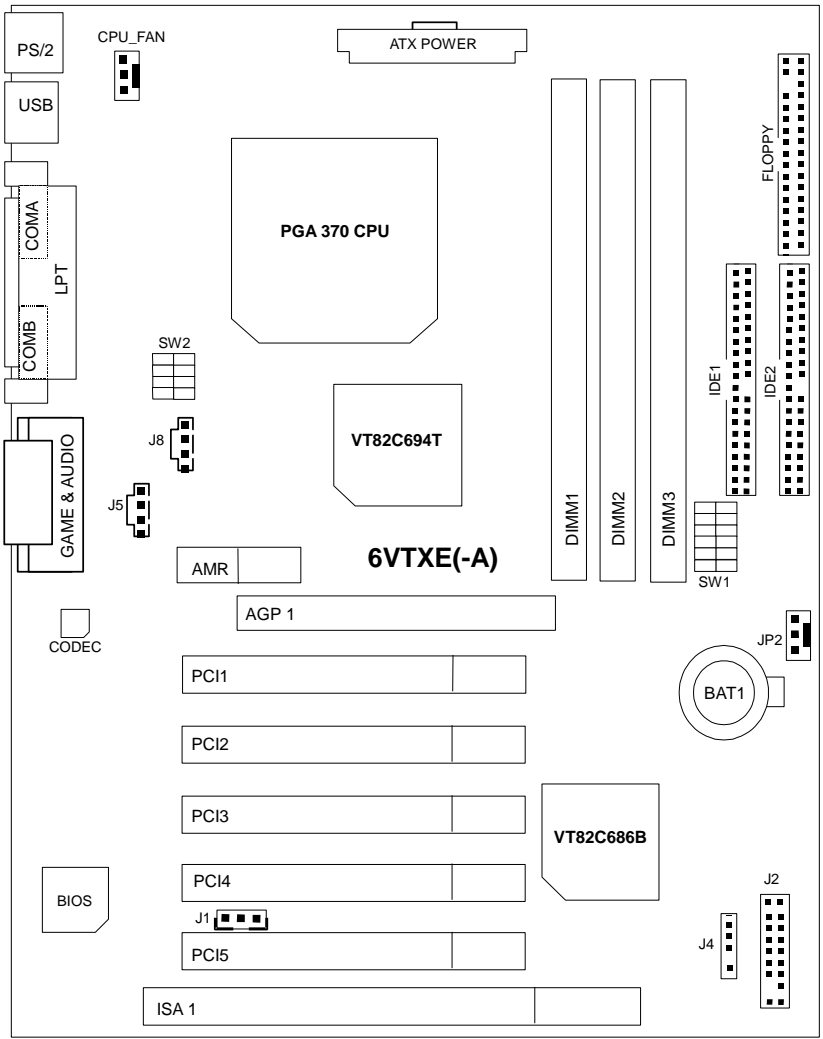

 Page Index for CPU Speed Setup / Connectors / Panel and Jumper Definition	Page
CPU Speed Setup	P.7
Connectors	P.16
COM A / COM B / LPT Port	P.16
Game & Audio Port	P.16
USB Connector	P.17
PS/2 Keyboard & PS/2 Mouse Connector	P.17
CPU Fan	P.18
System Fan	P.18
ATX Power	P.19
Floppy Port	P.19
IDE 1(Primary) / IDE 2(Secondary) Port	P.20
J1 (Wake On LAN)	P.20
J4 (IR)	P.21
J5 (AUX_IN)	P.21
J8 (CD Audio Line In)[Optional]	P.22
Panel and Jumper Definition	P.23
J2 (2x11 Pins Jumper)	P.23
BAT1(Battery)	P.24

CPU Speed Setup

The system bus speed is selectable at 66,100,133MHz and Auto. The user can select the system bus speed (**SW1**) and change the DIP switch (**SW2**) selection to set up the CPU speed for 500 – 1G Hz processor.

Set System Bus Speed

SW1:

O : ON, X : OFF

CPU (MHz)	1	2	3	4	5	6	PCI(MHz)
Auto	X	X	X	X	O	O	33.3
66	O	O	X	X	X	X	33.3
75	O	O	O	X	X	X	37.5
83	O	O	X	O	X	X	41.6
100	O	X	X	X	X	X	33.3
112	O	X	O	X	X	X	37.3
124	X	X	X	O	X	X	31
133	X	X	X	X	X	X	33.3
140	X	X	O	O	X	X	35
150	X	X	O	X	X	X	37.5

The CPU speed must match with the frequency ratio. It will cause system hanging up if the frequency ratio is higher than that of CPU.

SW2:

FREQ. RATIO	DIP SWITCH			
	1	2	3	4
X3	O	X	O	O
X3.5	X	X	O	O
X4	O	O	X	O
X4.5	X	O	X	O
X5	O	X	X	O
X5.5	X	X	X	O
X6	O	O	O	X
X6.5	X	O	O	X
X7	O	X	O	X
X7.5	X	X	O	X
X8	O	O	X	X
X8.5	O	X	O	O
X9	X	X	O	O
X9.5	X	O	O	O
X10	X	O	X	X
X10.5	O	O	X	O
X11	O	X	X	X
X11.5	X	O	X	O
X12	O	X	X	O

X13	X	X	X	O
X14	O	O	O	X
X15	X	O	O	X
X16	O	X	O	X

☛ For Auto Jumper Setting:

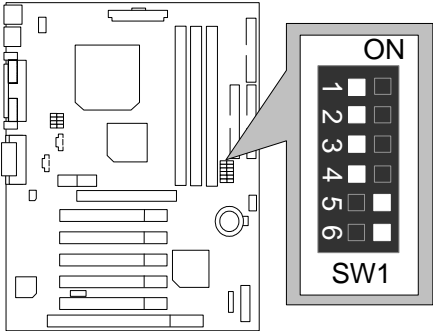

★Note:

- 1. If you use 66/100/133 MHz CPU, We recommend you to setup your system speed to "Auto" value.
- 2. We don't recommend you to set up your system speed to 75 , 83 , 112 , 124 , 140 ,150 MHz because these frequencies are not the standard specifications for CPU, Chipset and most of the peripherals. Whether your system can run under 75 ,83 ,112 ,124 ,140 ,150 MHz properly will depend on your hardware configurations: CPU, SDRAM, Cards, etc.

- 1. Celeron™ 533/ 66 MHz FSB

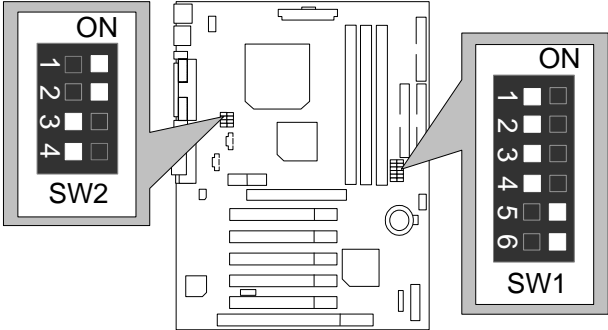

2. Celeron™ 566/ 66 MHz FSB

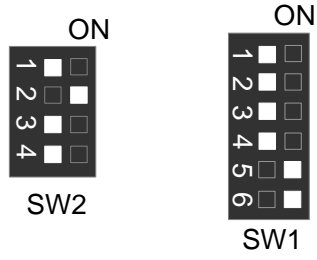

3. Celeron™ 600/ 66 MHz FSB

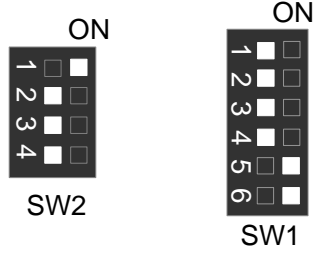

4. Celeron™ 633/ 66 MHz FSB

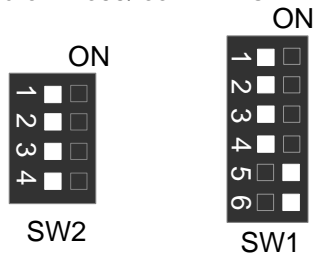

5. Celeron™ 667/ 66 MHz FSB

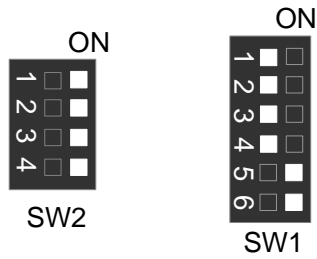

6. Celeron™ 700/ 66 MHz FSB

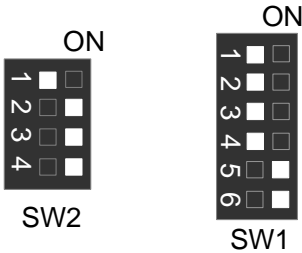

7. Cyrix® III 550/ 100MHz FSB (Optional)

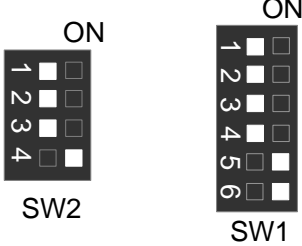

8. Cyrix® III 533 / 133 MHz FSB (Optional)

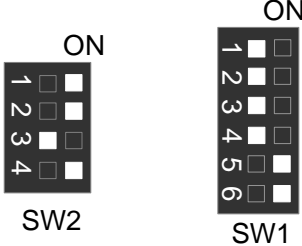

9. Cyrix® III 600/ 133 MHz FSB (Optional)

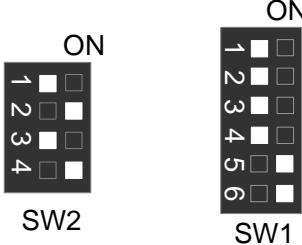

10. Cyrix® III 733/133MHz FSB

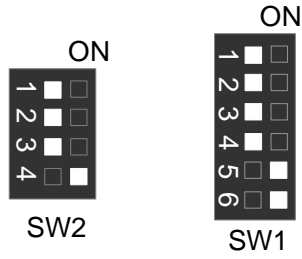

11. Cyrix® III 800/133MHz FSB

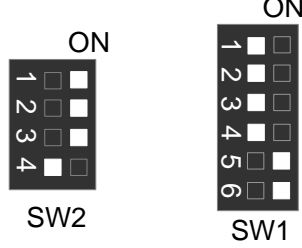

12. Pentium® III 500/100MHz FSB

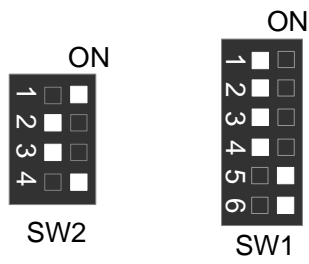

13. Pentium® III 550/100MHz FSB

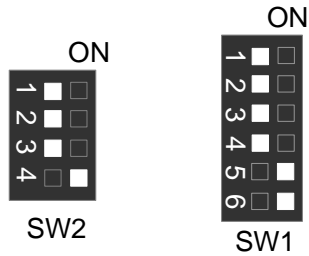

14. Pentium® !!! 600/100MHz FSB

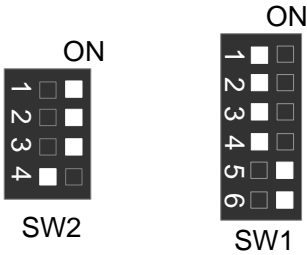

15. Pentium® !!! 650/100MHz FSB

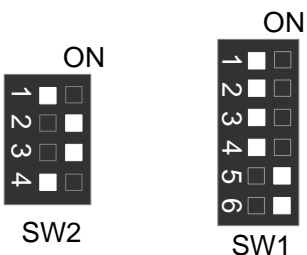

16. Pentium® !!! 700/100MHz FSB

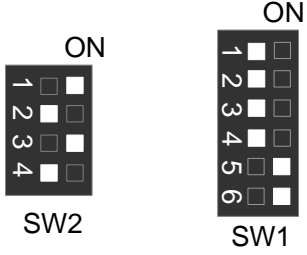

17. Pentium® !!! 750/100MHz FSB

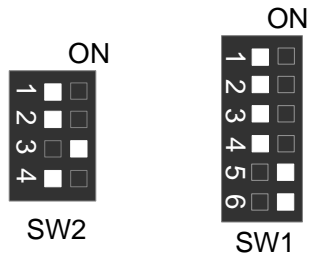

18. Pentium® !!! 800/100MHz FSB

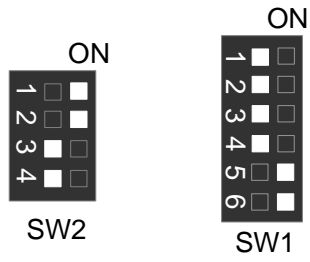

19. Pentium® !!! 850/100MHz FSB

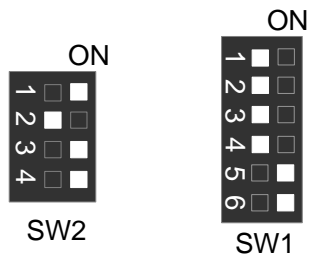

20. Pentium® !!! 533/133MHz FSB

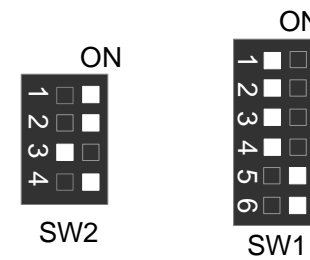

21. Pentium® !!! 600/133 MHz FSB

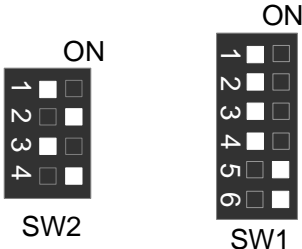

22. Pentium® !!! 667/133MHz FSB

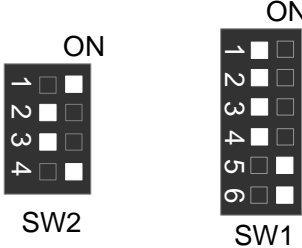

23. Pentium® !!! 733/133MHz FSB

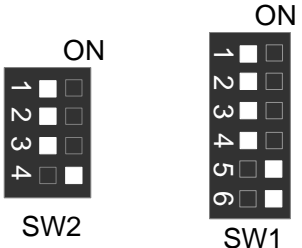

24. Pentium® !!! 800/133MHz FSB

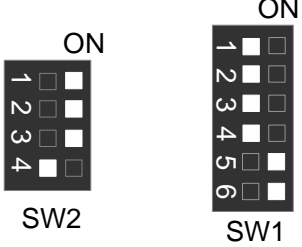

25. Pentium® !!! 866/133MHz FSB

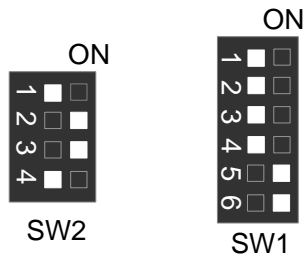

26. Pentium® !!! 933/133MHz FSB

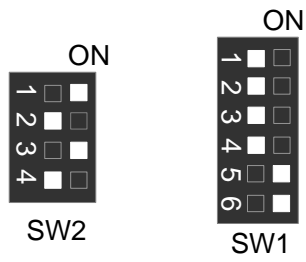

27. Pentium® !!! 1G Hz /133MHz FSB

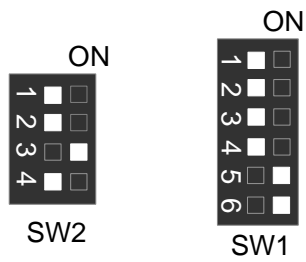

Connectors

COM A / COM B / LPT Port

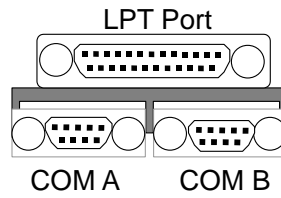
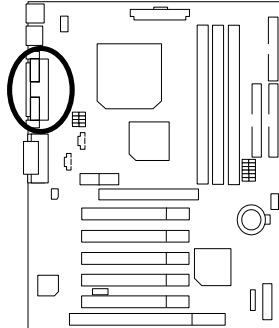

Game & Audio Port

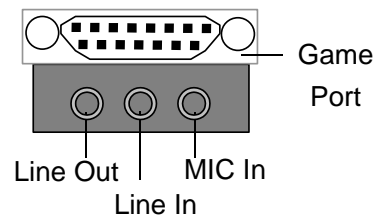
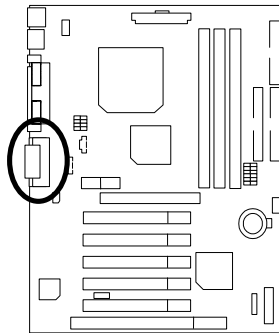

USB Connector

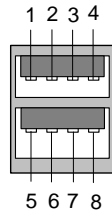
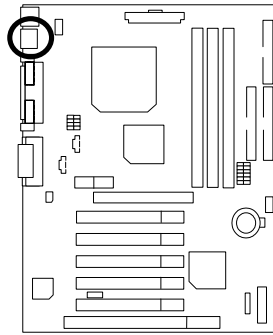

Pin No.	Definition
1	USB V0
2	USB D0-
3	USB D0+
4	GND
5	USB V1
6	USB D1-
7	USB D1+
8	GND

PS/2 Keyboard & PS/2 Mouse Connector

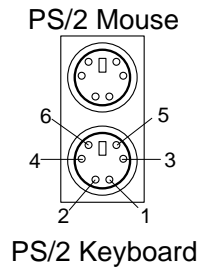
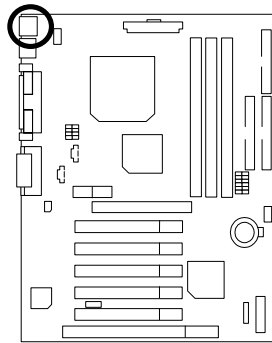

PS/2 Mouse/Keyboard	
Pin No.	Definition
1	Data
2	NC
3	GND
4	VCC(+5V)
5	Clock
6	NC

CPU_FAN: CPU Fan

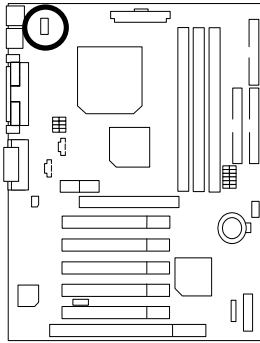

Pin No.	Definition
1	Control
2	+12V
3	SENSE

SYS_FAN: System Fan

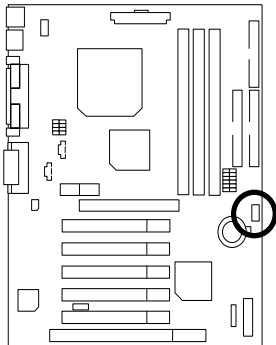

Pin No.	Definition
1	Control
2	+12V
3	SENSE

ATX Power

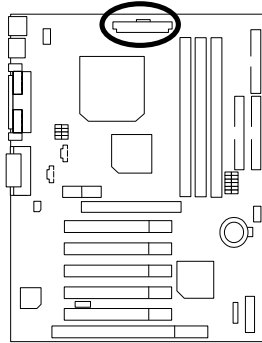

20																				11	
10																					1

Pin No.	Definition
3,5,7,13,15-17	GND
1,2,11	3.3V
4,6,19,20	VCC
10	+12V
12	-12V
18	-5V
8	Power Good
9	5V SB stand by+5V
14	PS-ON(Soft On/Off)

Floppy Port

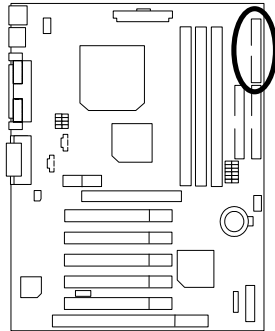

Red Line



FDD1

IDE1(Primary), IDE2(Secondary) Port

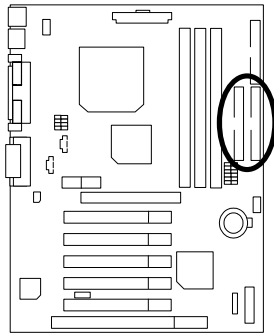

Red Line

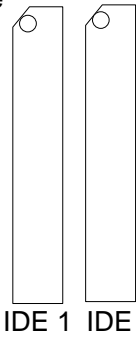

J1: Wake On LAN

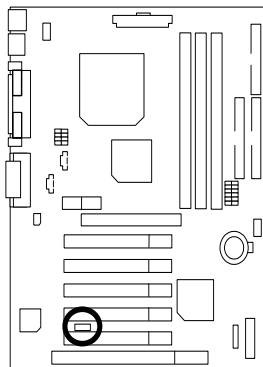

Pin No.	Definition
1	+5V SB
2	GND
3	Signal

J4 : IR

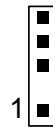
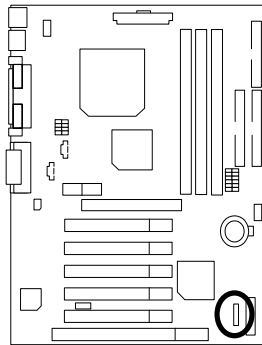

Pin No.	Definition
1	VCC (+5V)
2	NC
3	IR Data Input
4	GND
5	IR Data Output

J5: AUX_IN

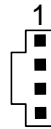
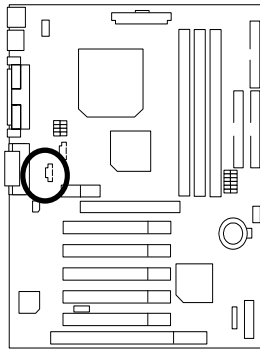

Pin No.	Definition
1	AUX-L
2	GND
3	GND
4	AUX-R

J8: CD Audio Line In

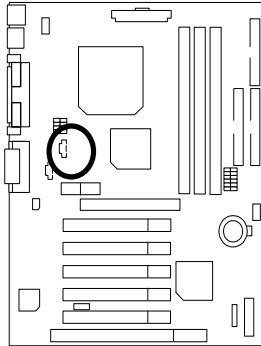

Pin No.	Definition
1	CD-L
2	GND
3	GND
4	CD-R

Panel and Jumper Definition

J2 : 2x11 Pins Jumper

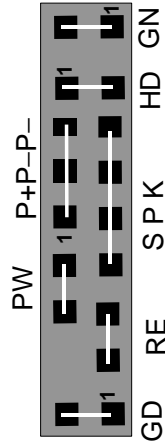
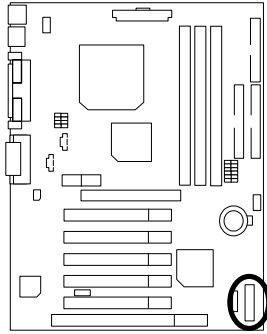

GN (Green Switch)	Open: Normal Operation Close: Entering Green Mode
GD (Green LED)	Pin 1: LED anode(+) Pin 2: LED cathode(-)
HD (IDE Hard Disk Active LED)	Pin 1: LED anode(+) Pin 2: LED cathode(-)
SPK (Speaker Connector)	Pin 1: VCC(+) Pin 2- Pin 3: NC Pin 4: Data(-)
RE (Reset Switch)	Open: Normal Operation Close: Reset Hardware System
P+P-P-(Power LED)	Pin 1: LED anode(+) Pin 2: LED cathode(-) Pin 3: LED cathode(-)
PW (Soft Power Connector)	Open: Normal Operation Close: Power On/Off

BAT1 : Battery

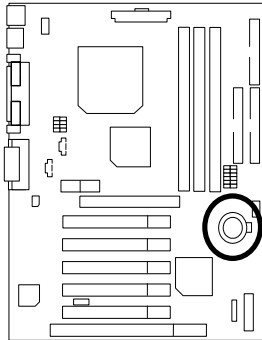

- ☞ Danger of explosion if battery is incorrectly replaced.
- ☞ Replace only with the same or equivalent type recommended by the manufacturer.
- ☞ Dispose of used batteries according to the manufacturer's instructions.

Block Diagram

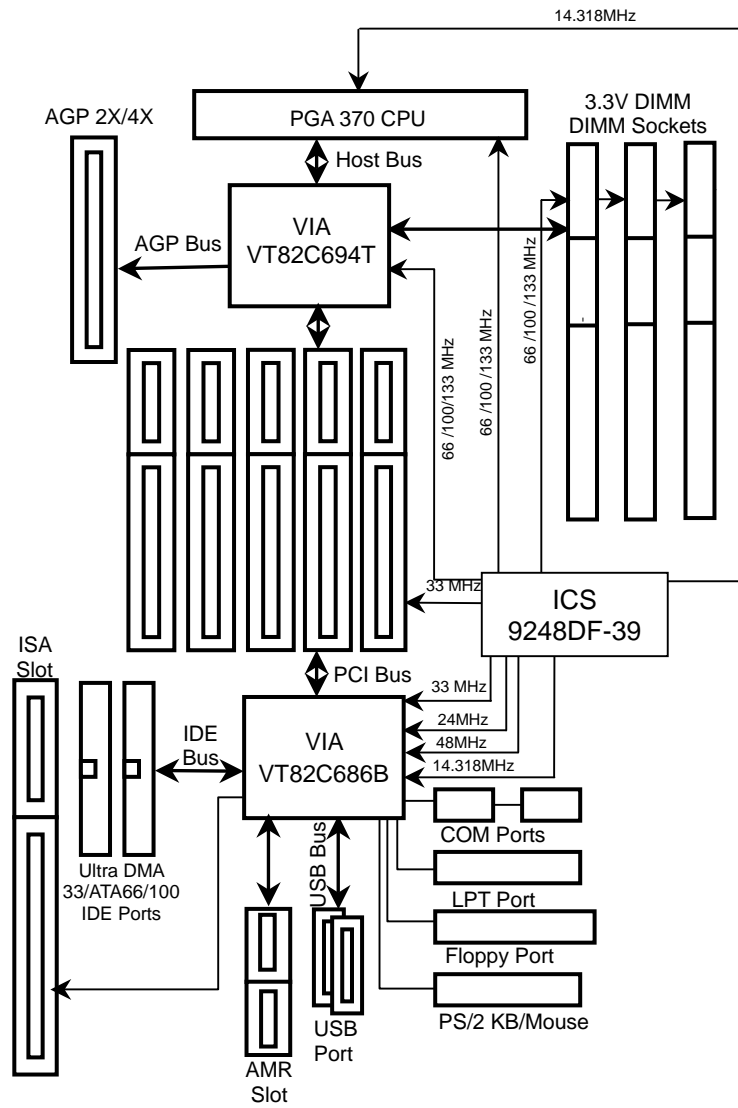

Memory Installation

The motherboard has 3 dual inline memory module (DIMM) sockets. The BIOS will automatically detects memory type and size. To install the memory module, just push it vertically into the DIMM Slot .The DIMM module can only fit in one direction due to the two notch. Memory size can vary between sockets.

Install memory in any combination table:

DIMM	168-pin SDRAM DIMM Modules	
DIMM 1	Supports 16 / 32 / 64 / 128 / 256 / 512 MB	X 1 pcs
DIMM 2	Supports 16 / 32 / 64 / 128 / 256 / 512 MB	X 1 pcs
DIMM 3	Supports 16 / 32 / 64 / 128 / 256 / 512 MB	X 1 pcs

★Total System Memory (Max 1.5GB)

6VTXE(-A) Motherboard

 Page Index for BIOS Setup	Page
The Main Menu	P.29
Standard CMOS Setup	P.31
BIOS Features Setup	P.34
Chipset Features Setup	P.36
Power Management Setup	P.39
PNP/ PCI Configuration	P.42
Load FAIL-SAFE Defaults	P.44
Load Optimized Defaults	P.45
Integrated Peripherals	P.46
Hardware Monitor & MISC Setup	P.50
Supervisor Password / User Password	P.52
IDE HDD Auto Detection	P.53
Save & Exit Setup	P.54
Exit Without Saving	P.55

BIOS Setup

BIOS Setup is an overview of the BIOS Setup Program. The program that allows users to modify the basic system configuration. This type of information is stored in battery-backed CMOS RAM so that it retains the Setup information when the power is turned off.

ENTERING SETUP

Power ON the computer and press immediately will allow you to enter Setup. If the message disappears before you respond and you still wish to enter Setup, restart the system to try again by turning it OFF then ON or pressing the "RESET" bottom on the system case. You may also restart by simultaneously press <Ctrl> – <Alt>– keys.

CONTROL KEYS

<↑>	Move to previous item
<↓>	Move to next item
<←>	Move to the item in the left hand
<→>	Move to the item in the right hand
<Esc>	Main Menu - Quit and not save changes into CMOS Status Page Setup Menu and Option Page Setup Menu - Exit current page and return to Main Menu
<+/PgUp>	Increase the numeric value or make changes
<-/PgDn>	Decrease the numeric value or make changes
<F1>	General help, only for Status Page Setup Menu and Option Page Setup Menu
<F2>	Reserved
<F3>	Reserved
<F4>	Reserved
<F5>	Restore the previous CMOS value from CMOS, only for Option Page Setup Menu
<F6>	Load the default CMOS value from BIOS default table, only for Option Page Setup Menu
<F7>	Load the Setup Defaults.
<F8>	Flash Utility
<F9>	Reserved
<F10>	Save all the CMOS changes, only for Main Menu

GETTING HELP

Main Menu

The on-line description of the highlighted setup function is displayed at the bottom of the screen.

Status Page Setup Menu / Option Page Setup Menu

Press F1 to pop up a small help window that describes the appropriate keys to use and the possible selections for the highlighted item. To exit the Help Window press <Esc>.

The Main Menu

Once you enter AMI BIOS CMOS Setup Utility, the Main Menu (Figure 1) will appear on the screen. The Main Menu allows you to select from nine setup functions and two exit choices. Use arrow keys to select among the items and press <Enter> to accept or enter the sub-menu.

AMIBIOS SIMPLE SETUP UTILITY-VERSION 1.24h (C) 1999 American Megatrends, Inc. All Rights Reserved	
STANDARD CMOS SETUP	INTEGRATED PERIPHERALS
BIOS FEATURES SETUP	HARDWARE MONITOR & MISC SETUP
CHIPSET FEATURES SETUP	SUPERVISOR PASSWORD
POWER MANAGEMENT SETUP	USER PASSWORD
PNP/PCI CONFIGURATION	IDE HDD AUTO DETECTION
LOAD Fail-Safe DEFAULTS	SAVE & EXIT SETUP
LOAD Optimized DEFAULTS	EXIT WITHOUT SAVING
ESC : Quit ↑↓←→ : Select Item (Shift) F2 : Change Color F5 : Old Values F6 : Load Fail-Safe Defaults F7: Load Optimized Defaults F8:Flash Utility F10: Save & Exit	
Time, Date, Hard Disk Type, ...	

Figure 1: Main Menu

- **Standard CMOS Setup**
This setup page includes all the items in standard compatible BIOS.
- **BIOS Features Setup**
This setup page includes all the items of AMI special enhanced features.

- **Chipset Features Setup**

This setup page includes all the items of chipset special features.
- **Power Management Setup**

This setup page includes all the items of Green function features.
- **PnP/PCI Configurations**

This setup page includes all the configurations of PCI & PnP ISA resources.
- **Load Fail-Safe Defaults**

Fail-Safe Defaults indicates the value of the system parameter which the system would be in the safe configuration.
- **Load Optimized Defaults**

Optimized Defaults indicates the value of the system parameter which the system would be in the most appropriate configuration.
- **Integrated Peripherals**

This setup page includes all onboard peripherals.
- **Hardware Monitor & MISC Setup**

This setup page is auto detect fan and temperature status.
- **Supervisor password**

Change, set, or disable password. It allows you to limit access to the system and Setup, or just to Setup.
- **User password**

Change, set, or disable password. It allows you to limit access to the system.
- **IDE HDD auto detection**

Automatically configure hard disk parameters.
- **Save & Exit Setup**

Save CMOS value settings to CMOS and exit setup.
- **Exit Without Saving**

Abandon all CMOS value changes and exit setup.

Standard CMOS Setup

The items in Standard CMOS Features Menu (Figure 2) are divided into 9 categories. Each category includes no, one or more than one setup items. Use the arrows to highlight the item and then use the <PgUp> or <PgDn> keys to select the value you want in each item.

AMIBIOS SETUP – STANDARD CMOS SETUP (C) 1999 American Megatrends, Inc. All Rights Reserved	
Date (mm/dd/yyyy) : Tue Jan 25, 2000 Time (hh/mm/ss) : 10:36:24	
TYPE SIZE CYLS HEAD PRECOMP LANDZ SECTOR MODE	
Pri Master : Auto Pri Slave : Auto Sec Master : Auto Sec Slave : Auto	
Floppy Drive A: 1.44 MB 3 ½ Floppy Drive B: Not Installed	Base Memory : 640 Kb Other Memory: 384 Kb Extended Memory: 30Mb Total Memory: 31Mb
Boot Sector Virus Protection : Disabled	
Month: Jan – Dec Day: 01 – 31 Year: 1990– 2099	ESC : Exit ↑↓ : Select Item PU/PD/+/- : Modify (Shift)F2 : Color

Figure 2: Standard CMOS Setup

- **Date**

The date format is <Week>, <Month>, <Day>, <Year>.

Week	The week, from Sun to Sat, determined by the BIOS and is display-only
Month	The month, Jan. Through Dec.
Day	The day, from 1 to 31 (or the maximum allowed in the month)
Year	The year, from 1990 through 2099

- **Time**

The times format in <hour> <minute> <second>. The time is calculated base on the 24-hour military-time clock. For example, 1 p.m. is 13:00:00.

- **IDE Primary Master, Slave / Secondary Master, Slave**

The category identifies the types of hard disk from drive C to F that has been installed in the computer. There are two types: auto type, and user definable type. User type is user-definable; Auto type which will automatically detect HDD type.

Note that the specifications of your drive must match with the drive table. The hard disk will not work properly if you enter improper information for this category.

If you select User Type, related information will be asked to enter to the following items. Enter the information directly from the keyboard and press <Enter>. Such information should be provided in the documentation form your hard disk vendor or the system manufacturer.

CYLS.	Number of cylinders
HEADS	number of heads
PRECOMP	write precomp
LANDZONE	Landing zone
SECTORS	number of sectors

If a hard disk has not been installed select NONE and press <Enter>.

- **Drive A type / Drive B type**

The category identifies the types of floppy disk drive A or drive B that has been installed in the computer.

None	No floppy drive installed
360K, 5.25 in.	5.25 inch PC-type standard drive; 360K byte capacity.
1.2M, 5.25 in.	5.25 inch AT-type high-density drive; 1.2M byte capacity (3.5 inch when 3 Mode is Enabled).
720K, 3.5 in.	3.5 inch double-sided drive; 720K byte capacity
1.44M, 3.5 in.	3.5 inch double-sided drive; 1.44M byte capacity.
2.88M, 3.5 in.	3.5 inch double-sided drive; 2.88M byte capacity.

- **Boot Sector Virus Protection**

If it is set to enable, the category will flash on the screen when there is any attempt to write to the boot sector or partition table of the hard disk drive. The system will halt and the following error message will appear in the mean time. You can run anti-virus program to locate the problem.

Enabled	Activate automatically when the system boots up causing a warning message to appear when anything attempts to access the boot sector or hard disk partition table
Disabled	No warning message to appear when anything attempts to access the boot sector or hard disk partition table. (Default Value)

- **Memory**

The category is display-only which is determined by POST (Power On Self Test) of the BIOS.

Base Memory

The POST of the BIOS will determine the amount of base (or conventional) memory installed in the system.

The value of the base memory is typically 512 K for systems with 512 K memory installed on the motherboard, or 640 K for systems with 640 K or more memory installed on the motherboard.

Extended Memory

The BIOS determines how much extended memory is present during the POST.

This is the amount of memory located above 1 MB in the CPU's memory address map.

Other Memory

This refers to the memory located in the 640 K to 1024 K address space. This is memory that can be used for different applications.

DOS uses this area to load device drivers to keep as much base memory free for application programs. Most use for this area is Shadow RAM

- **S.M.A.R.T. for Hard Disks**

Enable	Enable S.M.A.R.T. Hard for Disks.
Disable	Disable S.M.A.R.T. Hard for Disks. (Default Value)

- **Interrupt Mode**

APIC	Through IOAPIC generate more IRQ for system use. (Default value)
PIC	Use AT standard IRQ controllers to generate IRQ.

When you already have IOAPIC enable system and want to upgrade the system please note, since running an IOAPIC enabled OS (like Windows NT, Windows 2000, Windows XP...) system with none IOAPIC HW support will cause the system to hang. Following are some situations users might run into: 1. An IOAPIC enabled OS and change the BIOS setting from IOAPIC to PIC, this will cause your system to hang.

- **Boot Up Num-Lock**

On	Keypad is number keys. (Default Value)
Off	Keypad is arrow keys.

- **Floppy Drive Seek**

During POST, BIOS will determine if the floppy disk drive installed is 40 or 80 tracks. 360 type is 40 tracks while 720, 1.2 and 1.44 are all 80 tracks.

Enabled	BIOS searches for floppy disk drive to determine if it is 40 or 80 tracks. Note that BIOS can not tell from 720, 1.2 or 1.44 drive type as they are all 80 tracks.
Disabled	BIOS will not search for the type of floppy disk drive by track number. Note that there will not be any warning message if the drive installed is 360. (Default Value)

- **Password Check**

Setup	Set Password Check to Setup. (Default Value)
Always	Set Password Check to Always.

- **Processor Serial Number**

Disabled	Disabled CPU Serial Number. (Default Value)
Enabled	Enabled CPU Serial Number.

Chipset Features Setup

AMIBIOS SETUP –CHIPSET FEATURE CMOS SETUP (C) 1999 American Megatrends, Inc. All Rights Reserved	
*** DRAM Timing ***	
Top Performance	:Disabled
SDRAM Timing by SPD	:Disabled
SDRAM CAS# Latency	:3
DRAM Frequency	:Auto
C2P Concurrency & Master	:Enabled
DRAM Integrity Mode	:Disabled
AGP Mode	:4X
AGP Comp. Driving	:Auto
AGP Aperture Size	:64MB
USB Controller	:Enabled
USB Legacy Support	:Disabled
DRAM Drive Strength	:Auto
Delay DRAM Read Latch	:1.5ns
Memory Data Drive	:6Ma
SDRAM Command Drive	:24MA
Memory Address Drive	:24MA
CAS# Drive	:12Ma
RAS# Drive	:24mA
ESC : Quit	↑↓←→: Select Item
F1: Help	PU/PD/+/- : Modify
F5: Old Values	(Shift)F2 :Color
F6: Load Fail-Safe Defaults	F8:Flash Utility
F7: Load Optimized Defaults	

Figure 4: Chipset Features Setup

- **Top Performance**

Disabled	Set Top Performance is disabled. (Default Value)
Enabled	Set Top Performance is enabled.

- **SDRAM Timing by SPD**

Disabled	SDRAM Timing by SPD Function Disabled. (Default Value)
Enabled	SDRAM Timing by SPD Function Enabled.

- **SDRAM CAS# Latency**

3	For Slower SDRAM DIMM module. (Default Value)
2	For Fastest SDRAM DIMM module.

- **DRAM Frequency**

Auto	Set DRAM Frequency automation. (Default Value)
100MHz	Set DRAM Frequency is 100MHz.
66MHz	Set DRAM Frequency is 66MHz.
133MHz	Set DRAM Frequency is 133MHz.

- **C2P Concurrency & Master**

Enabled	Enabled C2P Concurrency & Master. (Default Value)
Disabled	Disabled C2P Concurrency & Master.

- **DRAM Integrity Mode**

ECC	For 72 bit ECC type DIMM Model.
Disabled	Normal Setting. (Default Value)

- **AGP Mode**

4X	Set AGP Mode is 4X. (Default Value)
1X	Set AGP Mode is 1X.
2X	Set AGP Mode is 2X.

- **AGP Comp. Driving**

Auto	Set AGP Comp. Driving is Auto. (Default Value)
Manual	Set AGP Comp. Driving is Manual.

- **AGP Aperture Size**

4MB	Set AGP Aperture Size to 4MB.
8MB	Set AGP Aperture Size to 8 MB.
16MB	Set AGP Aperture Size to 16 MB.
32MB	Set AGP Aperture Size to 32 MB.
64MB	Set AGP Aperture Size to 64 MB. (Default Value)
128MB	Set AGP Aperture Size to 128 MB.
256MB	Set AGP Aperture Size to 256 MB.

- **USB Controller**

Enabled	USB Controller Function Enabled. (Default Value)
Disabled	USB Controller Function Disabled.

- **USB Legacy Support**

Keyboard	Set USB Legacy Support Keyboard.
Keyb+Mouse	Set USB Legacy Support Keyboard +Mouse.
Disabled	Disabled USB Legacy Support Function. (Default Value)

- **DRAM Drive Strength**

Auto	Set DRAM Drive Strength by auto. (Default Value)
Manual	Set DRAM Drive Strength by manual.

- **Memory Data Drive**

6 mA	Set Memory Data Drive to 6Ma. (Default Value)
8 Ma	Set Memory Data Drive to 8Ma.

- **SDRAM Command Drive**

24 mA	Set SDRAM Command Drive to 24Ma. (Default Value)
16 Ma	Set SDRAM Command Drive to 16Ma.

- **Memory Address Drive**

24 mA	Set Memory Address Drive to 24Ma. (Default Value)
16 Ma	Set Memory Address Drive to 16Ma.

- **CAS# Drive**

12 mA	Set CAS# Drive to 12Ma. (Default Value)
8 Ma	Set CAS# Drive to 8Ma.

- **RAS# Drive**

24 mA	Set RAS# Drive to 24Ma. (Default Value)
16 Ma	Set RAS# Drive to 16Ma.

Power Management Setup

AMIBIOS SETUP –POWER MANAGEMENT SETUP (C) 1999 American Megatrends, Inc. All Rights Reserved			
Video Power Down Mode	:Stand By	RTC Alarm Power On	:Disabled
Hard Disk Power Down Mode	:Stand by	RTC Alarm Date	:15
Suspend Time Out(Minute)	:Disabled	RTC Alarm Hour	:12
Display Activity	:Ignore	RTC Alarm Minute	:30
IRQ3	:Monitor	RTC Alarm Second	:30
IRQ 4	:Monitor		
IRQ 5	:Ignore		
IRQ 7	:Monitor		
IRQ 9	:Ignore		
IRQ 10	:Ignore		
IRQ 11	:Ignore		
IRQ 13	:Ignore		
IRQ 14	:Monitor		
IRQ 15	:Ignore		
Soft-off by Power Button	:Instant off		
AC Back Function	:Soft-off	ESC : Quit	↑↓←→: Select Item
Modem Use IRQ	:4	F1: Help	PU/PD/+/- : Modify
Modem Ring On/Wake On Lan	:Enabled	F5: Old Values	(Shift)F2 :Color
PME Event Wake up	:Enabled	F6: Load Fail-Safe Defaults	F8: Flash Utility
AMR Event Wake up	:Enabled	F7: Load Optimized Defaults	

Figure 5: Power Management Setup

- **Video Power Down Mode**

Disabled	Disabled Video Power Down Mode Function.
Suspend	Set Video Power Down Mode to Suspend.
Stand By	Set Video Power Down Mode to Stand By. (Default Value)

- **Hard Disk Power Down Mode**

Disabled	Disabled Hard Disk Power Down Mode Function.
Suspend	Set Hard Disk Power Down Mode to Suspend.
Stand By	Set Hard Disk Power Down Mode to Stand By. (Default Value)

- **Suspend Time Out (Minute.)**

Disabled	Disabled Suspend Time Out Function. (Default Value)
1	Enabled Suspend Time Out after 1min.
2	Enabled Suspend Time Out after 2min.
4	Enabled Suspend Time Out after 4min.
8	Enabled Suspend Time Out after 8min.
10	Enabled Suspend Time Out after 10min.
20	Enabled Suspend Time Out after 20min.
30	Enabled Suspend Time Out after 30min.
40	Enabled Suspend Time Out after 40min.
50	Enabled Suspend Time Out after 50min.
60	Enabled Suspend Time Out after 60min.

- **Display Activity**

Ignore	Ignore Display Activity. (Default Value)
Monitor	Monitor Display Activity.

- **IRQ 3-IRQ15**

Ignore	Ignore IRQ3 -IRQ15.
Monitor	Monitor IRQ3-IRQ15.

- **Soft-off by Power Button**

Instant off	Soft switch ON/OFF for Power Button. (Default Value)
Delay-4Sec	Soft switch ON 4 Sec for Power off.

- **AC Back Function**

Soft-Off	Set Restore on AC/Power Loss is Soft off. (Default Value)
Full-On	Set Restore on AC/Power Loss is Full on.
Memory	Set Restore on AC/Power Loss is Last state mode.

- **MODEM Use IRQ**

NA	Set MODEM Use IRQ to NA.
3	Set MODEM Use IRQ to 3.
4	Set MODEM Use IRQ to 4. (Default Value)
5	Set MODEM Use IRQ to 5.
7	Set MODEM Use IRQ to 7.

- **Modem Ring On / Wake On Lan**

Disabled	Disabled Modem Ring On / Wake On Lan function.
Enabled	Enabled Modem Ring On / Wake On Lan function. (Default Value)

- **PME Event Wake up**

Disabled	Disabled PME Event Wake up function.
Enabled	Enabled PME Event Wake up function. (Default Value)

- **AMR Event Wake up**

Disabled	Disabled AMR Event Wake up function.
Enabled	Enabled AMR Event Wake up function. (Default Value)

- **RTC Alarm Power On**

You can set "RTC Alarm Power On" item to enabled and key in Data/time to power on system.

Disabled	Disable this function. (Default Value)
Enabled	Enable alarm function to POWER ON system.

If RTC Alarm Lead To Power On is Enabled.

RTC Alarm Date :	Every Day,1~31
RTC Alarm Hour:	0~23
RTC Alarm Minute :	0~59
RTC Alarm Second :	0~59

PnP/PCI Configurations

AMIBIOS SETUP –PNP/PCI CONFIGURATION SETUP (C) 1999 American Megatrends, Inc. All Rights Reserved			
Plug and Play Aware O/S	:No	IRQ 10	:PCI/PnP
Reset Configuration Data	:No	IRQ 11	:PCI/PnP
VGA Boot From	:AGP	IRQ 14	:PCI/PnP
PCI VGA Palette Snoop	:Disabled	IRQ 15	:PCI/PnP
PCI IDE BusMaster	:Enabled		
PCI Slot 1/5 IRQ	:Auto		
PCI Slot 2	:Auto		
PCI Slot 3	:Auto		
PCI Slot 4	:Auto		
DMA Channel 0	:PnP		
DMA Channel 1	:PnP		
DMA Channel 3	:PnP		
DMA Channel 5	:PnP		
DMA Channel 6	:PnP		
DMA Channel 7	:PnP		
IRQ 3	:PCI/PnP	ESC : Quit	↑↓←→: Select Item
IRQ 4	:PCI/PnP	F1 : Help	PU/PD/+/- : Modify
IRQ 5	:PCI/PnP	F5 : Old Values	(Shift)F2 :Color
IRQ 7	:PCI/PnP	F6 : Load Fail-Safe Defaults	F8: Flash Utility
IRQ 9	:PCI/PnP	F7 : Load Optimized Defaults	

Figure 6: PnP/PCI Configuration

- **Plug and Play Aware O/S**

Yes	Enable Plug and Play Aware O/S function.
No	Disable Plug and Play Aware O/S function (Default Value)

- **Reset Configuration Data**

Yes	Reset configuration data.
No	Disabled this function. (Default Value)

- **VGA Boot From**

AGP	Primary Graphics Adapter From Add-on AGP. (Default Value)
PCI	Primary Graphics Adapter From OnBoard PCI.

- **PCI VGA Palette Snoop**

Enabled	For having Video Card on ISA Bus and VGA Card on PCI Bus.
Disabled	For VGA Card only. (Default Value)

● **PCI IDE BusMaster**

Enabled	Enabled PCI IDE Bus Master. (Default Value)
Disabled	Disabled PCI IDE Bus Master

● **PCI Slot 1/ 5 IRQ**

Auto	Auto assign IRQ to PCI 1/ PCI 5. (Default value)
3,4,5,7,9,10,11,12,15	Set 3,4,5,7,9,10,11,12,15 to PCI1/ PCI5.

● **PCI Slot 2 IRQ**

Auto	Auto assign IRQ to PCI 2/ PCI 6. (Default value)
3,4,5,7,9,10,11,12,15	Set 3,4,5,7,9,10,11,12,15 to PCI2/ PCI6.

● **PCI Slot 3 IRQ**

Auto	Auto assign IRQ to PCI 3. (Default value)
3,4,5,7,9,10,11,12,15	Set 3,4,5,7,9,10,11,12,15 to PCI3.

● **PCI Slot 4 IRQ**

Auto	Auto assign IRQ to PCI 4. (Default value)
3,4,5,7,9,10,11,12,15	Set 3,4,5,7,9,10,11,12,15 to PCI4.

● **DMA Channel (0,1,3,5,6,7)**

PnP	The resource is used by PnP device.
ISA/ EISA	The resource is used by ISA/ EISA device (PCI or ISA).

● **IRQ (3,4,5,7, 9,10,11,14,15)**

PCI/PnP	The resource is used by PCI/PnP device.
ISA/ EISA	The resource is used by ISA/ EISA device (PCI or ISA).

Load Fail-Safe Defaults

AMIBIOS SIMPLE SETUP UTILITY-VERSION 1.24h (C) 1999 American Megatrends, Inc. All Rights Reserved	
STANDARD CMOS SETUP	INTEGRATED PERIPHERALS
BIOS FEATURES SETUP	HARDWARE MONITOR & MISC SETUP
CHIPSET FEATURES SETUP	SUPERVISOR PASSWORD
POWER MANAGEMENT SETUP	USER PASSWORD
PNP/PCI CONFIGURATION	LOAD Fail-Safe Defaults (Y/N)? N
LOAD Fail-Safe Defaults	SAVE & EXIT SETUP
LOAD Optimized Defaults	EXIT WITHOUT SAVING
ESC : Quit ↑↓←→ : Select Item (Shift) F2 : Change Color F5 : Old Values F6 : Load Fail-Safe Defaults F7: Load Optimized Defaults F8:Flash Utility F10: Save & Exit	
Load BIOS Default except Standard CMOS Setup	

Figure 7: Load Fail-Safe Defaults

- **Load Fail-Safe Defaults**

Fail-Safe defaults contain the most appropriate values of the system parameters that allow minimum system performance.

Load Optimized Defaults

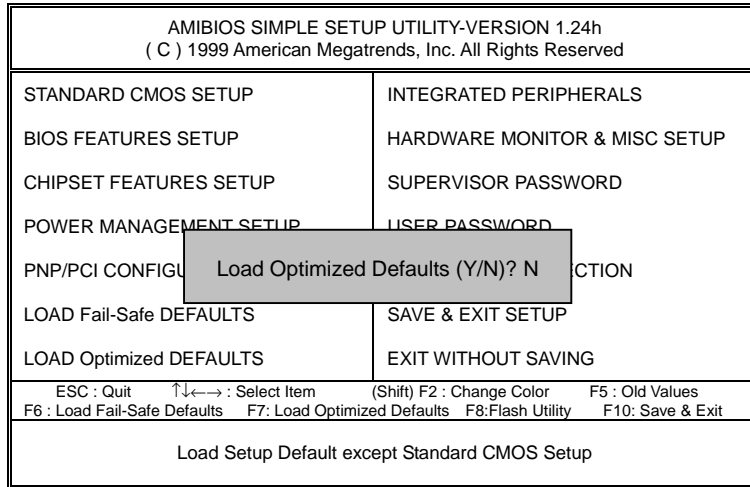

Figure 8: Load Optimized Defaults

- **Load Optimized Defaults**

Selecting this field loads the factory defaults for BIOS and Chipset Features which the system automatically detects.

Integrated Peripherals

AMIBIOS SETUP –INTEGRATED PERIPHERAL (C) 1999 American Megatrends, Inc. All Rights Reserved			
Enhance ATAPI Performance	:Disabled	MPU-401	:Disabled
OnBoard IDE	:Both	MPU-401 I/O Address	:330h-333h
IDE1 Conductor Cable	:Auto	FM Port (388h-38Bh)	:Disabled
IDE2 Conductor Cable	:Auto	Game Port (200h-207h)	:Enabled
OnBoard FDC	:Auto		
OnBoard Serial Port 1	:Auto		
OnBoard Serial Port 2	:Auto		
Serial Port 2 Mode	:Normal		
Duplex Mode	:N/A		
OnBoard Parallel Port	:Auto		
Parallel Port Mode	:ECP		
Parallel Port DMA	:Auto		
Parallel Port IRQ	:Auto		
OnBoard AC'97 Audio	:Auto		
OnBoard MC'97 Modem	:Auto		
OnBoard Legacy Audio	:Enabled	ESC : Quit	↑↓←→: Select Item
Sound Blaster	:Disabled	F1: Help	PU/PD/+/- : Modify
SB I/O Base Address	:220h-22fh	F5: Old Values	(Shift)F2 :Color
SB IRQ Select	:IRQ5	F6: Load Fail-Safe Defaults	F8:Flash Utility
SB DMA Select	:DMA1	F7: Load Optimized Defaults	

Figure 9: Integrated Peripherals

- **Enhance ATAPI Performance**

Disabled	Disabled enhance ATAPI Performance. (Default Value) .
Enabled	Enabled enhance ATAPI Performance.

- **OnBoard IDE**

Disabled	Disabled OnBoard IDE
Both	Set OnBoard IDE is Both (Default Value) .
Primary	Set OnBoard IDE is Primary
Secondary	Set OnBoard IDE is Secondary

- **IDE1 Conductor Cable**

Auto	Will be automatically detected by BIOS (Default Value) .
ATA66/100	Set IDE1 Conductor Cable to ATA66/100 (Please make sure your IDE device and cable is compatible with ATA66/100)
ATA33	Set IDE1 Conductor Cable to ATA33 (Please make sure your IDE device and cable is compatible with ATA33).

- **IDE2 Conductor Cable**

Auto	Will be automatically detected by BIOS (Default Value) .
ATA66/100	Set IDE2 Conductor Cable to ATA66/100 (Please make sure your IDE device and cable is compatible with ATA66/100)
ATA33	Set IDE2 Conductor Cable to ATA33 (Please make sure your IDE device and cable is compatible with ATA33).

- **On Board FDC**

Auto	Set On Board FDC is Auto (Default Value) .
Disabled	Disabled On Board FDC
Enabled	Enabled On Board FDC

- **Onboard Serial Port 1**

Auto	BIOS will automatically setup the port 1 address (Default Value) .
3F8/COM1	Enable onboard Serial port 1 and address is 3F8.
2F8/COM2	Enable onboard Serial port 1 and address is 2F8.
3E8/COM3	Enable onboard Serial port 1 and address is 3E8.
2E8/COM4	Enable onboard Serial port 1 and address is 2E8.
Disabled	Disable onboard Serial port 1.

- **Onboard Serial Port 2**

Auto	BIOS will automatically setup the port 2 address (Default Value) .
3F8/COM1	Enable onboard Serial port 2 and address is 3F8.
2F8/COM2	Enable onboard Serial port 2 and address is 2F8.
3E8/COM3	Enable onboard Serial port 2 and address is 3E8.
2E8/COM4	Enable onboard Serial port 2 and address is 2E8.
Disabled	Disable onboard Serial port 2.

- **Serial Port 2 Mode**

ASKIR	Set onboard I/O chip Serial Port 2 to ASKIR Mode.
IrDA	Set onboard I/O chip Serial Port 2 to IrDA Mode.
Normal	Set onboard I/O chip Serial Port 2 to Normal Mode. (Default Value)

- **Duplex Mode**

Half Duplex	IR Function Duplex Half.
N/A	Disabled this function. (Default Value)
Full Duplex	IR Function Duplex Full.

- **On Board Parallel port**

378	Enable On Board LPT port and address is 378.
278	Enable On Board LPT port and address is 278.
3BC	Enable On Board LPT port and address is 3BC.
Auto	Set On Board LPT port is Auto. (Default Value) .
Disabled	Disable On Board LPT port.

- **Parallel Port Mode**

EPP	Using Parallel port as Enhanced Parallel Port.
ECP	Using Parallel port as Extended Capabilities Port. (Default Value)
Normal	Normal Operation.

- **Parallel Port DMA**

Auto	Set Auto to parallel port mode DMA Channel. (Default Value)
N/A	Disabled this function.
3	Set Parallel Port DMA is 3.
1	Set Parallel Port DMA is 1.
0	Set Parallel Port DMA is 0.

- **Parallel Port IRQ**

7	Set Parallel Port IRQ is 7.
Auto	Set Auto to parallel Port IRQ DMA Channel. . (Default Value) .
5	Set Parallel Port IRQ is 5.

- **OnBoard AC'97 Audio**

Auto	Set AC'97 Audio to Auto (Default Value) .
Disabled	Disabled AC'97 Audio.

- **OnBoard MC'97 Modem**

Auto	Set MC'97 Modem to Auto (Default Value) .
Disabled	Disabled MC'97 Modem.

- **OnBoard Legacy Audio**

Enabled	Enabled OnBoard Legacy Audio. (Default Value)
Disabled	Disabled OnBoard Legacy Audio.

- **Sound Blaster**

Enabled	Enabled Sound Blaster.
Disabled	Disabled Sound Blaster. (Default Value)

- **SB I/O Base Address**

220h-22Fh	Set SB I/O Base Address is 220h-22Fh. (Default Value)
280h-28Fh	Set SB I/O Base Address is 280h-28Fh.
260h-26Fh	Set SB I/O Base Address is 260h-26Fh.
240h-24Fh	Set SB I/O Base Address is 240h-24Fh.

- **SB IRQ Select**

IRQ 5 / 7 / 9 / 10. (Default Value: 5)

- **SB DMA Select**

DMA 0 / 1 / 2 / 3. (Default Value: 1)
--

- **MPU-401**

Enabled	Enabled MPU-401.
Disabled	Disabled MPU-401. (Default Value)

- **MUP-401 I/O Address**

330h-333h	Set MUP-401 I/O Address is 330h-333h. (Default Value)
300h-303h	Set MUP-401 I/O Address is 300h-303h.
310h-313h	Set MUP-401 I/O Address is 310h-313h.
320h-323h	Set MUP-401 I/O Address is 320h-323h.

- **FM Port (388h-38Bh)**

Disabled	Disabled FM Port (388h-38Bh). (Default Value)
Enabled	Enabled FM Port (388h-38Bh).

- **Game Port (200h-207h)**

Disabled	Disabled Game Port (200h-207h).
Enabled	Enabled Game Port (200h-207h). (Default Value)

- **Current CPU FAN Speed**
Detect CPU Fan speed status automatically .
- **Current System FAN Speed**
Detect System Fan speed status automatically .
- **Current Voltage (V) VCORE / +3.3V / +12V / +5V**
Detect system's voltage status automatically.

Set Supervisor / User Password

When you select this function, the following message will appear at the center of the screen to assist you in creating a password.

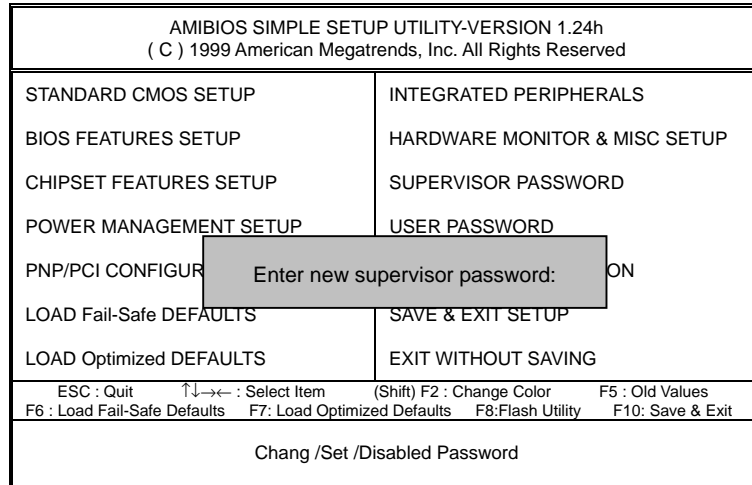

Figure 11: Password Setting

Type the password, up to six characters, and press <Enter>. The password typed now will clear the previously entered password from CMOS memory. You will be asked to confirm the password. Type the password again and press <Enter>. You may also press <Esc> to abort the selection and not enter a password.

To disable password, just press <Enter> when you are prompted to enter password. A message "PASSWORD DISABLED" will appear to confirm the password being disabled. Once the password is disabled, the system will boot and you can enter Setup freely.

If you select "Always" at "Password Check" Option in BIOS Features Setup Menu, you will be prompted for the password every time the system is rebooted or any time you try to enter Setup Menu. If you select "Setup" at "Password Check" Option in BIOS Features Setup Menu, you will be prompted only when you try to enter Setup.

IDE HDD AUTO Detection

AMBIOS SETUP – STANDARD CMOS SETUP (C) 1999 American Megatrends, Inc. All Rights Reserved							
Date (mm/dd/yyyy) : Tue Jan 25, 2000 Time (hh/mm/ss) : 10:36:24							
TYPE	SIZE	CYLS	HEAD	PRECOMP	LANDZ	SECTOR	MODE
Pri Master : Not Installed Pri Slave : Not Installed Sec Master : Not Installed Sec Slave : Not Installed							
Floppy Drive A: 1.44 MB 3 ½				Base Memory : 640 Kb			
Floppy Drive B: Not Installed				Other Memory: 384 Kb			
Boot Sector Virus Protection : Disabled				Extended Memory: 31Mb			
				Total Memory: 32Mb			
Month: Jan – Dec				ESC : Exit			
Day: 01 – 31				↑↓ : Select Item			
Year: 1990– 2099				PU/PD/+/- : Modify			
				(Shift)F2 : Color			

Figure 12: IDE HDD Auto Detection

Type "Y" will accept the H.D.D. parameter reported by BIOS.

Type "N" will keep the old H.D.D. parameter setup. If the hard disk cylinder number is over 1024, then the user can select LBA mode or LARGER mode for DOS partition larger than 528 MB.

Save & Exit Setup

AMIBIOS SIMPLE SETUP UTILITY-VERSION 1.24h (C) 1999 American Megatrends, Inc. All Rights Reserved	
STANDARD CMOS SETUP	INTEGRATED PERIPHERALS
BIOS FEATURES SETUP	HARDWARE MONITOR & MISC SETUP
CHIPSET FEATURES SETUP	SUPERVISOR PASSWORD
POWER MANAGEMENT SETUP	USER PASSWORD
PNP/PCI CONFIGURATION	
LOAD Fail-Safe Defaults	SAVE to CMOS and EXIT(Y/N)? Y
LOAD Optimized DEFAULTS	EXIT WITHOUT SAVING
ESC : Quit ↑↓←→ : Select Item (Shift) F2 : Change Color F5 : Old Values F6 : Load Fail-Safe Defaults F7: Load Optimized Defaults F8: Flash Utility F10: Save & Exit	
Save Data to CMOS & Exit Setup	

Figure 13: Save & Exit Setup

Type "Y" will quit the Setup Utility and save the user setup value to RTC CMOS.

Type "N" will return to Setup Utility.

Exit Without Saving

AMIBIOS SIMPLE SETUP UTILITY-VERSION 1.24h (C) 1999 American Megatrends, Inc. All Rights Reserved	
STANDARD CMOS SETUP	INTEGRATED PERIPHERALS
BIOS FEATURES SETUP	HARDWARE MONITOR & MISC SETUP
CHIPSET FEATURES SETUP	SUPERVISOR PASSWORD
POWER MANAGEMENT SETUP	USER PASSWORD
PNP/PCI CONFIGURATION	
LOAD Fail-Safe Defaults	Quit without saving (Y/N) ? N
LOAD Optimized DEFAULTS	EXIT WITHOUT SAVING
ESC : Quit ↑↓→← : Select Item (Shift) F2 : Change Color F5 : Old Values F6 : Load Fail-Safe Defaults F7: Load Optimized Defaults F8:Flash Utility F10: Save & Exit	
Abandon all Datas & Exit Setup	

Figure 14: Exit Without Saving

Type "Y" will quit the Setup Utility without saving to RTC CMOS.

Type "N" will return to Setup Utility.

Appendix

Appendix A: Acronyms

Acor.	Meaning
ACPI	Advanced Configuration and Power Interface
POST	Power-On Self Test
LAN	Local Area Network
ECP	Extended Capabilities Port
APM	Advanced Power Management
DMA	Direct Memory Access
MHz	Megahertz
ESCD	Extended System Configuration Data
CPU	Central Processing Unit
SMP	Symmetric Multi-Processing
USB	Universal Serial Bus
OS	Operating System
ECC	Error Checking and Correcting
IDE	Integrated Dual Channel Enhanced
SCI	Special Circumstance Instructions
LBA	Logical Block Addressing
EMC	Electromagnetic Compatibility
BIOS	Basic Input / Output System
SMI	System Management Interrupt
IRQ	Interrupt Request
NIC	Network Interface Card
A.G.P.	Accelerated Graphics Port
S.E.C.C.	Single Edge Contact Cartridge
LED	Light Emitting Diode
EPP	Enhanced Parallel Port
CMOS	Complementary Metal Oxide Semiconductor
I/O	Input / Output
ESD	Electrostatic Discharge
OEM	Original Equipment Manufacturer
SRAM	Static Random Access Memory
VID	Voltage ID
DMI	Desktop Management Interface
MIDI	Musical Instrument Digital Interface
IOAPIC	Input Output Advanced Programmable Input Controller
DIMM	Dual Inline Memory Module
DRAM	Dynamic Random Access Memory
PAC	PCI A.G.P. Controller
AMR	Audio Modem Riser

6VTXE(-A) Motherboard

Acor.	Meaning
PCI	Peripheral Component Interconnect
RIMM	Rambus in-line Memory Module
DRM	Dual Retention Mechanism
ISA	Industry Standard Architecture
MTH	Memory Translator Hub
CRIMM	Continuity RIMM