

### FCC Compliance Statement:

<p style="text-align: center;"><b>DECLARATION OF CONFORMITY</b> <small>Per FCC Part 2 Section 2.1077(a)</small></p> <p style="text-align: center;"><b>FCC</b></p> <p>Responsible Party Name: G.B.T. INC. Address: 18305 Valley Blvd., Suite#A LA Puente, CA 91744 Phone/Fax No: (818) 854-9338 / (818) 854-9339</p> <p>hereby declares that the product Product Name: Mother Board Model Number: GA-6VMTA+</p> <p>Conforms to the following specifications: FCC Part 15, Subpart B, Section 15.107(a) and Section 15.109(a), Class B Digital Device</p> <p><b>Supplementary Information:</b> This device complies with part 15 of the FCC Rules. Operation is subject to the following two conditions: (1) This device may not cause harmful interference and (2) this device must accept any interference received, including that may cause undesired operation.</p> <p>Representative Person's Name: <u>ERIC LU</u> Signature: <u>Eric Lu</u> Date: <u>Feb. 11, 2000</u></p>
---

This equipment has been tested and found to comply with limits for a Class B digital device, pursuant to Part 15 of the FCC rules. These limits are designed to provide reasonable protection against harmful interference in residential installations. This equipment generates, uses, and can radiate radio frequency energy, and if not installed and used in accordance with the instructions, may cause harmful interference to radio communications. However, there is no guarantee that interference will not occur in a particular installation. If this equipment does cause interference to radio or television equipment reception, which can be

determined by turning the equipment off and on, the user is encouraged to try to correct the interference by one or more of the following measures:

- Reorient or relocate the receiving antenna
- Move the equipment away from the receiver
- Plug the equipment into an outlet on a circuit different from that to which the receiver is connected
- Consult the dealer or an experienced radio/television technician for additional suggestions

You are cautioned that any change or modifications to the equipment not expressly approved by the party responsible for compliance could void Your authority to operate such equipment.

This device complies with Part 15 of the FCC Rules. Operation is subjected to the following two conditions 1) this device may not cause harmful interference and 2) this device must accept any interference received, including interference that may cause undesired operation.

## Declaration of Conformity

We, Manufacturer/Importer  
(full address)

**G.B.T. Technology Trading GmbH**  
**Ausschlagler Weg 41, 1F, 20537 Hamburg, Germany**

declare that the product  
( description of the apparatus, system, installation to which it refers)

**Mother Board**  
**GA-6VM7A+**

is in conformity with  
(reference to the specification under which conformity is declared)  
in accordance with 89/336 EEC-EMC Directive

- |   |  |  |  |
|---|--|--|--|
| <input type="checkbox"/> EN 55011   | Limits and methods of measurement of radio disturbance characteristics of industrial, scientific and medical (ISM) high frequency equipment                | <input type="checkbox"/> EN 61000-3-2*<br><input checked="" type="checkbox"/> EN60555-2          | Disturbances in supply systems caused by household appliances and similar electrical equipment "Harmonics"   |
| <input type="checkbox"/> EN55013  | Limits and methods of measurement of radio disturbance characteristics of broadcast receivers and associated equipment                                     | <input type="checkbox"/> EN61000-3-3*<br><input checked="" type="checkbox"/> EN60555-3           | Disturbances in supply systems caused by household appliances and similar electrical equipment "Voltage fluctuations"                                  |
| <input type="checkbox"/> EN 55014   | Limits and methods of measurement of radio disturbance characteristics of household electrical appliances, portable tools and similar electrical apparatus | <input checked="" type="checkbox"/> EN 50081-1<br><input checked="" type="checkbox"/> EN 50082-1 | Generic emission standard Part 1: Residual, commercial and light industry<br>Generic immunity standard Part 1: Residual, commercial and light industry |
| <input type="checkbox"/> EN 55015   | Limits and methods of measurement of radio disturbance characteristics of fluorescent lamps and luminaries   | <input type="checkbox"/> EN 55081-2  | Generic emission standard Part 2: Industrial environment   |
| <input type="checkbox"/> EN 55020   | Immunity from radio interference of broadcast receivers and associated equipment   | <input type="checkbox"/> EN 55082-2  | Generic immunity standard Part 2: Industrial environment   |
| <input checked="" type="checkbox"/> EN 55022  | Limits and methods of measurement of radio disturbance characteristics of information technology equipment   | <input type="checkbox"/> ENV 55104   | Immunity requirements for household appliances tools and similar apparatus   |
| <input type="checkbox"/> DIN VDE 0855<br><input type="checkbox"/> part 10<br><input type="checkbox"/> part 12 | Cabled distribution systems; Equipment for receiving and/or <b>distribution</b> from sound and television signals  | <input type="checkbox"/> EN 50091- 2   | EMC requirements for uninterruptible power systems (UPS)   |
| <input checked="" type="checkbox"/> CE marking  |  |               | (EC conformity marking)  |

**The manufacturer also declares the conformity of above mentioned product with the actual required safety standards in accordance with LVD 73/23 EEC**

- |                                   |   |                                     |   |
|-----------------------------------|---|-------------------------------------|---|
| <input type="checkbox"/> EN 60065 | Safety requirements for mains operated electronic and related apparatus for household and similar general use | <input type="checkbox"/> EN 60950   | Safety for information technology equipment including electrical business equipment |
| <input type="checkbox"/> EN 60335 | Safety of household and similar electrical appliances   | <input type="checkbox"/> EN 50091-1 | General and Safety requirements for uninterruptible power systems (UPS)             |

**Manufacturer/Importer**

(Stamp)

Date : Feb. 11, 2000

Signature : Rex Lin  
Name : Rex Lin

**6VM7A+**  
**Socket 370 Processor Motherboard**

**USER'S MANUAL**

Socket 370 Processor Motherboard  
REV. 1.0 First Edition  
R-10-01-000131



## How This Manual Is Organized

This manual is divided into the following sections:

<b>1) Revision History</b>	Manual revision information
<b>2) Item Checklist</b>	Product item list
<b>3) Features</b>	Product information & specification
<b>4) Hardware Setup</b>	Instructions on setting up the motherboard
<b>5) Performance &amp; Block Diagram</b>	Product performance & block diagram
<b>6) BIOS Setup</b>	Instructions on setting up the BIOS software
<b>7) Appendix</b>	General reference



## Table Of Content

Revision History	P.1
Item Checklist	P.2
Summary of Features	P.3
6VM7A+ Motherboard Layout	P.5
Page Index for CPU Speed Setup / Connectors / Panel and Jumper Definition	P.6
Performance List	P.25
Block Diagram	P.26
Memory Installation	P.27
Page Index for BIOS Setup	P.28
Appendix	P.55

## Revision History

Revision	Revision Note	Date
1.0	Initial release of the 6VM7A+ motherboard user's manual.	Jan.2000

The author assumes no responsibility for any errors or omissions that may appear in this document nor does the author make a commitment to update the information contained herein. Third-party brands and names are the property of their respective owners.

Jan. 31, 2000 Taipei, Taiwan, R.O.C



## Item Checklist

- The 6VM7A+ motherboard
- Cable for IDE / floppy device
- Diskettes or CD (TUCD) for motherboard driver & utility
- Internal COM B Cable (Optional)
- Internal USB Cable (Optional)
- Cable for SCSI device
- 6VM7A+ user's manual

## Summary Of Features

Form Factor	<ul style="list-style-type: none"> <li>24.3 cm x 21.0 cm micro ATX size form factor, 4 layers PCB.</li> </ul>
CPU	<ul style="list-style-type: none"> <li>Socket 370 processor</li> <li>2nd cache in CPU(Depend on CPU)</li> </ul>
Chipset	<ul style="list-style-type: none"> <li>VT82C693A</li> <li>VT82C686A</li> </ul>
Clock Generator	<ul style="list-style-type: none"> <li>ICS 9248DF-39</li> <li>66/100/133 MHz system bus speeds (PCI 33MHz)</li> <li>75/83/112/124/140/150 MHz system bus speeds (PCI 44MHz) (reserved)</li> </ul>
Memory	<ul style="list-style-type: none"> <li>2 168-pin DIMM sockets.</li> <li>Supports PC-100 / PC-133 SDRAM and VCM SDRAM</li> <li>Supports up to 1.0GB DRAM (Max)</li> <li>Supports only 3.3V SDRAM DIMM</li> <li>Supports 72bit ECC type DRAM integrity mode.</li> </ul>
I/O Control	<ul style="list-style-type: none"> <li>VT82C686A</li> </ul>
Slots	<ul style="list-style-type: none"> <li>1 AGP slot supports 2X mode</li> <li>3 PCI slot supports 33MHz &amp; PCI 2.2 compliant</li> <li>1 AMR(Audio Modem Riser)slot</li> </ul>
On-Board IDE	<ul style="list-style-type: none"> <li>2 IDE bus master (DMA 33/ ATA 66) IDE ports for up to 4 ATAPI devices</li> <li>Supports PIO mode 3, 4 (UDMA33/ATA66) IDE &amp; ATAPI CD-ROM</li> </ul>
On-Board Peripherals	<ul style="list-style-type: none"> <li>1 floppy port supports 2 FDD with 360K, 720K, 1.2M, 1.44M and 2.88M bytes</li> <li>1 parallel ports supports SPP/EPP/ECP mode</li> <li>2 serial ports (COM A &amp; COM B)</li> <li>2 USB ports</li> </ul>
Hardware Monitor	<ul style="list-style-type: none"> <li>CPU/System fan revolution detect</li> <li>CPU /System temperature detect</li> <li>System voltage detect (Vcore,Vcc3,Vcc,+12V)</li> <li>CPU overheat shutdown detect</li> </ul>
PS/2 Connector	<ul style="list-style-type: none"> <li>PS/2<sup>®</sup> Keyboard interface and PS/2<sup>®</sup> Mouse interface</li> </ul>

To be continued...

---

Summary of Features

BIOS	<ul style="list-style-type: none"><li>• Licensed Award BIOS, 2M bit flash ROM</li></ul>
On-Board Sound	<ul style="list-style-type: none"><li>• Creative CT5880</li><li>• Line In / Line Out / Mic In / AUX In / CD In / TEL / SPDIF / Game port</li></ul>
Additional Features	<ul style="list-style-type: none"><li>• Includes 3 fan power connectors.</li><li>• Poly fuse for keyboard over-current protection</li></ul>

## 6VM7A+ Motherboard Layout

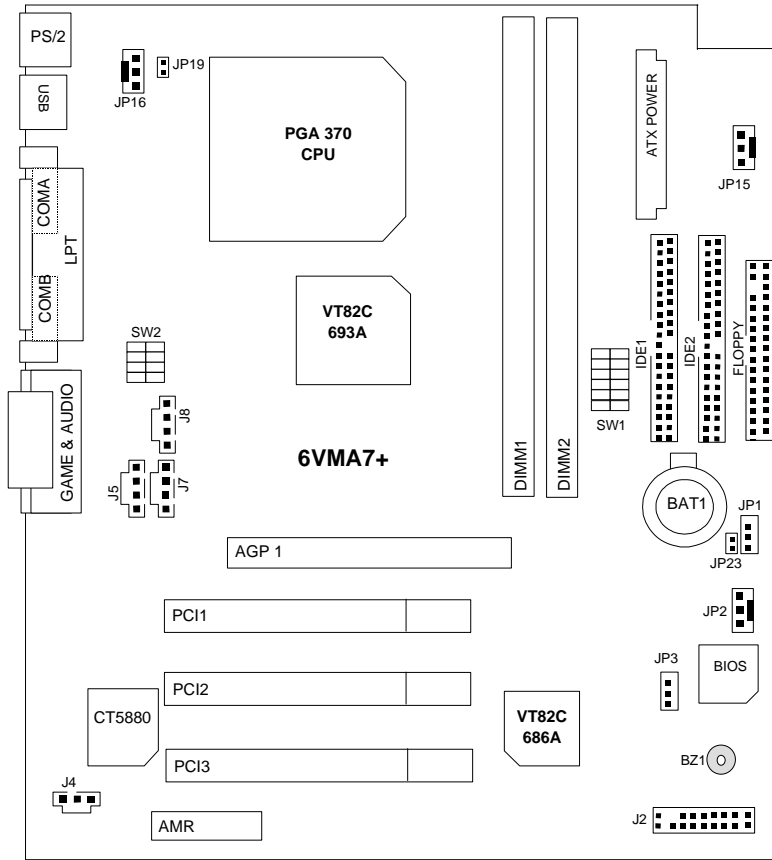

Page Index for CPU Speed Setup / Connectors / Panel and Jumper Definition	Page
CPU Speed Setup	P.7
Connectors	P.14
Game & Audio Port	P.14
COM A / COM B / LPT Port	P.14
USB Connector	P.15
PS/2 Keyboard & PS/2 Mouse Connector	P.15
JP16 (CPU Cooling Fan Power Connector)	P.16
JP15 (Power Cooling Fan Power Connector)	P.16
JP2 (System Cooling Fan Power Connector)	P.17
ATX Power	P.17
Floppy Port	P.18
IDE 1(Primary)/ IDE 2(Secondary) Port	P.18
J7 (TEL)	P.19
J5 (AUX_IN)	P.19
J8 (CD Audio Line In)	P.20
J4 (SPDIF)	P.20
Panel and Jumper Definition	P.21
J2 (2x11 Pins Jumper)	P.21
JP1 (Clear CMOS Function)	P.22
JP3 (Onboard Sound Function Selection)	P.22
JP23 (Case Open)	P.23
JP19 (Support Cyrix CPU Selection)[Optional]	P.23
BAT1(Battery)	P.24

## CPU Speed Setup

The system bus speed is selectable at 66,100,133MHz and Auto. The user can select the system bus speed (**SW1**) and change the DIP switch (**SW2**) selection to set up the CPU speed for 300 - 733MHz processor.

### Set System Bus Speed

SW1:

O : ON, X : OFF

CPU (MHz)	PCI(MHz)	1	2	3	4	5	6
Auto	33.3	X	X	X	X	O	O
66	33.3	O	O	X	X	X	X
75	37.5	O	O	O	X	X	X
83	41.6	O	O	X	O	X	X
100	33.3	O	X	X	X	X	X
112	37.3	O	X	O	X	X	X
124	31	X	X	X	O	X	X
133	33.3	X	X	X	X	X	X
140	35	X	X	O	O	X	X
150	37.5	X	X	O	X	X	X

The CPU speed must match with the frequency ratio. It will cause system hanging up if the frequency ratio is higher than that of CPU.

SW2:

FREQ. RATIO	DIP SWITCH			
	1	2	3	4
X 3	O	X	O	O
X 3.5	X	X	O	O
X 4	O	O	X	O
X 4.5	X	O	X	O
X 5	O	X	X	O
X 5.5	X	X	X	O
X 6	O	O	O	X
X 6.5	X	O	O	X
X 7	O	X	O	X
X 7.5	X	X	O	X
X 8	O	O	X	X
X 8.5	X	O	X	X
X 9	O	X	X	X
X 9.5	X	X	X	X

☞ For Auto Jumper Setting:

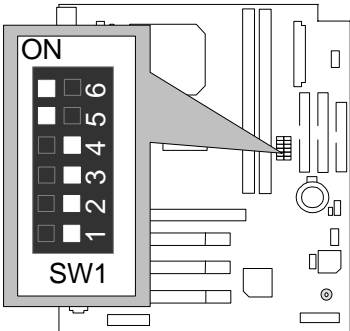

★Note:

- 1. If you use 66/100/133 MHz CPU, We recommend you to setup your system speed to "Auto" value.
- 2. We don't recommend you to set up your system speed to 75 , 83 , 112 , 124 , 140 ,150 MHz because these frequencies are not the standard specifications for CPU, Chipset and most of the peripherals. Whether your system can run under 75 ,83 ,112 ,124 ,140 ,150 MHz properly will depend on your hardware configurations: CPU, SDRAM, Cards, etc.

- 1. Celeron™ 300A/ 66 MHz FSB

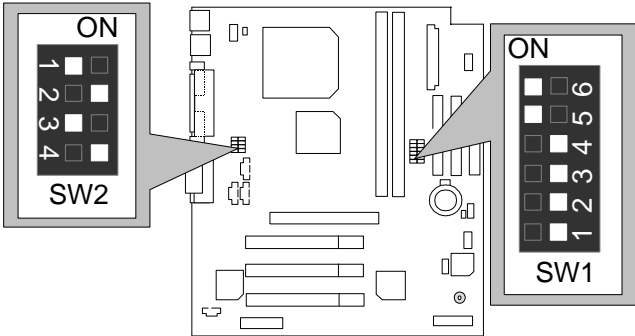

2. Celeron™ 333/ 66 MHz FSB

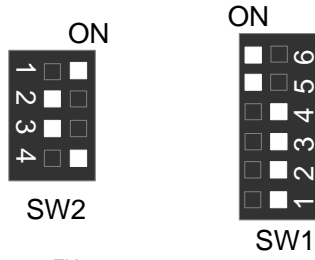

3. Celeron™ 366/ 66 MHz FSB

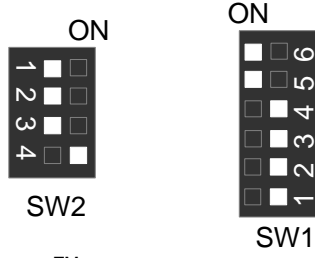

4. Celeron™ 400/ 66 MHz FSB

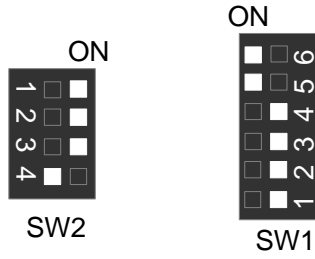

5. Celeron™ 433/ 66 MHz FSB

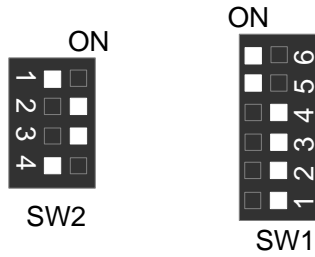



6. Celeron™ 466/ 66 MHz FSB

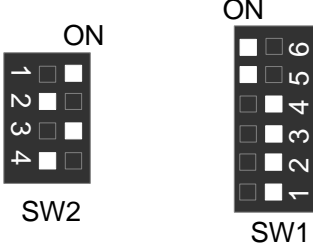

7. Celeron™ 500/ 66 MHz FSB

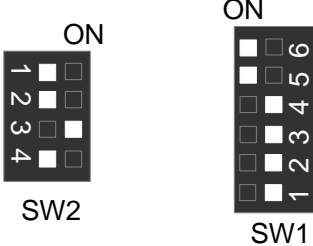

8. Celeron™ 533/ 66 MHz FSB

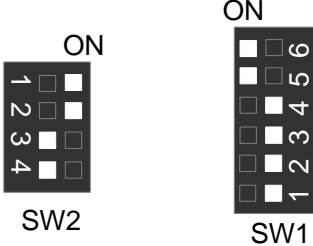

9. Celeron™ 566/ 66 MHz FSB

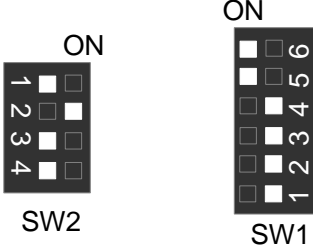

10. Cryix Joshua 300/100MHz FSB

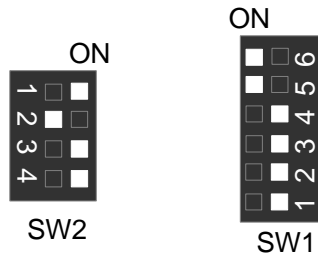

11. Coppermine 500/100MHz FSB

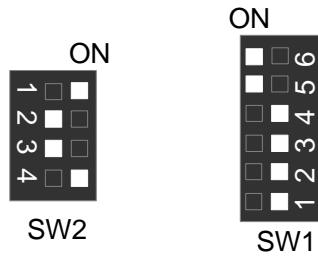

12. Coppermine 550/100MHz FSB

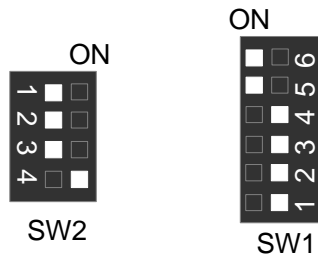

13. Coppermine 600/100MHz FSB

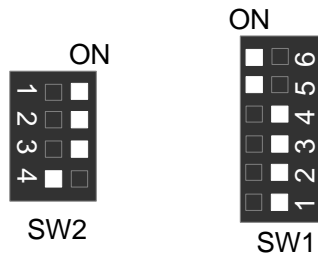

14. Coppermine 650/100MHz FSB

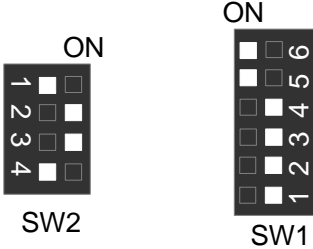

15. Coppermine 700/100MHz FSB

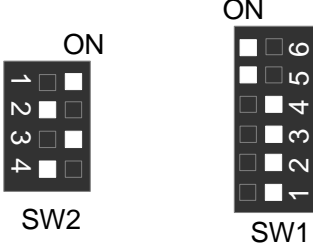

16. Coppermine 533/133MHz FSB

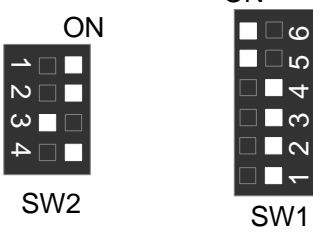

17. Coppermine 600/133 MHz FSB

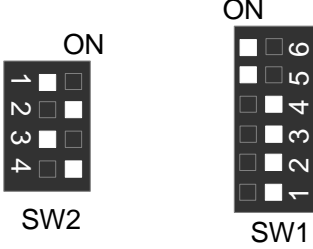

18. Coppermine 667/133MHz FSB

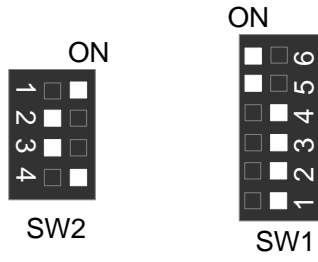

19. Coppermine 733/133MHz FSB

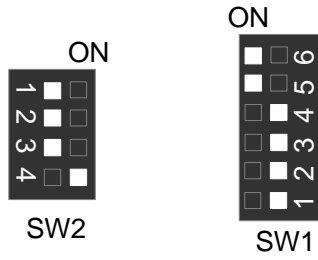

## Connectors

### Game & Audio Port

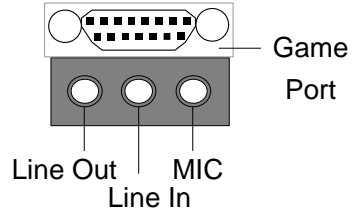
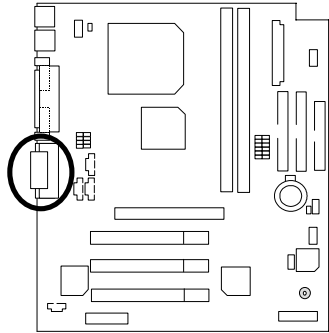

### COM A / COM B / LPT Port

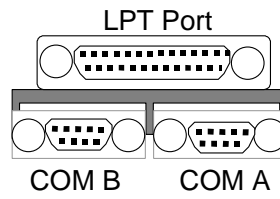
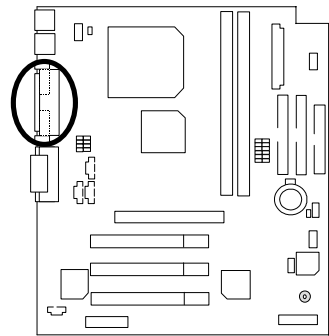

USB Connector

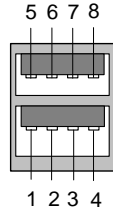
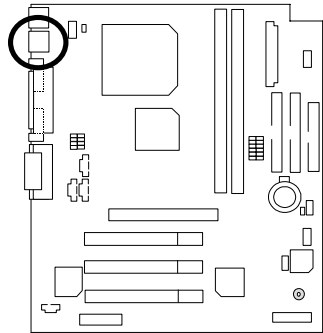

Pin No.	Definition
1	USB V0
2	USB D0-
3	USB D0+
4	GND
5	USB V1
6	USB D1-
7	USB D1+
8	GND

PS/2 Keyboard & PS/2 Mouse Connector

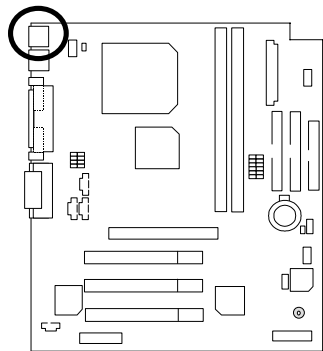

PS/2 Mouse

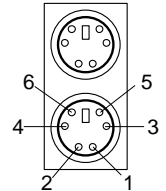

PS/2 Keyboard

PS/2 Mouse/Keyboard	
Pin No.	Definition
1	Data
2	NC
3	GND
4	VCC(+5V)
5	Clock
6	NC

## JP16: CPU Cooling Fan Power Connector

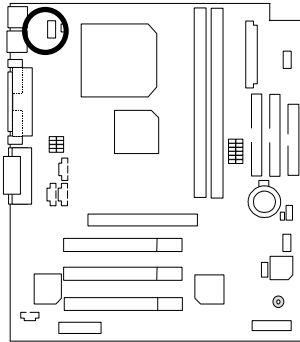

Pin No.	Definition
1	GND
2	+12V
3	SENSE

## JP15: Power Cooling Fan Power Connector

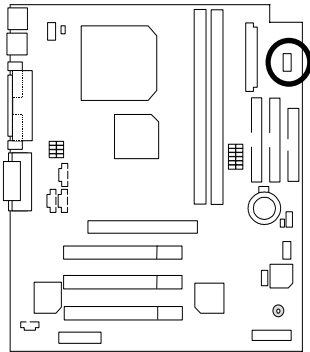

Pin No.	Definition
1	GND
2	+12V
3	NC

JP2: System Cooling Fan Power Connector

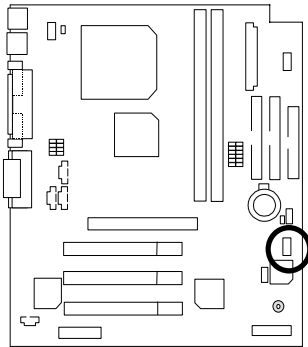

Pin No.	Definition
1	GND
2	+12V
3	SENSE

ATX Power

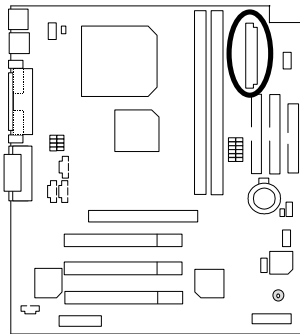

Pin No.	Definition
3,5,7,13, 15-17	GND
1,2,11	3.3V
4,6,19,20	VCC
10	+12V
12	-12V
18	-5V
8	Power Good
9	5V SB stand by+5V
14	PS-ON(Soft On/Off)



Floppy Port

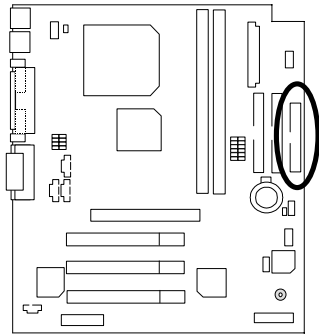

Red Line



FDD1

IDE1(Primary), IDE2(Secondary) Port

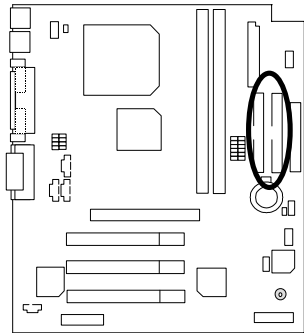

Red Line

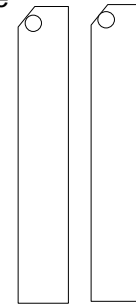

IDE 1 IDE 2

J7 : TEL: The connector is for Modem with internal voice connector

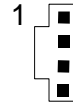
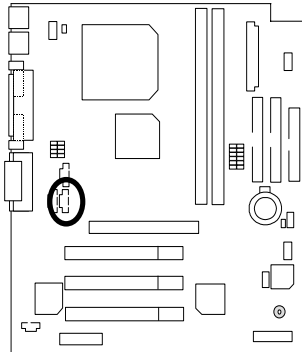

Pin No.	Definition
1	Signal-In
2	GND
3	GND
4	Signal-Out

J5:AUX\_IN

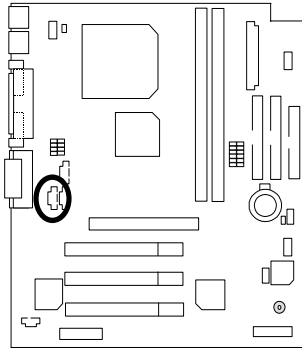

Pin No.	Definition
1	AUX-L
2	GND
3	GND
4	AUX-R

## J8 : CD Audio Line In

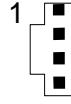
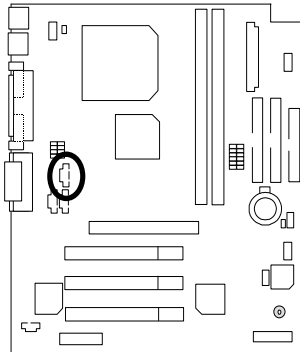

Pin No.	Definition
1	CD-L
2	GND
3	GND
4	CD-R

J4 : SPDIF (The SPDIF output is capable of providing digital audio to external speakers or compressed AC3 data to an external Dolby Digital decoder.)

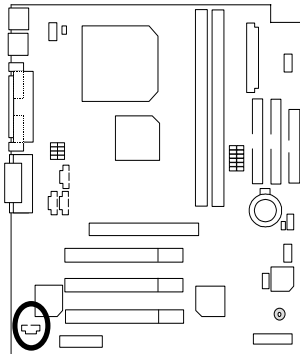

Pin No.	Definition
1	VCC
2	SPDIF OUT
3	GND

## Panel and Jumper Definition

J2 : 2x11 Pins Jumper

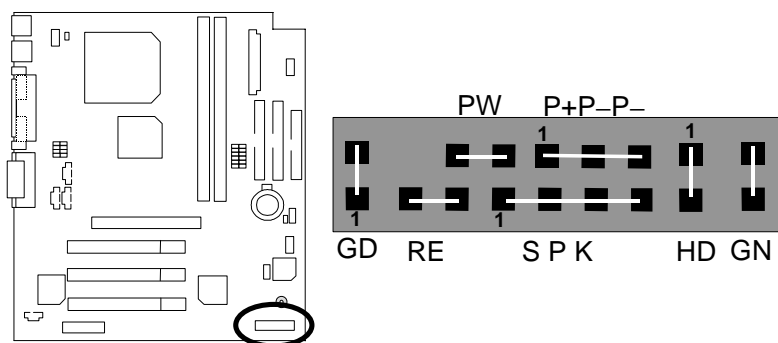

GN (Green Switch)	Open: Normal Operation Close: Entering Green Mode
GD (Green LED)	Pin 1: LED anode(+) Pin 2: LED cathode(-)
HD (IDE Hard Disk Active LED)	Pin 1: LED anode(+) Pin 2: LED cathode(-)
SPK (Speaker Connector)	Pin 1: VCC(+) Pin 2- Pin 3: NC Pin 4: Data(-)
RE (Reset Switch)	Open: Normal Operation Close: Reset Hardware System
P+P-P-(Power LED)	Pin 1: LED anode(+) Pin 2: LED cathode(-) Pin 3: LED cathode(-)
PW (Soft Power Connector)	Open: Normal Operation Close: Power On/Off

JP1 : Clear CMOS Function

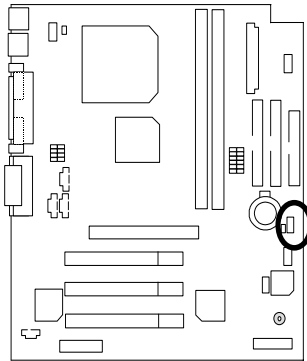

Pin No.	Definition
1-2 close	Normal (Default)
2-3 close	Clear CMOS

JP3 : Onboard Sound Function Selection

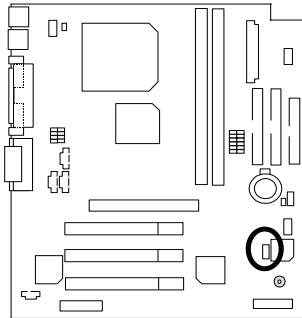

Pin No.	Definition
1-2 close	Onboard Sound Enable(Default)
2-3 close	Onboard Sound Disable

JP23 : Case Open

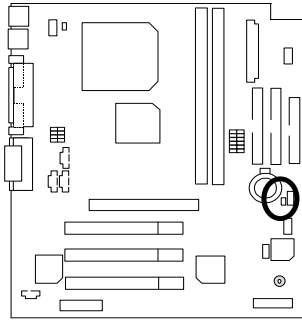

Pin No.	Definition
1	Signal
2	GND

JP19 : Support Cyrix CPU Selection(Optional)

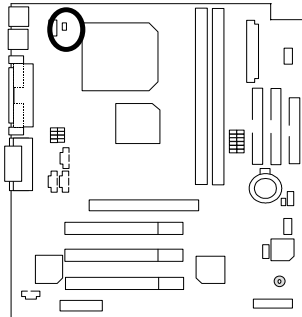

Pin No.	Definition
open	Normal
close	Support Cyrix 133MHz

BAT1 : Battery

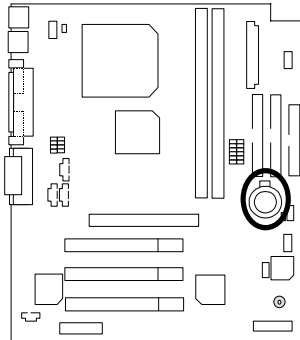

- ⓘ Danger of explosion if battery is incorrectly replaced.
- ⓘ Replace only with the same or equivalent type recommended by the manufacturer.
- ⓘ Dispose of used batteries according to the manufacturer's instructions.

## Performance List

The following performance data list is the testing results of some popular benchmark testing programs.

These data are just referred by users, and there is no responsibility for different testing data values gotten by users. (The different Hardware & Software configuration will result in different benchmark testing results.)

- CPU Intel Coppermine™ Socket 370 Processor
- DRAM (128 x 1) MB SDRAM (Winbond 902WB W986408BH-8H)
- CACHE SIZE 256 KB included in CPU
- DISPLAY GA-660+ AGP Card (32MB SDRAM)
- STORAGE Onboard IDE (IBM DTTA-371800) (18GB)
- O.S. Windows NT™ 4.0 (SP6)
- DRIVER Display Driver at 1024 x 768 x 64K x 75Hz

Processor	Intel Coppermine™ Socket 370 667MHz(133x5)
<b>Winbench99</b>	
CPU mark99	60.3
FPU Winmark 99	3570
Business Disk Winmark 99	5150
Hi-End Disk Winmark 99	10600
Business Graphics Winmark 99	316
Hi-End Graphics Winmark 99	617
<b>Winstone99</b>	
Business Winstone99	40.1
Hi-End Winstone99	37.8



# Block Diagram

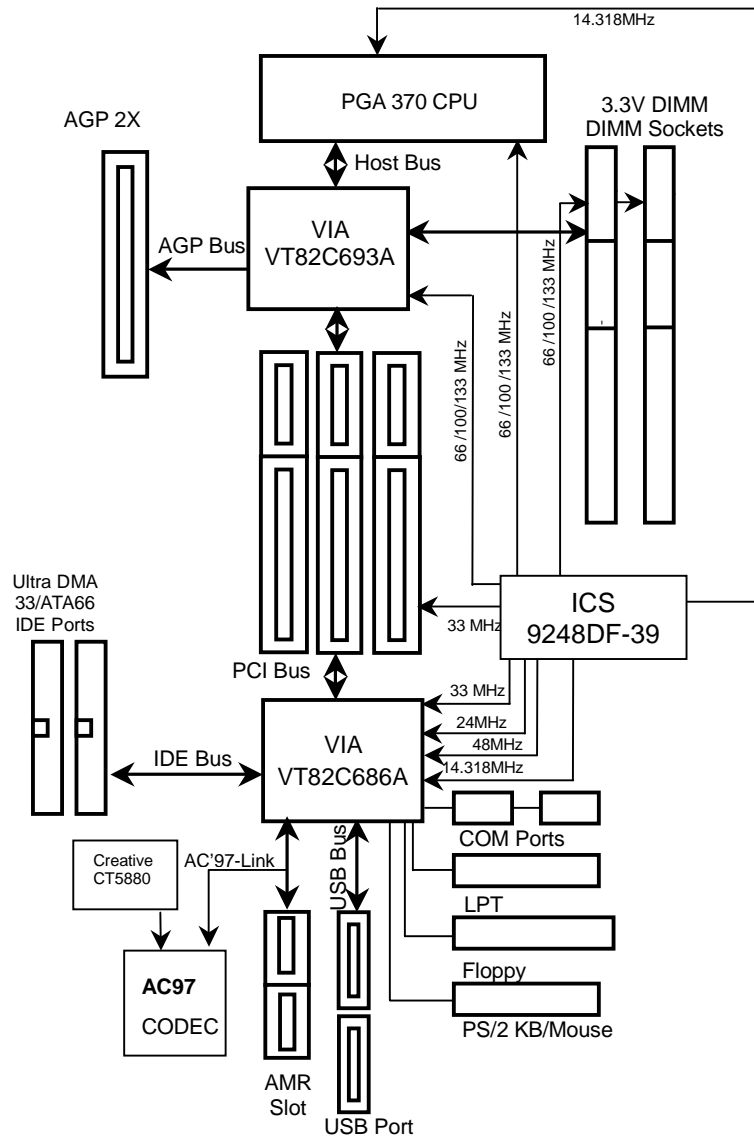

## Memory Installation

The motherboard has 2 dual inline memory module (DIMM) sockets. The BIOS will automatically detects memory type and size. To install the memory module, just push it vertically into the DIMM Slot .The DIMM module can only fit in one direction due to the two notch. Memory size can vary between sockets.

Install memory in any combination table:

DIMM	168-pin SDRAM DIMM Modules	
DIMM 1	Supports 16 / 32 / 64 / 128 / 256 / 512 MB	X 1 pcs
DIMM 2	Supports 16 / 32 / 64 / 128 / 256 / 512 MB	X 1 pcs

★ Total System Memory (Max 1GB)

---

 Page Index for BIOS Setup	Page
The Main Menu	P.30
Standard CMOS Setup	P.32
BIOS Features Setup	P.36
Chipset Features Setup	P.39
Power Management Setup	P.41
PNP/ PCI Configuration	P.44
Load BIOS Defaults	P.46
Load Performance Defaults	P.47
Integrated Peripherals	P.48
Supervisor Password / User Password	P.51
IDE HDD Auto Detection	P.52
Save to CMOS and Exit	P.53
Exit Without Saving	P.54

## BIOS Setup

BIOS Setup is an overview of the BIOS Setup Program. The program that allows users to modify the basic system configuration. This type of information is stored in battery-backed CMOS RAM so that it retains the Setup information when the power is turned off.

### ENTERING SETUP

Power ON the computer and press <Del> immediately will allow you to enter Setup. If the message disappears before you respond and you still wish to enter Setup, restart the system to try again by turning it OFF then ON or pressing the "RESET" bottom on the system case. You may also restart by simultaneously press <Ctrl> – <Alt>– <Del> keys.

### CONTROL KEYS

<↑>	Move to previous item
<↓>	Move to next item
<←>	Move to the item in the left hand
<→>	Move to the item in the right hand
<Esc>	Main Menu - Quit and not save changes into CMOS Status Page Setup Menu and Option Page Setup Menu - Exit current page and return to Main Menu
<+/PgUp>	Increase the numeric value or make changes
<-/PgDn>	Decrease the numeric value or make changes
<F1>	General help, only for Status Page Setup Menu and Option Page Setup Menu
<F2>	Change color from total 16 colors
<F3>	Calendar, only for Status Page Setup Menu
<F4>	Reserved
<F5>	Restore the previous CMOS value from CMOS, only for Option Page Setup Menu
<F6>	Load the default CMOS value from BIOS default table, only for Option Page Setup Menu
<F7>	Load the Defaults.
<F8>	Reserved
<F9>	Reserved
<F10>	Save all the CMOS changes, only for Main Menu

**GETTING HELP**

**Main Menu**

The on-line description of the highlighted setup function is displayed at the bottom of the screen.

**Status Page Setup Menu / Option Page Setup Menu**

Press F1 to pop up a small help window that describes the appropriate keys to use and the possible selections for the highlighted item. To exit the Help Window press <Esc>.

**The Main Menu**

Once you enter Award BIOS CMOS Setup Utility, the Main Menu (Figure 1) will appear on the screen. The Main Menu allows you to select from nine setup functions and two exit choices. Use arrow keys to select among the items and press <Enter> to accept or enter the sub-menu.

ROM PCI / ISA BIOS (2A6LGG0T) CMOS SETUP UTILITY AWARD SOFTWARE, INC.	
STANDARD CMOS SETUP	INTEGRATED PERIPHERALS
BIOS FEATURES SETUP	SUPERVISOR PASSWORD
CHIPSET FEATURES SETUP	USER PASSWORD
POWER MANAGEMENT SETUP	IDE HDD AUTO DETECTION
PNP/PCI CONFIGURATION	SAVE & EXIT SETUP
LOAD BIOS DEFAULTS	EXIT WITHOUT SAVING
LOAD PERFORMANCE DEFAULTS	
ESC : Quit	↑↓←→ : Select Item
F10 : Save & Exit Setup	(Shift) F2 : Change Color

Figure 1: Main Menu

- **Standard CMOS Setup**  
This setup page includes all the items in standard compatible BIOS.
- **BIOS Features Setup**  
This setup page includes all the items of Award special enhanced features.

- **Chipset Features Setup**

This setup page includes all the items of chipset special features.
- **Power Management Setup**

This setup page includes all the items of Green function features.
- **PnP/PCI Configurations**

This setup page includes all the configurations of PCI & PnP ISA resources.
- **Load BIOS Defaults**

Bios Defaults indicates the value of the system parameter which the system would be in the safe configuration.
- **Load Performance Defaults**

Performance Defaults indicates the value of the system parameter which the system would be in the most appropriate configuration.
- **Integrated Peripherals**

This setup page includes all onboard peripherals.
- **Supervisor password**

Change, set, or disable password. It allows you to limit access to the system and Setup, or just to Setup.
- **User password**

Change, set, or disable password. It allows you to limit access to the system.
- **IDE HDD auto detection**

Automatically configure hard disk parameters.
- **Save & Exit Setup**

Save CMOS value settings to CMOS and exit setup.
- **Exit Without Saving**

Abandon all CMOS value changes and exit setup.

## Standard CMOS Setup

The items in Standard CMOS Features Menu (Figure 2) are divided into 9 categories. Each category includes no, one or more than one setup items. Use the arrows to highlight the item and then use the <PgUp> or <PgDn> keys to select the value you want in each item.

ROM PCI / ISA BIOS (2A6LGG0T) CMOS SETUP UTILITY AWARD SOFTWARE, INC.									
Date (mm.dd:yyyy) : Thu Jan 27, 2000 Time (hh:mm:ss) : 10:36:24									
		TYPE	SIZE	CYLS	HEAD	PRECOMP	LANDZ	SECTOR	MODE
Primary Master	:	AUTO	0M	0	0	0	0	0	AUTO
Primary Slave	:	AUTO	0M	0	0	0	0	0	AUTO
Secondary Master:	:	AUTO	0M	0	0	0	0	0	AUTO
Secondary Slave	:	AUTO	0M	0	0	0	0	0	AUTO
Driver A: 1.44 M 3.5 in					Base Memory : 640 K				
Driver B: None					Other Memory: 130048 K				
Floppy 3 Mode Support : Disabled					Extended Memory: 384 K				
Video: EGA / VGA					Total Memory: 131072K				
Halt On: All, But Keyboard									
ESC : Quit			↑↓←→ : Select Item			PU/PD/+/-: Modify			
F1 : Help			(Shift) F2 : Change Color						

Figure 2: Standard CMOS Setup

- **Date**

The date format is <Week>, <Month>, <Day>, <Year>.

Week	The week, from Sun to Sat, determined by the BIOS and is display-only
Month	The month, Jan. Through Dec.
Day	The day, from 1 to 31 (or the maximum allowed in the month)
Year	The year, from 1994 through 2079

- **Time**

The times format in <hour> <minute> <second>. The time is calculated base on the 24-hour military-time clock. For example, 1 p.m. is 13:00:00.

- **IDE Primary Master, Slave / Secondary Master, Slave**

The category identifies the types of hard disk from drive C to F that has been installed in the computer. There are two types: auto type, and user definable type. User type is user-definable; Auto type which will automatically detect HDD type.

Note that the specifications of your drive must match with the drive table. The hard disk will not work properly if you enter improper information for this category.

If you select User Type, related information will be asked to enter to the following items. Enter the information directly from the keyboard and press <Enter>. Such information should be provided in the documentation form your hard disk vendor or the system manufacturer.

CYLS.	Number of cylinders
HEADS	number of heads
PRECOMP	write precomp
LANDZONE	Landing zone
SECTORS	number of sectors

If a hard disk has not been installed select NONE and press <Enter>.

- **Drive A type / Drive B type**

The category identifies the types of floppy disk drive A or drive B that has been installed in the computer.

None	No floppy drive installed
360K, 5.25 in.	5.25 inch PC-type standard drive; 360K byte capacity.
1.2M, 5.25 in.	5.25 inch AT-type high-density drive; 1.2M byte capacity (3.5 inch when 3 Mode is Enabled).
720K, 3.5 in.	3.5 inch double-sided drive; 720K byte capacity
1.44M, 3.5 in.	3.5 inch double-sided drive; 1.44M byte capacity.
2.88M, 3.5 in.	3.5 inch double-sided drive; 2.88M byte capacity.

- **Floppy 3 Mode Support (for Japan Area)**

Disabled	Normal Floppy Drive.
Drive A	Drive A is 3 mode Floppy Drive.
Drive B	Drive B is 3 mode Floppy Drive.
Both	Drive A & B are 3 mode Floppy Drives.



- **Video**

The category detects the type of adapter used for the primary system monitor that must match your video display card and monitor.

Although secondary monitors are supported, you do not have to select the type in setup.

EGA/VGA	Enhanced Graphics Adapter/Video Graphics Array. For EGA, VGA, SVGA, or PGA monitor adapters
CGA 40	Color Graphics Adapter, power up in 40 column mode
CGA 80	Color Graphics Adapter, power up in 80 column mode
MONO	Monochrome adapter, includes high resolution monochrome adapters

- **Halt on**

The category determines whether the computer will stop if an error is detected during power up.

NO Errors	The system boot will not be stopped for any error that may be detected
All Errors	Whenever the BIOS detects a non-fatal error, the system will be stopped and you will be prompted
All, But Keyboard	The system boot will not stop for a keyboard error; it will stop for all other errors
All, But Diskette	The system boot will not stop for a disk error; it will stop for all other errors
All, But Disk/Key	The system boot will not stop for a keyboard or disk error; it will stop for all other errors

- **Memory**

The category is display-only which is determined by POST (Power On Self Test) of the BIOS.

**Base Memory**

The POST of the BIOS will determine the amount of base (or conventional) memory installed in the system.

The value of the base memory is typically 512 K for systems with 512 K memory installed on the motherboard, or 640 K for systems with 640 K or more memory installed on the motherboard.

**Extended Memory**

The BIOS determines how much extended memory is present during the POST.

This is the amount of memory located above 1 MB in the CPU's memory address map.

**Other Memory**

This refers to the memory located in the 640 K to 1024 K address space. This is memory that can be used for different applications.

DOS uses this area to load device drivers to keep as much base memory free for application programs. Most use for this area is Shadow RAM

## BIOS Features Setup

ROM PCI / ISA BIOS (2A6LGG0T) CMOS SETUP UTILITY AWARD SOFTWARE, INC.	
Virus Warning	: Disabled
Process Number Feature	: Enabled
Boot From LAN First	: Disabled
Boot Sequence	: A,C,SCSI
VGA Boot From	: AGP
Boot Up Floppy Seek	: Enabled
Boot Up NumLock Status	: On
Memory Parity/ECC Check	: Disabled
Typematic Rate Setting	: Disabled
Typematic Rate (Chars/Sec)	: 6
Typematic Delay (Msec)	: 250
Security Option	: Setup
PCI/VGA Palette Snoop	: Disabled
Assign IRQ For VGA	: Enabled
HDD S.M.A.R.T. Capability	: Disabled
Report No FDD For WIN 95	: No
ESC : Quit                    ↑↓←→: Select Item F1 : Help                    PU/PD/+/- : Modify F5 : Old Values            (Shift)F2 :Color F6 : Load BIOS Defaults F7 : Load Performance Defaults	

Figure 3: BIOS Features Setup

- **Virus Warning**

If it is set to enable, the category will flash on the screen when there is any attempt to write to the boot sector or partition table of the hard disk drive. The system will halt and the following error message will appear in the mean time. You can run anti-virus program to locate the problem.

Enabled	Activate automatically when the system boots up causing a warning message to appear when anything attempts to access the boot sector or hard disk partition table
Disabled	No warning message to appear when anything attempts to access the boot sector or hard disk partition table <b>(Default Value)</b>

- **Processor Number Feature**

Enabled	Enable Processor number feature. <b>(Default Value)</b>
Disabled	Disable Processor number feature.

- **Boot From LAN First**

Enabled	Enable Boot From LAN First.
Disabled	Disable Boot From LAN First. <b>(Default Value)</b>
Auto	Auto detect Boot From LAN First.

⇒ You can set "Auto" or "Enabled" to boot from LAN first.

- **Boot Sequence**

This category determines which drive computer searches first for the disk operating system (i.e., DOS). Default value is A, C, SCSI.

X1, X2, X3	System will first search for X1 disk drive then X2 disk drive and then X3 disk drive.
------------	---

- **VGA Boot From**

PCI Slot	System will boot from PCI slot VGA card.
AGP	System will boot from AGP display card. <b>(Default Value)</b>

- **Boot Up Floppy Seek**

During POST, BIOS will determine the floppy disk drive installed is 40 or 80 tracks. 360 K type is 40 tracks 720 K, 1.2 M and 1.44 M are all 80 tracks.

Enabled	BIOS searches for floppy disk drive to determine it is 40 or 80 tracks. Note that BIOS can not tell from 720 K, 1.2 M or 1.44 M drive type as they are all 80 tracks. <b>(Default Value)</b>
Disabled	BIOS will not search for the type of floppy disk drive by track number. Note that there will not be any warning message if the drive installed is 360 K.

- **Boot Up NumLock Status**

On	Keypad is number keys. <b>(Default Value)</b>
Off	Keypad is arrow keys.

- **Memory Parity/ECC Check**

Enabled	Enabled Memory Parity/ECC Check Function.
Disabled	Disabled Memory Parity/ECC Check Function. <b>(Default Value)</b>

- **Typematic Rate Setting**

Enabled	Enable Keyboard Typematic rate setting.
Disabled	Disable Keyboard Typematic rate setting. <b>(Default Value)</b>

- **Typematic Rate (Chars / Sec.)**

6-30	Set the maximum Typematic rate from 6 chars. Per second to 30 characters. Per second. <b>(Default Value: 6)</b>
------	---

- **Typematic Delay (Msec.)**

250-1000	Set the time delay from first key to repeat the same key in to computer <b>(Default Value: 250)</b> .
----------	---

- **Security Option**

This category allows you to limit access to the system and Setup, or just to Setup.

System	The system can not boot and can not access to Setup page will be denied if the correct password is not entered at the prompt.
Setup	The system will boot, but access to Setup will be denied if the correct password is not entered at the prompt. <b>(Default Value)</b>

- **PCI/VGA Palette Snoop**

Enabled	For having Video Card on ISA Bus and VGA Card on PCI Bus.
Disabled	For VGA Card only. <b>(Default Value)</b>

- **Assign IRQ For VGA**

Enabled	Assign IRQ For VGA. <b>(Default Value)</b>
Disabled	Not assign IRQ For VGA.

- **HDD S.M.A.R.T. Capability**

Enabled	Enabled HDD S.M.A.R.T. Capability.
Disabled	Disabled HDD S.M.A.R.T. Capability. <b>(Default Value)</b>

- **Report No FDD For WIN 95**

No	Assign IRQ6 For FDD. <b>(Default Value)</b>
Yes	FDD Detect IRQ6 Automatically.

## Chipset Features Setup

ROM PCI / ISA BIOS (2A6LGG0T) CMOS SETUP UTILITY AWARD SOFTWARE, INC			
Top Performance	:Disabled	Current CPU Temp.	: 42°C/107°F
SDRAM Cycle Length	:3	Current System Temp.	: 28°C/82°F
DRAM Clock	:Host CLK	Current CPU FAN 1 Speed	:5978 RPM
Read Around Write	:Enabled	Current CPU FAN 2 Speed	:0 RPM
Concurrent PCI/Host	:Disabled	Vcore	: 1.65V
AGP Aperture Size	:64MB	3.3V	: 3.38V
OnChip Sound	:Auto	5V	: 5.10V
OnChip Modem	:Auto	12V	: 12.36V
Spread Spectrum	:Disabled		
		ESC : Quit                   ↑↓←→: Select Item	
		F1 : Help                    PU/PD/+/- : Modify	
		F5 : Old Values            (Shift)F2 :Color	
		F6 : Load BIOS Defaults	
		F7 : Load Performance Defaults	

Figure 4: Chipset Features Setup

- **Top Performance**

Disabled	Set Top Performance function disabled. <b>(Default Value)</b>
Enabled	Set Top Performance function disabled.

- **SDRAM Cycle Length**

Auto	Set SDRAM Cycle Length is Auto.
3	For Slower SDRAM DIMM module. <b>(Default Value)</b>
2	For Fastest SDRAM DIMM module.

- **DRAM Clock**

CPU CLK	DRAM CLK
66,75,83	Host CLK. <b>(Default Value)</b>
	Host CLK +33M.
100,112,124,133,140,150	Host CLK. <b>(Default Value)</b>

- **Read Around write**

Enabled	When set Enabled this feature speeds up data read performance. <b>(Default Value)</b>
Disabled	Normal operation.

- **Concurrent PCI/Host**

Enabled	Enabled Concurrent PCI/Host.
Disabled	Disabled Concurrent PCI/Host. <b>(Default Value)</b>

- **AGP Aperture Size**

4MB	Set AGP Aperture Size to 4MB.
8MB	Set AGP Aperture Size to 8 MB.
16MB	Set AGP Aperture Size to 16 MB.
32MB	Set AGP Aperture Size to 32 MB.
64MB	Set AGP Aperture Size to 64 MB. <b>(Default Value)</b> .
128MB	Set AGP Aperture Size to 128 MB.

- **OnChip Sound**

Auto	Enabled Onchip sound. <b>(Default Value)</b>
Disabled	Disabled Onchip sound.

- **OnChip Modem**

Auto	Enabled Onchip Modem. <b>(Default Value)</b>
Disabled	Disabled Onchip Modem.

- **Spread Spectrum**

Disabled	Spread Spectrum Disabled. <b>(Default Value)</b>
Enabled	Spread Spectrum function Enabled.

- **Current CPU Temp (°C / °F)**

Detect CPU Temp. automatically.

- **Current System Temp (°C / °F)**

Detect System Temp. automatically.

- **Current FAN Speed (RPM)**

Detect FAN Speed status automatically.

- **Current Voltage (V) VCORE / 3.3V / 12V / 5V**

Detect System's voltage status automatically.

## Power Management Setup

ROM PCI / ISA BIOS (2A6LGG0T) CMOS SETUP UTILITY AWARD SOFTWARE, INC			
Power Management	:Enabled	Primary INTR	:ON
Video Off Method	:DPMS Support	IRQ 3 (COM 2)	:Primary
Soft-Off by PWRBTN	:Instant-Off	IRQ 4 (COM 1)	:Primary
PWRON After PW-Fail	:Formar-Sts	IRQ 5 (LPT 2)	:Primary
CPU FAN In Suspend	:Off	IRQ 6 (Floppy Disk)	:Primary
HDD Power Down	:Disabled	IRQ 7 (LPT 1)	:Primary
Suspend Mode	:Disabled	IRQ 8 (RTC Alarm)	:Disabled
<b>** PM Events **</b>		IRQ 9 (IRQ Redir)	:Secondary
VGA	:OFF	IRQ 10 (Reserved)	:Secondary
LPT & COM	:LPT/COM	IRQ 11 (Reserved)	:Secondary
HDD & FDD	:ON	IRQ 12 (PS/2 Mouse)	:Primary
PCI Master	:OFF	IRQ 13 (Coprocessor)	:Primary
Wake Up on RI#	:Enabled	IRQ 14 (Hard Disk)	:Primary
Wake Up on PEM#	:Enabled	IRQ 15 (Reserved)	:Disabled
RTC Alarm Resume	:Disabled	ESC : Quit	↑↓←→: Select Item
* Date(of Month)	:0	F1 : Help	PU/PD/+/- : Modify
* Time(hh:mm:ss)	:0 0 :0	F5 : Old Values (Shift)	F2 : Color
		F6 : Load BIOS Defaults	
		F7 : Load Performance Defaults	

Figure 5: Power Management Setup

- **Power Management**

Enabled	For configuring our own power management features. <b>(Default Value)</b>
Min Saving	Enable Green function.
Max Saving	Disable Green function.

- **Video Off Method**

V/H SYNC + Blank	BIOS will turn off V/H-SYNC when gets into Green mode for Green monitor power saving.
Blank Screen	BIOS will only black monitor when gets into Green mode.
DPMS Support	BIOS will use DPMS Standard to control VGA card. (The Green type VGA card will turn of V/H-SYNC automatically.) <b>(Default Value)</b>

- **Soft-off by PWRBTN**

Instant-off	Soft switch ON/OFF for power ON/OFF. <b>(Default Value)</b>
Delay 4 sec	Soft switch on 4sec for power OFF.



- **PWRON After PW-Fail**

Former-Sts	Set Restore on AC/Power Loss is Former-Sts mode. <b>(Default Value)</b>
On	Set Restore on AC/Power Loss is Power on.
Off	Set Restore on AC/Power Loss is Power off.

- **CPU FAN In Suspend**

On	Disable this function.
Off	Stop CPU FAN when entering Suspend mode. <b>(Default Value)</b>

- **HDD Power Down**

Disabled	Disabled HDD Power Down mode function. <b>(Default Value)</b>
1-15 mins.	Enabled HDD Power Down mode between 1 to 15 mins.

- **Suspend Mode**

Disabled	Disabled Suspend Mode. <b>(Default Value)</b>
10 Sec - 1 Hour	Setup the timer to enter Suspend Mode.

- **VGA**

OFF	Disable monitor VGA activity. <b>(Default Value)</b>
ON	Enable monitor VGA activity.

- **LPT & COM**

LPT/COM	Enabled LPT/COM Ports Activity. <b>(Default Value)</b>
NONE	Normal Operation.
LPT	Enabled LPT Ports Activity.
COM	Enabled COM Ports Activity.

- **HDD & FDD**

ON	Enabled HDD & FDD Ports Activity. <b>(Default Value)</b>
OFF	Disabled HDD & FDD Ports Activity.

- **PCI master**

ON	Don't detect DMA/master PM event.
OFF	Normal Operation. <b>(Default Value)</b>

- **Wake Up On RI#**

Enabled	Enable Wake Up On LAN/Ring. <b>(Default Value)</b>
Disabled	Disable Wake Up On LAN/Ring.

- **Wake Up On PME#**

Enabled	Enable Wake Up On PME#. <b>(Default Value)</b>
Disabled	Disable Wake Up On PME#.

- **RTC Alarm Resume**

You can set "RTC Alarm Resume" item to enabled and key in date/time to power on system.

Disabled	Disable this function. <b>(Default Value)</b>
Enabled	Enable alarm function to POWER ON system.

If the "RTC Alarm Resume" is Enabled.

Date ( of Month) :	0-31
Time ( hh: mm: ss) :	(0-23) : (0-59) : (0-59)

- **Primary INTR**

ON	Primary INTR function is on. <b>(Default Value)</b>
OFF	Normal Operation.

- **IRQ [3~15]**

Disabled	Disable this function.
Primary	The resource is used by Primary device .
Secondary	The resource is used by Secondary device .

**PNP/PCI Configurations**

ROM PCI / ISA BIOS (2A6LGG0T) CMOS SETUP UTILITY AWARD SOFTWARE, INC.	
PNP OS Installed :No Resources Controlled By :Auto Reset Configuration Data :Disabled	Assign IRQ For USB :Enabled
IRQ-3 assigned to :PCI/ISA PnP IRQ-4 assigned to :PCI/ISA PnP IRQ-5 assigned to :PCI/ISA PnP IRQ-7 assigned to :PCI/ISA PnP IRQ-9 assigned to :PCI/ISA PnP IRQ-10 assigned to :PCI/ISA PnP IRQ-11 assigned to :PCI/ISA PnP IRQ-12 assigned to :PCI/ISA PnP IRQ-14 assigned to :PCI/ISA PnP IRQ-15 assigned to :PCI/ISA PnP DMA-0 assigned to :PCI/ISA PnP DMA-1 assigned to :PCI/ISA PnP DMA-3 assigned to :PCI/ISA PnP DMA-5 assigned to :PCI/ISA PnP DMA-6 assigned to :PCI/ISA PnP DMA-7 assigned to :PCI/ISA PnP	ESC : Quit                   ↑↓←→: Select Item F1 : Help                    PU/PD/+/- : Modify F5 : Old Values (Shift)F2 :Color F6 : Load BIOS Defaults F7 : Load Performance Defaults

Figure 6: PnP/PCI Configuration

- **PNP OS Installed**

Yes	Enable PNP OS Installed function.
No	Disable PNP OS Installed function. <b>(Default Value)</b>

- **Resources Controlled by**

Manual	User can set the PnP resource (I/O Address, IRQ & DMA channels) used by legacy ISA DEVICE.
Auto	BIOS automatically use these PnP rescuers. <b>(Default Value)</b>

- **Reset Configuration Data**

Disabled	Disable this function. <b>(Default Value)</b>
ESCD	Enable clear PnP information in ESCD.
DMI	Enable clear PnP information in DMI.
BOTH	Enable clear PnP information in ESCD and DMI.

- **IRQ (3,4,5,7,9,10,11,12,14,15), DMA(0,1,3,5,6,7) assigned to**

●<sup>sc</sup> IRQ[3.4.5.7.9.10.11.12.14.15] & DMA[0.1.3.5.6.7] These items will show up when "Resources Controlled By" is Manual.

PCI/ISA PnP	The resource is used by PCI/ISA PnP device (PCI or ISA).
Legacy ISA	The resource is used by Legacy ISA device.

- **Assign IRQ For USB**

Enabled	Assign a specific IRQ for USB. <b>(Default Value)</b>
Disabled	No IRQ is assigned for USB.

## Load BIOS Defaults

ROM PCI / ISA BIOS (2A6LGG0T) CMOS SETUP UTILITY AWARD SOFTWARE, INC.	
STANDARD CMOS SETUP	INTEGRATED PERIPHERALS
BIOS FEATURES SETUP	SUPERVISOR PASSWORD
CHIPSET FEATURES SETUP	USER PASSWORD
POWER MANAGEMENT SETUP	IDE HDD AUTO DETECTION
PNP/PCI CONFIGURATION	
<b>LOAD BIOS DEFAULTS</b>	<div style="border: 2px solid black; padding: 5px;">                     Load BIOS Defaults (Y/N) ? N                 </div>
LOAD PERFORMANCE DEFAULTS	
ESC : Quit	↑↓←→ : Select Item
F10 : Save & Exit Setup	(Shift) F2 : Change Color
Load BIOS Defaults except Standard CMOS SETUP	

Figure 7: Load BIOS Defaults

- **Load BIOS Defaults**

BIOS defaults contain the most appropriate values of the system parameters that allow minimum system performance.

## Load Performance Defaults

ROM PCI / ISA BIOS (2A6LGG0T) CMOS SETUP UTILITY AWARD SOFTWARE, INC.	
STANDARD CMOS SETUP	INTEGRATED PERIPHERALS
BIOS FEATURES SETUP	SUPERVISOR PASSWORD
CHIPSET FEATURES SETUP	USER PASSWORD
POWER MANAGEMENT SETUP	IDE HDD AUTO DETECTION
PNP/PCI CONFIGUR	<b>Load Performance Defaults (Y/N) ? N</b>
LOAD BIOS DEFAULT	
<b>LOAD PERFORMANCE DEFAULTS</b>	
ESC : Quit	↑↓←→ : Select Item
F10 : Save & Exit Setup	(Shift) F2 : Change Color
Load Setup Defaults except Standard CMOS SETUP	

Figure 8: Load Performance Defaults

- **Load Performance Defaults**

Selecting this field loads the factory defaults for BIOS and Chipset Features which the system automatically detects.

## Integrated Peripherals

ROM PCI / ISA BIOS (2A6LGG0T) CMOS SETUP UTILITY AWARD SOFTWARE, INC.	
USB Controller	: Enabled
USB Keyboard Support	: Disabled
Onboard Serial Port 1	: Auto
Onboard Serial Port 2	: Auto
Onboard Parallel Port	:378/IRQ7
Onboard Parallel Mode	:SPP
Onboard Legacy Audio	:Enabled
Sound Blaster	:Disabled
SB I/O Base Address	:220H
SB IRQ Select	:IRQ5
SB DMA Select	:DMA1
MPU-401	:Disabled
MPU-401 I/O Address	:330-333H
Game port(200~207H)	:Enabled
ESC : Quit                    ↑↓←→: Select Item F1    : Help                    PU/PD/+/- : Modify F5    : Old Values            (Shift)F2 : Color F6    : Load BIOS Defaults F7    : Load Performance Defaults	

Figure 9: Integrated Peripherals

- **USB Controller**

Enabled	Enabled SB Controller. <b>(Default Value)</b>
Disabled	Disabled USB Controller.

- **USB Keyboard Support**

Enabled	Enabled USB Keyboard Support.
Disabled	Disabled USB Keyboard Support. <b>(Default Value)</b>

- **Onboard Serial Port 1**

Auto	BIOS will automatically setup the port 1 address. <b>(Default Value)</b>
3F8/IRQ4	Enable onboard Serial port 1 and address is 3F8.
2F8/IRQ3	Enable onboard Serial port 1 and address is 2F8.
3E8/IRQ4	Enable onboard Serial port 1 and address is 3E8.
2E8/IRQ3	Enable onboard Serial port 1 and address is 2E8.
Disabled	Disable onboard Serial port 1.

- **Onboard Serial Port 2**

Auto	BIOS will automatically setup the port 2 address. <b>(Default Value)</b>
3F8/IRQ4	Enable onboard Serial port 2 and address is 3F8.
2F8/IRQ3	Enable onboard Serial port 2 and address is 2F8.
3E8/IRQ4	Enable onboard Serial port 2 and address is 3E8.
2E8/IRQ3	Enable onboard Serial port 2 and address is 2E8.
Disabled	Disable onboard Serial port 2.

- **Onboard Parallel port**

378/IRQ7	Enable onboard LPT port and address is 378/IRQ7. <b>(Default Value)</b>
278/IRQ5	Enable onboard LPT port and address is 278/IRQ5.
3BC/IRQ7	Enable onboard LPT port and address is 3BC/IRQ7.
Disabled	Disable onboard LPT port.

- **Onboard Parallel Mode**

SPP	Using Parallel port as Standard Parallel Port. <b>(Default Value)</b>
EPP	Using Parallel port as Enhanced Parallel Port.
ECP	Using Parallel port as Extended Capabilities Port.
ECP+EPP	Using Parallel port as ECP & EPP mode.

- **Onboard Legacy Audio**

Enabled	Enabled Onboard Legacy Audio. <b>(Default Value)</b>
Disabled	Disabled Onboard Legacy Audio.

- **Sound Blaster**

Enabled	Enabled Sound Blaster.
Disabled	Disabled Sound Blaster. <b>(Default Value)</b>

- **SB I/O Base Address**

220H	Set SB I/O Base Address is 220H. <b>(Default Value)</b> .
280H	Set SB I/O Base Address is 280H.
260H	Set SB I/O Base Address is 260H.
240H	Set SB I/O Base Address is 240H.

- **SB IRQ Select**

IRQ 9 / 5 / 10(Default Value: 5).
-----------------------------------



---

- **SB DMA Select**

DMA 0 / 1 / 2 / 3(Default Value: 1).
--------------------------------------

- **MPU-401**

Enabled	Enabled MPU-401.
Disabled	Disabled MPU-401. (Default Value)

- **MUP-401 I/O Address**

330-333H	Set MUP-401 I/O Address is 330-333H. (Default Value).
300-303H	Set MUP-401 I/O Address is 300-303H.
310-313H	Set MUP-401 I/O Address is 310-313H.
320-323H	Set MUP-401 I/O Address is 320-323H.

- **Game Port (200-207H)**

Disabled	Disabled On Board Game port.
Enabled	Enabled On Board Game port . (Default Value)

## Set Supervisor / User Password

When you select this function, the following message will appear at the center of the screen to assist you in creating a password.

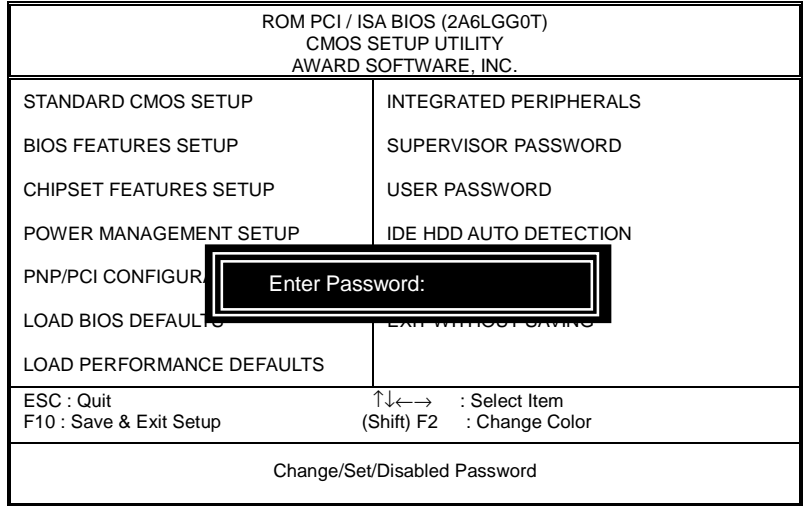

Figure 11: Password Setting

Type the password, up to eight characters, and press <Enter>. The password typed now will clear the previously entered password from CMOS memory. You will be asked to confirm the password. Type the password again and press <Enter>. You may also press <Esc> to abort the selection and not enter a password.

To disable password, just press <Enter> when you are prompted to enter password. A message "PASSWORD DISABLED" will appear to confirm the password being disabled. Once the password is disabled, the system will boot and you can enter Setup freely.

If you select System at "Password Check" Option in BIOS Features Setup Menu, you will be prompted for the password every time the system is rebooted or any time you try to enter Setup Menu. If you select Setup at "Password Check" Option in BIOS Features Setup Menu, you will be prompted only when you try to enter Setup.

**IDE HDD AUTO Detection**

ROM PCI / ISA BIOS (2A6LGG0T) CMOS SETUP UTILITY AWARD SOFTWARE, INC.							
HARD DISKS	TYPE	SIZE	CYLS	HEAD	PRECOMP	LANDZ	SECTOR MODE
Primary Master :							
Select Primary Master Option (N=Skip):N							
OPTION	SIZE	CYLS	HEAD	PRECOMP	LANDZ	SECTOR	MODE
2(Y)	4548	553	255	0	9407	63	LBA
1	4552	9408	15	65535	9407	63	NORMAL
3	4552	588	240	65535	9407	63	LARGE
Note: Some OSes (SCO-UNIX Before V5.0) must use "NORMAL" for installation							
ESC :Skip							

Figure 12: IDE HDD Auto Detection

Type "Y" will accept the H.D.D. parameter reported by BIOS.

Type "N" will keep the old H.D.D. parameter setup. If the hard disk cylinder number is over 1024, then the user can select LBA mode or LARGER mode for DOS partition larger than 528 MB.

## Save & Exit Setup

ROM PCI / ISA BIOS (2A6LGG0T) CMOS SETUP UTILITY AWARD SOFTWARE, INC.	
STANDARD CMOS SETUP	INTEGRATED PERIPHERALS
BIOS FEATURES SETUP	SUPERVISOR PASSWORD
CHIPSET FEATURES SETUP	USER PASSWORD
POWER MANAGEMENT SETUP	IDE HDD AUTO DETECTION
PNP/PCI CONFIGURATION	SAVE & EXIT SETUP
LOAD BIOS DEFAULTS	
LOAD PERFORMANCE OPTIMIZED	
<b>SAVE to CMOS EXIT (Y/N)? Y</b>	
ESC : Quit	↑↓←→ : Select Item
F10 : Save & Exit Setup	(Shift) F2 : Change Color

Figure 13: Save & Exit Setup

Type "Y" will quit the Setup Utility and save the user setup value to RTC CMOS.

Type "N" will return to Setup Utility.

## Exit Without Saving

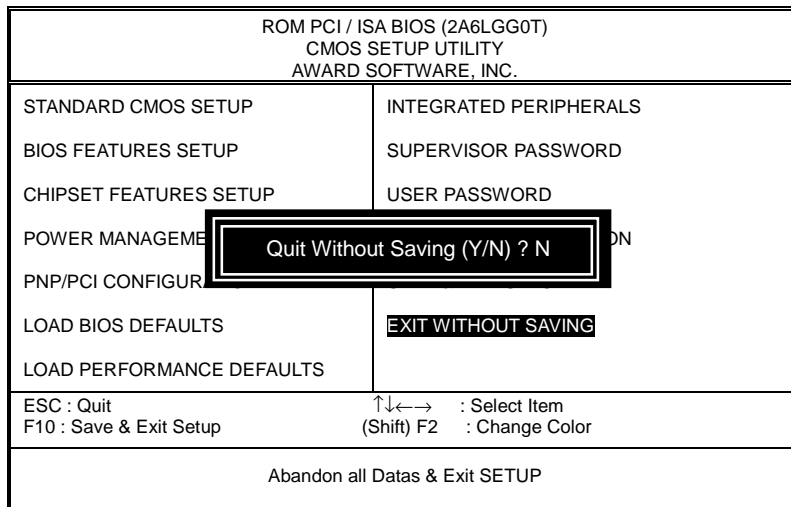

Figure 14: Exit Without Saving

Type "Y" will quit the Setup Utility without saving to RTC CMOS .

Type "N" will return to Setup Utility.

## Appendix

### Appendix A : VIA Chipsets Driver Installation

#### A.VIA 4 in 1 Service Pack Utility:

Insert the support CD that came with your motherboard into your CD-ROM driver or double-click the CD driver icon in My Computer to bring up the screen.

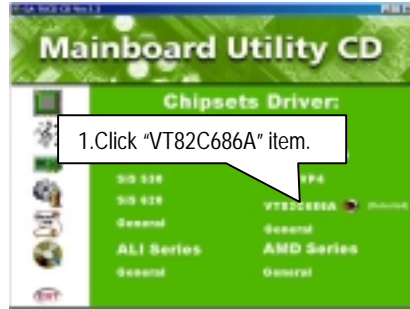

(1)

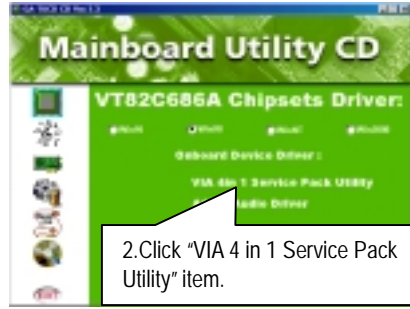

(2)



(3)

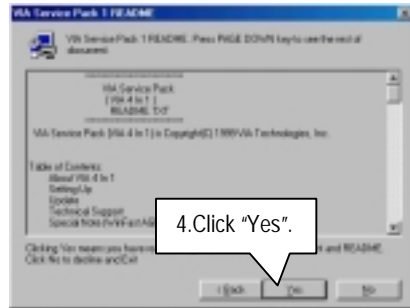

(4)

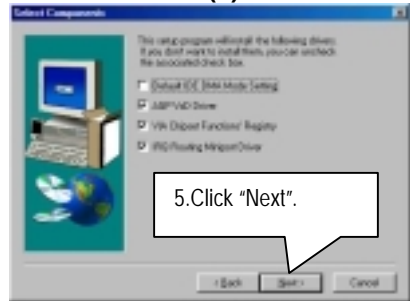

(5)



(6)

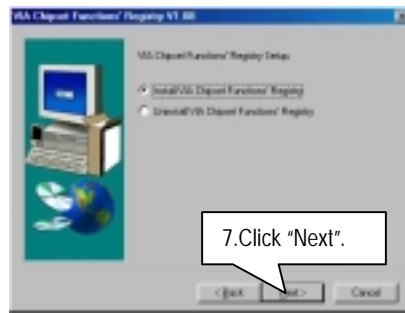

(7)

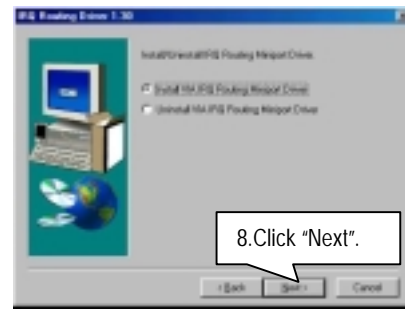

(8)

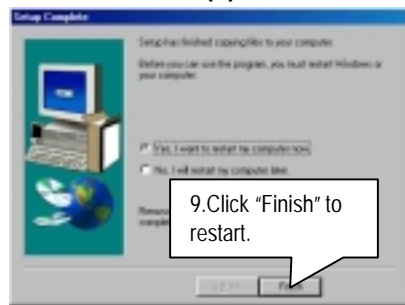

(9)

**B. Hardware Monitor:**

Insert the support CD that came with your motherboard into your CD-ROM driver or double-click the CD driver icon in My Computer to bring up the screen.

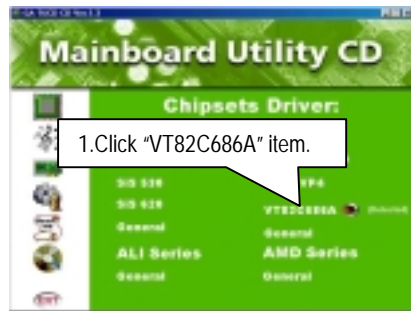

(1)



(2)

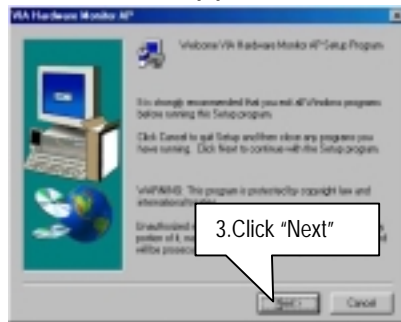

(3)

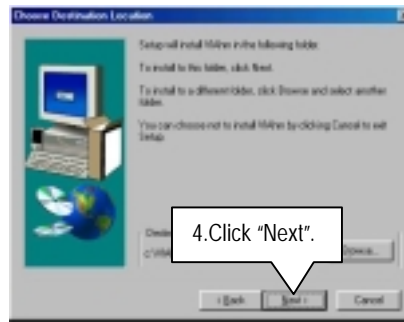

(4)

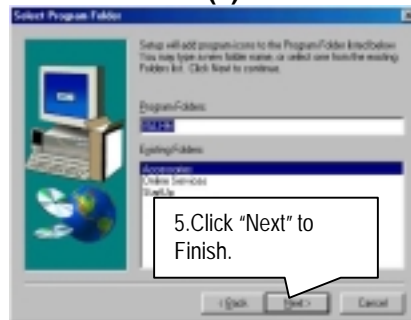

(5)



---

## Appendix B: BIOS Flash Procedure

BIOS update procedure:

- ✓ Please check your BIOS vendor (AMI or AWARD) on the motherboard.
- ✓ It is recommended you copy the AWDFlash.exe or AMIFlash.exe in driver CD (D:\>Utility\BIOSFlash) and the BIOS binary files into the directory you made in your hard disk. 【 i.e:C:\>Utility\ (C:\>Utility : denotes the driver and the directory where you put the flash utilities and BIOS file in.) 】
- ✓ Restart your computer into MS-DOS mode or command prompt only for Win95/98, go into the directory where the new BIOS file are located use the utility AWDFlash.exe or AMIFlash.exe to update the BIOS.
- ✓ Type the following command once you have enter the directory where all the files are located C:\utility\ AWDFlash or AMIFlash <filename of the BIOS binary file intended for flashing>
- ✓ Once the process is finished, reboot the system

● Note: Please download the newest BIOS from our website ([www.gigabyte.com.tw](http://www.gigabyte.com.tw)) or contact your local dealer for the file.

**Appendix C: Acronyms**

Acor.	Meaning
ACPI	Advanced Configuration and Power Interface
POST	Power-On Self Test
LAN	Local Area Network
ECP	Extended Capabilities Port
APM	Advanced Power Management
DMA	Direct Memory Access
MHz	Megahertz
ESCD	Extended System Configuration Data
CPU	Central Processing Unit
SMP	Symmetric Multi-Processing
USB	Universal Serial Bus
OS	Operating System
ECC	Error Checking and Correcting
IDE	Integrated Dual Channel Enhanced
SCI	Special Circumstance Instructions
LBA	Logical Block Addressing
EMC	Electromagnetic Compatibility
BIOS	Basic Input / Output System
SMI	System Management Interrupt
IRQ	Interrupt Request
NIC	Network Interface Card
A.G.P.	Accelerated Graphics Port
S.E.C.C.	Single Edge Contact Cartridge
LED	Light Emitting Diode
EPP	Enhanced Parallel Port
CMOS	Complementary Metal Oxide Semiconductor
I/O	Input / Output
ESD	Electrostatic Discharge
OEM	Original Equipment Manufacturer
SRAM	Static Random Access Memory
VID	Voltage ID
DMI	Desktop Management Interface
MIDI	Musical Interface Digital Interface
IOAPIC	Input Output Advanced Programmable Input Controller
DIMM	Dual Inline Memory Module
DRAM	Dynamic Random Access Memory
PAC	PCI A.G.P. Controller
AMR	Audio Modem Riser

To be continued...

Acor.	Meaning
PCI	Peripheral Component Interconnect
RIMM	Rambus in-line Memory Module
DRM	Dual Retention Mechanism
ISA	Industry Standard Architecture
MTH	Memory Translator Hub
CRIMM	Continuity RIMM