

TABLE OF CONTENTS

1. INTRODUCTION

1.1. PREFACE 1-1
1.2. KEY FEATHERS..... 1-1
1.3. PERFORMANCE LIST 1-2
1.4. BLOCK DIAGRAM..... 1-3
1.5. INTRODUCE THE PENTIUM® II PROCESSOR & AGP..... 1-4
1.6. WHAT IS AGP?..... 1-6

2. SPECIFICATION

2.1. HARDWARE 2-1
2.2. SOFTWARE..... 2-2
2.3. ENVIRONMENT 2-2

3. HARDWARE INSTALLATION

3.1. UNPACKING..... 3-1
3.2. MAINBOARD LAYOUT 3-2
3.3. QUICK REFERENCE FOR JUMPERS & CONNECTORS..... 3-3
3.4. DRAM INSTALLATION 3-6
3.5. CPU SPEED SETUP 3-7
3.6. CMOS RTC & ISA CFG CMOS SRAM..... 3-8
3.7. SPEAKER CONNECTOR INSTALLATION 3-8
3.8. HARDWARE RESET SWITCH CONNECTOR INSTALLATION..... 3-8
3.9. POWER LED CONNECTOR INSTALLATION 3-8
3.10. IDE & ATAPI DEVICE INSTALLATION 3-8

3.11. PERIPHERAL DEVICE INSTALLATION	3-9
3.12. KEYBOARD & PS/2 MOUSE INSTALLATION.....	3-9
4. BIOS CONFIGURATION	
4.1. ENTERING SETUP	4-1
4.2. CONTROL KEYS.....	4-1
4.3. GETTING HELP.....	4-2
4.3.1. Main Menu	4-2
4.3.2. Status Page Setup Menu / Option Page Setup Menu.....	4-2
4.4. THE MAIN MENU	4-2
4.5. STANDARD CMOS SETUP MENU	4-4
4.6. BIOS FEATURES SETUP	4-8
4.7. CHIPSET FEATURES SETUP.....	4-12
4.8. POWER MANAGEMENT SETUP	4-15
4.9. PNP/PCI CONFIGURATION.....	4-19
4.10. LOAD BIOS DEFAULTS	4-21
4.11. LOAD PERFORMANCE DEFAULTS	4-22
4.12. INTEGRATED PERIPHERALS.....	4-23
4.13. SUPERVISOR/USER PASSWORD	4-28
4.14. IDE HDD AUTO DETECTION.....	4-29
4.15. SAVE & EXIT SETUP.....	4-30
4.16. EXIT WITHOUT SAVING	4-31

1. INTRODUCTION

1.1. PREFACE

Welcome to use the **6BXC** motherboard. It is a Pentium® II / Celeron Processor based PC / AT compatible system with AGP / PCI / ISA Bus, and has been designed to be the fastest PC / AT system. There are some new features allow you to operate the system with just the performance you want.

This manual also explains how to install the motherboard for operation, and how to set up your CMOS CONFIGURATION with BIOS SETUP program.

1.2. KEY FEATURES

- ❑ Intel Pentium® II / Celeron Processor based PC / AT compatible main board.
- ❑ Slot 1 supports Pentium® II / Celeron processor running at 233-633 MHz.
- ❑ Intel 440BX chipset, Supports AGP / SDRAM / Ultra DMA/33 IDE / Keyboard and PS/2 Mouse Power On / ACPI features.
- ❑ Supports 3xDIMMs using 3.3V SDRAM DIMM module.
- ❑ Supports 8 MB – 768 MB SDRAM memory on board.
- ❑ Supports ECC or Non-ECC type DRAM module.
- ❑ 1xAGP slot, 4xPCI Bus slots, 3xISA Bus slots.
- ❑ Supports 2 channels Ultra DMA/33 IDE ports for 4 IDE Devices.
- ❑ Supports 2xCOM (16550), 1xLPT (EPP / ECP), 1x1.44MB Floppy port.
- ❑ Supports 2xUSB ports, 1xPS/2 Mouse & 1xPS/2 Keyboard.
- ❑ Licensed AWARD BIOS, 2M bits FLASH ROM.
- ❑ 30.5 cm x 18 cm ATX SIZE form factor, 4 layers PCB.

1.3. PERFORMANCE LIST

The following performance data list is the testing results of some popular benchmark testing programs.

These data are just referred by users, and there is no responsibility for different testing data values gotten by users. (Different Hardware & Software configuration will result in different benchmark testing results.)

- CPU Pentium® II processor
- DRAM 128 MB SDRAM (SEC KM48S8030BT-GH)
- CACHE SIZE 512 KB included in CPU
- DISPLAY GA-601 AGP Display Card (4MB SGRAM)
- STORAGE Onboard IDE (IBM DHEA-38451)
- O.S. Windows NT™4.0
- DRIVER Display Driver at 1024 x 768 x 256 colors x 75Hz.
TRIONES Bus Master IDE Driver 3.70

Processor	Intel Pentium® II	
	333MHz(66x5)	350MHz(100x3.5)
Winbench98		
CPU mark32	864	947
FPU Winmark	1720	1810
Business Disk	1850	1900
Hi-End Disk	4590	4690
Business Graphics	185	204
Hi-End Graphics	207	232
Winstone98		
Business	33.3	34.6
Hi-End	36.9	39.2

1.4. BLOCK DIAGRAM

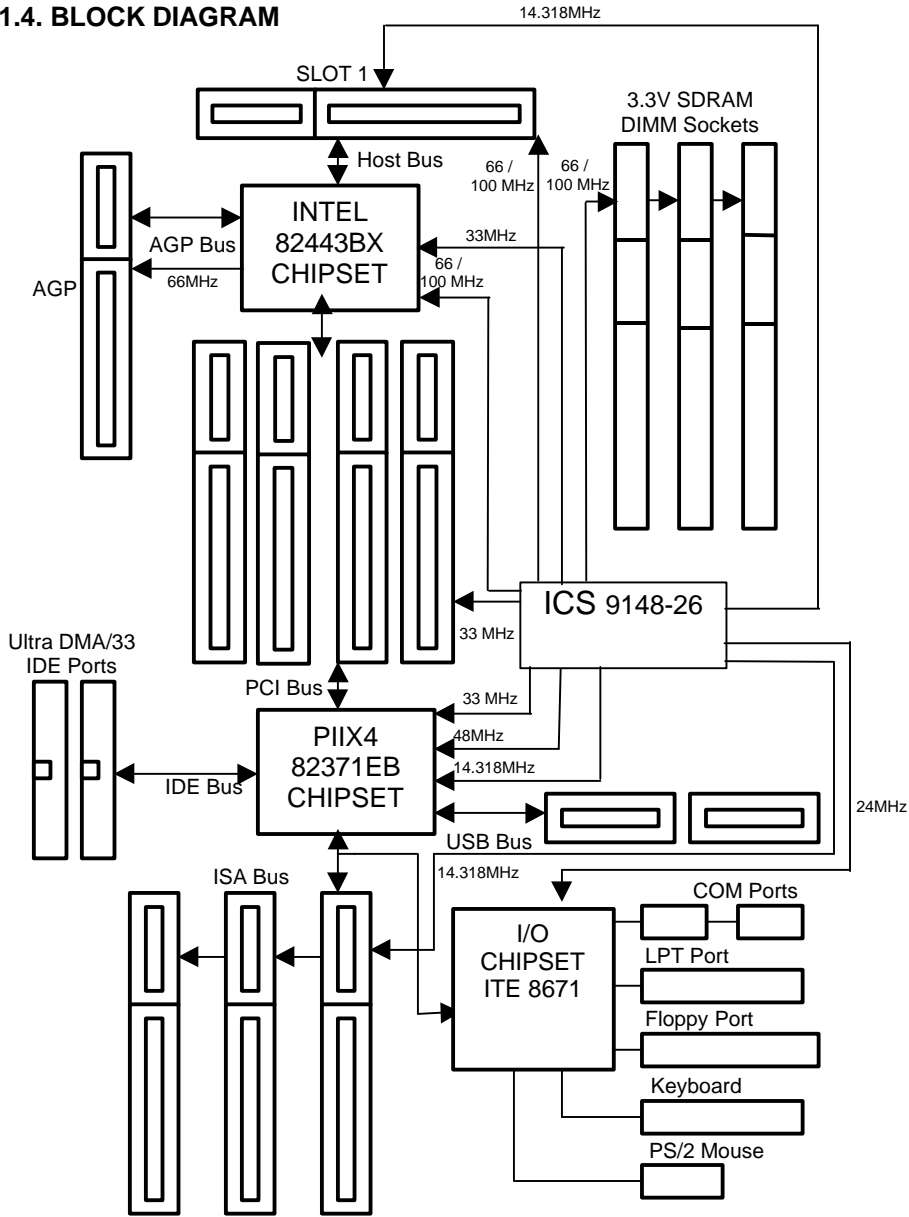

1.5. INTRODUCE THE Pentium® II Processor & AGP



Figure 1:Retention Mechanism & attach Mount



Figure 2:OEM Pentium® II Processor

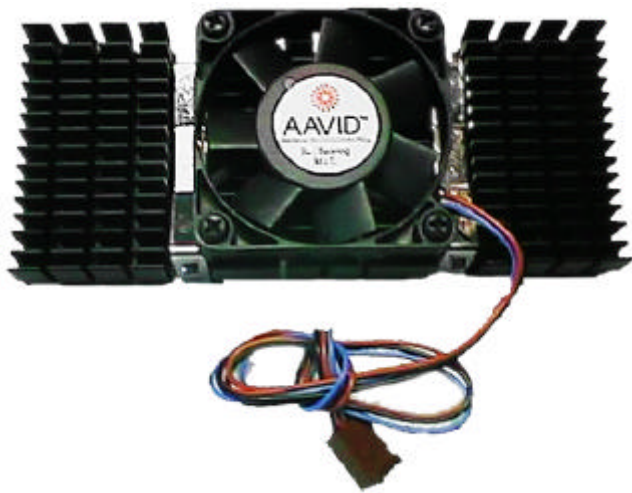

Figure 3:Heatsink / FAN & Heat sink support for OEM Pentium® II Processor

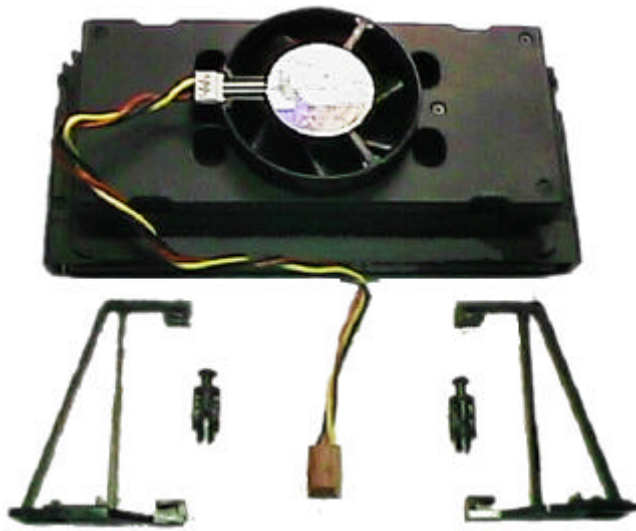

Figure 4:Boxed Pentium® II Processor & Heat sink support

1.6 What is AGP?

The Accelerated Graphics Port (AGP) is a new port on the Host-To-PCI bridge device that supports an AGP port. The main purpose of the AGP port is to provide fast access to system memory.

The AGP port can be used either as fast PCI port (32-bits at 66MHz vs. 32-Bits at 33MHz) or as an AGP port which supports 2x data-rate, a read queue, and side band addressing. When the 2x-data rate is used the port can transmit data at 533MB/sec ($66.6 \times 2 \times 4$). The read-queue can be used to pipeline reads – removing the effects of the reads-latency. Side band addressing can be used to transmit the data address on a separate line in order to speed up the transaction.

2. SPECIFICATION

2.1. HARDWARE

- CPU
 - Pentium® II/ Celeron processor 233 – 633 MHz.
 - 242 pins 66 / 100MHz slot1 on board.
- SPEED
 - 66/100 MHz system speed.
 - 66 MHz AGP bus speed. (2X mode 133MHz)
 - 33 MHz PCI-Bus speed.
 - 8 MHz AT bus speed.
- DRAM MEMORY
 - 3 banks 168 pins DIMM module sockets on board.
 - Use 8 / 16 / 32 / 64 / 128 / 256 MB DIMM module DRAM.
 - 8 ~ 768MB SDRAM.
 - Supports 3.3V SDRAM.
 - Supports ECC or Non-ECC type DRAM.
- CACHE MEMORY
 - 32 KB L1 cache memory included in CPU.
 - 256KB / 512 KB L2 cache memory included in CPU.
 - Supports DIB speed mode for L2 Cache.
- I/O BUS SLOTS
 - 4 33MHz Master / Slave PCI-BUS.
 - 3 8MHz 16 bits ISA BUS.
 - 1 66MHz / 133MHz AGP bus.
- IDE PORTS
 - 2 Ultra DMA/33 Bus Master IDE channels onboard.
(Using IRQ14,15)
 - Support Mode 3,4 IDE & ATAPI CD – ROM.
- I/O PORTS
 - Supports 2 16550 COM ports.
 - Supports 1 EPP/ECP LPT port.
 - Supports 1 1.44 / 2.88 MB Floppy port.
 - Supports 2 USB ports.
 - Supports PS/2 Mouse & PS/2 Keyboard.

- GREEN FUNCTION
 - Suspend mode support.
 - Green switch & ACPI LED support.
 - IDE & Display power down support.
 - Monitor all IRQ / DMA / Display / I/O events.
- BIOS
 - 2M bits FLASH ROM.
 - Supports Plug & Play, DMI Function.
- DIMENSION
 - ATX Form Factor, 4 layers PCB.

2.2. SOFTWARE

- DRIVER
 - INTEL Bus Master IDE Driver.
 - Suspend to HD utility.
 - INTEL Patch 95
- BIOS
 - Licensed AWARD BIOS.
 - AT CMOS Setup, BIOS / Chipset Setup, Green Setup, Hard Disk Utility included.
- O.S.
 - Operation with MS-DOS®, Windows®95, Windows®98, WINDOWS NT™, OS/2, NOVELL and SCO UNIX.

2.3. ENVIRONMENT

- Ambient Temp.
 - 0°C to +50°C (Operating).
- Relative Hum.
 - 0 to +85% (Operating).
- Altitude
 - 0 to 10,000 feet (Operating).
- Vibration
 - 0 to 1,000 Hz.
- Electricity
 - 4.9 V to 5.2 V. (Max. 20A current at 5V.)

3. HARDWARE INSTALLATION

3.1. UNPACKING

The main board package should contain the following:

- The **6BXC** main board.
- The Retention Mechanism & Attach Mount
- USER' S MANUAL for main board.
- Cable set for IDE, Floppy devices.
- Diskette or CD for main board Utility.

The main board contains sensitive electric components, which can be easily damaged by static electricity, so the main board should be left in its original packing until it is installed.

Unpacking and installation should be done on a grounded anti-static mat. The operator should be wearing an anti static wristband, grounded at the same point as the anti-static mat.

Inspect the main board carton for obvious damage. Shipping and handling may cause damage to your board. Be sure there are no shipping and handling damages on the board before proceeding.

After opening the main board carton, extract the system board and place it only on a grounded anti-static surface component side up. Again inspect the board for damage. Press down on all of the socket IC's to make sure that they are properly seated. Do this only on with the board placed on a firm flat surface.

⚠ DO NOT APPLY POWER TO THE BOARD IF IT HAS BEEN DAMAGED.

3.2. MAINBOARD LAYOUT

PCB Rev:1.7

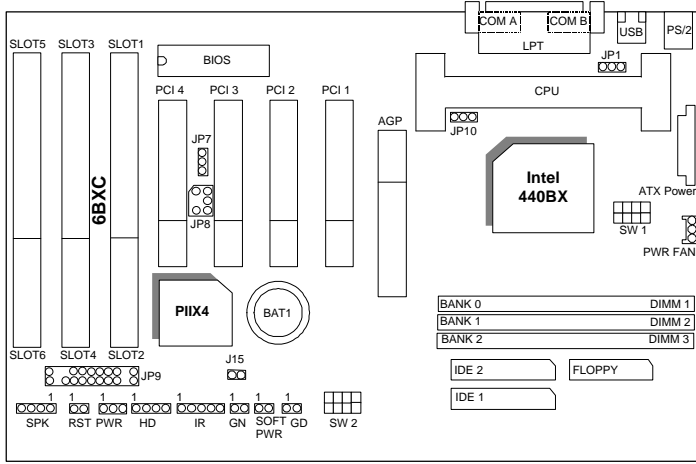

<Figure 3.1>

PCB Rev:1.9

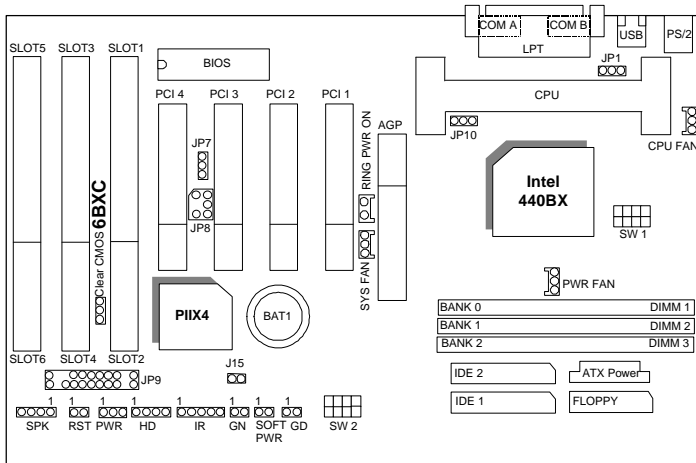

3.3. QUICK REFERENCE FOR JUMPERS & CONNECTORS

◆ I/O Ports Connector	
USB	USB port.
IDE 1	For Primary IDE port.
IDE 2	For Secondary IDE port.
PS/2	For PS/2 Keyboard port.
PS/2	For PS/2 Mouse port.
Floppy	For Floppy port
COM B	For Serial port2 (COM B).[Support Modem ring on.]
COM A	For Serial port1 (COM A).[Support Modem ring on.]
LPT	For LPT port.
ATX Power	For ATX Power connector.

◆ Slot 1
For Pentium® II Processor/Celeron installed

◆ CPU FAN : CPU cooling FAN Power Connector	
Pin No.	Function
1	GND.
2	+12V
3	SENSE

◆ Power FAN : Power FAN Power Connector	
Pin No.	Function
1	GND.
2	+12V
3	SENSE

◆ System FAN : System FAN Power Connector	
Pin No.	Function
1	GND.
2	+12V
3	SENSE

◆ J15 : System After Ac Back	
Open	Soft Off
Short	Full On

◆ JP1 : Keyboard Power On Selection	
Pin No.	Function
1-2	Enabled Keyboard power on.
2-3	Disabled Keyboard power on.(Default)

◆ JP10 : System Acceleration	
1-2 short	For 100MHz Turbo and other frequencies
2-3 short	For 100MHz Normal (Default)

◆ JP7 : Wake on LAN Connector	
Pin No.	Function
1	+5VSB
2	GND
3	CTRL-Signal

◆ JP11 : CLEAR CMOS Function	
Pin No.	Function
1-2 short	CLEAR CMOS Function
2-3 short	Normal Operation.(Default)

◆ Internal Ring Power on	
Pin No.	Function
1	+5VSB
2	GND

◆ JP8 : For PCI Sound Card Connector	
Pin No.	Function
1	Signal
2	GND
3	NC
4	Signal
5	GND

6	Signal
◆ IR: INFRARED Connector (OPTIONAL)	
Pin No.	Function
1	IR DATA OUTPUT
2	GND
3	IR DATA INPUT
4	NC
5	POWER

JP9 : 2*11PIN Jumper

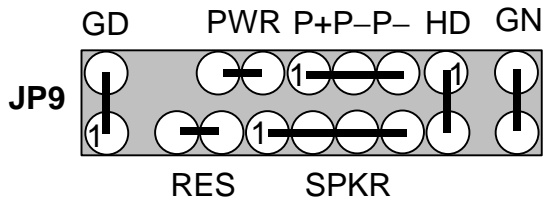

PWR: Soft Power Connector



Open: Normal Operation
Short: Power On/Off

RES: Reset Switch

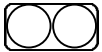

Open: Normal Operation
Short: For Hardware Reset System

P+P- P- : Power LED



PIN 1 : anode (+)
PIN 2 : cathode (-)
PIN 3 : cathode (-)

SPKR: Speaker Connector

PIN 1 : VCC (+)
PIN 2 : NC
PIN 3 : NC
PIN 4 : Data (-)

HD: IDE Hard Disk Active LED

PIN 1: LED anode (+)
PIN 2: LED cathode (-)

GN: Green Function Switch

Open : Normal operation
Short : Entering Green Mode

GD: Green LED

PIN 1 : LED anode (+)
PIN 2 : LED cathode (-)

3.4. DRAM INSTALLATION

The main board can be installed with 8 / 16 / 32 / 64 / 128 / 256 MB 168 pins DIMM module DRAM, and the DRAM speed must be 67~100 MHz for SDRAM when system bus speed is set to 66MHz. When system bus speed is set to 100MHz, 100MHz SDRAM is required. The DRAM memory system on main board consists of bank 0, 1& bank 2.

Since 168 pins DIMM module is 64 bits width, therefore 1 piece of DIMM module may match a 64 bits system. The total memory size is 8 MB ~ 768MB SDRAM. The DRAM installation position refer to Figure 3.1, and notice the Pin 1 of DIMM module must match with the Pin 1 of DIMM socket. Insert the DRAM DIMM module into the DIMM socket at Vertical angle. If there is a wrong direction of Pin 1, the DRAM DIMM module could not be inserted into socket

completely.

3.5. CPU SPEED SETUP

The system bus speed can be set to 66 / 100MHz from the DIP SWITCH (**SW1**). The user can change the DIP SWITCH (**SW2**) selection to set up the CPU speed for different processors. The CPU speed must match with the frequency RATIO and Front Side Bus (FSB) speed. It will cause system hanging up if the frequency RATIO and FSB Speed do not match with the CPU.

DIP SWITCH (SW2)				FREQ. RATIO	EXT.CLK. MHz	AGP	INT.CLK. MHz	CPU Type
1	2	3	4	(SW2)	(SW1)			
OFF	OFF	ON	ON	3.5	66	66	233	Pentium® II 233 MHz (Celeron 233MHz)
ON	ON	OFF	ON	4	66	66	266	Pentium® II 266 MHz (Celeron 266MHz)
OFF	ON	OFF	ON	4.5	66	66	300	Pentium® II 300 MHz (Celeron 300MHz)
ON	OFF	OFF	ON	5	66	66	333	Pentium® II 333 MHz (Celeron 333MHz)
OFF	OFF	OFF	ON	5.5	66	66	366	Pentium® II 366 MHz (Celeron 366MHz)
ON	ON	ON	OFF	6	66	66	400	Pentium® II 400 MHz (Celeron 400MHz)
OFF	ON	ON	OFF	6.5	66	66	433	Pentium® II 433 MHz (Celeron 433MHz)
OFF	OFF	ON	ON	3.5	100	66	350	Pentium® II 350 MHz
ON	ON	OFF	ON	4	100	66	400	Pentium® II 400 MHz
OFF	ON	OFF	ON	4.5	100	66	450	Pentium® II 450 MHz
ON	OFF	OFF	ON	5	100	66	500	Pentium® II 500 MHz
OFF	OFF	OFF	ON	5.5	100	66	550	Pentium® II 550 MHz
ON	ON	ON	OFF	6	100	66	600	Pentium® II 600 MHz
OFF	ON	ON	OFF	6.5	100	66	650	Pentium® II 650 MHz

⚠ The CPU is a sensitive electric component and it can be easily damaged by static electricity, so users must keep it away from metal

surface when the CPU is installed onto main board.

3.6. CMOS RTC & ISA CFG CMOS SRAM

There're RTC & CMOS SRAM on board; they have a power supply from external battery to keep the DATA inviolate & effective. The RTC is a REAL-TIME CLOCK device, which provides the DATE & TIME to system. The CMOS SRAM is used for keeping the information of system configuration, so the system can automatically boot OS every time. Since the lifetime of internal battery is 5 years, the user can change a new Battery to replace old one after it cannot work.

- ⚠ Danger of explosion if battery is incorrectly replaced.
- ⚠ Replace only with the same or equivalent type recommended by the manufacturer.
- ⚠ Dispose of used batteries according to the manufacturer's instructions.

3.7. SPEAKER CONNECTOR INSTALLATION

There is a speaker in AT system for sound purpose. The 4 - Pins connector **SPKR** is used to connect speaker.

3.8. HARDWARE RESET SWITCH CONNECTOR INSTALLATION

The RESET switch on panel provides users with HARDWARE RESET function. The system will do a cold start after the RESET switch is pushed and released by user. The RESET switch is a 2 PIN connector and should be installed to **RST** on main board.

3.9. POWER LED CONNECTOR INSTALLATION

System has Power LED lamp on the panel of case. The Power LED will light on off or flash to indicate which step on the system. The connector should be connected to **PWR** of main board in correct direction.

3.10. IDE & ATAPI DEVICE INSTALLATION

There are two-Enhanced PCI IDE ports (**IDE1**, **IDE2**) on board, which following ATAPI standard SPEC. Any one IDE port can connected to two ATAPI devices (IDE Hard Disk, CD-ROM & Tape Driver), so total four ATAPI devices can exist in a system. The **HD** is the active LED port for ATAPI devices.

3.11. PERIPHERAL DEVICE INSTALLATION

After the I/O device installation and jumpers setup, the main board can be mounted into the case and fixed by screw. To complete the main board installation, the peripheral device could be installed now. The basic system needs a display interface card. If the PCI - Bus device is to be installed in the system, any one of four PCI - Bus slots can be used.

3.12. KEYBOARD & PS/2 MOUSE INSTALLATION

The main board supports PS/2 Mouse (**J2**). The BIOS will auto detect whether the PS/2 Mouse is installed or not & assign IRQ12 for PS/2 Mouse port if it is installed. After installing the peripheral device, the user should check everything again, and prepare to power-on the system.