

# GA-X99-UD7 WIFI

## User's Manual

Rev. 1002

12ME-X99U7WF-1002R



For more product details, please visit GIGABYTE's website.



To reduce the impacts on global warming, the packaging materials of this product are recyclable and reusable. GIGABYTE works with you to protect the environment.

**Declaration of Conformity**

We, Manufacturer/Importer,  
**G.B.T. Technology Trading GmbH**  
 Address: **Bullenkoppel 16, 22047 Hamburg, Germany**  
 Declares that the product  
 Product Type: **Motherboard**  
 Product Name: **GA-X99-UD7 WIFI**

conforms with the essential requirements of the following directives:

**2004/108/EC EMC Directive:**  
 Conduction & Radiated Emissions: EN 55022:2010  
 Immunity: EN 55024:2010  
 Power-line harmonics: EN 61000-3-2:2006+A2:2009  
 Power-line flicker: EN 61000-3-3:2008

**2006/95/EC LVD Directive**  
 Safety: EN60950-1:2006+A11:2009+A12:2011

**1999/5/EC R&TTE Directive**  
 Technical Requirements: EN 300 328 v1.8.1  
 EN 301 489-1 V1.9.2, EN 301 489-17 v2.2.1  
 EN 301 893 V1.7.1

**2011/65/EU RoHS Directive**  
 Restriction of use of certain substances in electronic equipment: This product does not contain any of the restricted substances listed in Annex II, in concentrations and applications banned by the directive.

**CE marking**



Signature: Timmy Huang

(Date) Date: Aug. 15, 2014 Name: Timmy Huang

**DECLARATION OF CONFORMITY**

Per FCC Part 2 Section 2.1077(a)



**Responsible Party Name: G.B.T. INC. (U.S.A.)**

**Address: 17358 Railroad Street  
 City of Industry, CA 91748**

**Phone/Fax No: (626) 854-9338/ (626) 854-9326**

hereby declares that the product

**Product Name: Motherboard**

**Model Number: GA-X99-UD7 WIFI**

Conforms to the following specifications:

FCC Part 15, Subpart B, Section 15.107(a) and Section 15.109 (a), Class B Digital Device

**Supplementary Information:**

This device complies with part 15 of the FCC Rules. Operation is subject to the following two conditions: (1) This device may not cause harmful and (2) this device must accept any interference received, including that may cause undesired operation.

Representative Person's Name: ERIC LU

Signature: Eric Lu

Date: Aug. 15, 2014

**Wireless Module Country Approvals:**

United States FCC: PD97260NGU Canada IC: 100DM-7260NG	European Union 	Nigeria "Connection and use of this communications equipment is permitted by the Nigerian Communications Commission"	Taiwan CCAH13LP0330T4 AN: CCAH13LP0350T0 NB: CCAH13LP0370T3 BN: CCAH13LP0390T9
Algeria 301/IR/AGR/PC/ARPT/2013	India NR-ETA / 536 AN: NR-ETA / 549 NB: NR-ETA / 550 BN: NR-ETA / 551	Pakistan PTA Approved Model	United Arab Emirates ERO105795/13
Australia & New-Zealand 	Japan 003-130045 D130021003 5.15~5.35GHz indoor use only	Philippines ESD-1307220C	Ukraine 10094.001216-13 NB: 10094.001213-13
Brazil Agência Nacional de Telecomunicações 0644-13-2198 (01)07898355950278 Este equipamento opera em caráter secundário, isto é, não tem direito a proteção contra interferência prejudicial, mesmo de estações do mesmo tipo, e não pode causar interferência a sistemas operando em caráter primário.	Jordan TRC/LPD/2013/112	Qatar ICTQATAR/RT/2013/R-3411	Uruguay URSEC: 211/FR/2013
Chile 2092/DFRS08617/F-50	Mexico RCPIN7213-642 AN: RCPIN7213-640 NB: RCPIN7213-641 BN: RCPIN7213-0644	Serbia 	
China CMIIT ID: 2013AJ0751(M) AN: CMIIT ID:2013AJ0755 NB: CMIIT ID:2013AJ0756 BN: CMIIT ID:2013AJ0753	Morocco MR 7945 ANRT 2013	Singapore Complies with IDA Standards DB 02941	
		South Korea KCC-CRM-INT-7260NGW AN: KCC-CRM-INT-7260NGWANB NB: KCC-CRM-INT-7260NGWNB BN: KCC-CRM-INT-7260NGWNB	

See the latest safety and regulatory documents at GIGABYTE's website.



## **Copyright**

© 2016 GIGA-BYTE TECHNOLOGY CO., LTD. All rights reserved.

The trademarks mentioned in this manual are legally registered to their respective owners.

## **Disclaimer**

Information in this manual is protected by copyright laws and is the property of GIGABYTE. Changes to the specifications and features in this manual may be made by GIGABYTE without prior notice.

No part of this manual may be reproduced, copied, translated, transmitted, or published in any form or by any means without GIGABYTE's prior written permission.

## **Documentation Classifications**

In order to assist in the use of this product, GIGABYTE provides the following types of documentations:

- For quick set-up of the product, read the Quick Installation Guide included with the product.
- For detailed product information, carefully read the User's Manual.

For product-related information, check on our website at: <http://www.gigabyte.com>

## **Identifying Your Motherboard Revision**

The revision number on your motherboard looks like this: "REV: X.X." For example, "REV: 1.0" means the revision of the motherboard is 1.0. Check your motherboard revision before updating motherboard BIOS, drivers, or when looking for technical information.

Example:

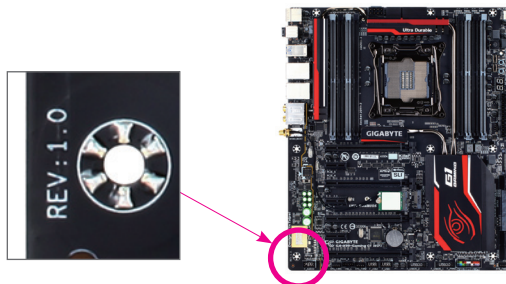

# Table of Contents

Box Contents .....	6
Optional Items .....	6
GA-X99-UD7 WIFI Motherboard Layout.....	7
GA-X99-UD7 WIFI Motherboard Block Diagram .....	8
Chapter 1 Hardware Installation .....	9
1-1 Installation Precautions .....	9
1-2 Product Specifications.....	10
1-3 Installing the CPU and CPU Cooler .....	13
1-3-1 Installing the CPU.....	13
1-3-2 Installing the CPU Cooler .....	15
1-4 Installing the Memory .....	16
1-4-1 4 Channel Memory Configuration .....	16
1-4-2 Installing a Memory .....	17
1-5 Installing an Expansion Card .....	18
1-6 Setting up AMD CrossFire™/NVIDIA® SLI™ Configuration .....	19
1-7 Back Panel Connectors.....	21
1-8 Installing the I/O Shield .....	23
1-9 Onboard Buttons, Switches, and LEDs.....	24
1-10 Internal Connectors.....	26
Chapter 2 BIOS Setup .....	37
2-1 Startup Screen .....	38
2-2 The Main Menu .....	39
2-3 M.I.T. ....	42
2-4 System Information .....	54
2-5 BIOS Features .....	55
2-6 Peripherals .....	58
2-7 Chipset.....	60
2-8 Power Management.....	63
2-9 Save & Exit.....	65
Chapter 3 Configuring SATA Hard Drive(s).....	67
3-1 Configuring SATA Controllers.....	67
3-2 Installing the SATA RAID/AHCI Driver and Operating System.....	79

Chapter 4 Drivers Installation.....	83
4-1 Chipset Drivers.....	83
4-2 Application Software .....	84
4-3 Information .....	84
Chapter 5 Unique Features.....	85
5-1 BIOS Update Utilities .....	85
5-1-1 Updating the BIOS with the Q-Flash Utility.....	85
5-1-2 Updating the BIOS with the @BIOS Utility .....	88
5-1-3 Using Q-Flash Plus.....	89
5-2 APP Center .....	90
5-2-1 EasyTune.....	91
5-2-2 System Information Viewer.....	92
5-2-3 EZ Setup.....	93
5-2-4 Fast Boot .....	96
5-2-5 Smart TimeLock.....	97
5-2-6 Smart Recovery 2.....	98
5-2-7 USB Blocker .....	100
5-2-8 Ambient LED .....	101
5-2-9 V-Tuner .....	102
5-2-10 Smart Switch .....	103
5-2-11 Cloud Station Server .....	104
Chapter 6 Appendix.....	111
6-1 Configuring Audio Input and Output.....	111
6-1-1 Configuring 2/4/5.1/7.1-Channel Audio.....	111
6-1-2 Configuring S/PDIF Out.....	113
6-1-3 Configuring Microphone Recording .....	114
6-1-4 Using the Sound Recorder .....	116
6-2 Troubleshooting.....	117
6-2-1 Frequently Asked Questions .....	117
6-2-2 Troubleshooting Procedure .....	118
6-3 Debug LED Codes .....	120
Regulatory Statements.....	124
Contact Us .....	128

## Box Contents

- GA-X99-UD7 WIFI motherboard
- Motherboard driver disk
- Wireless module driver disk
- User's Manual
- Quick Installation Guide
- Six SATA cables
- I/O Shield
- One 2-Way SLI bridge connector
- Two 3-Way SLI bridge connectors (GC-3SLI-X99 and GC-3SLI)
- One 4-Way SLI bridge connector
- One 2-Way CrossFire bridge connector
- One antenna
- One 1 to 3 power cable (2x4 ATX 12V)

The box contents above are for reference only and the actual items shall depend on the product package you obtain. The box contents are subject to change without notice.

## Optional Items

- 2-port USB 2.0 bracket (Part No. 12CR1-1UB030-6\*R)
- eSATA bracket (Part No. 12CF1-3SATPW-4\*R)
- 3.5" Front Panel with 2 USB 3.0/2.0 ports (Part No. 12CR1-FPX582-2\*R)

# GA-X99-UD7 WIFI Motherboard Layout

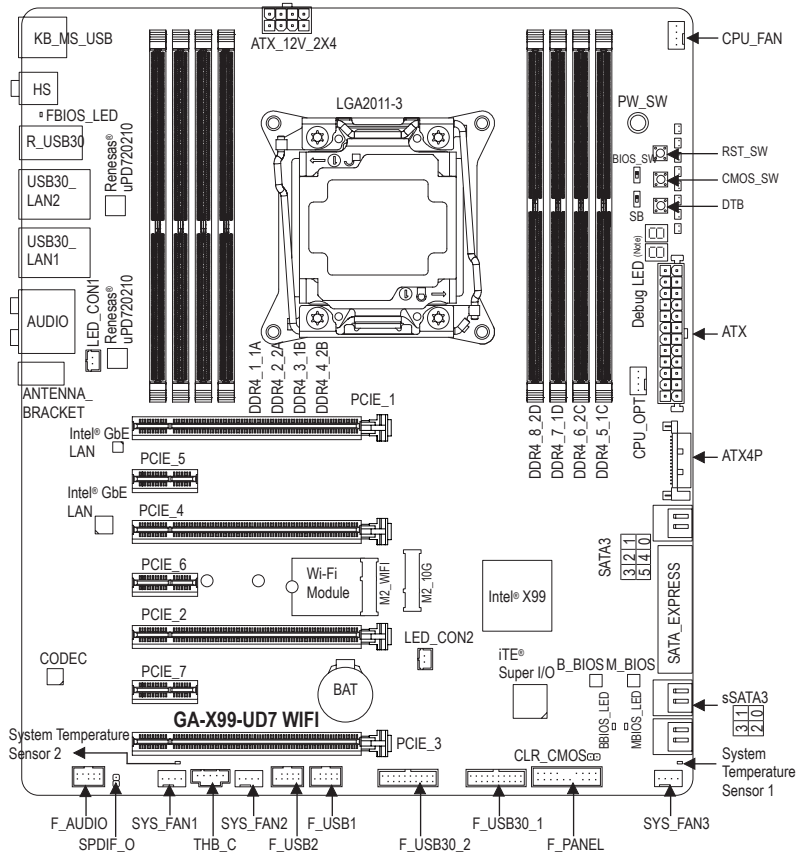

(Note) For debug code information, please refer to Chapter 6.

# GA-X99-UD7 WIFI Motherboard Block Diagram

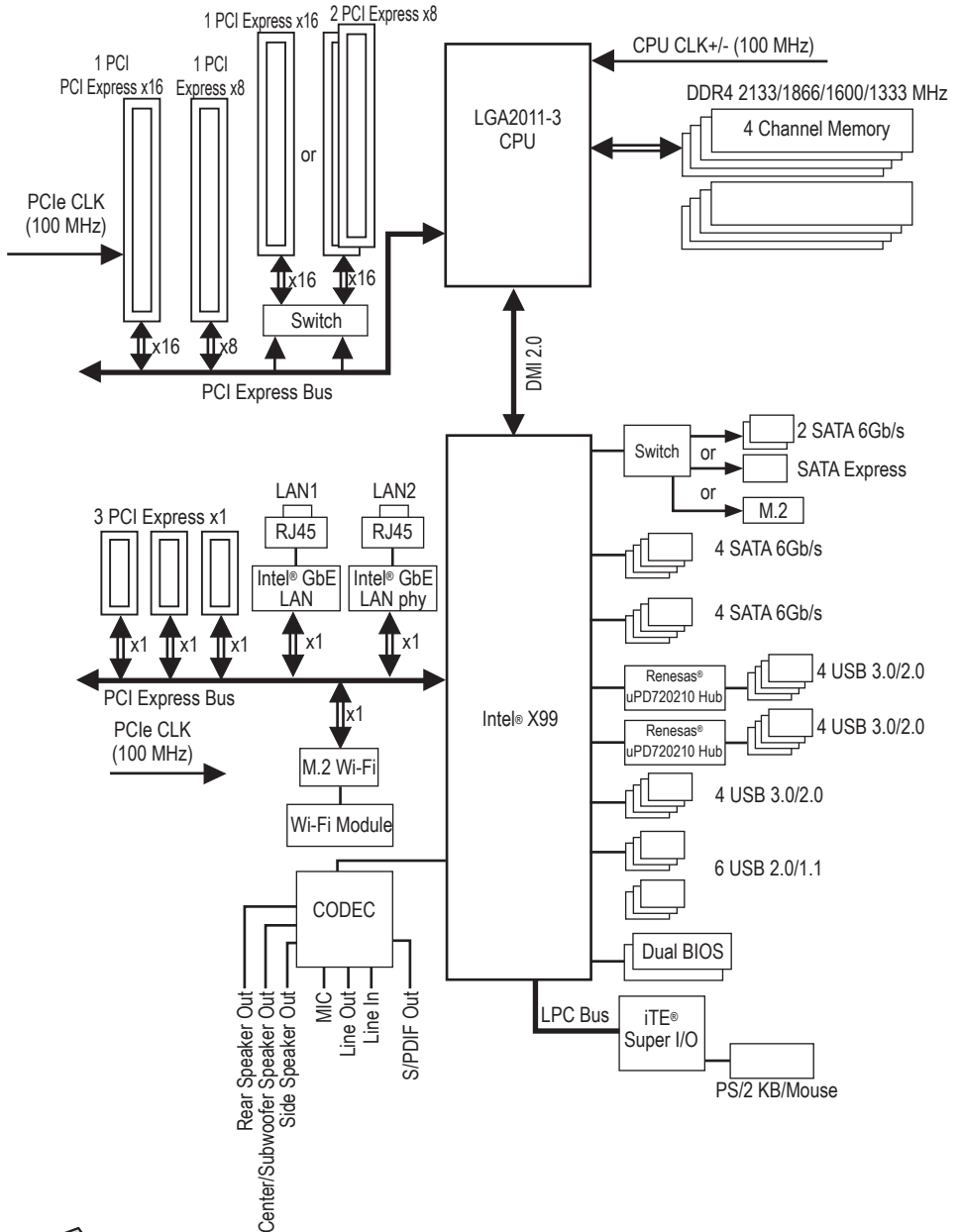

 For detailed product information/limitation(s), refer to "1-2 Product Specifications."









# Chapter 1 Hardware Installation

## 1-1 Installation Precautions





The motherboard contains numerous delicate electronic circuits and components which can become damaged as a result of electrostatic discharge (ESD). Prior to installation, carefully read the user's manual and follow these procedures:









- Prior to installation, make sure the chassis is suitable for the motherboard.
- Prior to installation, do not remove or break motherboard S/N (Serial Number) sticker or warranty sticker provided by your dealer. These stickers are required for warranty validation.
- Always remove the AC power by unplugging the power cord from the power outlet before installing or removing the motherboard or other hardware components.
- When connecting hardware components to the internal connectors on the motherboard, make sure they are connected tightly and securely.
- When handling the motherboard, avoid touching any metal leads or connectors.
- It is best to wear an electrostatic discharge (ESD) wrist strap when handling electronic components such as a motherboard, CPU or memory. If you do not have an ESD wrist strap, keep your hands dry and first touch a metal object to eliminate static electricity.
- Prior to installing the motherboard, please have it on top of an antistatic pad or within an electrostatic shielding container.
- Before unplugging the power supply cable from the motherboard, make sure the power supply has been turned off.
- Before turning on the power, make sure the power supply voltage has been set according to the local voltage standard.
- Before using the product, please verify that all cables and power connectors of your hardware components are connected.
- To prevent damage to the motherboard, do not allow screws to come in contact with the motherboard circuit or its components.
- Make sure there are no leftover screws or metal components placed on the motherboard or within the computer casing.
- Do not place the computer system on an uneven surface.
- Do not place the computer system in a high-temperature environment.
- Turning on the computer power during the installation process can lead to damage to system components as well as physical harm to the user.
- If you are uncertain about any installation steps or have a problem related to the use of the product, please consult a certified computer technician.

## 1-2 Product Specifications

 CPU	<ul style="list-style-type: none"> <li>Support for Intel® Core™ i7 processors in the LGA2011-3 package (Go to GIGABYTE's website for the latest CPU support list.)</li> <li>L3 cache varies with CPU</li> </ul>
 Chipset	<ul style="list-style-type: none"> <li>Intel® X99 Express Chipset</li> </ul>
 Memory	<ul style="list-style-type: none"> <li>8 x DDR4 DIMM sockets supporting up to 128 GB of system memory               <ul style="list-style-type: none"> <li>* Due to a Windows 32-bit operating system limitation, when more than 4 GB of physical memory is installed, the actual memory size displayed will be less than the size of the physical memory installed.</li> </ul> </li> <li>4 channel memory architecture</li> <li>Support for DDR4 2133/1866/1600/1333 MHz memory modules</li> <li>Support for non-ECC memory modules</li> <li>Support for Extreme Memory Profile (XMP) memory modules</li> <li>Support for RDIMM 1Rx8 memory modules (operate in non-ECC mode) (Go to GIGABYTE's website for the latest supported memory speeds and memory modules.)</li> </ul>
 Audio	<ul style="list-style-type: none"> <li>Realtek® ALC1150 codec</li> <li>High Definition Audio</li> <li>2/4/5.1/7.1-channel</li> <li>Support for S/PDIF Out</li> </ul>
 LAN	<ul style="list-style-type: none"> <li>2 x Intel® GbE LAN chips (10/100/1000 Mbit)</li> </ul>
 Wireless Communication Module	<ul style="list-style-type: none"> <li>Wi-Fi 802.11 a/b/g/n/ac, supporting 2.4/5 GHz Dual-Band</li> <li>Bluetooth 4.0, 3.0+HS, 2.1+EDR</li> <li>Support for 11ac wireless standard and up to 867 Mbps data rate               <ul style="list-style-type: none"> <li>* Actual data rate may vary depending on environment and equipment.</li> </ul> </li> </ul>
 Expansion Slots	<ul style="list-style-type: none"> <li>2 x PCI Express x16 slots, running at x16 (PCIE_1, PCIE_2)               <ul style="list-style-type: none"> <li>* For optimum performance, if only one PCI Express graphics card is to be installed, be sure to install it in the PCIE_1 slot; if you are installing two PCI Express graphics cards, it is recommended that you install them in the PCIE_1 and PCIE_2 slots.</li> </ul> </li> <li>2 x PCI Express x16 slots, running at x8 (PCIE_3, PCIE_4)               <ul style="list-style-type: none"> <li>* The PCIE_4 slot shares bandwidth with the PCIE_1 slot. When the PCIE_4 slot is populated, the PCIE_1 slot will operate at up to x8 mode.</li> <li>* When an i7-5820K CPU is installed, the PCIE_2 slot operates at up to x8 mode and the PCIE_3 operates at up to x4 mode.</li> </ul> </li> </ul> <p>(All PCI Express x16 slots conform to PCI Express 3.0 standard.)</p> <ul style="list-style-type: none"> <li>3 x PCI Express x1 slots (The PCI Express x1 slots conform to PCI Express 2.0 standard.)</li> <li>1 x M.2 Socket 1 connector for the wireless communication module (M2_WIFI)</li> </ul>
 Multi-Graphics Technology	<ul style="list-style-type: none"> <li>Support for 4-Way/3-Way/2-Way AMD CrossFire™/NVIDIA® SLI™ technology               <ul style="list-style-type: none"> <li>* The 4-Way NVIDIA® SLI™ configuration is not supported when an i7-5820K CPU is installed. To set up a 3-Way SLI configuration, refer to "1-6 Setting up AMD CrossFire™/NVIDIA® SLI™ Configuration."</li> </ul> </li> </ul>
 Storage Interface	<ul style="list-style-type: none"> <li>Chipset:           <ul style="list-style-type: none"> <li>- 1 x M.2 Socket 3 connector (M2_10G)</li> <li>- 1 x SATA Express connector</li> <li>- 6 x SATA 6Gb/s connectors (SATA3 0~5)</li> <li>- Support for RAID 0, RAID 1, RAID 5, and RAID 10               <ul style="list-style-type: none"> <li>* Only AHCI mode is supported when an M.2 PCIe SSD or a SATA Express device is installed.</li> </ul> </li> </ul> </li> </ul>



	Storage Interface	<p>(M2_10G, SATA Express, and SATA3 4/5 connectors can only be used one at a time. The SATA3 4/5 connectors will become unavailable when an M.2 SSD is installed in the M2_10G connector.)</p> <ul style="list-style-type: none"> <li>◆ Chipset: <ul style="list-style-type: none"> <li>- 4 x SATA 6Gb/s connectors (sSATA3 0~3), supporting IDE and AHCI modes only</li> </ul> </li> </ul> <p>(An operating system installed on the SATA3 0~5 connectors cannot be used on the sSATA3 0~3 connectors.)</p>
	USB	<ul style="list-style-type: none"> <li>◆ Chipset: <ul style="list-style-type: none"> <li>- 4 x USB 3.0/2.0 ports (available through the internal USB headers)</li> <li>- 6 x USB 2.0/1.1 ports (2 ports on the back panel, 4 ports available through the internal USB headers)</li> </ul> </li> <li>◆ Chipset + 2 Renesas® uPD720210 USB 3.0 Hubs: <ul style="list-style-type: none"> <li>- 8 x USB 3.0/2.0 ports on the back panel</li> </ul> </li> </ul>
	Internal Connectors	<ul style="list-style-type: none"> <li>◆ 1 x 24-pin ATX main power connector</li> <li>◆ 1 x 8-pin ATX 12V power connector</li> <li>◆ 1 x PCIe power connector</li> <li>◆ 1 x SATA Express connector</li> <li>◆ 10 x SATA 6Gb/s connectors</li> <li>◆ 1 x M.2 Socket 3 connector</li> <li>◆ 1 x CPU fan header</li> <li>◆ 1 x water cooling fan header (CPU_OPT)</li> <li>◆ 3 x system fan headers</li> <li>◆ 1 x heatsink LED power connector</li> <li>◆ 1 x I/O shield audio LED power connector</li> <li>◆ 1 x front panel header</li> <li>◆ 1 x front panel audio header</li> <li>◆ 2 x USB 3.0/2.0 headers</li> <li>◆ 2 x USB 2.0/1.1 headers</li> <li>◆ 1 x Thunderbolt add-in card connector</li> <li>◆ 1 x Clear CMOS jumper</li> <li>◆ 1 x power button</li> <li>◆ 1 x reset button</li> <li>◆ 1 x Clear CMOS button</li> <li>◆ 1 x Direct to BIOS button</li> <li>◆ 2 x BIOS switches</li> <li>◆ Voltage Measurement Points</li> </ul>
	Back Panel Connectors	<ul style="list-style-type: none"> <li>◆ 1 x PS/2 keyboard/mouse port</li> <li>◆ 1 x CPU overclocking button</li> <li>◆ 1 x Fast Boot button</li> <li>◆ 1 x Clear CMOS button</li> <li>◆ 8 x USB 3.0/2.0 ports</li> <li>◆ 2 x USB 2.0/1.1 ports</li> <li>◆ 2 x RJ-45 ports</li> <li>◆ 2 x SMA antenna connectors (2T2R)</li> </ul>

 Back Panel Connectors	<ul style="list-style-type: none"> <li>◆ 1 x optical S/PDIF Out connector</li> <li>◆ 5 x audio jacks (Center/Subwoofer Speaker Out, Rear Speaker Out, Line In, Line Out, Mic In)</li> </ul>
 I/O Controller	<ul style="list-style-type: none"> <li>◆ iTE® I/O Controller Chip</li> </ul>
 Hardware Monitor	<ul style="list-style-type: none"> <li>◆ System voltage detection</li> <li>◆ CPU/System/Chipset temperature detection</li> <li>◆ CPU/CPU OPT/System fan speed detection</li> <li>◆ CPU/System/Chipset overheating warning</li> <li>◆ CPU/CPU OPT/System fan fail warning</li> <li>◆ CPU/CPU OPT/System fan speed control</li> </ul> <p style="margin-left: 20px;">* Whether the fan speed control function is supported will depend on the cooler you install.</p>
 BIOS	<ul style="list-style-type: none"> <li>◆ 2 x 128 Mbit flash</li> <li>◆ Use of licensed AMI UEFI BIOS</li> <li>◆ Support for DualBIOS™</li> <li>◆ Support for Q-Flash Plus</li> <li>◆ PnP 1.0a, DMI 2.7, WfM 2.0, SM BIOS 2.7, ACPI 5.0</li> </ul>
 Unique Features	<ul style="list-style-type: none"> <li>◆ Support for APP Center <ul style="list-style-type: none"> <li>* Available applications in APP Center may differ by motherboard model. Supported functions of each application may also differ depending on motherboard specifications.</li> <li>- @BIOS</li> <li>- Ambient LED</li> <li>- EasyTune</li> <li>- EZ Setup</li> <li>- Fast Boot</li> <li>- Cloud Station</li> <li>- ON/OFF Charge</li> <li>- Smart TimeLock</li> <li>- Smart Recovery 2</li> <li>- System Information Viewer</li> <li>- USB Blocker</li> <li>- V-Tuner</li> </ul> </li> <li>◆ Support for Q-Flash</li> <li>◆ Support for Smart Switch</li> <li>◆ Support for Xpress Install</li> </ul>
 Bundled Software	<ul style="list-style-type: none"> <li>◆ Norton® Internet Security (OEM version)</li> <li>◆ Intel® Smart Response Technology</li> <li>◆ cFosSpeed</li> </ul>
 Operating System	<ul style="list-style-type: none"> <li>◆ Support for Windows 8.1/8/7</li> </ul>
 Form Factor	<ul style="list-style-type: none"> <li>◆ E-ATX Form Factor; 30.5cm x 25.9cm</li> </ul>

\* GIGABYTE reserves the right to make any changes to the product specifications and product-related information without prior notice.

\* Please visit the [Support & Downloads\Utility](#) page on GIGABYTE's website to check the supported operating system(s) for the software listed in the "Unique Features" and "Bundled Software" columns.

## 1-3 Installing the CPU and CPU Cooler



Read the following guidelines before you begin to install the CPU:

- Make sure that the motherboard supports the CPU.  
(Go to GIGABYTE's website for the latest CPU support list.)
- Always turn off the computer and unplug the power cord from the power outlet before installing the CPU to prevent hardware damage.
- Locate the pin one of the CPU. The CPU cannot be inserted if oriented incorrectly. (Or you may locate the notches on both sides of the CPU and alignment keys on the CPU socket.)
- Apply an even and thin layer of thermal grease on the surface of the CPU.
- Do not turn on the computer if the CPU cooler is not installed, otherwise overheating and damage of the CPU may occur.
- Set the CPU host frequency in accordance with the CPU specifications. It is not recommended that the system bus frequency be set beyond hardware specifications since it does not meet the standard requirements for the peripherals. If you wish to set the frequency beyond the standard specifications, please do so according to your hardware specifications including the CPU, graphics card, memory, hard drive, etc.

### 1-3-1 Installing the CPU

- A. Locate the alignment keys on the motherboard CPU socket and the notches on the CPU.

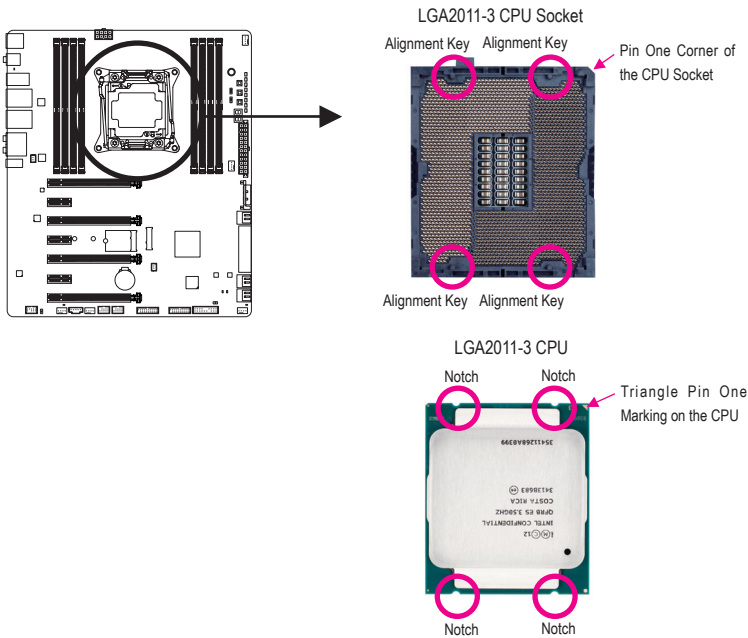

B. Follow the steps below to correctly install the CPU into the motherboard CPU socket.



- Before installing the CPU, make sure to turn off the computer and unplug the power cord from the power outlet to prevent damage to the CPU.
- To protect the socket contacts, do not remove the protective plastic cover unless the CPU is inserted into the CPU socket. Save the cover properly and replace it if the CPU is removed.

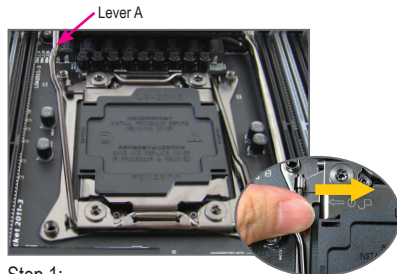

Step 1:  
Push the lever closest to the "unlock" mark "☐" (below referred as lever A) down and away from the socket to release it.

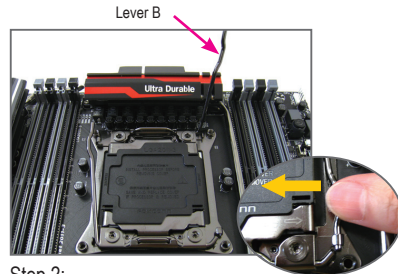

Step 2:  
Push the lever closest to the "lock" mark "☒" (below referred as lever B) down and away from the socket. Then lift the lever.



Step 3:  
Gently press lever A to allow the load plate to rise. Open the load plate. Note: DO NOT touch the socket contacts after the load plate is opened.

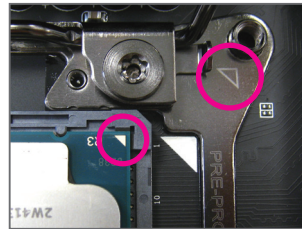

Step 4:  
Hold the CPU with your thumb and index fingers. Align the CPU pin one mark (triangle) with the triangle mark on metal socket frame and carefully insert the CPU into the socket vertically.

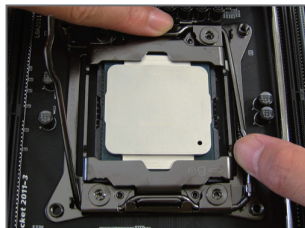

Step 5:  
Once the CPU is properly inserted, carefully replace the load plate. Then secure lever B under its retention tab.



Step 6:  
Finally, secure lever A under its retention tab to complete the installation of the CPU. Then carefully remove the plastic cover. Save it properly and always replace it when the CPU is not installed.

### 1-3-2 Installing the CPU Cooler

Refer to the steps below to correctly install the CPU cooler on the motherboard. (Actual installation process may differ depending on the CPU cooler to be used. Refer to the user's manual for your CPU cooler.)



**Step 1:**  
Apply an even and thin layer of thermal grease on the surface of the installed CPU.

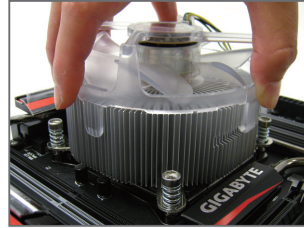

**Step 2:**  
Place the cooler atop the CPU, aligning the four mounting screws with the mounting holes on the ILM.

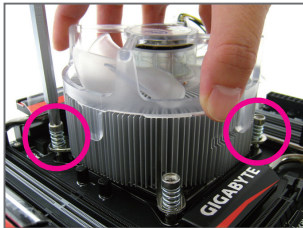

**Step 3:**  
Use one hand to hold the cooler and the other to tighten the screws in a diagonal sequence with a screw driver. Begin tightening a screw with a few turns and repeat with the screw diagonally opposite the one you just tightened. Then do the same to the other pair. Next, fully tighten the four screws.

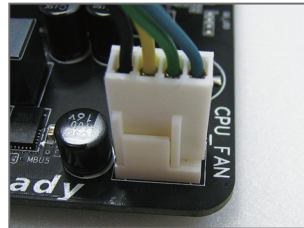

**Step 4:**  
Finally, attach the power connector of the CPU cooler to the CPU fan header (CPU\_FAN) on the motherboard.



Use extreme care when removing the CPU cooler because the thermal grease/tape between the CPU cooler and CPU may adhere to the CPU. Inadequately removing the CPU cooler may damage the CPU.

## 1-4 Installing the Memory



Read the following guidelines before you begin to install the memory:

- Make sure that the motherboard supports the memory. It is recommended that memory of the same capacity, brand, speed, and chips be used. (Go to GIGABYTE's website for the latest supported memory speeds and memory modules.)
- Always turn off the computer and unplug the power cord from the power outlet before installing the memory to prevent hardware damage.
- Memory modules have a foolproof design. A memory module can be installed in only one direction. If you are unable to insert the memory, switch the direction.

### 1-4-1 4 Channel Memory Configuration

This motherboard provides eight DDR4 memory sockets and supports 4 Channel Technology. After the memory is installed, the BIOS will automatically detect the specifications and capacity of the memory. The eight DDR4 memory sockets are divided into four channels and each channel has two memory sockets as following:

- ▶▶ Channel A: DDR4\_1\_1A, DDR4\_2\_2A
- ▶▶ Channel B: DDR4\_3\_1B, DDR4\_4\_2B
- ▶▶ Channel C: DDR4\_5\_1C, DDR4\_6\_2C
- ▶▶ Channel D: DDR4\_7\_1D, DDR4\_8\_2C

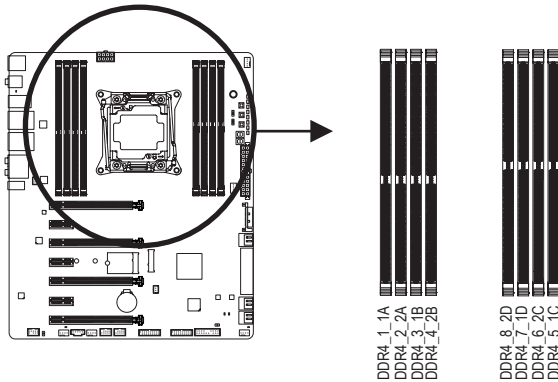

▶▶ Refer to the table below for memory installation according to the number of the memory modules you want to install:

	DDR4_1_1A	DDR4_2_2A	DDR4_3_1B	DDR4_4_2B	DDR4_8_2D	DDR4_7_1D	DDR4_6_2C	DDR4_5_1C
1 Module	--	--	●	--	--	--	--	--
2 Modules	--	--	●	--	--	--	--	--
4 Modules	●	--	●	--	--	●	--	●
6 Modules	●	--	●	●	●	●	--	●
8 Modules	●	●	●	●	●	●	●	●

Note 1: When installing the memory, make sure to begin with the first socket of each channel, such as DDR4\_1\_1A, DDR4\_3\_1B, DDR4\_5\_1C, and DDR4\_7\_1D.

Note 2: If you are using a RDIMM memory, make sure it is a 1Rx8 one.

Note 3: To ensure memory compatibility, we do not recommend that you install RDIMM and UDIMM memory at the same time.

## 1-4-2 Installing a Memory



Before installing a memory module, make sure to turn off the computer and unplug the power cord from the power outlet to prevent damage to the memory module. DDR4 and DDR3 DIMMs are not compatible to each other or DDR2 DIMMs. Be sure to install DDR4 DIMMs on this motherboard.

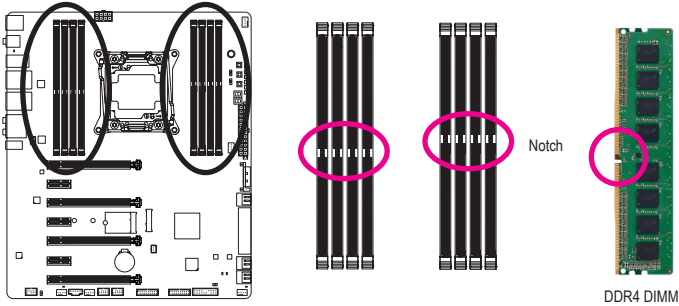

A DDR4 memory module has a notch, so it can only fit in one direction. Follow the steps below to correctly install your memory modules in the memory sockets.

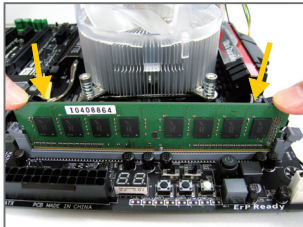

### Step 1:

Note the orientation of the memory module. Spread the retaining clip at the right end of the memory socket. Place the memory module on the socket. As indicated in the picture on the left, place your fingers on the top edge of the memory, push down on the memory and insert it vertically into the memory socket.

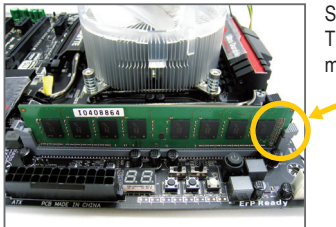

### Step 2:

The clip at the right end of the socket will snap into place when the memory module is securely inserted.

## 1-5 Installing an Expansion Card



Read the following guidelines before you begin to install an expansion card:

- Make sure the motherboard supports the expansion card. Carefully read the manual that came with your expansion card.
- Always turn off the computer and unplug the power cord from the power outlet before installing an expansion card to prevent hardware damage.

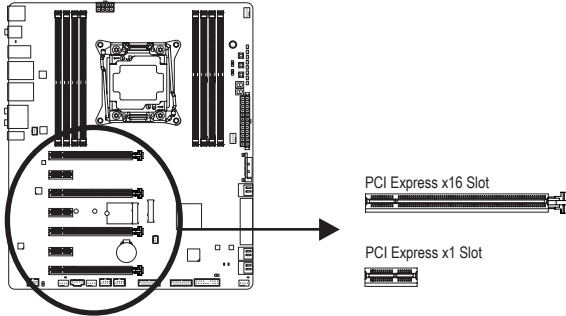

Follow the steps below to correctly install your expansion card in the expansion slot.

1. Locate an expansion slot that supports your card. Remove the metal slot cover from the chassis back panel.
2. Align the card with the slot, and press down on the card until it is fully seated in the slot.
3. Make sure the metal contacts on the card are completely inserted into the slot.
4. Secure the card's metal bracket to the chassis back panel with a screw.
5. After installing all expansion cards, replace the chassis cover(s).
6. Turn on your computer. If necessary, go to BIOS Setup to make any required BIOS changes for your expansion card(s).
7. Install the driver provided with the expansion card in your operating system.

Example: Installing and Removing a PCI Express Graphics Card:



- Installing a Graphics Card:  
Gently push down on the top edge of the card until it is fully inserted into the PCI Express slot. Make sure the card is securely seated in the slot and does not rock.



- Removing the Card:  
Gently push back on the lever on the slot and then lift the card straight out from the slot.



## 1-6 Setting up AMD CrossFire™/NVIDIA® SLI™ Configuration

### A. System Requirements

- Windows 8.1/8/7 operating system
- A CrossFire/SLI-supported motherboard with two or more PCI Express x16 slots and correct driver
- CrossFire/SLI-ready graphics cards of identical brand and chip and correct driver  
(Current GPUs that support 3-Way/4-Way CrossFire technology include the ATI Radeon™ HD 3800, HD 4800, HD 5800 series, and AMD Radeon™ HD 6800, HD 6900, HD 7800, and HD 7900 series. Current GPUs that support 3-Way/4-Way SLI technology include the NVIDIA® 8800 GTX, 8800 Ultra, 9800 GTX, GTX 260, GTX 280, GTX 470, GTX 480, GTX 570, GTX 580, GTX 590, and GTX 600 series.) For the latest GPU support information, please refer to the AMD/NVIDIA® website.) <sup>(Note 1)</sup>
- CrossFire <sup>(Note 2)</sup>/SLI bridge connectors
- A power supply with sufficient power is recommended (Refer to the manual of your graphics cards for the power requirement)

### B. Connecting the Graphics Cards

Step 1:

Observe the steps in "1-5 Installing an Expansion Card" and install CrossFire/SLI graphics cards on the PCI Express x16 slots.

Step 2:

Insert the CrossFire<sup>(Note 2)</sup>/SLI bridge connectors in the CrossFire/SLI gold edge connectors on top of the cards.

Step 3:

Plug the display cable into the graphics card on the PCIE\_1 slot.

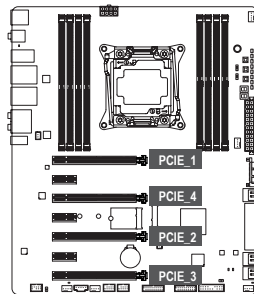

▶▶ Refer to the table below when an i7-5960X or i7-5930K CPU is installed:

	1 Graphics Card	2 Graphics Cards	3 Graphics Cards	4 Graphics Cards
PCIE_1	●	●	●	●
PCIE_4	--	--	--	●
PCIE_2	--	●	●	●
PCIE_3	--	--	●	●



To set up a 3-Way SLI configuration, use the GC-3SLI-X99 bridge connector.

▶▶ Refer to the table below for setting up a 3-Way SLI configuration with an i7-5820K CPU. Make sure to use the GC-3SLI bridge connector.

	1 Graphics Card	2 Graphics Cards	3 Graphics Cards
PCIE_1	●	●	●
PCIE_4	--	--	●
PCIE_2	--	●	●
PCIE_3	--	--	--

(Note 1) The 4-Way SLI configuration is not supported when an i7-5820K CPU is installed.

(Note 2) The bridge connector(s) may be needed or not depending on your graphics cards.



- Procedure and driver screen for enabling CrossFire/SLI technology may differ by graphics cards and driver version. Refer to the manual that came with your graphics cards for more information about enabling CrossFire/SLI technology.
- When two or more graphics cards are installed, we recommend that you connect the SATA power cable from the power supply to the ATX4P connector to ensure system stability.

## C. Configuring the Graphics Card Driver

### C-1. To Enable CrossFire Function

After installing the graphics card driver in the operating system, go to the **AMD Catalyst Control Center**. Browse to **Performance\AMD CrossFire™** and ensure the **Enable AMD CrossFireX** check box is selected. If your system has more than two CrossFire cards, select the GPU combination you want to use and click **Apply**. (Available combination options are dependent on the number of graphics cards.)

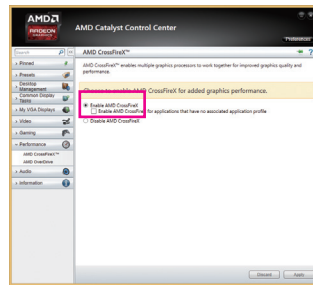

### C-2. To Enable SLI Function

After installing the graphics card driver in the operating system, go to the **NVIDIA Control Panel**. Browse to the **Configure SLI, Surround, Physx** screen and ensure **Maximize 3D performance** is enabled.

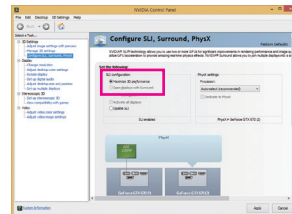

## 1-7 Back Panel Connectors

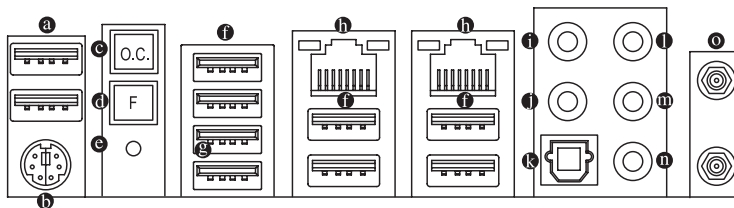

### a USB 2.0/1.1 Port

The USB port supports the USB 2.0/1.1 specification. Use this port for USB devices such as a USB keyboard/mouse, USB printer, USB flash drive and etc.

### b PS/2 Keyboard/Mouse Port

Use this port to connect a PS/2 mouse or keyboard.

### c CPU Overclocking Button

Press this button to overclock your CPU. To return to the defaults, press this button again.

### d Fast Boot Button

Press this button down to enable the fast boot function to shorten OS boot time. (Make sure to set this button before system power-on; otherwise, it will take effect at next boot.)

### e Clear CMOS Button

Use this button to clear the CMOS values (e.g. BIOS configuration) and reset the CMOS values to factory defaults when needed.

### f USB 3.0/2.0 Port

The USB 3.0 port supports the USB 3.0 specification and is compatible to the USB 2.0/1.1 specification. Use this port for USB devices such as a USB keyboard/mouse, USB printer, USB flash drive and etc.

### g USB 3.0/2.0 Port (White)

The USB 3.0 port supports the USB 3.0 specification and is compatible to the USB 2.0/1.1 specification. Use this port for USB devices such as a USB keyboard/mouse, USB printer, USB flash drive and etc. Before using Q-Flash Plus, make sure to insert the USB flash drive into this port first.

### h RJ-45 LAN Port (LAN1/2)

The Gigabit Ethernet LAN port provides Internet connection at up to 1 Gbps data rate. The following describes the states of the LAN port LEDs.

Connection/ Speed LED	Activity LED	Connection/Speed LED:		Activity LED:	
		State	Description	State	Description
		Orange	1 Gbps data rate	Blinking	Data transmission or receiving is occurring
		Green	100 Mbps data rate	On	No data transmission or receiving is occurring
		Off	10 Mbps data rate		

### i Center/Subwoofer Speaker Out Jack (Orange)

Use this audio jack to connect center/subwoofer speakers in a 5.1/7.1-channel audio configuration.

### j Rear Speaker Out Jack (Black)

This jack can be used to connect front speakers in a 4/5.1/7.1-channel audio configuration.



- When removing the cable connected to a back panel connector, first remove the cable from your device and then remove it from the motherboard.
- When removing the cable, pull it straight out from the connector. Do not rock it side to side to prevent an electrical short inside the cable connector.

### ⑬ **Optical S/PDIF Out Connector**

This connector provides digital audio out to an external audio system that supports digital optical audio. Before using this feature, ensure that your audio system provides an optical digital audio in connector.

### ⑭ **Line In Jack (Blue)**

The line in jack. Use this audio jack for line in devices such as an optical drive, walkman, etc.

### ⑮ **Line Out Jack (Green)**

The line out jack. This jack supports audio amplifying function. For better sound quality, it is recommended that you connect your headphone/speaker to this jack (actual effects may vary by the device being used). Use this audio jack for a headphone or 2-channel speaker. This jack can be used to connect front speakers in a 4/5.1/7.1-channel audio configuration.

### ⑯ **Mic In Jack (Pink)**

The Mic in jack. Microphones must be connected to this jack.



The audio jacks can be reconfigured to perform different functions via the audio software (supported functions may vary based on hardware specification). If you install a Side Speaker, you need to retask other audio jack to be Side Speaker out. Only microphones still **MUST** be connected to the default Mic in jack. Refer to the instructions on setting up a 2/4/5.1/7.1-channel audio configuration in Chapter 6, "Configuring 2/4/5.1/7.1-Channel Audio."

### ⑰ **SMA Antenna Connectors (2T2R)**

Use this connector to connect an antenna.



Tighten the antenna cables to the antenna connectors and then move the antenna to a place where the signal is good.

## 1-8 Installing the I/O Shield

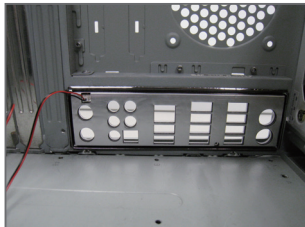

Step 1:  
Install the included I/O shield into the chassis. (For actual installation, please refer to the user guide for your chassis.)

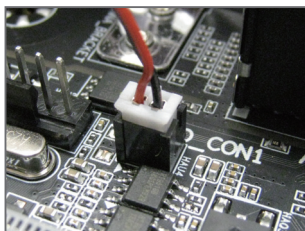

Step 2:  
Place the motherboard into the chassis, aligning the back panel connectors with the installed I/O shield. Connect the power cable from the I/O shield to the LED\_CON1 connector on the motherboard.



For how to turn on/off the I/O shield LED indicators, refer to the instructions on in Chapter 2, "BIOS Setup," "Peripherals," or Chapter 5, "Unique Features," "APP Center\Ambient LED."

## 1-9 Onboard Buttons, Switches, and LEDs

### BIOS Switches and BIOS LED Indicators

The BIOS switch (BIOS\_SW) allows users to easily select a different BIOS for boot up or overlocking, helping to reduce BIOS failure during overlocking. The SB switch allows enabling or disabling of the Dual BIOS function. The LED indicator (M BIOS\_LED/B BIOS\_LED) shows which BIOS is active.

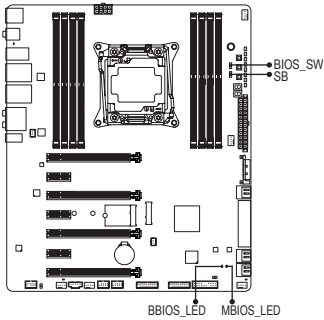

#### BIOS\_SW



1: Main BIOS (Boot from the main BIOS)



2: Backup BIOS (Boot from the backup BIOS)



1: Dual BIOS



2: Single BIOS

#### BIOS LED Indicators:

M BIOS\_LED (The main BIOS is active)

B BIOS\_LED (The backup BIOS is active)

### Quick Buttons

This motherboard has four quick buttons: Power, Reset, Clear CMOS, and Direct to BIOS. The power button and reset button allow users to quickly turn on/off or reset the computer in an open-case environment when they want to change hardware components or conduct hardware testing. Use this button to clear the BIOS configuration and reset the CMOS values to factory defaults when needed. The Direct to BIOS button helps users more easily to directly enter the BIOS at any time before rebooting the system. (Pressing this button during the POST process allows you to immediately enter BIOS Setup. Enter BIOS Setup directly on next boot if the button is pressed after the POST process.)

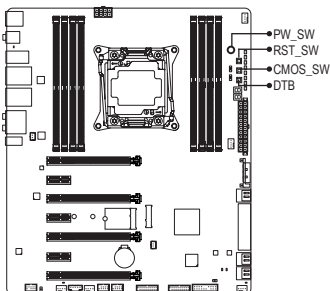

PW\_SW: Power Button

RST\_SW: Reset Button

CMOS\_SW: Clear CMOS Button

DTB: Direct to BIOS Button



- Always turn off your computer and unplug the power cord from the power outlet before clearing the CMOS values.
- NOTE: Do not use the clear CMOS button when the system is on, or the system may shutdown and data loss or damage may occur.
- After system restart, go to BIOS Setup to load factory defaults (select Load Optimized Defaults) or manually configure the BIOS settings (refer to Chapter 2, "BIOS Setup," for BIOS configurations).

## Voltage Measurement Points

Use a multimeter to measure the following motherboard voltages. You can employ following way to measure component voltages.

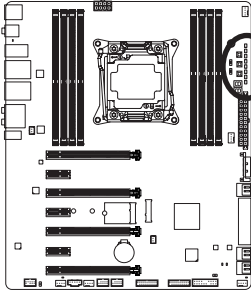

- Pin 1 → VRIN
- Pin 1 → DIMM\_A
- Pin 1 → DIMM\_B
- Pin 1 → DDRVTT\_A
- Pin 1 → DDRVTT\_B
- Pin 1 → VPP25\_A
- Pin 1 → VPP25\_B
- Pin 1 → PCHV

Pin No.	Definition
1	Power
2	GND

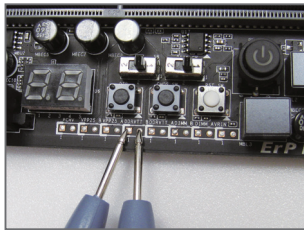

Steps:

Connect the red lead of the multimeter to the pin 1 (Power) of a voltage measurement point and the black lead to the pin 2 (ground).

## 1-10 Internal Connectors

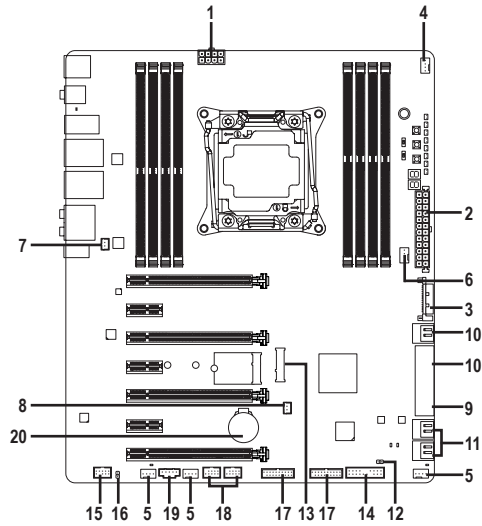

1)	ATX_12V_2X4	11)	sSATA3 0/1/2/3
2)	ATX	12)	CLR_CMOS
3)	ATX4P	13)	M2_10G
4)	CPU_FAN	14)	F_PANEL
5)	SYS_FAN1/2/3	15)	F_AUDIO
6)	CPU_OPT	16)	SPDIF_O
7)	LED_CON1	17)	F_USB30_1/F_USB30_2
8)	LED_CON2	18)	F_USB1/F_USB2
9)	SATA_EXPRESS	19)	THB_C
10)	SATA3 0/1/2/3/4/5	20)	BAT



Read the following guidelines before connecting external devices:

- First make sure your devices are compliant with the connectors you wish to connect.
- Before installing the devices, be sure to turn off the devices and your computer. Unplug the power cord from the power outlet to prevent damage to the devices.
- After installing the device and before turning on the computer, make sure the device cable has been securely attached to the connector on the motherboard.



## 1/2) ATX\_12V\_2X4/ATX (2x4 12V Power Connector and 2x12 Main Power Connector)

With the use of the power connector, the power supply can supply enough stable power to all the components on the motherboard. Before connecting the power connector, first make sure the power supply is turned off and all devices are properly installed. The power connector possesses a foolproof design. Connect the power supply cable to the power connector in the correct orientation.

The 12V power connector mainly supplies power to the CPU. If the 12V power connector is not connected, the computer will not start.



To meet expansion requirements, it is recommended that a power supply that can withstand high power consumption be used (500W or greater). If a power supply is used that does not provide the required power, the result can lead to an unstable or unbootable system.

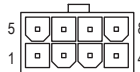
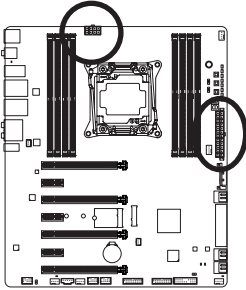

ATX\_12V\_2X4

ATX\_12V\_2X4:

Pin No.	Definition
1	GND (Only for 2x4-pin 12V)
2	GND (Only for 2x4-pin 12V)
3	GND
4	GND
5	+12V (Only for 2x4-pin 12V)
6	+12V (Only for 2x4-pin 12V)
7	+12V
8	+12V

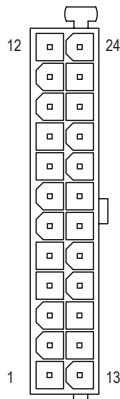

ATX

ATX:

Pin No.	Definition	Pin No.	Definition
1	3.3V	13	3.3V
2	3.3V	14	-12V
3	GND	15	GND
4	+5V	16	PS_ON (soft On/Off)
5	GND	17	GND
6	+5V	18	GND
7	GND	19	GND
8	Power Good	20	NC
9	5VSB (stand by +5V)	21	+5V
10	+12V	22	+5V
11	+12V (Only for 2x12-pin ATX)	23	+5V (Only for 2x12-pin ATX)
12	3.3V (Only for 2x12-pin ATX)	24	GND (Only for 2x12-pin ATX)



When you overclock the CPU, make sure to connect one end of the included 1 to 3 power cable to the ATX\_12V\_2X4 power connector and the other three to the power supply to ensure the system is provided with enough power.

### 3) ATX4P (PCIe Power Connector)

The power connector provide auxiliary power to the onboard PCI Express x16 slots. When two or more graphics cards are installed, we recommend that you connect the SATA power cable(s) from the power supply to the ATX4P connector to ensure system stability.

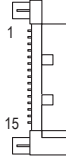
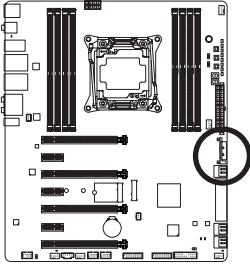

Pin No.	Definition
1	NC
2	NC
3	NC
4	GND
5	GND
6	GND
7	VCC
8	VCC
9	VCC
10	GND
11	GND
12	GND
13	+12V
14	+12V
15	+12V

### 4/5) CPU\_FAN/SYS\_FAN1/2/3 (Fan Headers)

All fan headers on this motherboard are 4-pin. Most fan headers possess a foolproof insertion design. When connecting a fan cable, be sure to connect it in the correct orientation (the black connector wire is the ground wire). The speed control function requires the use of a fan with fan speed control design. For optimum heat dissipation, it is recommended that a system fan be installed inside the chassis.

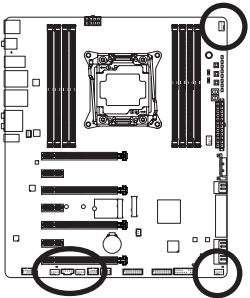

CPU\_FAN



SYS\_FAN1/2/3

CPU\_FAN:

Pin No.	Definition
1	GND
2	+12V
3	Sense
4	Speed Control

SYS\_FAN1/2/3:

Pin No.	Definition
1	GND
2	Speed Control
3	Sense
4	VCC



- Be sure to connect fan cables to the fan headers to prevent your CPU and system from overheating. Overheating may result in damage to the CPU or the system may hang.
- These fan headers are not configuration jumper blocks. Do not place a jumper cap on the headers.

### 6) CPU\_OPT (Water Cooling CPU Fan Header)

The fan header is 4-pin and possesses a foolproof insertion design. When connecting a fan cable, be sure to connect it in the correct orientation (the black connector wire is the ground wire). The speed control function requires the use of a fan with fan speed control design.

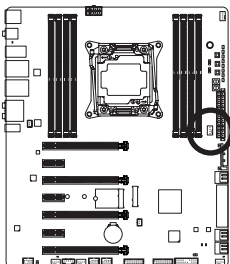

Pin No.	Definition
1	GND
2	Speed Control
3	Sense
4	VCC

### 7) LED\_CON1 (I/O Shield Audio LED Power Connector)

The power connector provides power to the LEDs on the I/O shield on the motherboard back panel.

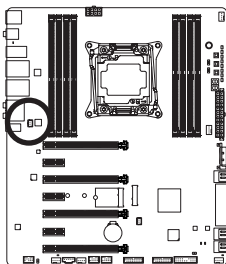

Pin No.	Definition
1	VCC
2	GND

### 8) LED\_CON2 (Heatsink LED Power Connector)

The power connector provides power to the LEDs on the Chipset heatsink.

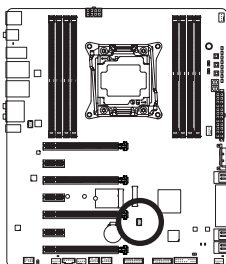

Pin No.	Definition
1	VCC
2	GND

## 9) SATA\_EXPRESS (SATA Express Connector)

The SATA Express connector supports a single SATA Express device.

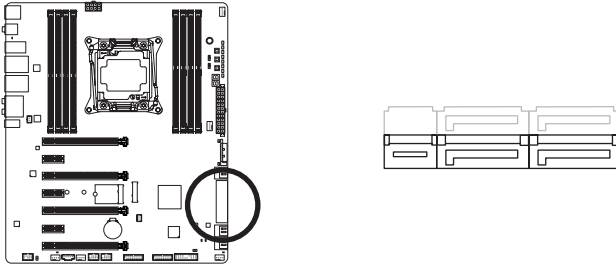

M2\_10G, SATA Express, and SATA3 4/5 connectors can only be used one at a time. The SATA3 4/5 connectors will become unavailable when an M.2 SSD is installed.

## 10) SATA3 0/1/2/3/4/5 (SATA 6Gb/s Connectors)

The SATA connectors conform to SATA 6Gb/s standard and are compatible with SATA 3Gb/s and SATA 1.5Gb/s standard. Each SATA connector supports a single SATA device. The Intel® Chipset supports RAID 0, RAID 1, RAID 5, and RAID 10. Refer to Chapter 3, "Configuring SATA Hard Drive(s)," for instructions on configuring a RAID array.

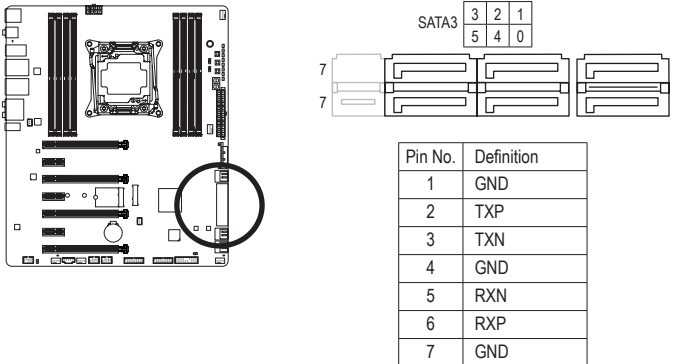

To enable hot-plugging for the SATA ports, refer to Chapter 2, "BIOS Setup," "Chipset/PCH SATA Configuration," for more information.

## 11) sSATA3 0/1/2/3 (SATA 6Gb/s Connectors)

The SATA connectors conform to SATA 6Gb/s standard and are compatible with SATA 3Gb/s and SATA 1.5Gb/s standards. Only AHCI and IDE modes are supported. Each SATA connector supports a single SATA device.

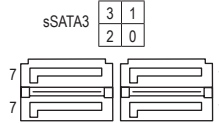
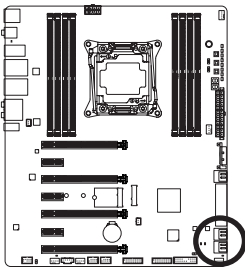

Pin No.	Definition
1	GND
2	TXP
3	TXN
4	GND
5	RXN
6	RXP
7	GND



To enable hot-plugging for the SATA ports, refer to Chapter 2, "BIOS Setup," "Chipset\PCH sSATA Configuration," for more information.

## 12) CLR\_CMOS (Clear CMOS Jumper)

Use this jumper to clear the BIOS configuration and reset the CMOS values to factory defaults. To clear the CMOS values, use a metal object like a screwdriver to touch the two pins for a few seconds.

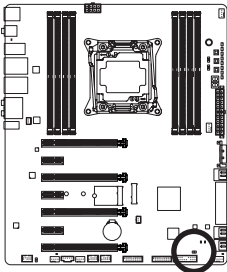

Open: Normal



Short: Clear CMOS Values



- Always turn off your computer and unplug the power cord from the power outlet before clearing the CMOS values.
- After system restart, go to BIOS Setup to load factory defaults (select Load Optimized Defaults) or manually configure the BIOS settings (refer to Chapter 2, "BIOS Setup," for BIOS configurations).

### 13) M2\_10G (M.2 Socket 3 Connector)

You can insert an M.2 SSD into this connector.

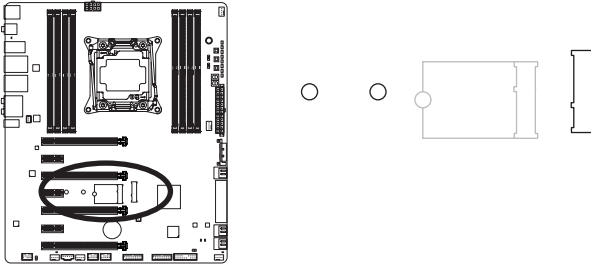

Follow the steps below to correctly install an M.2 SSD in the M.2 connector.

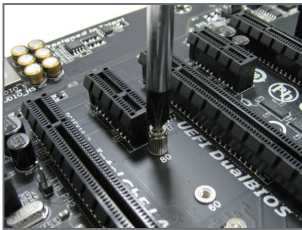

**Step 1:**  
Use a screw driver to unfasten the screw and nut from the motherboard. Locate the proper mounting hole for the M.2 SSD to be installed and then screw the nut first.

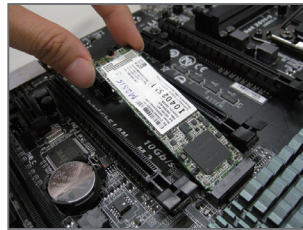

**Step 2:**  
Slide the M.2 SSD into the connector at an oblique angle.

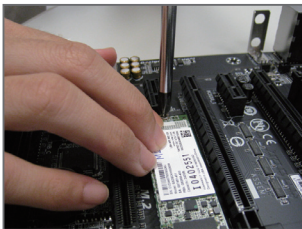

**Step 3:**  
Press the M.2 SSD down and then secure it with the screw.

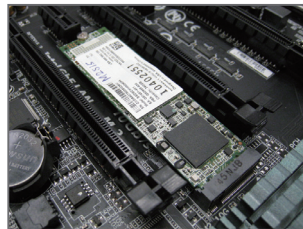

**Step 4:**  
The installation is completed, as shown in the picture above.



- On the motherboard there are two length adjustment holes for the M.2 SSD. Select the proper hole for the M.2 SSD to be installed and refasten the screw and nut.
- M2\_10G, SATA Express, and SATA3 4/5 connectors can only be used one at a time. The SATA3 4/5 connectors will become unavailable when an M.2 SSD is installed.

## 14) F\_PANEL (Front Panel Header)

Connect the power switch, reset switch, speaker, chassis intrusion switch/sensor and system status indicator on the chassis to this header according to the pin assignments below. Note the positive and negative pins before connecting the cables.

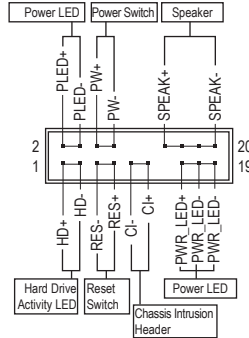
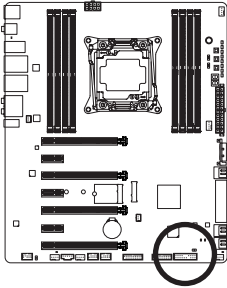

- **PLED/PWR\_LED** (Power LED, Yellow/Purple):

System Status	LED
S0	On
S3/S4/S5	Off

Connects to the power status indicator on the chassis front panel. The LED is on when the system is operating. The LED is off when the system is in S3/S4 sleep state or powered off (S5).

- **PW** (Power Switch, Red):

Connects to the power switch on the chassis front panel. You may configure the way to turn off your system using the power switch (refer to Chapter 2, "BIOS Setup," "Power Management," for more information).

- **SPEAK** (Speaker, Orange):

Connects to the speaker on the chassis front panel. The system reports system startup status by issuing a beep code. One single short beep will be heard if no problem is detected at system startup.

- **HD** (Hard Drive Activity LED, Blue):

Connects to the hard drive activity LED on the chassis front panel. The LED is on when the hard drive is reading or writing data.

- **RES** (Reset Switch, Green):

Connects to the reset switch on the chassis front panel. Press the reset switch to restart the computer if the computer freezes and fails to perform a normal restart.

- **CI** (Chassis Intrusion Header, Gray):

Connects to the chassis intrusion switch/sensor on the chassis that can detect if the chassis cover has been removed. This function requires a chassis with a chassis intrusion switch/sensor.



The front panel design may differ by chassis. A front panel module mainly consists of power switch, reset switch, power LED, hard drive activity LED, speaker and etc. When connecting your chassis front panel module to this header, make sure the wire assignments and the pin assignments are matched correctly.

## 15) F\_AUDIO (Front Panel Audio Header)

The front panel audio header supports Intel High Definition audio (HD) and AC'97 audio. You may connect your chassis front panel audio module to this header. Make sure the wire assignments of the module connector match the pin assignments of the motherboard header. Incorrect connection between the module connector and the motherboard header will make the device unable to work or even damage it.

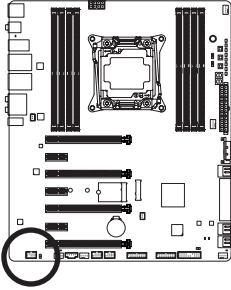

For HD Front Panel Audio:

Pin No.	Definition
1	MIC2_L
2	GND
3	MIC2_R
4	-ACZ_DET
5	LINE2_R
6	GND
7	FAUDIO_JD
8	No Pin
9	LINE2_L
10	GND

For AC'97 Front Panel Audio:

Pin No.	Definition
1	MIC
2	GND
3	MIC Power
4	NC
5	Line Out (R)
6	NC
7	NC
8	No Pin
9	Line Out (L)
10	NC



- The front panel audio header supports HD audio by default. If your chassis provides an AC'97 front panel audio module, refer to the instructions on how to activate AC'97 functionality via the audio software in Chapter 6, "Configuring 2/4/5.1/7.1-Channel Audio."
- Audio signals will be present on both of the front and back panel audio connections simultaneously. If you want to mute the back panel audio (only supported when using an HD front panel audio module), refer to Chapter 6, "Configuring 2/4/5.1/7.1-Channel Audio."
- Some chassis provide a front panel audio module that has separated connectors on each wire instead of a single plug. For information about connecting the front panel audio module that has different wire assignments, please contact the chassis manufacturer.

## 16) SPDIF\_O (S/PDIF Out Header)

This header supports digital S/PDIF Out and connects a S/PDIF digital audio cable (provided by expansion cards) for digital audio output from your motherboard to certain expansion cards like graphics cards and sound cards. For example, some graphics cards may require you to use a S/PDIF digital audio cable for digital audio output from your motherboard to your graphics card if you wish to connect an HDMI display to the graphics card and have digital audio output from the HDMI display at the same time. For information about connecting the S/PDIF digital audio cable, carefully read the manual for your expansion card.

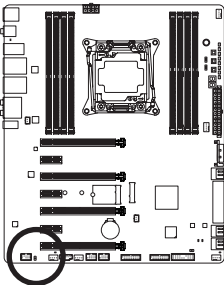

Pin No.	Definition
1	SPDIFO
2	GND



### 17) F\_USB30\_1/F\_USB30\_2 (USB 3.0/2.0 Headers)

The headers conform to USB 3.0/2.0 specification and can provide two USB ports. For purchasing the optional 3.5" front panel that provides two USB 3.0/2.0 ports, please contact the local dealer.

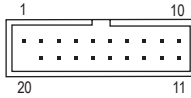
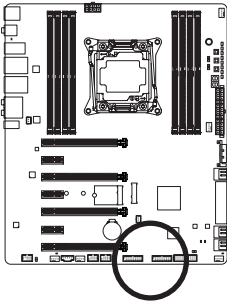

Pin No.	Definition	Pin No.	Definition
1	VBUS	11	D2+
2	SSRX1-	12	D2-
3	SSRX1+	13	GND
4	GND	14	SSTX2+
5	SSTX1-	15	SSTX2-
6	SSTX1+	16	GND
7	GND	17	SSRX2+
8	D1-	18	SSRX2-
9	D1+	19	VBUS
10	NC	20	No Pin



Prior to installing the USB front panel, be sure to turn off your computer and unplug the power cord from the power outlet to prevent damage to the USB front panel.

### 18) F\_USB1/F\_USB2 (USB 2.0/1.1 Headers)

The headers conform to USB 2.0/1.1 specification. Each USB header can provide two USB ports via an optional USB bracket. For purchasing the optional USB bracket, please contact the local dealer.

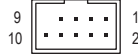
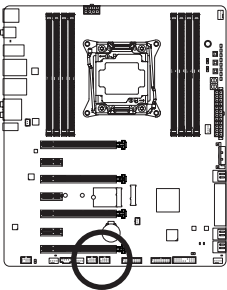

Pin No.	Definition
1	Power (5V)
2	Power (5V)
3	USB DX-
4	USB DY-
5	USB DX+
6	USB DY+
7	GND
8	GND
9	No Pin
10	NC



- Do not plug the IEEE 1394 bracket (2x5-pin) cable into the USB 2.0/1.1 header.
- Prior to installing the USB bracket, be sure to turn off your computer and unplug the power cord from the power outlet to prevent damage to the USB bracket.

## 19) THB\_C (Thunderbolt Add-in Card Connector)

This connector is for a GIGABYTE Thunderbolt add-in card.

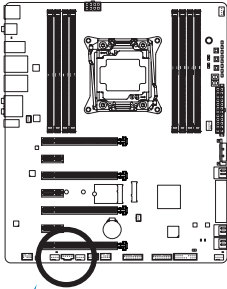

Pin No.	Definition
1	GPIOA
2	GPIOB
3	N_-SLP_S3
4	N_-S4_S5
5	GND



Supports a Thunderbolt™ add-in card.

## 20) BAT (Battery)

The battery provides power to keep the values (such as BIOS configurations, date, and time information) in the CMOS when the computer is turned off. Replace the battery when the battery voltage drops to a low level, or the CMOS values may not be accurate or may be lost.

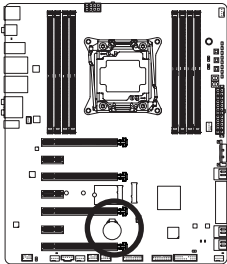

You may clear the CMOS values by removing the battery:

1. Turn off your computer and unplug the power cord.
2. Gently remove the battery from the battery holder and wait for one minute. (Or use a metal object like a screwdriver to touch the positive and negative terminals of the battery holder, making them short for 5 seconds.)
3. Replace the battery.
4. Plug in the power cord and restart your computer.



- Always turn off your computer and unplug the power cord before replacing the battery.
- Replace the battery with an equivalent one. Danger of explosion if the battery is replaced with an incorrect model.
- Contact the place of purchase or local dealer if you are not able to replace the battery by yourself or uncertain about the battery model.
- When installing the battery, note the orientation of the positive side (+) and the negative side (-) of the battery (the positive side should face up).
- Used batteries must be handled in accordance with local environmental regulations.

## Chapter 2 BIOS Setup

BIOS (Basic Input and Output System) records hardware parameters of the system in the CMOS on the motherboard. Its major functions include conducting the Power-On Self-Test (POST) during system startup, saving system parameters and loading operating system, etc. BIOS includes a BIOS Setup program that allows the user to modify basic system configuration settings or to activate certain system features.

When the power is turned off, the battery on the motherboard supplies the necessary power to the CMOS to keep the configuration values in the CMOS.

To access the BIOS Setup program, press the <Delete> key during the POST when the power is turned on.

To upgrade the BIOS, use either the GIGABYTE Q-Flash or @BIOS utility.

- Q-Flash allows the user to quickly and easily upgrade or back up BIOS without entering the operating system.
- @BIOS is a Windows-based utility that searches and downloads the latest version of BIOS from the Internet and updates the BIOS.

For instructions on using the Q-Flash and @BIOS utilities, refer to Chapter 5, "BIOS Update Utilities."



- Because BIOS flashing is potentially risky, if you do not encounter problems using the current version of BIOS, it is recommended that you not flash the BIOS. To flash the BIOS, do it with caution. Inadequate BIOS flashing may result in system malfunction.
- It is recommended that you not alter the default settings (unless you need to) to prevent system instability or other unexpected results. Inadequately altering the settings may result in system's failure to boot. If this occurs, try to clear the CMOS values and reset the board to default values. (Refer to the "Load Optimized Defaults" section in this chapter or introductions of the battery or the clear CMOS jumper/button in Chapter 1 for how to clear the CMOS values.)

## 2-1 Startup Screen

The following startup Logo screen will appear when the computer boots.



### Function Keys:

#### <DEL>: BIOS SETUP/Q-FLASH

Press the <Delete> key to enter BIOS Setup or to access the Q-Flash utility in BIOS Setup.

#### <F9>: SYSTEM INFORMATION

Press the <F9> key to display your system information.

#### <F12>: BOOT MENU

Boot Menu allows you to set the first boot device without entering BIOS Setup. In Boot Menu, use the up arrow key <↑> or the down arrow key <↓> to select the first boot device, then press <Enter> to accept. The system will boot from the device immediately.

Note: The setting in Boot Menu is effective for one time only. After system restart, the device boot order will still be based on BIOS Setup settings.

#### <END>: Q-FLASH

Press the <End> key to access the Q-Flash utility directly without having to enter BIOS Setup first.

## 2-2 The Main Menu

### A. Startup Guide (Default)

The Startup Guide screen simplifies conventional complicated BIOS setup menus and presents only the most frequently used options in the easy-to-use interface. It helps first-time users to perform basic system setups more quickly and easily.



### B. ST Mode (Smart Tweak Mode)

Differing from traditional UEFI interface, the ST Mode provides a fancy and user-friendly BIOS environment where users can easily point and click through various settings and make adjustments for optimum performance. In ST Mode, you can use your mouse to move through the option menus for quick configuration or press <F2> to switch to the traditional BIOS Setup screen.



- When the system is not stable as usual, select the **Load Optimized Defaults** item to set your system to its defaults.
- The BIOS Setup menus described in this chapter are for reference only and may differ by BIOS version.

## C. Classic Setup

Classic Setup is the conventional BIOS Setup interface where you can press the arrow keys on your keyboard to move among the items and press <Enter> to accept or enter a sub-menu. Or you can use your mouse to select the item you want.

(Sample BIOS Version: F1L)

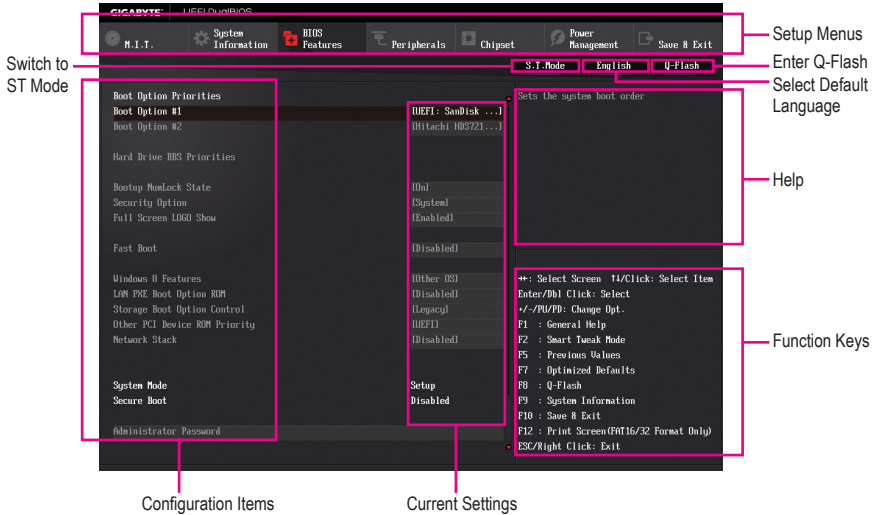

### Classic Setup Function Keys

<←><→>	Move the selection bar to select a setup menu
<↑><↓>	Move the selection bar to select an configuration item on a menu
<Enter>	Execute command or enter a menu
<+></Page Up>	Increase the numeric value or make changes
<-></Page Down>	Decrease the numeric value or make changes
<F1>	Show descriptions of the function keys
<F2>	Switch to ST Mode or Startup Guide screen.
<F5>	Restore the previous BIOS settings for the current submenus
<F7>	Load the Optimized BIOS default settings for the current submenus
<F8>	Access the Q-Flash utility
<F9>	Display system information
<F10>	Save all the changes and exit the BIOS Setup program
<F12>	Capture the current screen as an image and save it to your USB drive
<Esc>	Main Menu: Exit the BIOS Setup program Submenus: Exit current submenu

## **BIOS Setup Menus**

- **M.I.T.**  
Use this menu to configure the clock, frequency, and voltages of your CPU and memory, etc. Or check the system/CPU temperatures, voltages, and fan speeds.
- **System Information**  
Use this menu to configure the default language used by the BIOS and system time and date.
- **BIOS Features**  
Use this menu to configure the device boot order and advanced features available on the CPU.
- **Peripherals**  
Use this menu to configure all peripheral devices, such as USB, display settings, etc.
- **Chipset**  
Use this menu to configure Chipset-related options, such as SATA, onboard LAN, etc.
- **Power Management**  
Use this menu to configure all the power-saving functions.
- **Save & Exit**  
Save all the changes made in the BIOS Setup program to the CMOS and exit BIOS Setup. You can save the current BIOS settings to a profile or load optimized defaults for optimal-performance system operations.

## 2-3 M.I.T.

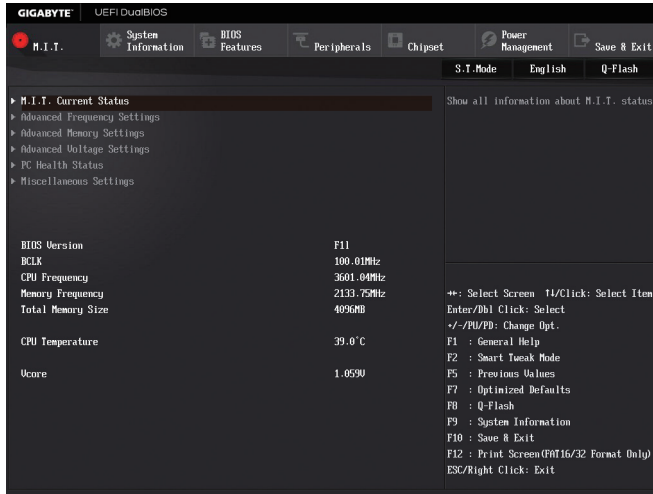

Whether the system will work stably with the overclock/overvoltage settings you made is dependent on your overall system configurations. Incorrectly doing overclock/overvoltage may result in damage to CPU, chipset, or memory and reduce the useful life of these components. This page is for advanced users only and we recommend you not to alter the default settings to prevent system instability or other unexpected results. (Inadequately altering the settings may result in system's failure to boot. If this occurs, clear the CMOS values and reset the board to default values.)

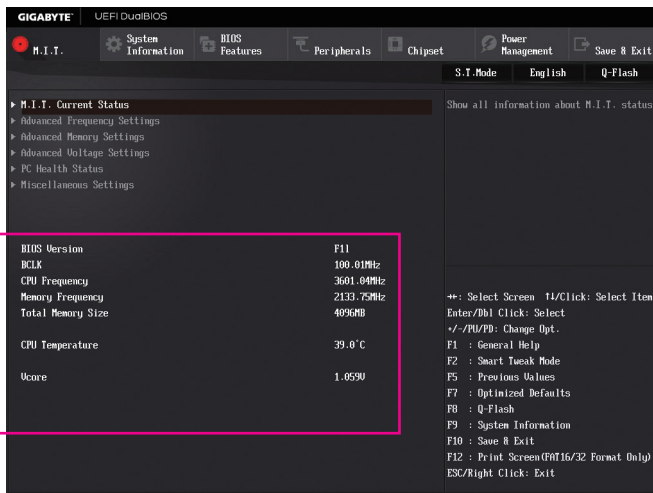

This section provides information on the BIOS version, CPU base clock, CPU frequency, memory frequency, total memory size, CPU temperature and CPU voltage, etc.



## ► M.I.T. Current Status

This screen provides information on CPU/memory frequencies/parameters.

## ► Advanced Frequency Settings

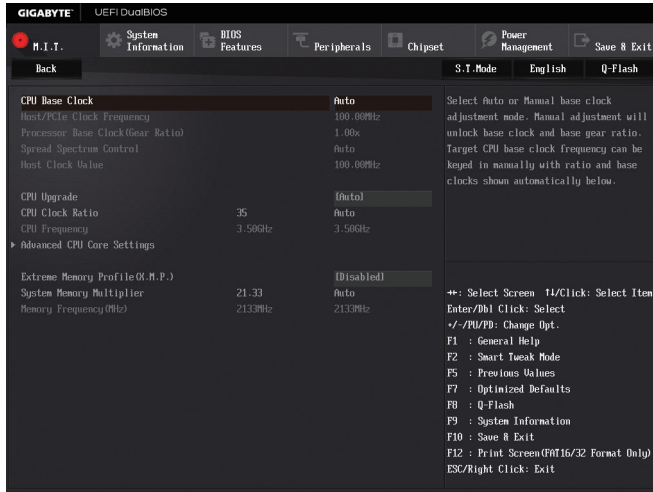

### 🔗 CPU Base Clock

Allows you to manually set the CPU base clock in 0.01 MHz increments. (Default: Auto)

**Important: It is highly recommended that the CPU frequency be set in accordance with the CPU specifications.**

### 🔗 Host/PCIe Clock Frequency <sup>(Note)</sup>

Allows you to manually set the host clock frequency (which controls CPU, PCIe, and memory frequencies) in 0.01 MHz increments.

This item is configurable only when **CPU Base Clock** is set to **Manual**.

### 🔗 Processor Base Clock (Gear Ratio) <sup>(Note)</sup>

Allows you to configure the Processor Base Clock by multiplying the **Host/PCIe Clock Frequency** by several preset host clock multipliers. This item is configurable only when **CPU Base Clock** is set to **Manual**.

### 🔗 Spread Spectrum Control <sup>(Note)</sup>

Enables or disables CPU/PCIe Spread Spectrum. (Default: Auto)

This item is configurable only when **CPU Base Clock** is set to **Manual**.

### 🔗 Host Clock Value

This value is determined by multiplying the **Host/PCIe Clock Frequency** value by the **Processor Base Clock (Gear Ratio)** value.

### 🔗 CPU Upgrade <sup>(Note)</sup>

Allows you to set the CPU frequency. Options may vary depending on the CPU being used. (Default: Auto)

(Note) This item is present only when you install a CPU that supports this feature. For more information about Intel® CPUs' unique features, please visit Intel's website.

### ☞ CPU Clock Ratio

Allows you to alter the clock ratio for the installed CPU. The adjustable range is dependent on the CPU being installed.

### ☞ CPU Frequency

Displays the current operating CPU frequency.

## ▶ Advanced CPU Core Settings

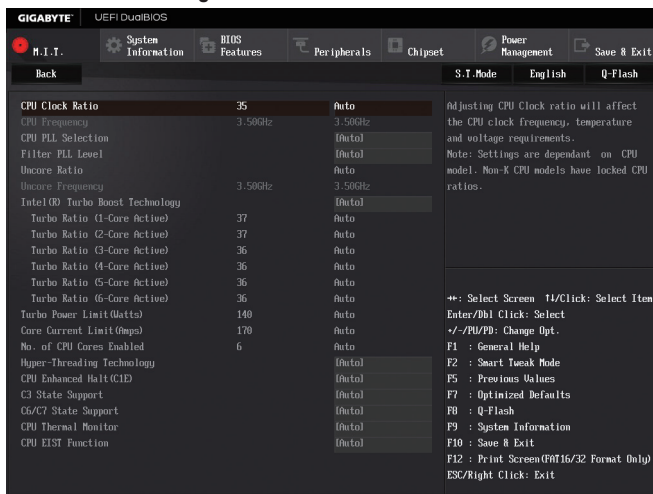

### ☞ CPU Clock Ratio, CPU Frequency

The settings above are synchronous to those under the same items on the **Advanced Frequency Settings** menu.

### ☞ CPU PLL Selection

Allows you to set the CPU PLL. **Auto** lets the BIOS automatically configure this setting. (Default: Auto)

### ☞ Filter PLL Level

Allows you to set the Filter PLL. **Auto** lets the BIOS automatically configure this setting. (Default: Auto)

### ☞ Uncore Ratio

Allows you to set the CPU Uncore ratio. The adjustable range is dependent on the CPU being used.

### ☞ Uncore Frequency

Displays the current CPU Uncore frequency.

### ☞ Intel(R) Turbo Boost Technology <sup>(Note)</sup>

Allows you to determine whether to enable the Intel CPU Turbo Boost technology. **Auto** lets the BIOS automatically configure this setting. (Default: Auto)

### ☞ Turbo Ratio <sup>(Note)</sup>

Allows you to set the CPU Turbo ratios for different number of active cores. **Auto** sets the CPU Turbo ratios according to the CPU specifications. (Default: Auto)

(Note) This item is present only when you install a CPU that supports this feature. For more information about Intel® CPUs' unique features, please visit Intel's website.

- ☞ **Turbo Power Limit (Watts)**

Allows you to set a power limit for CPU Turbo mode. When the CPU power consumption exceeds the specified power limit, the CPU will automatically reduce the core frequency in order to reduce the power. **Auto** sets the power limit according to the CPU specifications. (Default: Auto)
- ☞ **Core Current Limit (Amps)**

Allows you to set a current limit for CPU Turbo mode. When the CPU current exceeds the specified current limit, the CPU will automatically reduce the core frequency in order to reduce the current. **Auto** sets the power limit according to the CPU specifications. (Default: Auto)
- ☞ **No. of CPU Cores Enabled** (Note)

Allows you to select the number of CPU cores to enable in an Intel® multi-core CPU (the number of CPU cores may vary by CPU). **Auto** lets the BIOS automatically configure this setting. (Default: Auto)
- ☞ **Hyper-Threading Technology** (Note)

Allows you to determine whether to enable multi-threading technology when using an Intel® CPU that supports this function. This feature only works for operating systems that support multi-processor mode. **Auto** lets the BIOS automatically configure this setting. (Default: Auto)
- ☞ **CPU Enhanced Halt (C1E)** (Note)

Enables or disables Intel® CPU Enhanced Halt (C1E) function, a CPU power-saving function in system halt state. When enabled, the CPU core frequency and voltage will be reduced during system halt state to decrease power consumption. **Auto** lets the BIOS automatically configure this setting. (Default: Auto)
- ☞ **C3 State Support** (Note)

Allows you to determine whether to let the CPU enter C3 mode in system halt state. When enabled, the CPU core frequency and voltage will be reduced during system halt state to decrease power consumption. The C3 state is a more enhanced power-saving state than C1. **Auto** lets the BIOS automatically configure this setting. (Default: Auto)
- ☞ **C6/C7 State Support** (Note)

Allows you to determine whether to let the CPU enter C6/C7 mode in system halt state. When enabled, the CPU core frequency and voltage will be reduced during system halt state to decrease power consumption. The C6/C7 state is a more enhanced power-saving state than C3. **Auto** lets the BIOS automatically configure this setting. (Default: Auto)
- ☞ **CPU Thermal Monitor** (Note)

Enables or disables Intel® Thermal Monitor function, a CPU overheating protection function. When enabled, the CPU core frequency and voltage will be reduced when the CPU is overheated. **Auto** lets the BIOS automatically configure this setting. (Default: Auto)
- ☞ **CPU EIST Function** (Note)

Enables or disables Enhanced Intel® Speed Step Technology (EIST). Depending on CPU loading, Intel EIST technology can dynamically and effectively lower the CPU voltage and core frequency to decrease average power consumption and heat production. **Auto** lets the BIOS automatically configure this setting. (Default: Auto)

(Note) This item is present only when you install a CPU that supports this feature. For more information about Intel® CPUs' unique features, please visit Intel's website.

### Extreme Memory Profile (X.M.P.) <sup>(Note)</sup>

Allows the BIOS to read the SPD data on XMP memory module(s) to enhance memory performance when enabled.

- ▶ Disabled Disables this function. (Default)
- ▶ Profile1 Uses Profile 1 settings.
- ▶ Profile2 <sup>(Note)</sup> Uses Profile 2 settings.

### System Memory Multiplier

Allows you to set the system memory multiplier. **Auto** sets memory multiplier according to memory SPD data. (Default: Auto)

### Memory Frequency (MHz)

The first memory frequency value is the normal operating frequency of the memory being used; the second is the memory frequency that is automatically adjusted according to the **System Memory Multiplier** settings.

## Advanced Memory Settings

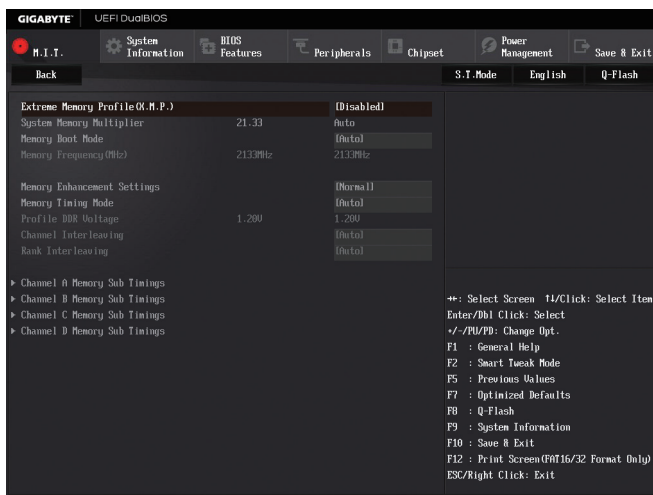

### Extreme Memory Profile (X.M.P.) <sup>(Note)</sup>, System Memory Multiplier, Memory Frequency(MHz)

The settings above are synchronous to those under the same items on the **Advanced Frequency Settings** menu.

### Memory Boot Mode

Provides memory detection and training methods.

- ▶ Auto Lets the BIOS automatically configure this setting. (Default)
- ▶ Enable Fast Boot Skip memory detection and training in some specific criteria for faster memory boot.
- ▶ Disable Fast Boot Detect and train memory at every single boot.

### Memory Enhancement Settings

Provides three different memory performance enhancement settings: Normal (basic performance), Enhanced Stability, and Enhanced Performance. (Default: Normal)

(Note) This item is present only when you install a CPU and a memory module that support this feature.

## Memory Timing Mode

**Manual** and **Advanced Manual** allows the **Channel Interleaving**, **Rank Interleaving**, and memory timing settings below to be configurable. Options are: Auto (default), Manual, Advanced Manual.

## Profile DDR Voltage

When using a non-XMP memory module or **Extreme Memory Profile (X.M.P.)** is set to **Disabled**, the value is displayed according to your memory specification. When Extreme Memory Profile (X.M.P.) is set to **Profile1** or **Profile2**, the value is displayed according to the SPD data on the XMP memory.

## Channel Interleaving

Enables or disables memory channel interleaving. **Enabled** allows the system to simultaneously access different channels of the memory to increase memory performance and stability. **Auto** lets the BIOS automatically configure this setting. (Default: Auto)

## Rank Interleaving

Enables or disables memory rank interleaving. **Enabled** allows the system to simultaneously access different ranks of the memory to increase memory performance and stability. **Auto** lets the BIOS automatically configure this setting. (Default: Auto)

## Channel A/B/C/D Memory Sub Timings

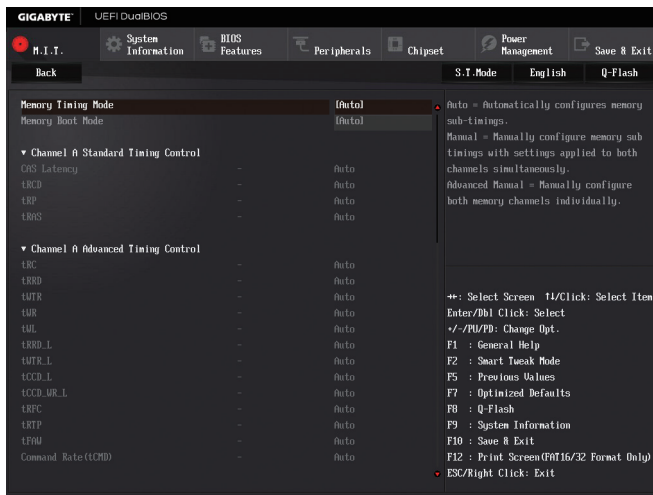

This sub-menu provides memory timing settings for each channel of memory. The respective timing setting screens are configurable only when **Memory Timing Mode** is set to **Manual** or **Advanced Manual**. Note: Your system may become unstable or fail to boot after you make changes on the memory timings. If this occurs, please reset the board to default values by loading optimized defaults or clearing the CMOS values.

## ▶ Advanced Voltage Settings

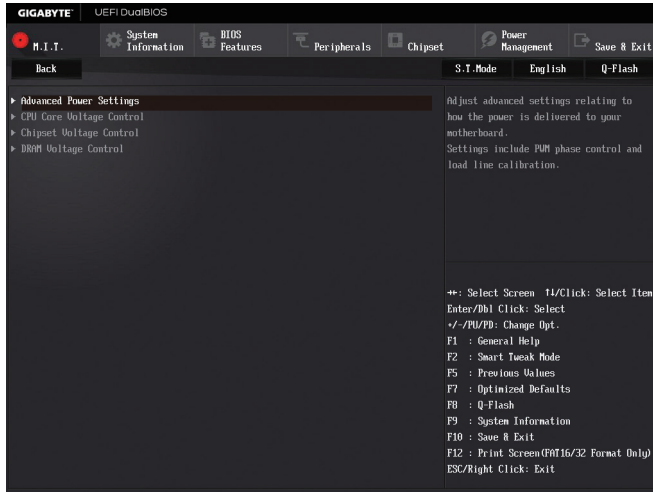

## ▶ Advanced Power Settings

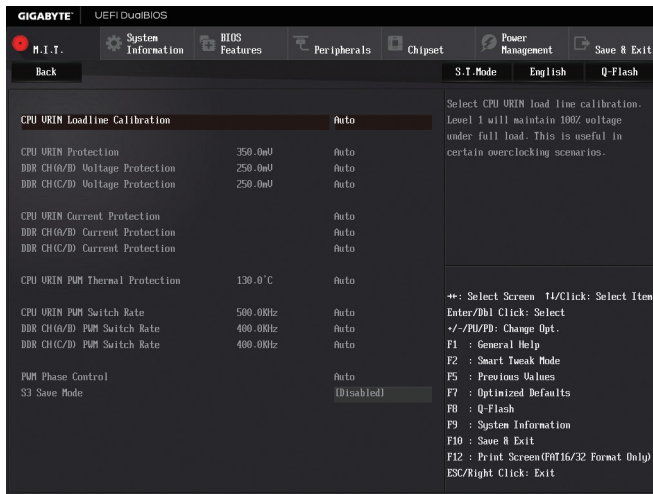

### ☞ CPU VRIN Loadline Calibration

Allows you to set the Load-Line Calibration level for the CPU VRIN. The levels are (from highest to lowest): Extreme, Turbo, High, Medium, Low, and Standard. Selecting a higher level keeps the CPU VRIN voltage more consistent with what is set in BIOS under heavy load. **Auto** lets the BIOS automatically configure this setting and sets the voltage following Intel's specifications. (Default: Auto)

### ☞ CPU VRIN Protection

Allows you to set the over-current protection level for the CPU VRIN voltage. The adjustable range is from 150.0mV to 400.0mV. **Auto** lets the BIOS automatically configure this setting. (Default: Auto)

- ☞ **DDR CH(A/B) Voltage Protection**  
 Allows you to set the voltage limit on Channel A and Channel B memory voltage for over-voltage protection. The adjustable range is from 150.0mV to 325.0mV. **Auto** lets the BIOS automatically configure this setting. (Default: Auto)
- ☞ **DDR CH(C/D) Voltage Protection**  
 Allows you to set the voltage limit on Channel C and Channel D memory voltage for over-voltage protection. The adjustable range is from 150.0mV to 325.0mV. **Auto** lets the BIOS automatically configure this setting. (Default: Auto)
- ☞ **CPU VRIN Current Protection**  
 Allows you to set the over-current protection level for the CPU VRIN voltage.

  - ▶▶ Auto Lets the BIOS automatically configure this setting. (Default)
  - ▶▶ Standard~Extreme Selects Standard, Low, Medium, High, Turbo, or Extreme which represents different level of over-current protection for the CPU VRIN voltage.
- ☞ **DDR CH(A/B) Current Protection**  
 Allows you to set the over-current protection level for Channel A and Channel B memory voltage.

  - ▶▶ Auto Lets the BIOS automatically configure this setting. (Default)
  - ▶▶ Standard~Extreme Selects Standard, Low, Medium, High, Turbo, or Extreme which represents different level of over-current protection for the memory voltage.
- ☞ **DDR CH(C/D) Current Protection**  
 Allows you to set the over-current protection level for Channel C and Channel D memory voltage.

  - ▶▶ Auto Lets the BIOS automatically configure this setting. (Default)
  - ▶▶ Standard~Extreme Selects Standard, Low, Medium, High, Turbo, or Extreme which represents different level of over-current protection for the memory voltage.
- ☞ **CPU VRIN PWM Thermal Protection**  
 Allows you to set the PWM thermal protection threshold for the CPU VRIN. The adjustable range is from 120°C~130°C. (Default: Auto)
- ☞ **CPU VRIN PWM Switch Rate**  
 Allows you to set the CPU VRIN PWM frequency. The adjustable range is from 400.0KHz to 600.0KHz. (Default: Auto)
- ☞ **DDR CH(A/B) PWM Switch Rate**  
 Allows you to set the PWM frequency for Channel A and Channel B memory. The adjustable range is from 300.0KHz to 500.0KHz. (Default: Auto)
- ☞ **DDR CH(C/D) PWM Switch Rate**  
 Allows you to set the PWM frequency for Channel C and Channel D memory. The adjustable range is from 300.0KHz to 500.0KHz. (Default: Auto)
- ☞ **PWM Phase Control**  
 Allows you to automatically change the PWM phase according to the CPU load. The power-saving levels are (from lowest to highest): eXm Perf (Extreme Performance ), High Perf (High Performance), Perf (Performance), Balanced, Mid PWR (Mid Power), and Lite PWR (Light Power). **Auto** lets the BIOS automatically configure this setting. (Default: Auto)
- ☞ **S3 Save Mode**  
 Determines whether to allow memory voltage to drop to a power-saving level when the system is in S3 state. (Default: Disabled)

### ▶ CPU Core Voltage Control

This section provides CPU voltage control options.

### ▶ Chipset Voltage Control

This section provides Chipset voltage control options.

### ▶ DRAM Voltage Control

This section provides memory voltage control options.

### ▶ PC Health Status





- ⊟ **Reset Case Open Status**
  - ▶ Disabled Keeps or clears the record of previous chassis intrusion status. (Default)
  - ▶ Enabled Clears the record of previous chassis intrusion status and the **Case Open** field will show "No" at next boot.
- ⊟ **Case Open**

Displays the detection status of the chassis intrusion detection device attached to the motherboard CI header. If the system chassis cover is removed, this field will show "Yes", otherwise it will show "No". To clear the chassis intrusion status record, set **Reset Case Open Status** to **Enabled**, save the settings to the CMOS, and then restart your system.
- ⊟ **CPU Vcore/CPU VRIN/CPU VCCIO/DRAM Channel A/B Voltage/DRAM Channel C/D Voltage/DDRVP Channel A/B Voltage/DDRVP Channel C/D Voltage/+5V/PCH IO/PCH Core/ +12V**

Displays the current system voltages.
- ⊟ **CPU/PCH Temperature**

Displays current CPU/Chipset temperature.
- ⊟ **1st System Temperature/2nd System Temperature**

Displays current system temperatures detected by the system temperature sensors on the motherboard.
- ⊟ **CPU/CPU OPT/System Fan Speed**

Displays current CPU/CPU\_OPT/system fan speeds.
- ⊟ **CPU/System/PCH Temperature Warning**

Sets the warning threshold for CPU/system/Chipset temperature. When temperature exceeds the threshold, BIOS will emit warning sound. Options are: Disabled (default), 60°C/140°F, 70°C/158°F, 80°C/176°F, 90°C/194°F.
- ⊟ **CPU/CPU OPT/System Fan Fail Warning**

Allows the system to emit warning sound if the fan is not connected or fails. Check the fan condition or fan connection when this occurs. (Default: Disabled)
- ⊟ **CPU Fan Speed Control (CPU\_FAN Connector)**

Allows you to determine whether to enable the fan speed control function and adjust the fan speed.

  - ▶ Normal Allows the fan to run at different speeds according to the CPU temperature. You can adjust the fan speed with System Information Viewer based on your system requirements. (Default)
  - ▶ Silent Allows the fan to run at slow speeds.
  - ▶ Manual Allows you to control the fan speed under the **Fan Speed Percentage** item.
  - ▶ Full Speed Allows the fan to run at full speeds.
- ⊟ **Fan Speed Percentage**

Allows you to control the fan speed. This item is configurable only when **CPU Fan Speed Control** is set to **Manual**. Options are: 0.75 PWM value /°C ~ 2.50 PWM value /°C.
- ⊟ **CPU OPT Fan Speed Control (CPU\_OPT Connector)**

Allows you to determine whether to enable the fan speed control function and adjust the fan speed.

  - ▶ Normal Allows the fan to run at different speeds according to the CPU temperature. You can adjust the fan speed with System Information Viewer based on your system requirements. (Default)
  - ▶ Silent Allows the fan to run at slow speeds.
  - ▶ Manual Allows you to control the fan speed under the **Fan Speed Percentage** item.
  - ▶ Full Speed Allows the fan to run at full speeds.

### ☞ **Fan Speed Percentage**

Allows you to control the fan speed. This item is configurable only when **CPU OPT Fan Speed Control** is set to **Manual**. Options are: 0.75 PWM value /°C ~ 2.50 PWM value /°C.

### ☞ **1st System Fan Speed Control (SYS\_FAN1 Connector)**

Allows you to determine whether to enable the fan speed control function and adjust the fan speed.

- ▶▶ Normal      Allows the fan to run at different speeds according to the system temperature. You can adjust the fan speed with System Information Viewer based on your system requirements. (Default)
- ▶▶ Silent        Allows the fan to run at slow speeds.
- ▶▶ Manual        Allows you to control the fan speed under the **Fan Speed Percentage** item.
- ▶▶ Full Speed    Allows the fan to run at full speeds.

### ☞ **Fan Speed Percentage**

Allows you to control the fan speed. This item is configurable only when **1st System Fan Speed Control** is set to **Manual**. Options are: 0.75 PWM value /°C ~ 2.50 PWM value /°C.

### ☞ **2nd System Fan Speed Control (SYS\_FAN2 Connector)**

Allows you to determine whether to enable the fan speed control function and adjust the fan speed.

- ▶▶ Normal      Allows the fan to run at different speeds according to the system temperature. You can adjust the fan speed with System Information Viewer based on your system requirements. (Default)
- ▶▶ Silent        Allows the fan to run at slow speeds.
- ▶▶ Manual        Allows you to control the fan speed under the **Fan Speed Percentage** item.
- ▶▶ Full Speed    Allows the fan to run at full speeds.

### ☞ **Fan Speed Percentage**

Allows you to control the fan speed. This item is configurable only when **2nd System Fan Speed Control** is set to **Manual**. Options are: 0.75 PWM value /°C ~ 2.50 PWM value /°C.

### ☞ **3rd System Fan Speed Control (SYS\_FAN3 Connector)**

Allows you to determine whether to enable the fan speed control function and adjust the fan speed.

- ▶▶ Normal      Allows the fan to run at different speeds according to the system temperature. You can adjust the fan speed with System Information Viewer based on your system requirements. (Default)
- ▶▶ Silent        Allows the fan to run at slow speeds.
- ▶▶ Manual        Allows you to control the fan speed under the **Fan Speed Percentage** item.
- ▶▶ Full Speed    Allows the fan to run at full speeds.

### ☞ **Fan Speed Percentage**

Allows you to control the fan speed. This item is configurable only when **3rd System Fan Speed Control** is set to **Manual**. Options are: 0.75 PWM value /°C ~ 2.50 PWM value /°C.

## ► Miscellaneous Settings

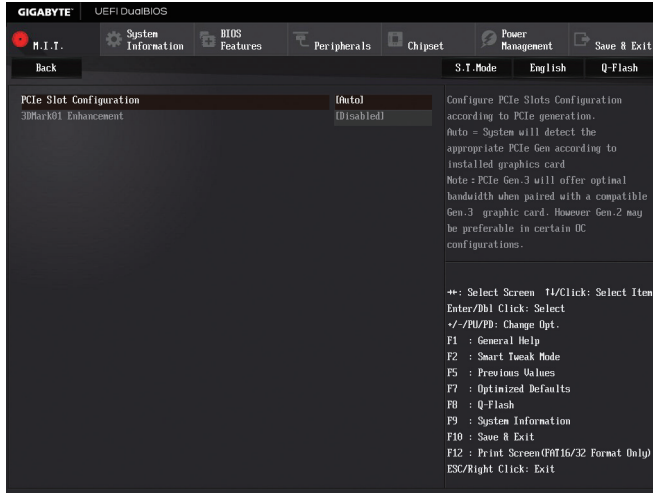

### ☞ PCIe Slot Configuration

Allows you to set the operation mode of the PCI Express slots to Gen 1, Gen 2, or Gen 3. Actual operation mode is subject to the hardware specification of each slot. **Auto** lets the BIOS automatically configure this setting. (Default: Auto)

### ☞ 3DMark01 Enhancement

Allows you to determine whether to enhance some legacy benchmark performance. (Default: Disabled)

## 2-4 System Information

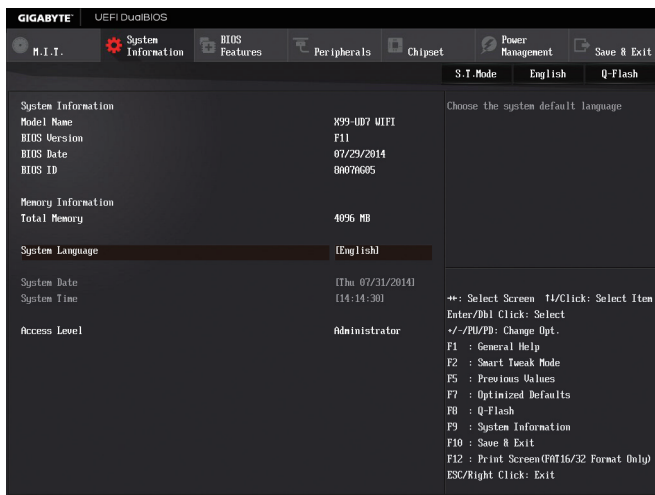

This section provides information on your motherboard model and BIOS version. You can also select the default language used by the BIOS and manually set the system time.

### System Language

Selects the default language used by the BIOS.

### System Date

Sets the system date. The date format is week (read-only), month, date, and year. Use <Enter> to switch between the Month, Date, and Year fields and use the <Page Up> or <Page Down> key to set the desired value.

### Access Level

Displays the current access level depending on the type of password protection used. (If no password is set, the default will display as **Administrator**.) The Administrator level allows you to make changes to all BIOS settings; the User level only allows you to make changes to certain BIOS settings but not all.

## 2-5 BIOS Features



### ☞ Boot Option Priorities

Specifies the overall boot order from the available devices. Removable storage devices that support GPT format will be prefixed with "UEFI:" string on the boot device list. To boot from an operating system that supports GPT partitioning, select the device prefixed with "UEFI:" string.

Or if you want to install an operating system that supports GPT partitioning such as Windows 7 64-bit, select the optical drive that contains the Windows 7 64-bit installation disk and is prefixed with "UEFI:" string.

### ☞ Hard Drive/CD/DVD ROM Drive/Floppy Drive/Network Device BBS Priorities

Specifies the boot order for a specific device type, such as hard drives, optical drives, floppy disk drives, and devices that support Boot from LAN function, etc. Press <Enter> on this item to enter the submenu that presents the devices of the same type that are connected. This item is present only if at least one device for this type is installed.

### ☞ Bootup NumLock State

Enables or disables Numlock feature on the numeric keypad of the keyboard after the POST. (Default: On)

### ☞ Security Option

Specifies whether a password is required every time the system boots, or only when you enter BIOS Setup. After configuring this item, set the password(s) under the **Administrator Password/User Password** item.

- ▶▶ Setup A password is only required for entering the BIOS Setup program.
- ▶▶ System A password is required for booting the system and for entering the BIOS Setup program. (Default)

### ☞ Full Screen LOGO Show

Allows you to determine whether to display the GIGABYTE Logo at system startup. **Disabled** skips the GIGABYTE Logo when the system starts up. (Default: Enabled)

### ☞ Fast Boot

Enables or disables Fast Boot to shorten the OS boot process. **Ultra Fast** provides the fastest bootup speed. (Default: Disabled)

### ☞ **SATA Support**

- ▶▶ All Sata Devices All SATA devices are functional in the operating system and during the POST. (Default)
- ▶▶ Last Boot HDD Only Except for the previous boot drive, all SATA devices are disabled before the OS boot process completes.

This item is configurable only when **Fast Boot** is set to **Enabled** or **Ultra Fast**.

### ☞ **VGA Support**

Allows you to select which type of operating system to boot.

- ▶▶ Auto Enables legacy option ROM only.
- ▶▶ EFI Driver Enables EFI option ROM. (Default)

This item is configurable only when **Fast Boot** is set to **Enabled** or **Ultra Fast**.

### ☞ **USB Support**

- ▶▶ Disabled All USB devices are disabled before the OS boot process completes.
- ▶▶ Full Initial All USB devices are functional in the operating system and during the POST.
- ▶▶ Partial Initial Part of the USB devices are disabled before the OS boot process completes. (Default)

This item is configurable only when **Fast Boot** is set to **Enabled**. This function is disabled when **Fast Boot** is set to **Ultra Fast**.

### ☞ **PS2 Devices Support**

- ▶▶ Disabled All PS/2 devices are disabled before the OS boot process completes.
- ▶▶ Enabled All PS/2 devices are functional in the operating system and during the POST. (Default)

This item is configurable only when **Fast Boot** is set to **Enabled**. This function is disabled when **Fast Boot** is set to **Ultra Fast**.

### ☞ **NetWork Stack Driver Support**

- ▶▶ Disabled Disables booting from the network. (Default)
- ▶▶ Enabled Enables booting from the network.

This item is configurable only when **Fast Boot** is set to **Enabled** or **Ultra Fast**.

### ☞ **Next Boot After AC Power Loss**

- ▶▶ Normal Boot Enables normal bootup upon the return of the AC power. (Default)
- ▶▶ Fast Boot Keeps the Fast Boot settings upon the return of the AC power.

This item is configurable only when **Fast Boot** is set to **Enabled** or **Ultra Fast**.

### ☞ **Windows 8 Features**

Allows you to select the operating system to be installed. (Default: Other OS)

### ☞ **CSM Support**

Enables or disables UEFI CSM (Compatibility Support Module) to support a legacy PC boot process.

- ▶▶ Enabled Enables UEFI CSM. (Default)
- ▶▶ Disabled Disables UEFI CSM and supports UEFI BIOS boot process only.

This item is configurable only when **Windows 8 Features** is set to **Windows 8**.

### ☞ **LAN PXE Boot Option ROM**

Allows you to select whether to enable the legacy option ROM for the LAN controller. (Default: Disabled)

This item is configurable only when **CSM Support** is set to **Enabled**.

### ☞ **Storage Boot Option Control**

Allows you to select whether to enable the UEFI or legacy option ROM for the storage device controller.

- ▶▶ Do not launch Disables option ROM.
- ▶▶ Legacy Enables legacy option ROM only. (Default)

» UEFI Enables UEFI option ROM only.

This item is configurable only when **CSM Support** is set to **Enabled**.

☞ **Other PCI Device ROM Priority**

Allows you to select whether to enable the UEFI or Legacy option ROM for the PCI device controller other than the LAN, storage device, and graphics controllers.

» Legacy Enables legacy option ROM only.

» UEFI Enables UEFI option ROM only. (Default)

This item is configurable only when **CSM Support** is set to **Enabled**.

☞ **Network stack**

Disables or enables booting from the network to install a GPT format OS, such as installing the OS from the Windows Deployment Services server. (Default: Disabled)

☞ **Ipv4 PXE Support**

Enables or disables IPv4 PXE Support. This item is configurable only when **Network stack** is enabled.

☞ **Ipv6 PXE Support**

Enables or disables IPv6 PXE Support. This item is configurable only when **Network stack** is enabled.

☞ **Administrator Password**

Allows you to configure an administrator password. Press <Enter> on this item, type the password, and then press <Enter>. You will be requested to confirm the password. Type the password again and press <Enter>. You must enter the administrator password (or user password) at system startup and when entering BIOS Setup. Differing from the user password, the administrator password allows you to make changes to all BIOS settings.

☞ **User Password**

Allows you to configure a user password. Press <Enter> on this item, type the password, and then press <Enter>. You will be requested to confirm the password. Type the password again and press <Enter>. You must enter the administrator password (or user password) at system startup and when entering BIOS Setup. However, the user password only allows you to make changes to certain BIOS settings but not all.

To cancel the password, press <Enter> on the password item and when requested for the password, enter the correct one first. When prompted for a new password, press <Enter> without entering any password. Press <Enter> again when prompted to confirm.

## 2-6 Peripherals

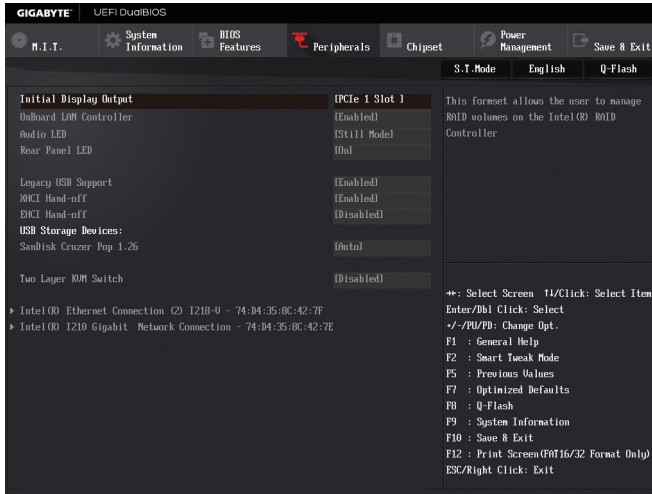

### Initial Display Output

Specifies the first initiation of the monitor display from the PCI Express graphics cards.

- ▶▶ PCIe 1 Slot Sets the graphics card on the PCIE\_1 slot as the first display. (Default)
- ▶▶ PCIe 2 Slot Sets the graphics card on the PCIE\_2 slot as the first display.
- ▶▶ PCIe 3 Slot Sets the graphics card on the PCIE\_3 slot as the first display.
- ▶▶ PCIe 4 Slot Sets the graphics card on the PCIE\_4 slot as the first display.

### OnBoard LAN Controller (LAN1)

Enables or disables the onboard LAN function. (Default: Enabled)

If you wish to install a 3rd party add-in network card instead of using the onboard LAN, set this item to **Disabled**.

### Audio LED

Enables or disables the onboard audio LED function.

- ▶▶ Off Disables this function.
- ▶▶ Still Mode The LED stays constantly on. (Default)
- ▶▶ Beat Mode The brightness of the LED changes according to the music rhythm.
- ▶▶ Pulse Mode The brightness of the LED changes slowly and smoothly like breath.

### Rear Panel LED

Enables or disables the audio LED on the rear panel I/O shield.

- ▶▶ On The LED will light and follow the behavior of the onboard audio LED. (Default)
- ▶▶ Off Disables this function.

### Legacy USB Support

Allows USB keyboard/mouse to be used in MS-DOS. (Default: Enabled)

### XHCI Hand-off

Determines whether to enable XHCI Hand-off feature for an operating system without XHCI Hand-off support. (Default: Enabled)



↳ **EHCI Hand-off**

Determines whether to enable EHCI Hand-off feature for an operating system without EHCI Hand-off support. (Default: Disabled)

↳ **USB Storage Devices**

Displays a list of connected USB mass storage devices. This item appears only when a USB storage device is installed.

↳ **Two Layer KVM Switch**

Set to **Enabled** to ensure proper device functionality when chaining two KVM switches. (Default: Disabled)

▶ **Intel(R) Ethernet Network Connection (LAN2)**

This sub-menu provides information on LAN configuration and related configuration options.

▶ **Intel(R) Ethernet Network Connection (LAN1)**

This sub-menu provides information on LAN configuration and related configuration options.

## 2-7 Chipset

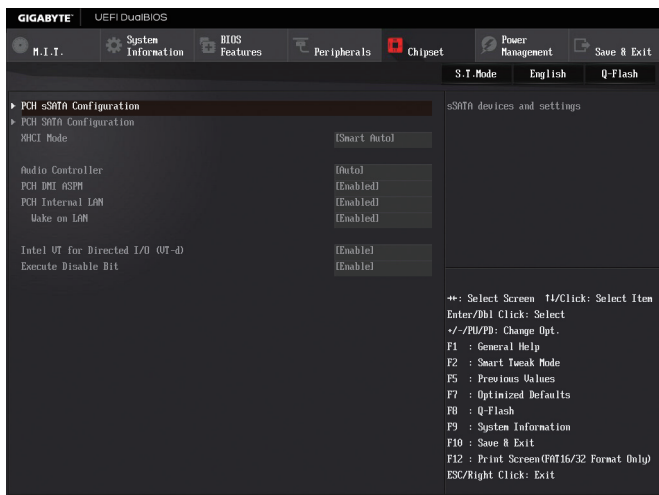

### ▶ PCH sSATA Configuration (sSATA3 0~3 Connectors)

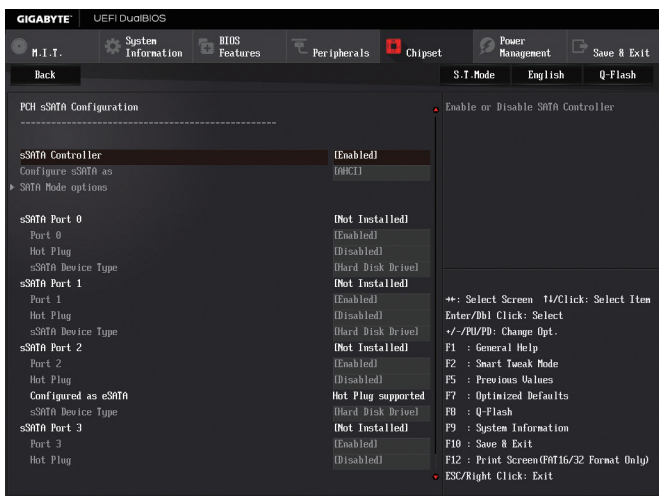

#### ☞ sSATA Controller

Enables or disables the integrated SATA controllers that control the sSATA3 0~3 connectors. (Default: Enabled)

#### ☞ Configure sSATA as

Allows you to decide whether to configure the SATA controllers to AHCI mode.

- ▶▶ IDE      Configures the SATA controllers to IDE mode.
- ▶▶ AHCI     Configures the SATA controllers to AHCI mode. Advanced Host Controller Interface (AHCI) is an interface specification that allows the storage driver to enable advanced Serial ATA features such as Native Command Queuing and hot plug. (Default)

## ▶ SATA Mode options

This sub-menu provides SATA-related configuration options.

### ○ sSATA Port0/1/2/3

Enables or disables each SATA port. (Default: Enabled)

### ○ Hot plug

Enables or disable the hot plug capability for each SATA port. (Default: Disabled)

### ○ sSATA Device Type

Allows you to select the type of the device connected to the SATA port. (Default: Hard Disk Drive)

## ▶ PCH SATA Configuration (SATA3 0~5 Connectors)

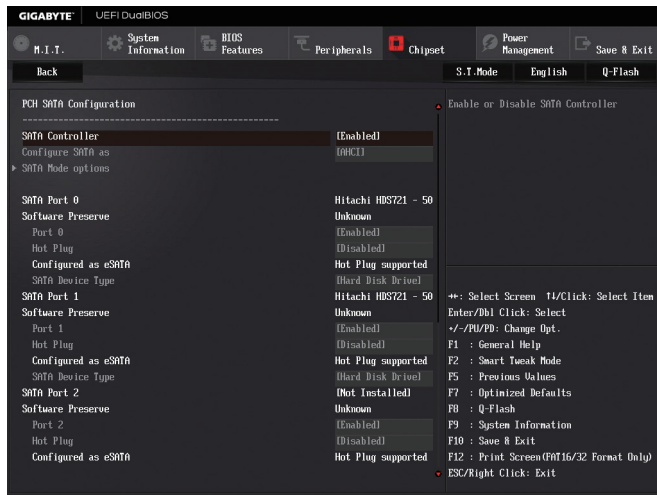

### ○ SATA Controller

Enables or disables the integrated SATA controllers that control the SATA3 0~5 connectors. (Default: Enabled)

### ○ Configure SATA as

Enables or disables RAID for the SATA controllers or configures the SATA controllers to AHCI mode.

▶▶ IDE Configures the SATA controller to IDE mode.

▶▶ RAID Enables RAID for the SATA controller.

▶▶ AHCI Configures the SATA controllers to AHCI mode. Advanced Host Controller Interface (AHCI) is an interface specification that allows the storage driver to enable advanced Serial ATA features such as Native Command Queuing and hot plug. (Default)

## ▶ SATA Mode options

This sub-menu provides SATA-related configuration options.

### ○ SATA Port 0/1/2/3/4/5

Enables or disables each SATA port. (Default: Enabled)

### ○ Hot plug

Enables or disable the hot plug capability for each SATA port. (Default: Disabled)

### ○ SATA Device Type

Allows you to select the type of the device connected to the SATA port. (Default: Hard Disk Drive)

## ☞ **XHCI Mode**

Allows you to determine the operating mode for the xHCI controller in OS.

- ▶▶ **Smart Auto** This mode is available only when the BIOS supports the xHCI controller in the pre-boot environment. This mode is similar to **Auto**, but it adds the capability to route the ports to xHCI or EHCI according to setting used in previous boots (for non-G3 boot) in the pre-boot environment. This allows the use of USB 3.0 devices prior to OS boot. xHCI controller enabling and rerouting should follow the steps in **Auto**, when previous boot routes ports to EHCI. Note: This is the recommended mode when BIOS has xHCI pre-boot support. (Default)
- ▶▶ **Auto** BIOS routes the sharable ports to EHCI controller. Then it uses ACPI protocols to provide an option to enable the xHCI controller and reroute the sharable ports. Note: This is the recommended mode when BIOS does NOT have xHCI pre-boot support.
- ▶▶ **Enabled** All shared ports are eventually routed to the xHCI controller during the BIOS boot process. If BIOS does not have pre-boot support for the xHCI controller, it should initially route the sharable ports to the EHCI controller and then prior to OS boot it should route the ports to xHCI controller. Note: OS has to provide support for the xHCI controller in this mode. If the OS does not provide support, all sharable ports won't work.
- ▶▶ **Disabled** The USB 3.0 ports are routed to the EHCI controller and the xHCI controller is turned off. All USB 3.0 devices function as High Speed devices regardless of xHCI software support/availability.
- ▶▶ **Manual** Allows you to determine whether to route the USB 3.0 ports to the xHCI or EHCI controller before booting to OS, and also provides you with options to manually route each USB 3.0/2.0 port to xHCI or EHCI.

## ☞ **Audio Controller**

Enables or disables the onboard audio function. (Default: Auto)

## ☞ **PCH DMI ASPM**

Allows you to configure the ASPM mode for Chipset DMI link. (Default: Enabled)

## ☞ **PCH Internal LAN (LAN2)**

Enables or disables the onboard LAN function. (Default: Enabled)

If you wish to install a 3rd party add-in network card instead of using the onboard LAN, set this item to **Disabled**.

## ☞ **Wake on LAN**

Enables or disables the wake on LAN function. (Default: Enabled)

## ☞ **Intel VT for Directed I/O (VT-d)<sup>(Note)</sup>**

Enables or disables Intel® Virtualization Technology for Directed I/O. (Default: Enabled)

## ☞ **Execute Disable Bit<sup>(Note)</sup>**

Enables or disables Intel® Execute Disable Bit function. This function may enhance protection for the computer, reducing exposure to viruses and malicious buffer overflow attacks when working with its supporting software and system. (Default: Enabled)

(Note) This item is present only when you install a CPU that supports this feature. For more information about Intel® CPUs' unique features, please visit Intel's website.

## 2-8 Power Management

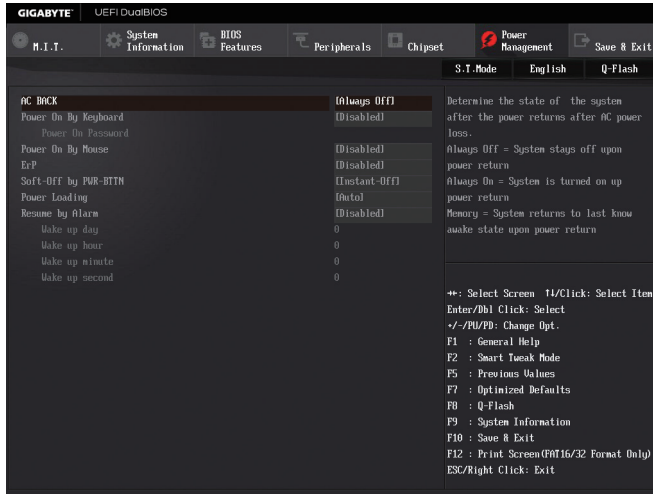

### AC BACK

Determines the state of the system after the return of power from an AC power loss.

- ▶▶ Always Off      The system stays off upon the return of the AC power. (Default)
- ▶▶ Always On        The system is turned on upon the return of the AC power.
- ▶▶ Memory            The system returns to its last known awake state upon the return of the AC power.

### Power On By Keyboard

Allows the system to be turned on by a PS/2 keyboard wake-up event.

Note: To use this function, you need an ATX power supply providing at least 1A on the +5VSB lead.

- ▶▶ Disabled          Disables this function. (Default)
- ▶▶ Any Key            Press any key to turn on the system.
- ▶▶ Keyboard 98        Press POWER button on the Windows 98 keyboard to turn on the system.
- ▶▶ Password          Set a password with 1~5 characters to turn on the system.

### Power On Password

Set the password when **Power On By Keyboard** is set to **Password**.

Press <Enter> on this item and set a password with up to 5 characters and then press <Enter> to accept.

To turn on the system, enter the password and press <Enter>.

Note: To cancel the password, press <Enter> on this item. When prompted for the password, press <Enter> again without entering the password to clear the password settings.

### Power On By Mouse

Allows the system to be turned on by a PS/2 mouse wake-up event.

Note: To use this function, you need an ATX power supply providing at least 1A on the +5VSB lead.

- ▶▶ Disabled          Disables this function. (Default)
- ▶▶ Move                Move the mouse to turn on the system.
- ▶▶ Double Click        Double click on left button on the mouse to turn on the system.

☞ **ErP**

Determines whether to let the system consume least power in S5 (shutdown) state. (Default: Disabled)

Note: When this item is set to **Enabled**, the following functions will become unavailable: Resume by alarm, PME event wake up, power on by mouse, power on by keyboard, and wake on LAN.

☞ **Soft-Off by PWR-BTTN**

Configures the way to turn off the computer in MS-DOS mode using the power button.

- ▶▶ Instant-Off Press the power button and then the system will be turned off instantly. (Default)
- ▶▶ Delay 4 Sec. Press and hold the power button for 4 seconds to turn off the system. If the power button is pressed for less than 4 seconds, the system will enter suspend mode.

☞ **Power Loading**

Enables or disables dummy load. When the power supply is at low load, a self-protection will activate causing it to shutdown or fail. If this occurs, please set to **Enabled**. **Auto** lets the BIOS automatically configure this setting. (Default: Auto)

☞ **Resume by Alarm**

Determines whether to power on the system at a desired time. (Default: Disabled)

If enabled, set the date and time as following:

- ▶▶ Wake up day: Turn on the system at a specific time on each day or on a specific day in a month.
- ▶▶ Wake up hour/minute/second: Set the time at which the system will be powered on automatically.

Note: When using this function, avoid inadequate shutdown from the operating system or removal of the AC power, or the settings may not be effective.

## 2-9 Save & Exit

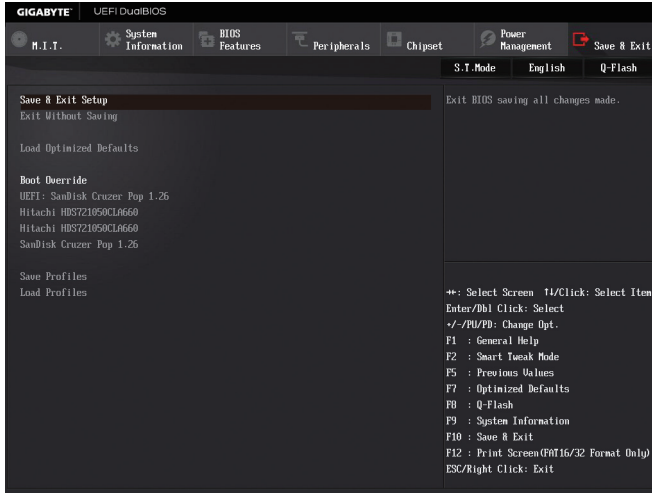

### Save & Exit Setup

Press <Enter> on this item and select **Yes**. This saves the changes to the CMOS and exits the BIOS Setup program. Select **No** or press <Esc> to return to the BIOS Setup Main Menu.

### Exit Without Saving

Press <Enter> on this item and select **Yes**. This exits the BIOS Setup without saving the changes made in BIOS Setup to the CMOS. Select **No** or press <Esc> to return to the BIOS Setup Main Menu.

### Load Optimized Defaults

Press <Enter> on this item and select **Yes** to load the optimal BIOS default settings. The BIOS default settings help the system to operate in optimum state. Always load the Optimized defaults after updating the BIOS or after clearing the CMOS values.

### Boot Override

Allows you to select a device to boot immediately. Press <Enter> on the device you select and select **Yes** to confirm. Your system will restart automatically and boot from that device.

### Save Profiles

This function allows you to save the current BIOS settings to a profile. You can create up to 8 profiles and save as Setup Profile 1~ Setup Profile 8. Or you can select **Select File in HDD/USB/FDD** to save the profile to your storage device.

### Load Profiles

If your system becomes unstable and you have loaded the BIOS default settings, you can use this function to load the BIOS settings from a profile created before, without the hassles of reconfiguring the BIOS settings. First select the profile you wish to load and then press <Enter> to complete. You can select **Select File in HDD/USB/FDD** to input the profile previously created from your storage device or load the profile automatically created by the BIOS, such as reverting the BIOS settings to the last settings that worked properly (last known good record).





## Chapter 3 Configuring SATA Hard Drive(s)

### RAID Levels

	RAID 0	RAID 1	RAID 5	RAID 10
Minimum Number of Hard Drives	≥2	2	≥3	≥4
Array Capacity	Number of hard drives * Size of the smallest drive	Size of the smallest drive	(Number of hard drives - 1) * Size of the smallest drive	(Number of hard drives/2) * Size of the smallest drive
Fault Tolerance	No	Yes	Yes	Yes

### To configure SATA hard drive(s), follow the steps below:

- A. Install SATA hard drive(s) in your computer.
- B. Configure SATA controller mode in BIOS Setup.
- C. Configure a RAID array in RAID BIOS. <sup>(Note 1)</sup>
- D. Install the SATA RAID/AHCI driver and operating system. <sup>(Note 2)</sup>

### Before you begin, please prepare the following items:

- At least two SATA hard drives (to ensure optimal performance, it is recommended that you use two hard drives with identical model and capacity). If you do not want to create RAID, you may prepare only one hard drive.
- A Windows setup disk.
- Motherboard driver disk.
- A USB thumb drive.

## 3-1 Configuring SATA Controllers

### A. Installing SATA hard drive(s) in your computer

Attach one end of the SATA signal cable to the rear of the SATA hard drive and the other end to available SATA port on the motherboard. If you want to configure a RAID set, make sure to connect the hard drives to the SATA 0~5 ports. Then connect the power connector from your power supply to the hard drive.

(Note 1) Skip this step if you do not want to create RAID array on the SATA controller.

(Note 2) Required when the SATA controller is set to AHCI or RAID mode.

## B. Configuring SATA controller mode in BIOS Setup

Make sure to configure the SATA controller mode correctly in system BIOS Setup.

Step 1:

Turn on your computer and press <Delete> to enter BIOS Setup during the POST (Power-On Self-Test). Go to **Chipset/PCB SATA Configuration**, make sure **SATA Controller** is enabled. To create RAID, set **Configure SATA as** to **RAID** (Figure 1). If you do not want to create RAID, set this item to **IDE** or **AHCI**.

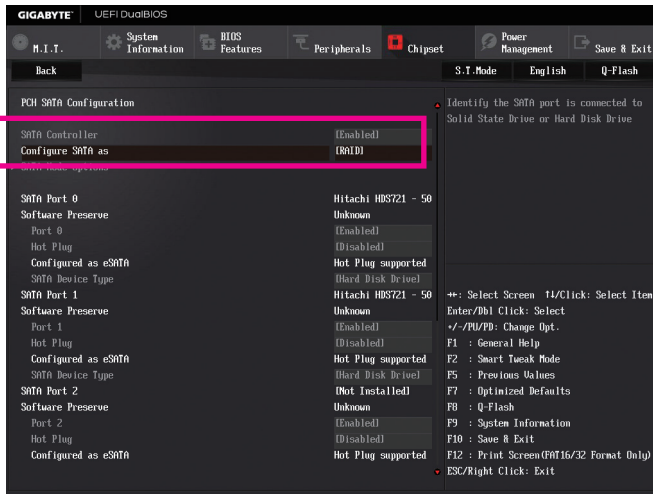

Figure 1

Step 2:

If you want to configure UEFI RAID, follow the steps in "C-1." To enter the legacy RAID ROM, save the settings and exit BIOS Setup. Refer to "C-2" for more information.



The BIOS Setup menus described in this section may differ from the exact settings for your motherboard. The actual BIOS Setup menu options you will see shall depend on the motherboard you have and the BIOS version.

## C-1. UEFI RAID Configuration

Only Windows 8.1/8 64-bit supports UEFI RAID configuration.

Step 1:

In BIOS Setup, go to **BIOS Features** and set **Windows 8 Features** to **Windows 8** and **CSM Support** to **Disabled** (Figure 2). Save the changes and exit BIOS Setup.

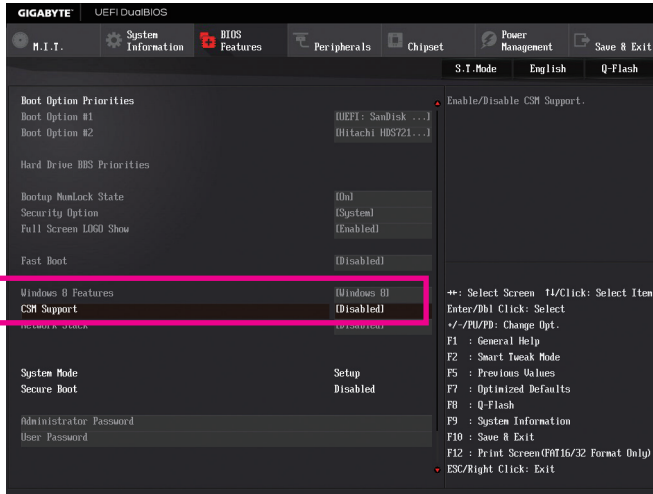

Figure 2

Step 2:

After the system reboot, enter BIOS Setup again. Then enter the **Peripherals/Intel(R) Rapid Storage Technology** sub-menu (Figure 3).

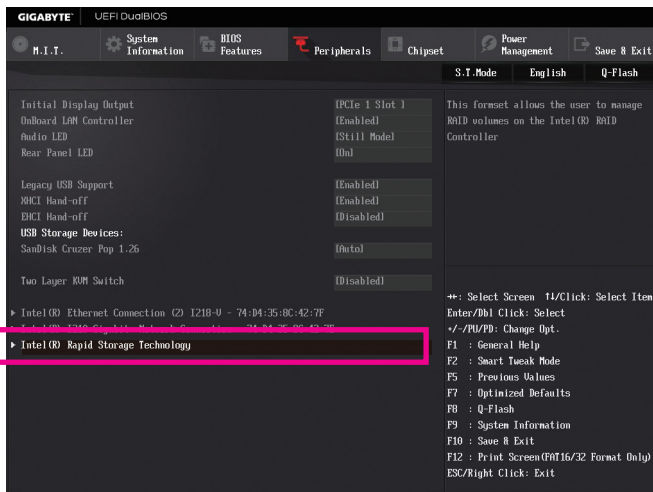

Figure 3

Step 3:

On the **Intel(R) Rapid Storage Technology** menu, press <Enter> on **Create RAID Volume** to enter the **Create RAID Volume** screen. Enter a volume name with 1~16 letters (letters cannot be special characters) under the **Name** item and press <Enter>. Then, select a RAID level (Figure 4). RAID levels supported include RAID 0, RAID 1, RAID 10, and RAID 5 (the selections available depend on the number of the hard drives being installed). Next, use the down arrow key to move to **Select Disks**.

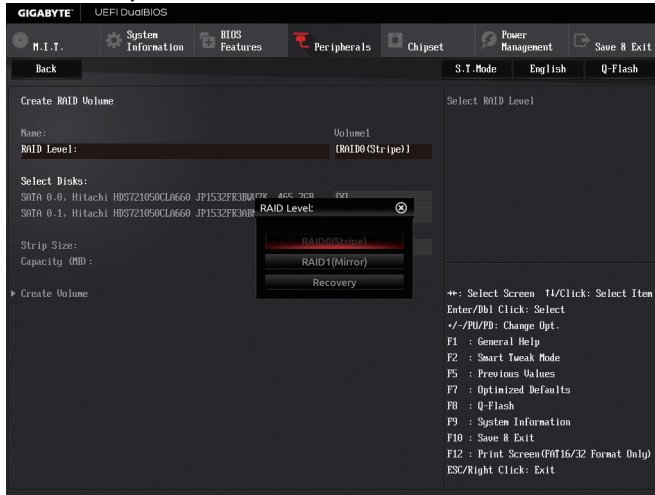

Figure 4

Step 4:

Under **Select Disks** item, select the hard drives to be included in the RAID array. Press the <Space> key on the hard drives to be selected (selected hard drives are marked with "X"). Then set the stripe block size (Figure 5). The stripe block size can be set from 4 KB to 128 KB. Once you have selected the stripe block size, set the volume capacity.

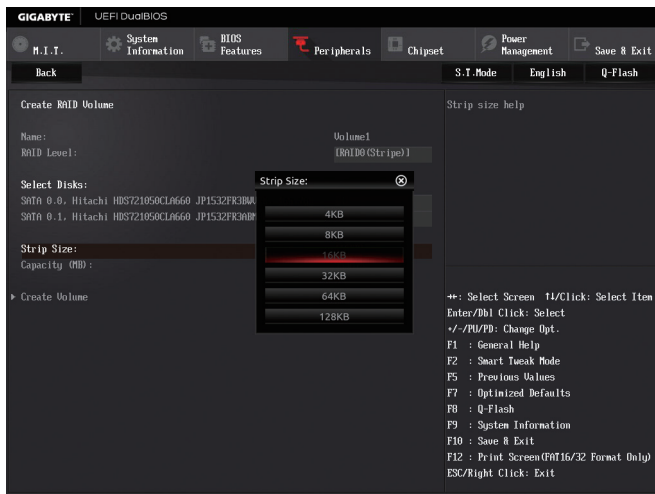

Figure 5

Step 5:

After setting the capacity, move to **Create Volume** and press <Enter> to begin. (Figure 6)

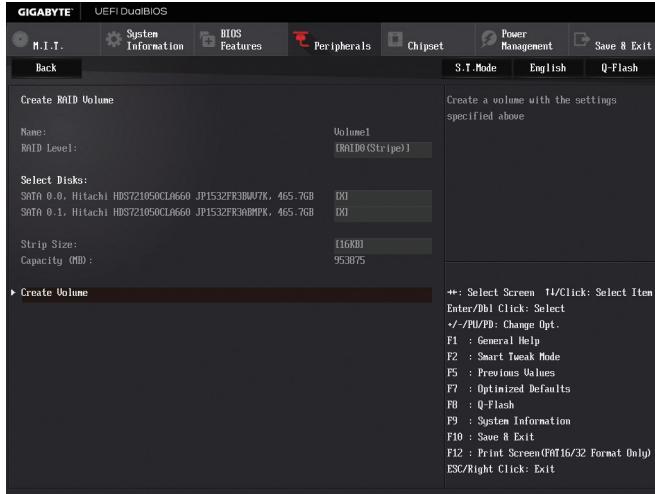

Figure 6

After completing, you'll be brought back to the **Intel(R) Rapid Storage Technology** screen. Under **RAID Volumes** you can see the new RAID volume. To see more detailed information, press <Enter> on the volume to check for information on RAID level, stripe block size, array name, and array capacity, etc. (Figure 7)

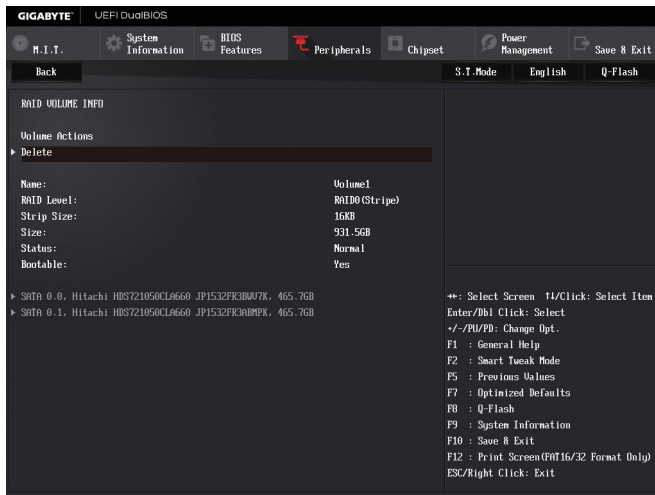

Figure 7

## Delete RAID Volume

To delete a RAID array, press <Enter> on the volume to be deleted on the **Intel(R) Rapid Storage Technology** screen. After entering the **RAID VOLUME INFO** screen, press <Enter> on **Delete** to enter the **Delete** screen. Press <Enter> on **Yes** (Figure 8).

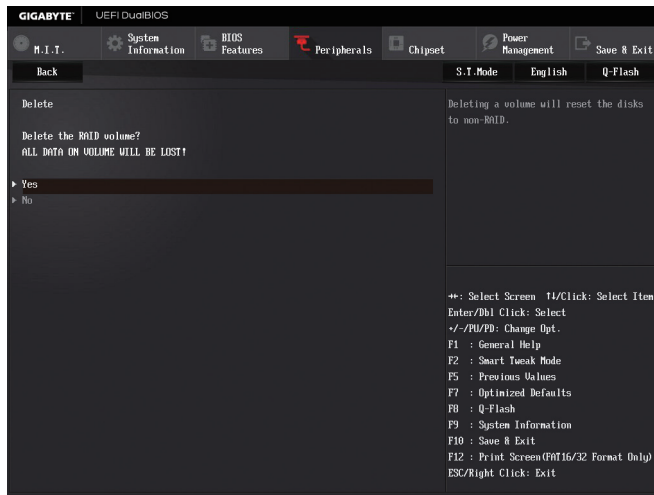

Figure 8

## C-2. Configuring Legacy RAID ROM

Enter the Intel® legacy RAID BIOS setup utility to configure a RAID array. Skip this step and proceed with the installation of Windows operating system for a non-RAID configuration.

### Step 1:

After the POST memory test begins and before the operating system boot begins, look for a message which says "Press <Ctrl-I> to enter Configuration Utility" (Figure 9). Press <Ctrl> + <I> to enter the RAID Configuration Utility.

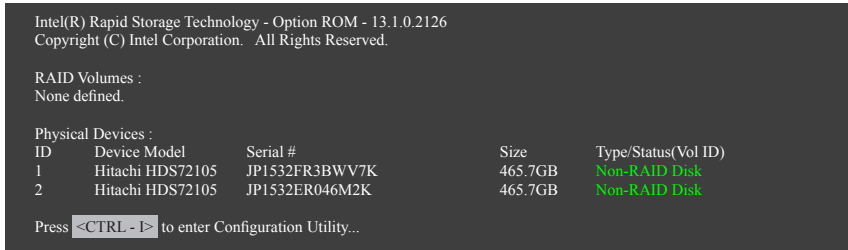

Figure 9

### Step 2:

After you press <Ctrl> + <I>, the **MAIN MENU** screen will appear (Figure 10).

### Create RAID Volume

If you want to create a RAID array, select **Create RAID Volume** in **MAIN MENU** and press <Enter>.

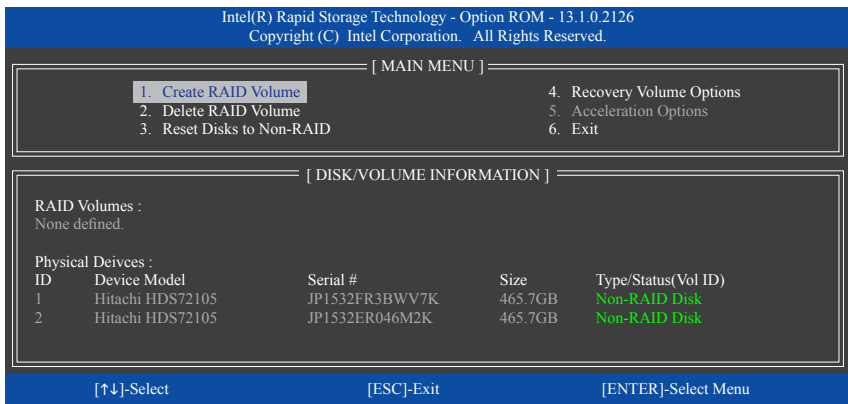

Figure 10

Step 3:

After entering the **CREATE VOLUME MENU** screen, enter a volume name with 1~16 letters (letters cannot be special characters) under the **Name** item and press <Enter>. Then, select a RAID level (Figure 11). RAID levels supported include RAID 0, RAID 1, RAID 10, and RAID 5 (the selections available depend on the number of the hard drives being installed). Press <Enter> to proceed.

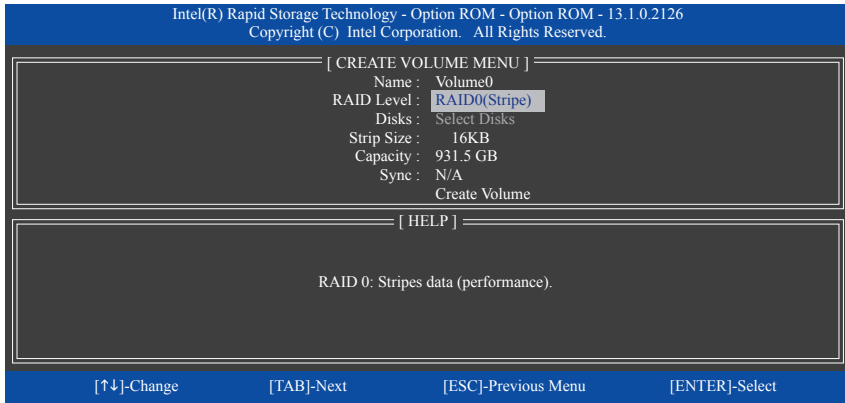

Figure 11

Step 4:

Under **Disks** item, select the hard drives to be included in the RAID array. If only two hard drives are installed, they will be automatically assigned to the array. Set the stripe block size (Figure 12) if necessary. The stripe block size can be set from 4 KB to 128 KB. Once you have selected the stripe block size, press <Enter>.

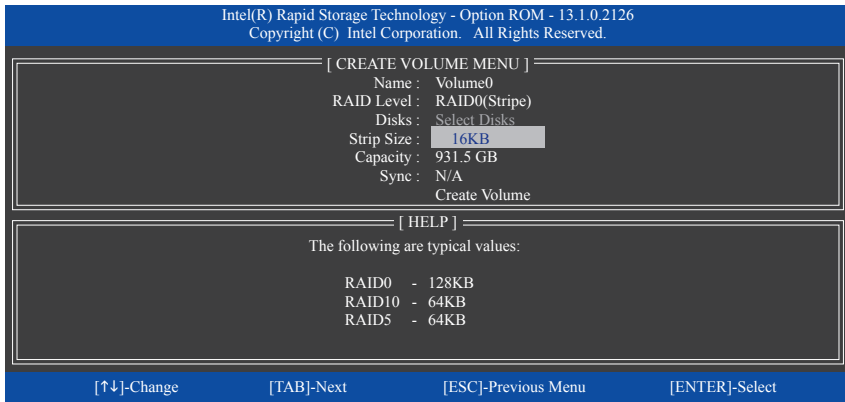

Figure 12



Step 5:

Enter the array capacity and press <Enter>. Finally press <Enter> on the **Create Volume** item to begin creating the RAID array. When prompted to confirm whether to create this volume, press <Y> to confirm or <N> to cancel (Figure 13).

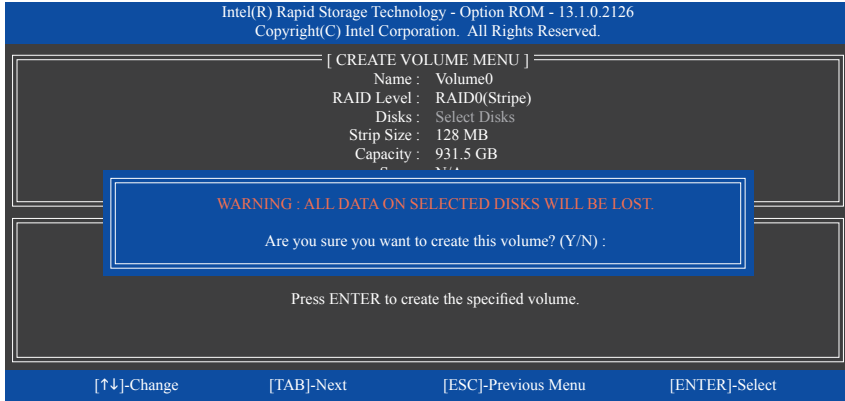

Figure 13

When completed, you can see detailed information about the RAID array in the **DISK/VOLUME INFORMATION** section, including the RAID level, stripe block size, array name, and array capacity, etc. (Figure 14)

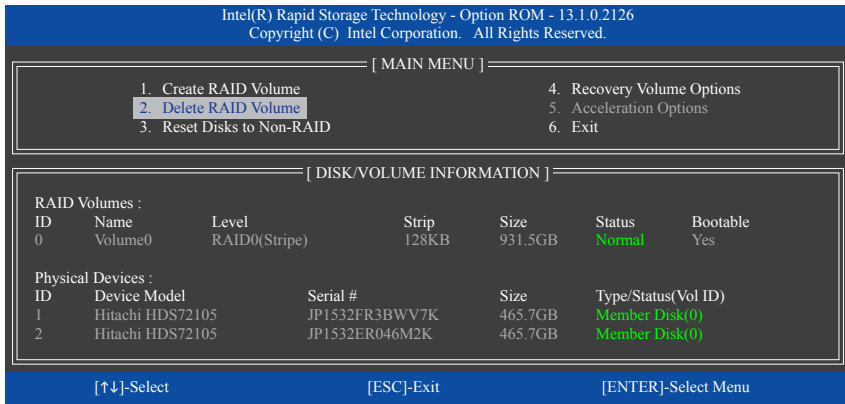

Figure 14

To exit the RAID BIOS utility, press <Esc> or select **6. Exit** in **MAIN MENU**.

Now, you can proceed to install the SATA RAID/AHCI driver and operating system.

## Recovery Volume Options

Intel® Rapid Recover Technology provides data protection by allowing users to easily restore data and system operation using a designated recovery drive. With the Rapid Recovery Technology, which employs RAID 1 functionality, users can copy the data from the master drive to the recovery drive; if needed, the data on the recovery drive can be restored back to the master drive.

Before you begin:

- The recovery drive must have equal or greater capacity than the master drive.
- A recovery volume can be created with two hard drives only. A recovery volume and a RAID array cannot co-exist in the system at the same time, that is, if you have already created a recovery volume, you are unable to create a RAID array.
- By default, only the master drive can be viewed in the operating system; the recovery drive is hidden.

Step 1:

Select **Create RAID Volume** in **MAIN MENU** and press <Enter> (Figure 15).

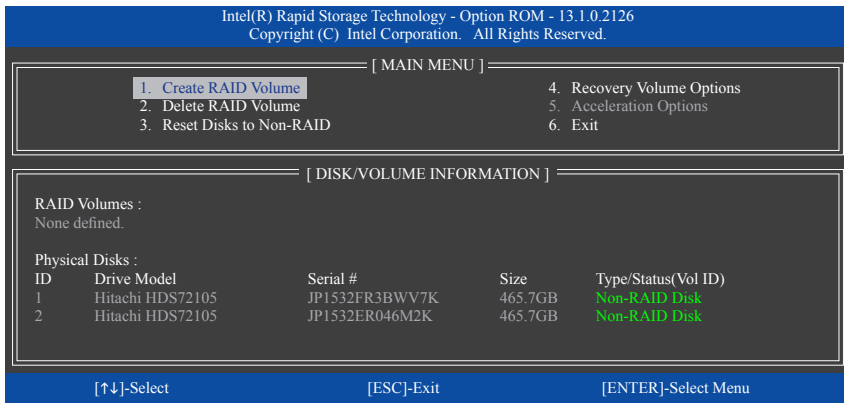

Figure 15

Step 2:

After entering the volume name, select **Recovery** under the **RAID Level** item and press <Enter> (Figure 16).

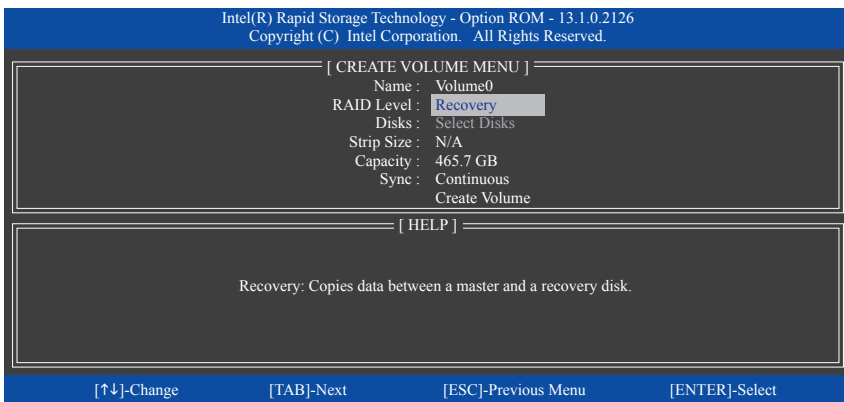

Figure 16

Step 3:

Press <Enter> under the **Select Disks** item. In the **SELECT DISKS** box, press <Tab> on the hard drive you want to use for the master drive and press <Space> on the hard drive you want to use for the recovery drive. (Make sure the recovery drive has equal or larger capacity than the master drive.) Then press <Enter> to confirm (Figure 17).

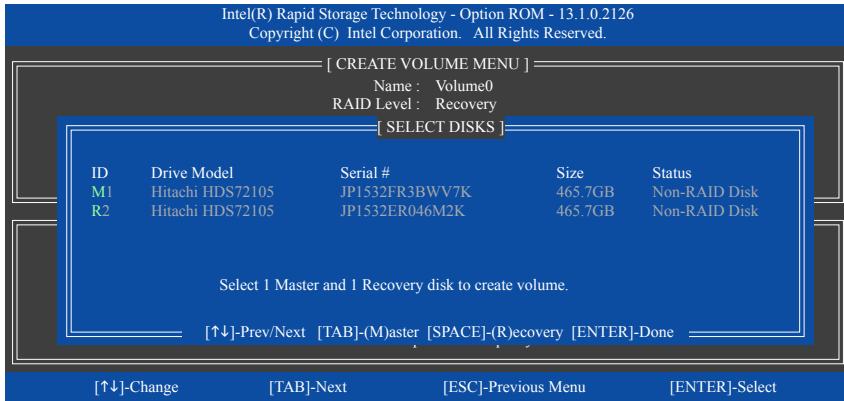

Figure 17

Step 4:

Under **Sync**, select **Continuous** or **On Request** (Figure 18). When set to **Continuous**, changes made to the data on the master drive will be automatically and continuously copied to the recovery drive when both hard drives are installed in the system. **On Request** allows users to update data from the master drive to the recovery drive manually using the Intel® Rapid Storage Technology utility in the operating system. **On Request** also allows users to restore the master drive to a previous state.

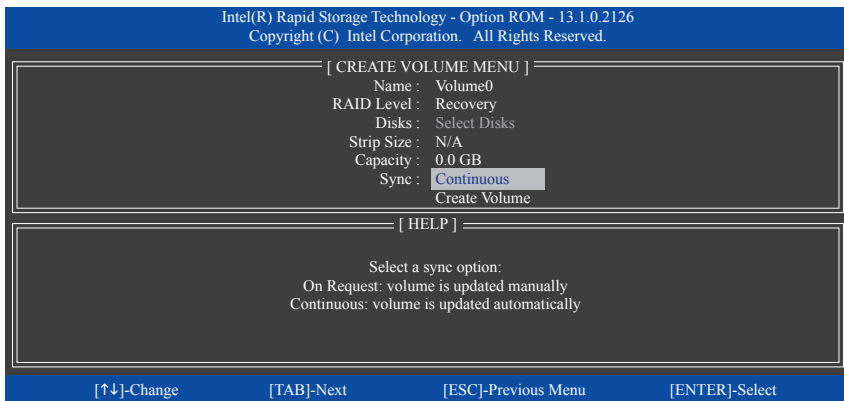

Figure 18

Step 5:

Finally press <Enter> on the **Create Volume** item to begin creating the Recovery Volume and follow the on-screen instructions to complete.

### Delete RAID Volume

To delete a RAID array, select **Delete RAID Volume** in **MAIN MENU** and press <Enter>. In the **DELETE VOLUME MENU** section, use the up or down arrow key to select the array to be deleted and press <Delete>. When prompted to confirm your selection (Figure 19), press <Y> to confirm or <N> to abort.

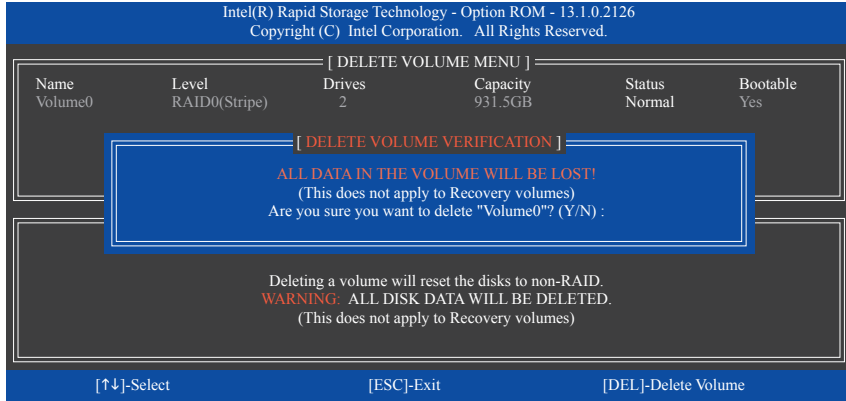

Figure 19

### Acceleration Options

This option allows you to view the status of your accelerated drive/volume (Figure 20) created using the Intel® IRST utility. In case you are unable to run the Intel® IRST utility due to an application error or operating system issue, you will need to remove acceleration or manually enable synchronization (Maximized mode only) using this option in the RAID ROM utility.

Steps:

Select **Acceleration Options** in **MAIN MENU** and press <Enter>.

To remove the acceleration, select the accelerated drive/volume, press <R>, and press <Y> to confirm.

To synchronize data from the cache device to the accelerated drive/volume, press <S> and press <Y> to confirm.

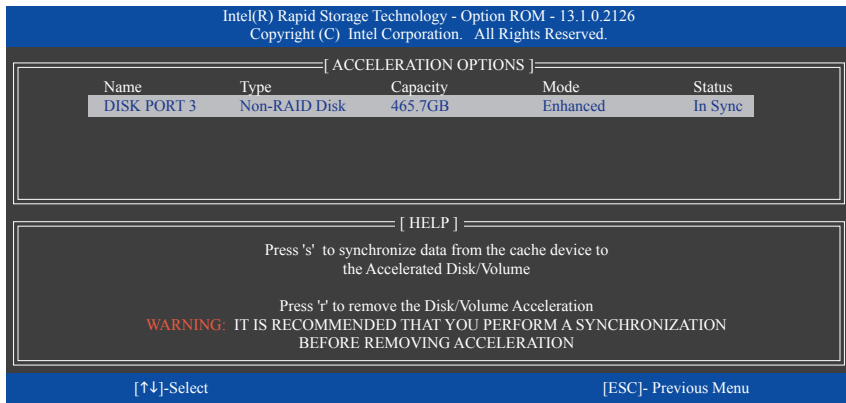

Figure 20

## 3-2 Installing the SATA RAID/AHCI Driver and Operating System

With the correct BIOS settings, you are ready to install Windows 8.1/8/7.

### A. Installing Windows

As some operating systems already include Intel® SATA RAID/AHCI driver, you do not need to install separate RAID/AHCI driver during the Windows installation process. After the operating system is installed, we recommend that you install all required drivers from the motherboard driver disk using "Xpress Install" to ensure system performance and compatibility. If the operating system to be installed requires that you provide additional SATA RAID/AHCI driver during the OS installation process, please refer to the steps below:

Step 1:

Copy the **IRST** folder under **BootDrv** in the driver disk to your USB thumb drive.

Step 2:

Boot from the Windows setup disk and perform standard OS installation steps. When the screen requesting you to load the driver appears, select **Browse**.

Step 3:

Insert the USB thumb drive and then browse to the location of the driver. The locations of the drivers are as follows:

Windows 32-bit: \IRST\32Bit

Windows 64-bit: \IRST\64Bit

Step 4:

When a screen as shown in Figure 1 appears, select **Intel(R) Desktop/Workstation/Server Express Chipset SATA RAID Controller (G:\IRST\32Bit\AStar44.inf)** and click **Next** to load the driver and continue the OS installation.

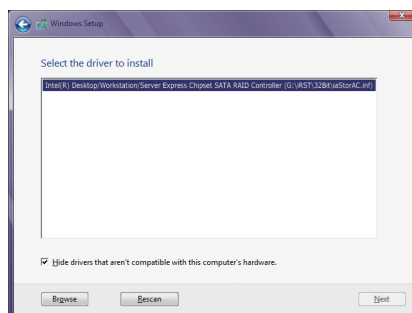

Figure 1

## B. Rebuilding an Array

Rebuilding is the process of restoring data to a hard drive from other drives in the array. Rebuilding applies only to fault-tolerant arrays such as RAID 1, RAID 5 or RAID 10 arrays. The procedures below assume a new drive is added to replace a failed drive to rebuild a RAID 1 array. (Note: The new drive must have equal or greater capacity than the old one.)

Turn off your computer and replace the failed hard drive with a new one. Restart your computer.

- **Enabling Automatic Rebuild**

Step 1:

When the message "Press <Ctrl-> to enter Configuration Utility" appears, press <Ctrl> + <I> to enter the RAID Configuration Utility. The following screen appears after you enter the RAID Configuration Utility.

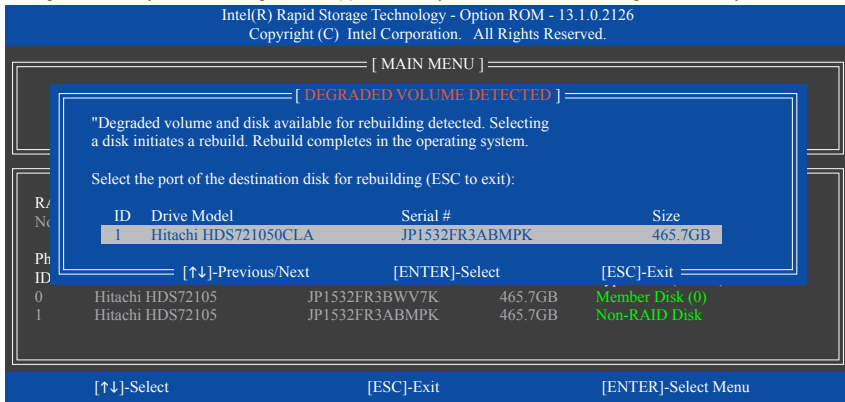

Step 2:

Select the new hard drive to add into the array to be rebuilt and press <Enter>. The following screen appears, indicating that an automatic rebuild will be performed after you enter the operating system. If you do not enable automatic rebuild on this stage, you have to manually rebuild the array in the operating system (see the next page for more details).

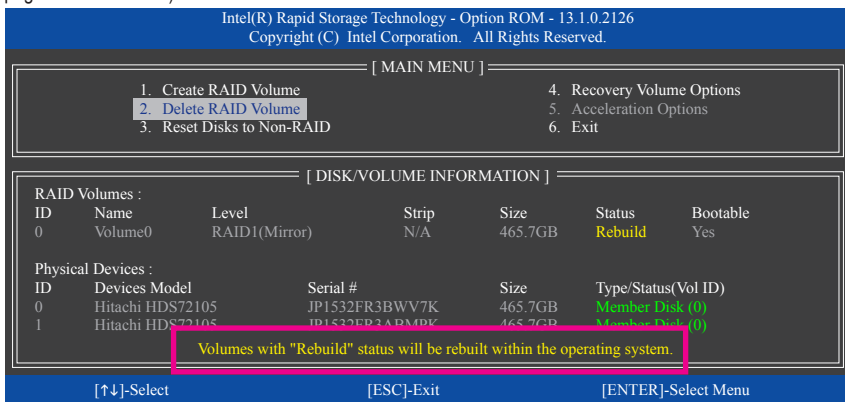

- **Performing the Rebuild in the Operating System**

While in the operating system, make sure the chipset driver has been installed from the motherboard driver disk. Then launch the Intel® Rapid Storage Technology utility from the desktop.

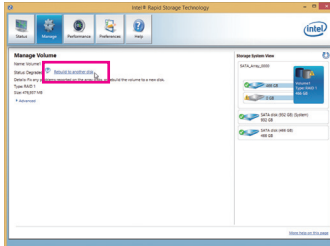

Step 1:

Go to the **Manage** menu and click **Rebuild to another disk in Manage Volume**.

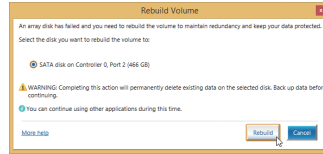

Step 2:

Select a new drive to rebuild the RAID and click **Rebuild**.

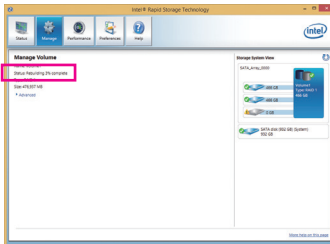

The **Status** item on the left of the screen displays the rebuild progress.

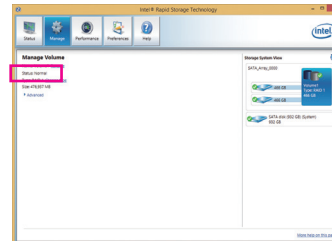

Step 3:

After the RAID 1 volume rebuilding, the **Status** will display as **Normal**.

- **Restoring the Master Drive to a Previous State (for Recovery Volume only)**

When two hard drives are set to Recovery Volume in Update on Request mode, you can restore the master drive data to the last backup state when needed. For example, in case the master drive detects a virus, you can restore the recovery drive data to the master drive.

Step 1:

Select **4. Recovery Volume Options** in the **MAIN MENU** of the Intel® RAID Configuration Utility. On the **RECOVERY VOLUMES OPTIONS** menu, select **Enable Only Recovery Disk** to show the recovery drive in the operating system. Follow the on-screen instructions to complete and exit the RAID Configuration Utility.

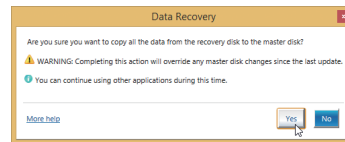
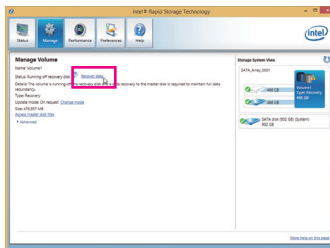
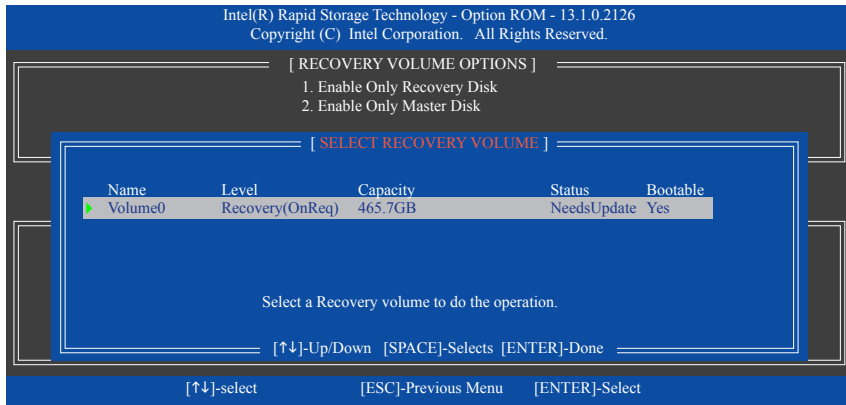

Step 3:  
Click **Yes** to begin the data recovery.

Step 2:

Go to the **Manage** menu of the Intel® Rapid Storage Technology utility and click **Recover data** in **Manage Volume**.

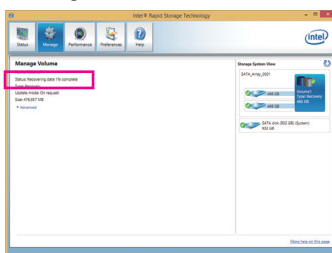

The **Status** item on the left of the screen displays the rebuild progress.

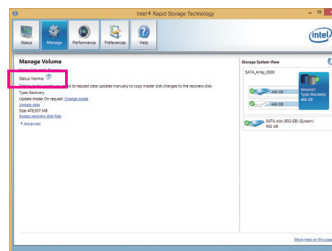

Step 4:  
After the recovery volume is completed, the **Status** will display as **Normal**.



## Chapter 4 Drivers Installation



- Before installing the drivers, first install the operating system. (The following instructions use Windows 8.1 as the example operating system.)
- After installing the operating system, insert the motherboard driver disk into your optical drive. Click on the message "Tap to choose what happens with this disc" on the top-right corner of the screen and select "Run Run.exe." (Or go to My Computer, double-click the optical drive and execute the Run.exe program.)

### 4-1 Chipset Drivers

"Xpress Install" will automatically scan your system and then list all of the drivers that are recommended to install. You can click the **Xpress Install** button and "Xpress Install" will install all of the selected drivers. Or click the  icon to individually install the drivers you need.

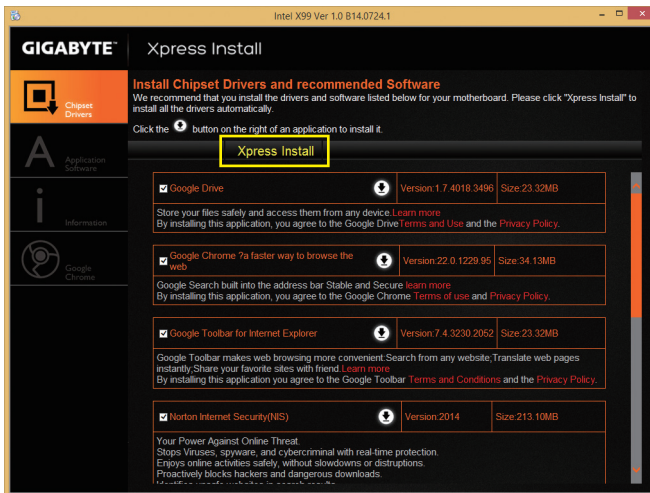

- Please ignore the popup dialog box(es) (e.g. the **Found New Hardware Wizard**) displayed when "Xpress Install" is installing the drivers. Failure to do so may affect the driver installation.
- Some device drivers will restart your system automatically during the driver installation. After the system restart, "Xpress Install" will continue to install other drivers.

## 4-2 Application Software

This page displays the apps that GIGABYTE develops and some free software. You can select the apps you want and click the **Install**  icon to begin the installation.



## 4-3 Information

This page provides detailed information on the drivers on the driver disk. The **Contact** page provides contact information of the GIGABYTE Taiwan headquarter. You can click the URL on this page to link to the GIGABYTE website to check more information on the GIGABYTE headquarter or worldwide branch offices.

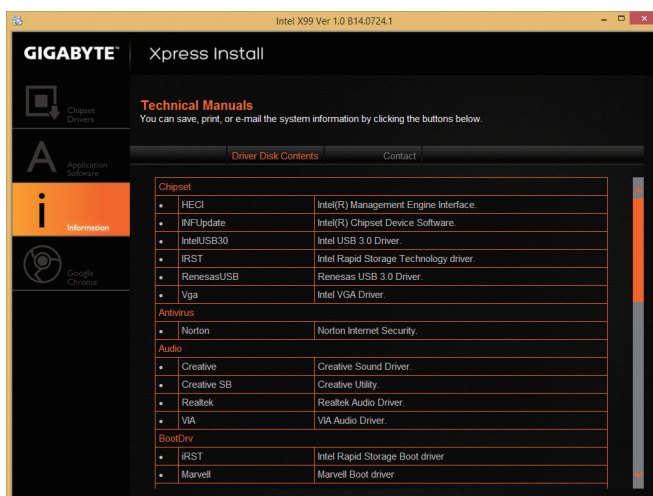

## Chapter 5 Unique Features

### 5-1 BIOS Update Utilities

GIGABYTE motherboards provide two unique BIOS update tools, Q-Flash™ and @BIOS™. GIGABYTE Q-Flash and @BIOS are easy-to-use and allow you to update the BIOS without the need to enter MS-DOS mode. Additionally, this motherboard features the DualBIOS™ design and supports Q-Flash Plus, providing multiple protection for the safety and stability of your computer.

#### What is DualBIOS™?

Motherboards that support DualBIOS have two BIOS onboard, a main BIOS and a backup BIOS. Normally, the system works on the main BIOS. However, if the main BIOS is corrupted or damaged, the backup BIOS will take over on the next system boot and copy the BIOS file to the main BIOS to ensure normal system operation. For the sake of system safety, users cannot update the backup BIOS manually.

#### What is Q-Flash Plus?

Q-Flash Plus is a new solution derived from DualBIOS™. When both the main and backup BIOS fail during system boot, Q-Flash Plus will be automatically launched and then recover BIOS data from the USB flash drive connected to a specific USB port.

#### What is Q-Flash™?

With Q-Flash you can update the system BIOS without having to enter operating systems like MS-DOS or Windows first. Embedded in the BIOS, the Q-Flash tool frees you from the hassles of going through complicated BIOS flashing process.

#### What is @BIOS™?

@BIOS allows you to update the system BIOS while in the Windows environment. @BIOS will download the latest BIOS file from the nearest @BIOS server site and update the BIOS.

### 5-1-1 Updating the BIOS with the Q-Flash Utility

#### A. Before You Begin

1. From GIGABYTE's website, download the latest compressed BIOS update file that matches your motherboard model.
2. Extract the file and save the new BIOS file (e.g. X99UD7WIFI.F1) to your USB flash drive, or hard drive.  
Note: The USB flash drive or hard drive must use FAT32/16/12 file system.
3. Restart the system. During the POST, press the <End> key to enter Q-Flash. Note: You can access Q-Flash by either pressing the <End> key during the POST or pressing the <F8> key in BIOS Setup. However, if the BIOS update file is saved to a hard drive in RAID/AHCI mode or a hard drive attached to an independent SATA controller, use the <End> key during the POST to access Q-Flash.



Because BIOS flashing is potentially risky, please do it with caution. Inadequate BIOS flashing may result in system malfunction.

## B. Updating the BIOS

In the main menu of Q-Flash, use the keyboard or mouse to select an item to execute. When updating the BIOS, choose the location where the BIOS file is saved. The following procedure assumes that you save the BIOS file to a USB flash drive.

Step 1:

1. Insert the USB flash drive containing the BIOS file into the computer. In the main menu of Q-Flash, select **Update BIOS From Drive**.



- The **Save BIOS to Drive** option allows you to save the current BIOS file.
- Q-Flash only supports USB flash drive or hard drives using FAT32/16/12 file system.
- If the BIOS update file is saved to a hard drive in RAID/AHCI mode or a hard drive attached to an independent SATA controller, use the <End> key during the POST to access Q-Flash.

2. Select **USB Flash Drive**.

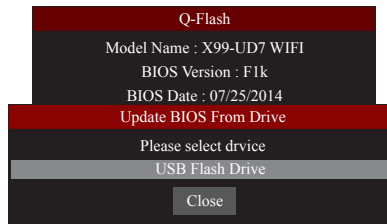

3. Select the BIOS update file.



**Make sure the BIOS update file matches your motherboard model.**

Step 2:

The process of the system reading the BIOS file from the USB flash drive is displayed on the screen. Depending on the BIOS update file, there will be Quick Update and/or Normal Update for you to select. The update will begin after you make the selection. The monitor will display the update process.



- **Do not turn off or restart the system when the system is reading/updating the BIOS.**
- **Do not remove the USB flash drive or hard drive when the system is updating the BIOS.**

Step 3:

The system will restart after the update process is complete.

**Step 4:**

During the POST, press <Delete> to enter BIOS Setup. Select **Load Optimized Defaults** on the **Save & Exit** screen and press <Enter> to load BIOS defaults. System will re-detect all peripheral devices after a BIOS update, so we recommend that you reload BIOS defaults.

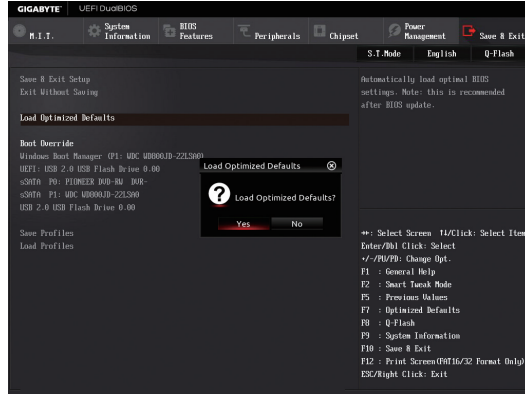

Select **Yes** to load BIOS defaults

**Step 5:**

Select **Save & Exit Setup** and press <Enter>. And then select **Yes** to save settings to CMOS and exit BIOS Setup. The procedure is complete after the system restarts.

## 5-1-2 Updating the BIOS with the @BIOS Utility

### A. Before You Begin

1. In Windows, close all applications and TSR (Terminate and Stay Resident) programs. This helps prevent unexpected failures when performing a BIOS update.
2. If the BIOS is being updated via the Internet, ensure the Internet connection is stable and do NOT interrupt the Internet connection (for example, avoid a power loss or switching off the Internet). Failure to do so may result in a corrupted BIOS or a system that is unable to start.
3. GIGABYTE product warranty does not cover any BIOS damage or system failure resulting from an inadequate BIOS flashing.

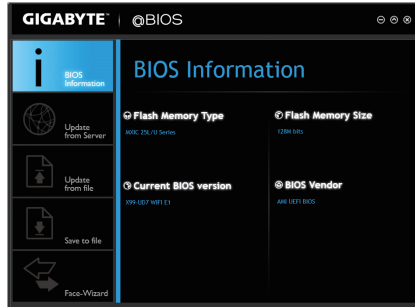

### B. Using @BIOS

#### 1. Update the BIOS Using the Internet Update Function:



Click **Update from Server**, select the @BIOS server site closest to your location and then download the BIOS file that matches your motherboard model. Follow the on-screen instructions to complete.



If the BIOS update file for your motherboard is not present on the @BIOS server site, please manually download the BIOS update file from GIGABYTE's website and follow the instructions in "Update the BIOS without Using the Internet Update Function" below.

#### 2. Update the BIOS without Using the Internet Update Function:



Click **Update from File**, then select the location where you save the BIOS update file obtained from the Internet or through other source. Follow the on-screen instructions to complete.

#### 3. Save the Current BIOS File:



Click **Save to File** to save the current BIOS file.

#### 4. Change the Boot-up Logo:



Click **Upload new image** in Face-Wizard and you will be able to change the boot-up logo with your own picture, creating a personalized boot-up screen. Click **Backup current image** to save the currently used boot-up logo.



Supported image formats include jpg, bmp, and gif.

### C. After Updating the BIOS

Restart your system after updating the BIOS.



- Make sure that the BIOS file to be flashed matches your motherboard model. Updating the BIOS with an incorrect BIOS file could cause your system not to boot.
- Do not turn off the system or remove the power during the BIOS update process, or the BIOS may corrupt and the system may not boot.

### 5-1-3 Using Q-Flash Plus

#### A. Before You Begin

1. From GIGABYTE's website, download the latest compressed BIOS update file that matches your motherboard model.
2. Uncompress the downloaded BIOS file, save it to your USB flash drive, and rename it to **GIGABYTE.bin**.  
Note: The USB flash drive must use FAT32/16/12 file system.
3. Insert the USB flash drive into the white USB port on the back panel.

#### B. Using Q-Flash Plus

If both the main and backup BIOS fail during system boot, wait for 15-20 seconds, the system will automatically search and match the BIOS file in the USB flash drive on the white USB port. The F BIOS\_LED will flash when the BIOS matching and flashing activities start.

Wait for 2-3 minutes and the F BIOS\_LED will stop flashing when the main BIOS flashing is complete.



After the main BIOS is flashed, the system will reboot automatically and then DualBIOS™ will continue to update the backup BIOS. After completion, the system will reboot again and boot from the main BIOS for normal operation.

## 5-2 APP Center

GIGABYTE App Center gives you easy access to a wealth of GIGABYTE apps that help you get the most from your GIGABYTE motherboard (Note). Using a simple, unified user interface, GIGABYTE App Center allows you to easily launch all GIGABYTE apps installed on your system, check related updates online, and download the apps, drivers, and BIOS.

### Running the APP Center

Insert the motherboard driver disk. On the Autorun screen, go to **Application Software** Install GIGABYTE Utilities to install GIGABYTE App Center and the selected apps. Restart your computer after the installation is complete. In Desktop mode, click the App Center icon  in the notification area to launch the App Center utility (Figure 1). On the main menu, you can select an app to run or click **Live Update** to update an app online.

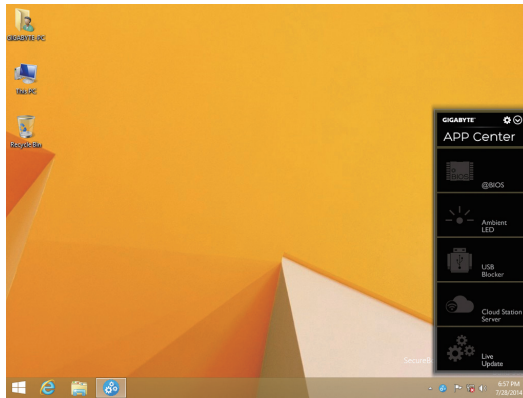

Figure 1

If the App Center is closed, you can restart it by clicking the App Center icon  on the Apps menu (Figure 2).



Figure 2

(Note) Available applications in APP Center may differ by motherboard model. Supported functions of each application may also differ depending on motherboard specifications.







## 5-2-1 EasyTune

GIGABYTE's EasyTune is a simple and easy-to-use interface that allows users to fine-tune their system settings or do overclock/overvoltage in Windows environment.

### The EasyTune Interface



### Tabs Information

Tab	Description
	The <b>Smart Quick Boost</b> tab provides you with different levels of CPU frequency to choose to achieve desired system performance. After making changes, be sure to restart your system for these changes to take effect.
	The <b>Advanced CPU OC</b> tab allows you to set CPU base clock, frequency, and voltages, and integrated graphics frequency. You can save the current settings to a profile. You can create up to 2 profiles.
	The <b>Advanced DDR OC</b> tab allows you to set the memory clock.
	The <b>3D Power</b> tab allows you to change power phase, voltage, and frequency settings.



Available functions in EasyTune may differ by motherboard model. Grayed-out area(s) indicates that the item is not configurable or the function is not supported.



Incorrectly doing overclock/overvoltage may result in damage to the hardware components such as CPU, chipset, and memory and reduce the useful life of these components. Before you do the overclock/overvoltage, make sure that you fully know each function of EasyTune, or system instability or other unexpected results may occur.



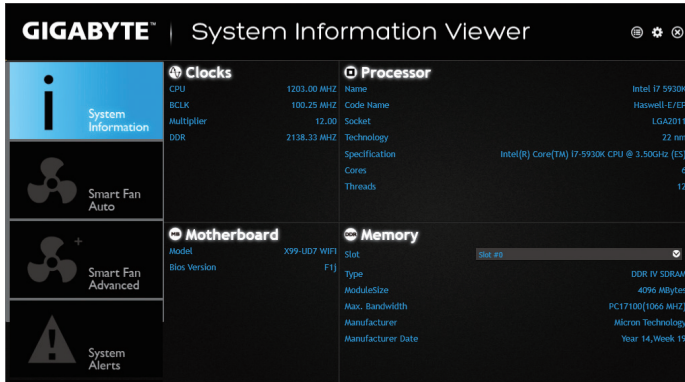

## 5-2-2 System Information Viewer

GIGABYTE System Information Viewer allows you to monitor and adjust the fan speed in the operating system. You can also display the hardware monitor information on the desktop to view the system status at any time.

### The System Information Viewer Interface



### Tabs Information

Tab	Description
	The <b>System Information</b> tab provides information on the installed CPU and motherboard and the BIOS version.
	The <b>Smart Fan Auto</b> tab allows you to specify a Smart Fan mode.
	The <b>Smart Fan Advance</b> tab allows you to adjust the smart fan speed. The fans will run at different speeds according to system temperatures. Using the <b>Smart Fan</b> option you can adjust the fan's workload according system temperatures or you can fix the fan speeds using the <b>RPM Fixed Mode</b> option. Click the <b>Calibrate</b> button and the fan speed will be shown in relation to overall fan workload after calibration. The <b>Reset</b> button can revert the fan settings back to the last saved values.
	The <b>System Alerts</b> tab allows you to monitor hardware temperature, voltage and fan speed, and set temperature/fan speed alarm.
	The <b>Record</b> tab allows you to record changes in system voltages, temperatures, and fan speeds. Please note, the recording will stop if you exit the <b>Record</b> tab during the recording process.



The speed control function requires the use of a fan with fan speed control design.

### 5-2-3 EZ Setup

The GIGABYTE EZ Setup utility includes the following 'EZ' setups applications that will offer greatly simplified install and configuration procedures: Disk Mode Switch, EZ Smart Response, and XHD.

#### Disk Mode Switch

Disk Mode Switch allows you to switch the operating mode for your hard drive even after it's been installed with an operating system. Supported operating modes include IDE, AHCI, and RAID. You can select a disk mode and restart your computer after the selection.



- Native UEFI mode is not supported.
- Be sure to reinstall the Intel® Rapid Storage Technology utility after you switch the disk mode.

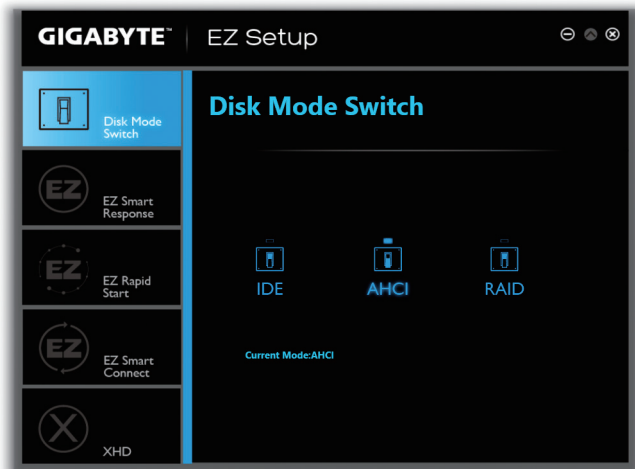

## EZ Smart Response

### A. System Requirements

1. An Intel® Chipset-based motherboard supporting this feature
2. Intel® Core series processor
3. Intel® SATA controllers set to RAID mode
4. Intel® Rapid Storage Technology utility installed<sup>(Note 1)</sup>
5. A conventional SATA disk and an SSD<sup>(Note 2)</sup>
6. Windows 7 with SP1/Windows 8/Windows 8.1<sup>(Note 3)</sup>



If you have installed the operating system before configuring the Smart Response Technology, all original data on the SSD will be lost once you enable RAID mode<sup>(Note 4)</sup>. It is recommended that you back up the hard disk before enabling the Smart Response Technology.

### B. Using EZ Smart Response

Select **EZ Smart Response** and click **Create**.

To disable this function, click **Delete**.

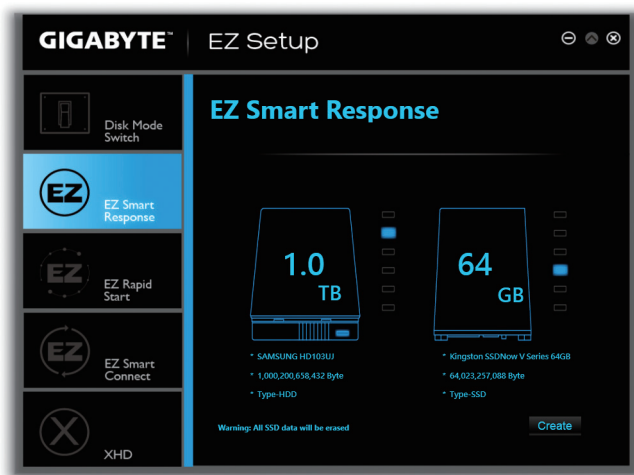

(Note 1) Before start, make sure you have installed the Intel® Rapid Storage Technology utility (version 11.5 or above).

(Note 2) The SSD works as a cache of the hard disk. The maximum cache memory size is 64 GB. If you use an SSD larger than 64 GB, the space beyond 64 GB can still be used for storing your data.

(Note 3) The operating system must be installed to the SATA disk.

(Note 4) Regardless of the BIOS settings, be it IDE or AHCI mode, the system will be forced to RAID mode.

## XHD

With GIGABYTE XHD <sup>(Note 1)</sup>, users can quickly configure a RAID-ready system for RAID 0 or RAID 1 when a new SATA drive is added. All with a simple click of a button, XHD helps to enhance your hard drive read/write performance without the need for complex and time-consuming configurations.

### A. System Requirements

1. An Intel® Chipset motherboard supporting RAID
2. Intel® SATA controllers set to RAID mode
3. Intel® Rapid Storage Technology utility installed
4. Windows 7 with SP1/Windows 8/Windows 8.1
5. Intel® SATA controller driver installed

### B. Using XHD

Select **XHD** and click **Create RAID 0** or **Create RAID 1** based on your need <sup>(Note 2)</sup>.

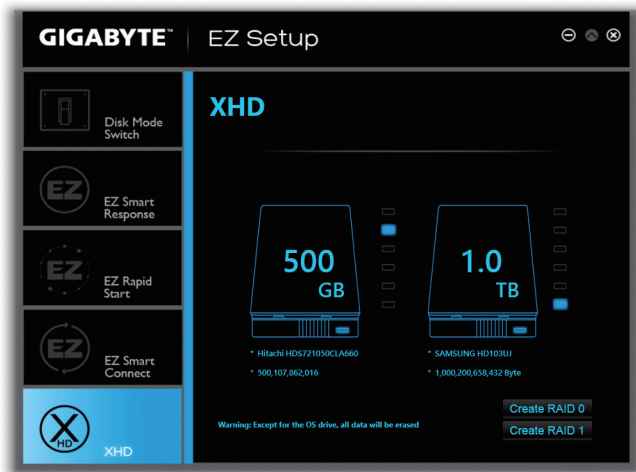

(Note 1) The XHD utility only supports the SATA connectors controlled by the Intel® Chipset.

(Note 2) Except for the operating system drive, all data on other hard drive will be deleted. Back up your data before using the XHD utility.

## 5-2-4 Fast Boot

Through the simple GIGABYTE Fast Boot<sup>(Note 1)</sup> interface, you can enable or change the Fast Boot or Next Boot After AC Power Loss setting right in the operating system.

### The Fast Boot Interface

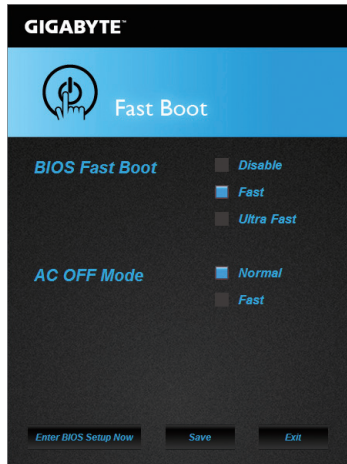

### Using Fast Boot

- **BIOS Fast Boot:**

This option is the same as the **Fast Boot** option<sup>(Note 2)</sup> in BIOS Setup. It allows you to enable or disable the fast boot function to shorten OS boot time.

- **AC OFF Mode:**

This option is the same as the **Next Boot After AC Power Loss** option<sup>(Note 2)</sup> in BIOS Setup. It allows you to select the system bootup mode upon the return of an AC power loss. (This mode is configurable only when **BIOS Fast Boot** is set to **Fast** or **Ultra Fast**.)

After you configure the setting, click **Save** to save and click **Exit**. The settings will take effect on next boot. If you click the **Enter BIOS Setup Now** button, the system will restart and enter BIOS Setup immediately.

(Note 1) This function is supported by Windows 8.1/8 only.

(Note 2) For more details about this function, refer to Chapter 2, "BIOS Features."

## 5-2-5 Smart TimeLock

GIGABYTE Smart TimeLock allows you to effectively manage computer or Internet usage time with simple rules and options.

### The Smart TimeLock Interface

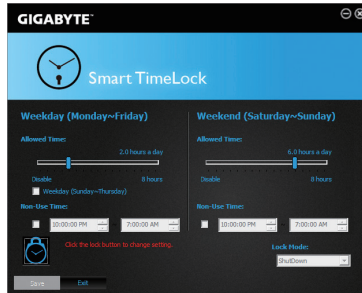

### Using Smart TimeLock

Click the lock icon  on the bottom left corner and enter the password <sup>(Note)</sup>. Set the time when a user can or cannot use your computer for weekdays and weekends. The **Lock Mode** on the bottom right corner allows you to choose to turn off the computer or only close the Internet connection during the specified time period. Click **Save** to save the settings and click **Exit** to exit.

An alert will appear 15 minutes and 1 minute prior to the default shutdown time. When the alert appears, you can enter the password to extend the usage time or click **Cancel** to close the alert. If you respond **Cancel**, you will be requested to enter the password to extend the usage time again when the default shutdown time arrives, or the computer will shutdown right away.

(Note) You can set the User Password in the system BIOS Setup program to prevent the system time being changed by other users.

## 5-2-6 Smart Recovery 2

Smart Recovery 2 allows you to back up a partition as an image file every hour. You can use these images to restore your system or files when needed.



The Smart Recovery 2 main menu:

Button	Description
Settings	Allows you to select the source and destination partition
Backup Now	Allows you to perform the backup immediately
File Recovery...	Allows you to recover your files from the backup image
System Recovery...	Allows you to recover your system from the backup image



- Smart Recovery 2 only supports NTFS file system.
- You need to select the destination partition in **Settings** the first time you use Smart Recovery 2.
- The Backup Now button will be available only after you log in Windows for ten minutes.
- Select the **Always run on next reboot** checkbox to automatically enable Smart Recovery2 after system reboot.



### Creating a backup:

Click the **Settings** button on the main menu. In the **Settings** dialog box, select the source partition and destination partition and click **OK**. The initial backup will start after 10 minutes and regular backup will be performed hourly. Note: By default, all partitions on the system drive are selected as the backup source. The backup destination cannot be on the same partition as the backup source.

### Saving the backup to a network location:

If you want to save the backup to a network location, select **Browse network location**. Make sure your computer and the computer where you want to save the backup are in the same domain. Choose the network location where you want to store the backup and enter the user name and password. Follow the on-screen instructions to complete.

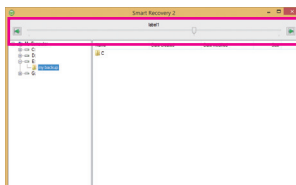

### Recovering a file:

Click the **File Recovery** button on the main menu. Use the time slider on the top of the popped out window to select a previous backup time. The right pane will display the backed-up partitions in the backup destination (in the **My Backup** folder). Browse to the file you want and copy it.



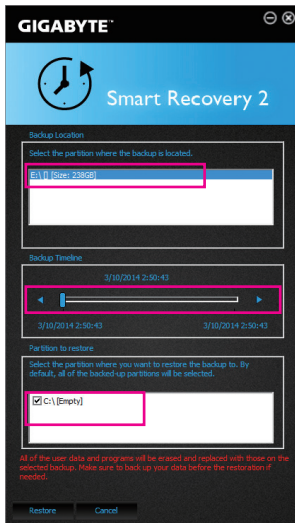

## Recovering your system with Smart Recovery 2:

Steps:

1. Click the **System Recovery** button on the main menu.
2. Select the location where your backup is saved.
3. Use the time slider to select a time point.
4. Select a partition backup created on the selected time point and click **Restore**.
5. Confirm whether to restart your system to proceed with the restore immediately or later. Once you respond "Yes" the system will restart to the Windows recovery environment. Follow the onscreen instructions to restore your system.



All of your files and programs will be deleted and replaced with those on the selected backup. If needed, be sure to make a copy of your data before the restore.

## 5-2-7 USB Blocker

GIGABYTE USB Blocker provides you with an easy-to-use interface that allows you to block certain USB device types on your PC. Devices classes that are blocked will be ignored by the operating system.

### The USB Blocker Interface

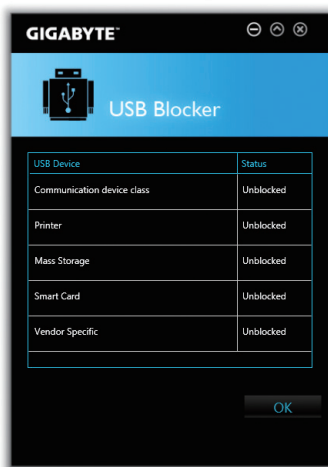

### Using USB Blocker

Select the class of USB device that you would like to block or unblocked. Double left-click to change the **Blocked** or **Unblocked** status and click **OK**. Then enter your password and click **OK** to complete.

## 5-2-8 Ambient LED

GIGABYTE Ambient LED allows you to enable or change the display mode for the onboard audio LED and rear panel I/O shield LED <sup>(Note)</sup> while in the Windows environment.

### The Ambient LED Interface

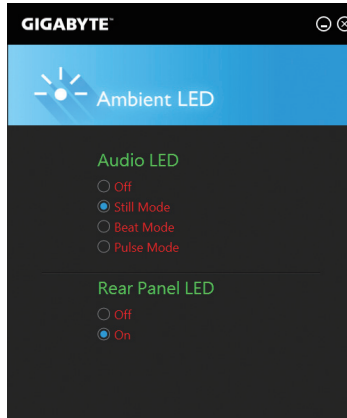

### Using Ambient LED

- **Audio LED (display mode of the onboard audio LED):**
  - Off** -- Disables this function.
  - Still Mode** -- The LED stays constantly on.
  - Beat Mode** -- The brightness of the LED changes according to music rhythm.
  - Pulse Mode** -- The brightness of the LED changes slowly and smoothly like breath.
- **Rear panel LED (display mode of the rear panel I/O shield LED) <sup>(Note)</sup>:**
  - Off** -- Disables this function.
  - On** -- The LED will light and follow the behavior of the onboard audio LED.

(Note) This function only works for motherboards with an I/O shield that has audio LED.

## 5-2-9 V-Tuner

GIGABYTE V-Tuner <sup>(Note 1)</sup> allows you to easily fine-tune your graphics card in the Windows environment. You can manually overclock the GPU and memory <sup>(Note 2)</sup> or adjust the fan speed and power settings. It also allows you to monitor your graphic card status at any time.

### The V-Tuner Interface

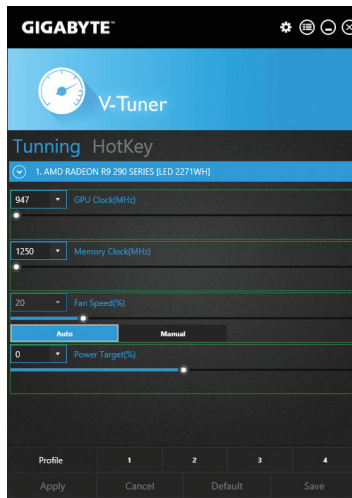

### Using V-Tuner

You can manually select the values of each item or use the sliders for adjustment and then click **Apply**. To set the fan speed you need to select **Manual** first. You can save the current settings to a profile and create up to 4 profiles. To check the graphics card status, you can click the  icon on the top right corner.

(Note 1) Before using V-Tuner, be sure to install the graphics card driver first.

(Note 2) Adjustable items may vary by graphics cards.

## 5-2-10 Smart Switch

GIGABYTE Smart Switch provides you with the conventional Windows start menu, allowing you to easily access to the apps that you frequently use. You can also select the default screen displayed after you enter Windows.

### The Smart Switch Interface

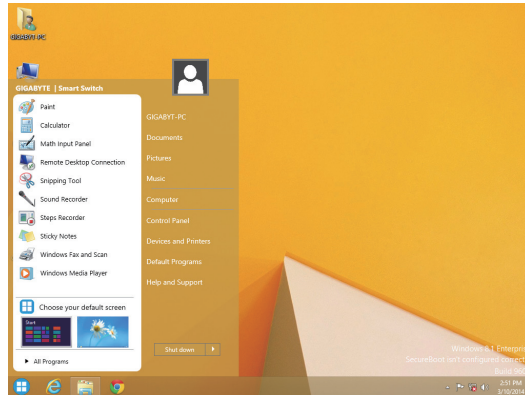

### Using Smart Switch

The Smart Switch icon  will appear on the bottom left corner of the traditional Windows desktop screen after Smart Switch is installed. Left-click the icon to see the screen as that shown above and you can set the default screen displayed after you enter Windows.

## 5-2-11 Cloud Station Server

GIGABYTE Cloud Station Server is composed of several GIGABYTE's unique apps that allow your smart phone/tablet device to communicate, share resources, and control desktop PCs via wireless connection.

### Before You Begin:

- To use the HomeCloud, GIGABYTE Remote, and Remote OC functions, you must install GIGABYTE Cloud Station on your smart phone/tablet device as well. (For Android system, please download the app from Google Play; for iOS system, please download it from App Store.)<sup>(Note 1)</sup>
- Your smart phone/tablet device must have Android 4.0/iOS 6.0 or above version.
- The first time you use HomeCloud, GIGABYTE Remote, and Remote OC, you must click **Login with Google** or **Login with Facebook** to sign in with your Google or Facebook account. Be sure to use the same account to sign in to the three apps on your smart phone/tablet device as well.

### HomeCloud

HomeCloud allows you to share the files<sup>(Note 2)</sup> between your smart phone/tablet device and computer or back up the files from the device to the computer.

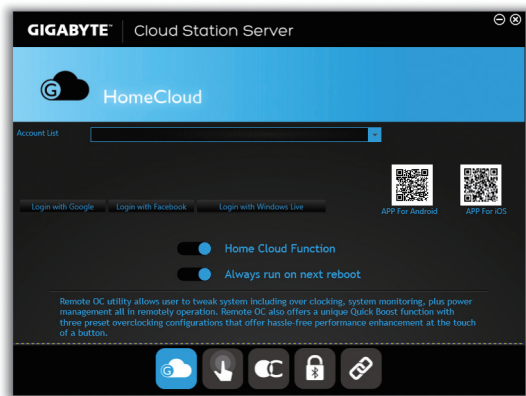

### The HomeCloud Interface:

#### Using HomeCloud

##### Step 1:

Launch HomeCloud on your computer and click **Login with Google** or **Login with Facebook** to sign in with your Google or Facebook account or select the account on the **Account List**. Then enable **HomeCloud Function**. To automatically enable this function after system reboot, enable **Always run on next reboot**.

##### Step 2:

Run GIGABYTE Cloud Station on your smart phone/tablet device, sign in with the same account you use for HomeCloud on your computer. Tap on **HomeCloud** to perform the following functions:

(Note 1) You can use your smart phone/tablet device to scan the QR code on the HomeCloud UI to link to the download page of the GIGABYTE Cloud Station on App Store or Google Play.

(Note 2) For iOS systems, the file types are limited to image/video files.

**On the Computer:**

Option	Function
Account List	Displays currently signed in account(s).
Remove	Remove the selected account.
Share Folder	Displays the shared folder directory of the currently signed in account.
Open Folder	Access the shared folder of the currently signed in account.

**On the Smart Phone/Tablet Device:**

Option	Function
All Picture Files	File Upload: Tap on the folder, browse and select the files inside. Tap on the menu icon and select <b>Upload selected Files</b> to upload the files to your computer. To open a file, tap on it for about 1 second (for iOS systems only). File Download: Tap on the folder and then tap on the menu icon, select <b>Download Files</b> . You can browse the files and select the files that you want to download to your smart phone/tablet device.
All Music Files	
All Video Files	
All Files	
User Contacts	Tap on the folder and then tap on the menu icon to use the options including <b>Backup to remote, Restore From remote, View Remote Contact, and Reselect Computers</b> .
Call Log	

## GIGABYTE Remote

GIGABYTE Remote allows you to use your smart phone/tablet device to remotely control the mouse/keyboard/Windows Media Player on your computer.

### The GIGABYTE Remote Interface

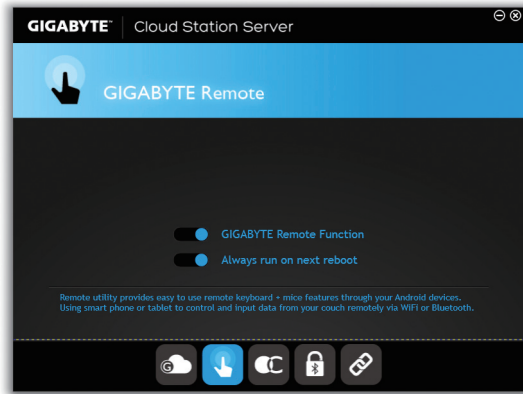

### Using GIGABYTE Remote

Step 1:

Launch GIGABYTE Remote on your computer and enable **GIGABYTE Remote Function**. To automatically enable this function after system reboot, enable **Always run on next reboot**.

Step 2:

Run GIGABYTE Cloud Station on your smart phone/tablet device, sign in with the same account you use for HomeCloud on your computer. Tap on **Remote Control** to perform the following remote controls:

#### On the Smart Phone/Tablet Device:

Option	Function
Mouse	Remotely perform mouse functionalities including dragging, right/left-clicking, and holding the mouse left button.
Keyboard	Remotely control your keyboard such as text input (tap on Real-Time Mode to type texts) or deletion.
Media	Remotely configure and control the currently running Windows Media Player application on your computer.



## Remote OC

Remote OC provides you with remote control options including overclocking and system tweaking, system monitoring plus the ability to also remotely power down/reset the PC when needed.

### The Remote OC Interface



## Using Remote OC

Step 1:

Launch Remote OC on your computer and enable **Remote OC Function**. To automatically enable this function after system reboot, enable **Always run on next reboot**.

Step 2:

Run GIGABYTE Cloud Station on your smart phone/tablet device, sign in with the same account you use for HomeCloud on your computer. Tap on **Remote OC** to perform the following functions:

### On the Smart Phone/Tablet Device:

Option	Function
Tuner	Allows you to change CPU/memory frequency and voltage settings.
INFO	Displays the system information, including the CPU, motherboard, and memory.
HW MONIT	Allows you to monitor system temperatures, voltages, and fan speeds.
QUICK BOOST	Provides you with three preset overclocking configurations.
CONTROL	Allows you to remotely reboot or shut down your computer.

## AutoGreen

AutoGreen is an easy-to-use tool that provides users with simple options to enable system power savings via a Bluetooth-enabled smart phone/tablet device. When the device is out of the range of the computer's Bluetooth receiver, the system will enter the specified power saving mode. Before using this app, you need to turn on Bluetooth on both your computer and smart phone/tablet device.

### The AutoGreen Interface



#### Bluetooth Devices Tab:

The **Bluetooth** tab allows you to pair your smart phone/tablet device with the Bluetooth receiver on your computer. Press **Refresh** to let AutoGreen search for the Bluetooth devices around you. From the displayed list, select your smart phone/tablet device and a message which says "Tap to set up your.." will appear. Click to confirm. A message will appear on both your computer and smart phone/tablet device prompting you to compare the passcodes on the two devices. Confirm to complete the pairing process.

- **Device Scan Time:**

Set the length of time that AutoGreen will search for your smart phone/tablet device, ranging from 2 to 30 seconds.

- **Rescan Times:**

Set how many times AutoGreen will search for your smart phone/tablet device if it does not detect it, ranging from 2 to 10 times. If the device is still not detected, the system will enter the selected power saving mode.

#### Control Tab:

The **Control** tab allows you to select a system power saving mode.

Button	Description
Standby	Enters Power on Suspend mode
Suspend	Enters Suspend to RAM mode
Hibernate	Enters Suspend to Disk mode
Disable	Disables this function

#### User Account Tab:

On the **User Account** tab, you can enter your Windows user account password and confirm. Later, when you awaken your system from Suspend/Hibernate mode you can enter Windows directly without entering the user account password.

(Note) Once your smart phone/tablet device has been paired with your AutoGreen-enabled computer, you'll not be able to use it to connect to other Bluetooth device(s).

## HotSpot

HotSpot turns your computer into a virtual wireless access point and allows you to share your connection with your other wireless devices. Make sure your computer has been connected to a network and Wi-Fi is enabled.

### The HotSpot Interface

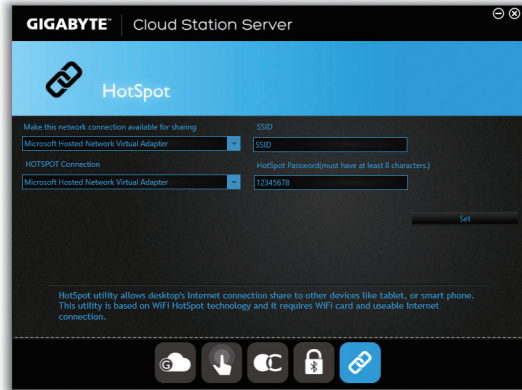

### Using HotSpot:

Configuring your computer:

The options are as follows. Make sure to click **Start** to complete.

- **Shared Connection:**  
Select a currently running network connection you want to share.
- **HOTSPOT Connection:**  
Select a network virtual adapter. If there are more than one Wi-Fi card on your computer, you need to select the one you want to use from the list.
- **HotSpot SSID:**  
The hotspot SSID name. You can keep the default name or create your own one.
- **HotSpot Password:**  
The password is required when other wireless devices want to access the Internet through the virtual wireless access point. You can keep the default name or create your own one. The password must have at least 8 characters and cannot be empty.

### Sharing your connection with other wireless devices:

First make sure Wi-Fi is enabled on the wireless devices. Then browse to the network configuration screen, search for available Wi-Fi networks, and tap the name of your virtual wireless access point, enter the password, and confirm.



# Chapter 6 Appendix

## 6-1 Configuring Audio Input and Output

### 6-1-1 Configuring 2/4/5.1/7.1-Channel Audio

The motherboard provides five audio jacks on the back panel which support 2/4/5.1/7.1-channel <sup>(Note)</sup> audio. The picture to the right shows the default audio jack assignments.



The integrated HD (High Definition) audio provides jack retasking capability that allows the user to change the function for each jack through the audio driver. (Supported functions for each jack may vary based on hardware specification.)



- To install a microphone, connect your microphone to the Mic in jack and manually configure the jack for microphone functionality.
- To configure 4/5.1/7.1-channel audio, you have to retask one of the audio jacks to be Side speaker out through the audio driver.
- Audio signals will be present on both of the front and back panel audio connections simultaneously. If you want to mute the back panel audio (only supported when using an HD front panel audio module), refer to instructions on the next page.

#### High Definition Audio (HD Audio)

HD Audio includes multiple high quality digital-to-analog converters (DACs) and features multistreaming capabilities that allow multiple audio streams (in and out) to be simultaneously processed. For example, users can listen to MP3 music, have an Internet chat, make a telephone call over the Internet, and etc. all at the same time.

#### A. Configuring Speakers

(The following instructions use Windows 8.1 as the example operating system.)

Step 1:

After installing the audio driver, restart your computer. Then switch to Windows desktop mode. The **HD Audio Manager** icon  will appear in the notification area. Double-click the icon to access the **HD Audio Manager**.

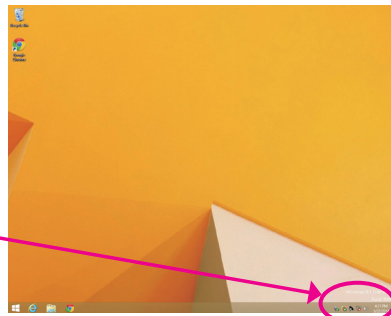

(Note) 2/4/5.1/7.1-Channel Audio Configurations:

Refer to the following for multi-channel speaker configurations.

- 2-channel audio: Headphone or Line out.
- 4-channel audio: Front speaker out and Rear speaker out.
- 5.1-channel audio: Front speaker out, Rear speaker out, and Center/Subwoofer speaker out.
- 7.1-channel audio: Front speaker out, Rear speaker out, Center/Subwoofer speaker out, and Side speaker out.

Step 2:

Connect an audio device to an audio jack. The **The current connected device is** dialog box appears. Select the device according to the type of device you connect. Then click **OK**.



Step 3:

On the **Speakers** screen, click the **Speaker Configuration** tab. In the **Speaker Configuration** list, select **Stereo**, **Quadraphonic**, **5.1 Speaker**, or **7.1 Speaker** according to the type of speaker configuration you wish to set up. Then the speaker setup is completed.



## B. Configuring Sound Effect

You may configure an audio environment on the **Sound Effects** tab.

## C. Activating an AC'97 Front Panel Audio Module

If your chassis provides an AC'97 front panel audio module, to activate the AC'97 functionality, click the **Tool** icon  on the right bottom of the screen. On the **Connector Settings** dialog box, select the **Disable front panel jack detection** check box. Click **OK** to complete.

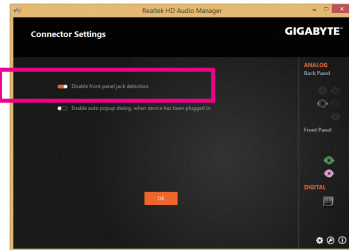

## D. Muting the Back Panel Audio (For HD Audio Only)

Click **Device advanced settings** icon  on the right bottom of the screen to open the **Device advanced settings** dialog box. Select the **Mute the rear output device, when a front headphone plugged in** check box. Click **OK** to complete.

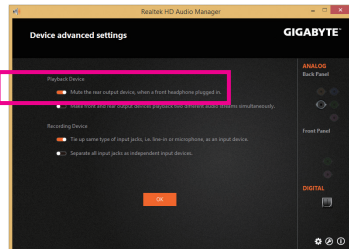

## 6-1-2 Configuring S/PDIF Out

The S/PDIF Out jack can transmit audio signals to an external decoder for decoding to get the best audio quality.

### 1. Connecting a S/PDIF Out Cable:

Connect a S/PDIF optical cable to an external decoder for transmitting the S/PDIF digital audio signals.

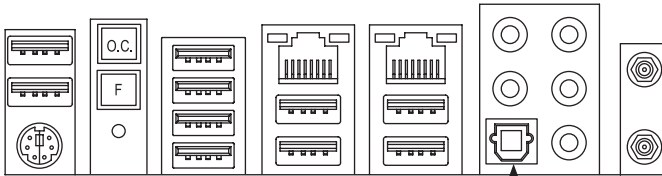

Connects to a S/PDIF optical cable

### 2. Configuring S/PDIF Out:

On the **Digital Output(Optical)** screen <sup>(Note)</sup>, click the **Default Format** tab and then select the sample rate and bit depth. Click **OK** to complete.

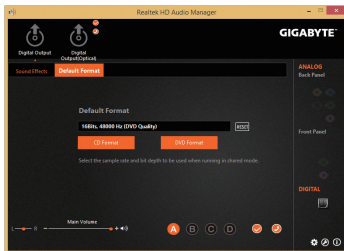

(Note) Enter the **Digital Output(Optical)** screen to configure further settings if you use the S/PDIF Out connector(s) on the back panel for digital audio output or enter the **Digital Output** screen if you use the internal S/PDIF Out connector (SPDIF\_O) for digital audio output.

## 6-1-3 Configuring Microphone Recording

Step 1:

Switch to Windows desktop mode. The **HD Audio Manager** icon  will appear in the notification area. Double-click the icon to access the **HD Audio Manager**.

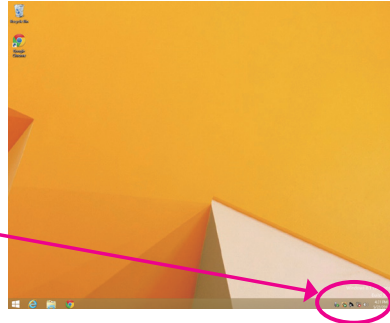
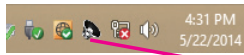

Step 2:

Connect your microphone to the Mic in jack (pink) on the back panel or the Mic in jack (pink) on the front panel. Then configure the jack for microphone functionality. Note: The microphone functions on the front panel and back panel cannot be used at the same time.

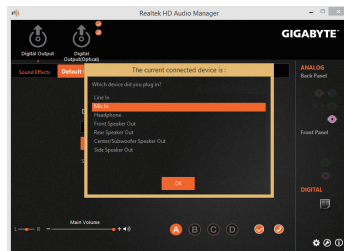

Step 3:

Go to the **Microphone** screen. Do not mute the recording volume, or you'll not be able to record the sound. To hear the sound being recorded during the recording process, do not mute the playback volume. It is recommended that you set the volumes at a middle level.

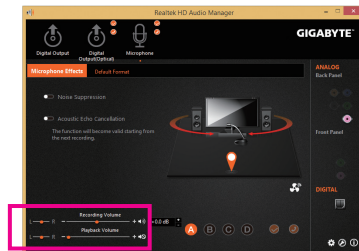

Step 4:

To raise the recording and playback volume for the microphone, you can set the Microphone Boost level on the right of the **Recording Volume** slider.





Step 5:

To open the **Sound Recorder**, move the mouse cursor to the bottom left corner of the screen, click the **Start** icon to switch to the **Start** screen (or press the Windows button on the keyboard). Click the  icon on the bottom left corner of the screen to access the **Apps** screen.



Step 6:

On this screen, click **Sound Recorder** for audio recording.

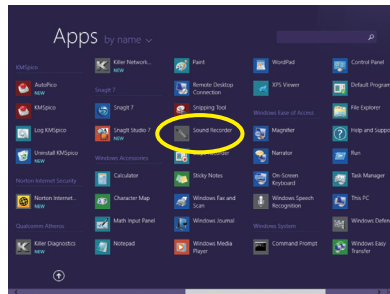

### \* Enabling Stereo Mix

If the HD Audio Manager does not display the recording device you wish to use, refer to the steps below. The following steps explain how to enable Stereo Mix (which may be needed when you want to record sound from your computer).

Step 1:

Switch to Windows desktop mode. Locate the  icon in the notification area and right-click on this icon. Select **Recording Devices**.

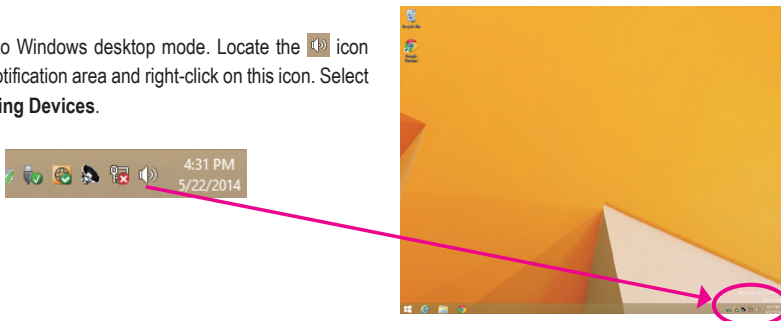

Step 2:

On the **Recording** tab, right-click on an empty space and select **Show Disabled Devices**.

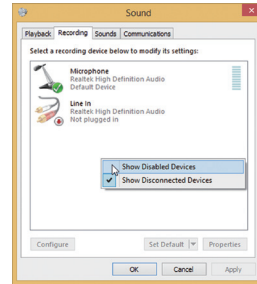

Step 3:

When the **Stereo Mix** item appears, right-click on this item and select **Enable**. Then set it as the default device.

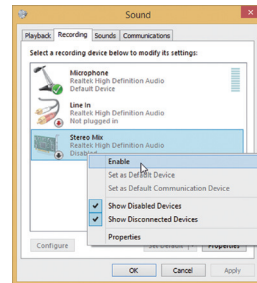

Step 4:

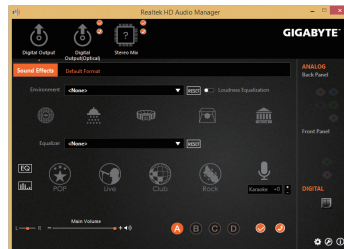

Now you can access the **HD Audio Manager** to configure **Stereo Mix** and use **Sound Recorder** to record the sound.

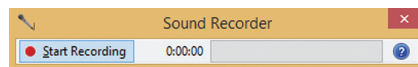

## 6-1-4 Using the Sound Recorder



### A. Recording Sound

1. Make sure you have connected the sound input device (e.g. microphone) to the computer.
2. To record the audio, click the **Start Recording** button .
3. To stop recording audio, click the **Stop Recording** button .

Be sure to save the recorded audio file upon completion.

### B. Playing the Recorded Sound

You can play your recording in a digital media player program that supports your audio file format.

## 6-2 Troubleshooting

### 6-2-1 Frequently Asked Questions

To read more FAQs for your motherboard, please go to the **Support & Downloads\FAQ** page on GIGABYTE's website.

Q: Why is the light of my keyboard/optical mouse still on after the computer shuts down?

A: Some motherboards provide a small amount of standby power after the computer shuts down and that's why the light is still on.

Q: How do I clear the CMOS values?

A: For motherboards that have a Clear CMOS button, press this button to clear the CMOS values (before doing this, please turn off the computer and unplug the power cord). For motherboards that have a Clear CMOS jumper, refer to the instructions in Chapter 1 to short the jumper to clear the CMOS values. If your board doesn't have this jumper/button, refer to the instructions on the motherboard battery in Chapter 1. You can temporarily remove the battery from the battery holder to stop supplying power to the CMOS, which will clear the CMOS values after about one minute.

Q: Why do I still get a weak sound even though I have turned my speaker to the maximum volume?

A: Make sure your speaker is equipped with an internal amplifier. If not, try a speaker with power/amplifier.

## 6-2-2 Troubleshooting Procedure

If you encounter any troubles during system startup, follow the troubleshooting procedure below to solve the problem.

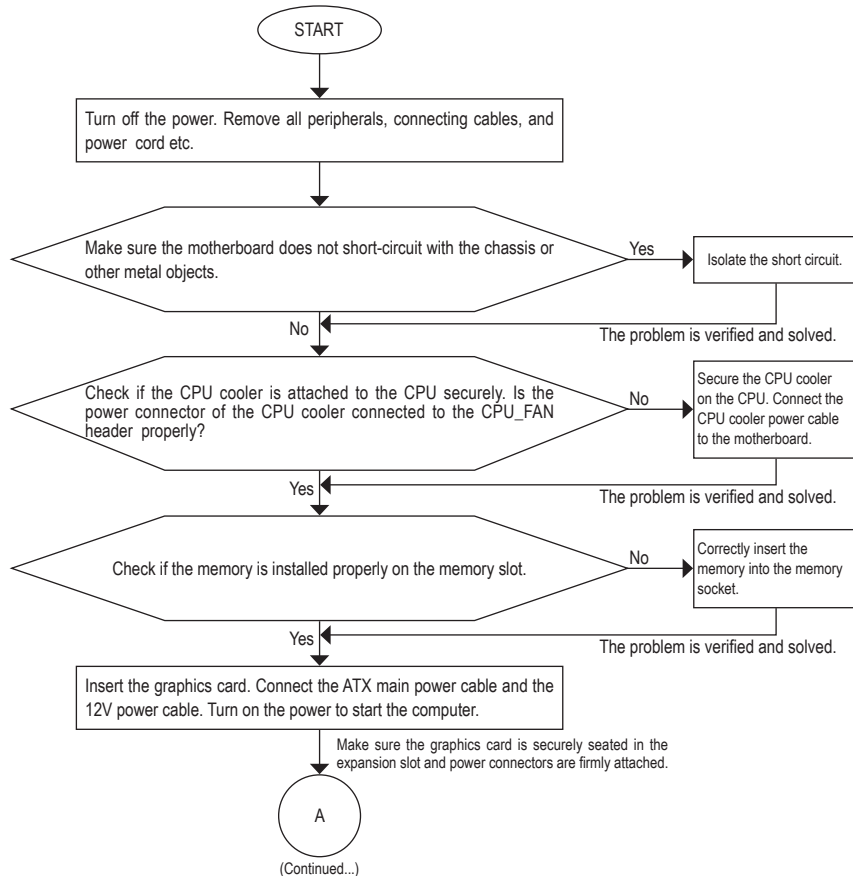

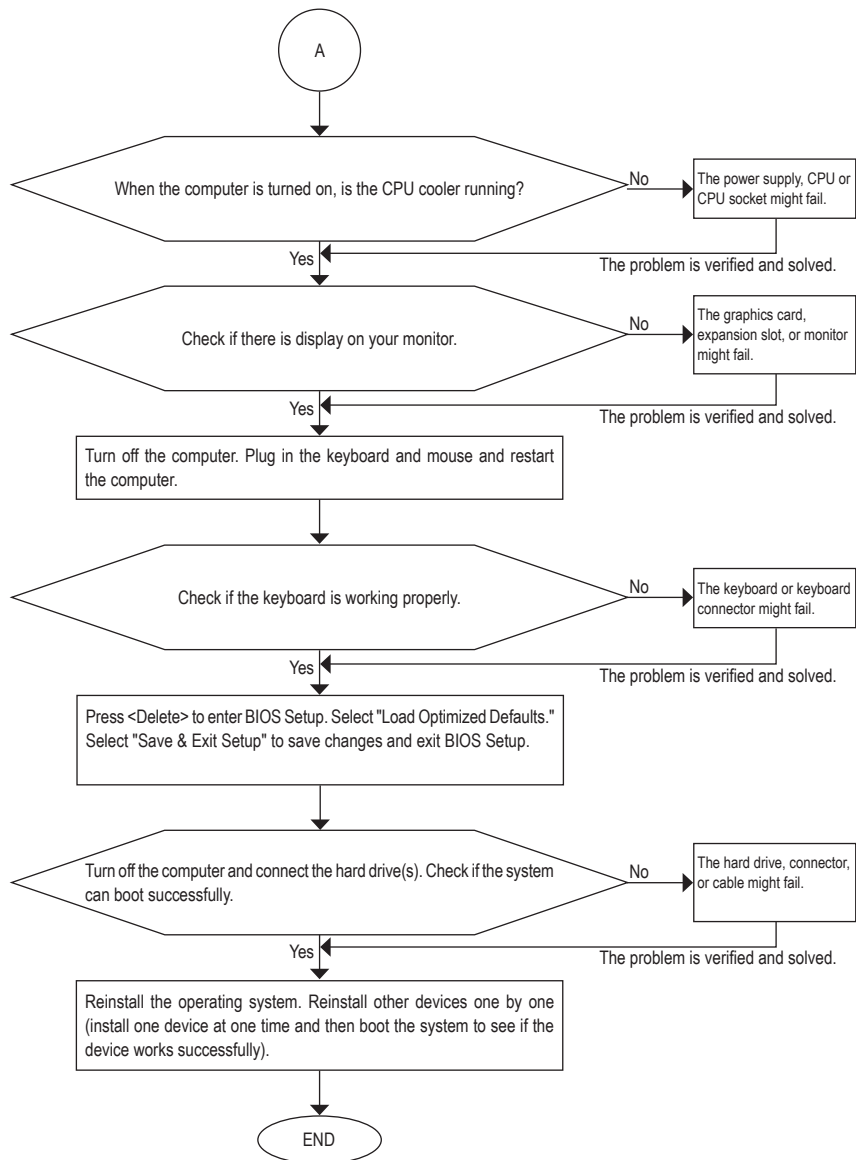

If the procedure above is unable to solve your problem, contact the place of purchase or local dealer for help. Or go to the **Support & Downloads\Technical Support** page to submit your question. Our customer service staff will reply you as soon as possible.

## 6-3 Debug LED Codes

### Regular Boot

Code	Description
10	PEI Core is started.
11	Pre-memory CPU initialization is started.
12~14	Reserved.
15	Pre-memory North-Bridge initialization is started.
16~18	Reserved.
19	Pre-memory South-Bridge initialization is started.
1A~2A	Reserved.
2B~2F	Memory initialization.
31	Memory installed.
32~36	CPU PEI initialization.
37~3A	IOH PEI initialization.
3B~3E	PCH PEI initialization.
3F~4F	Reserved.
60	DXE Core is started.
61	NVRAM initialization.
62	Installation of the PCH runtime services.
63~67	CPU DXE initialization is started.
68	PCI host bridge initialization is started.
69	IOH DXE initialization.
6A	IOH SMM initialization.
6B~6F	Reserved.
70	PCH DXE initialization.
71	PCH SMM initialization.
72	PCH devices initialization.
73~77	PCH DXE initialization (PCH module specific).
78	ACPI Core initialization.
79	CSM initialization is started.
7A~7F	Reserved for AML use.
80~8F	Reserved for OEM use (OEM DXE initialization codes).
90	Phase transfer to BDS (Boot Device Selection) from DXE.
91	Issue event to connect drivers.

<b>Code</b>	<b>Description</b>
92	PCI Bus initialization is started.
93	PCI Bus hot plug initialization.
94	PCI Bus enumeration for detecting how many resources are requested.
95	Check PCI device requested resources.
96	Assign PCI device resources.
97	Console Output devices connect (ex. Monitor is lighted).
98	Console input devices connect (ex. PS2/USB keyboard/mouse are activated).
99	Super IO initialization.
9A	USB initialization is started.
9B	Issue reset during USB initialization process.
9C	Detect and install all currently connected USB devices.
9D	Activated all currently connected USB devices.
9E~9F	Reserved.
A0	IDE initialization is started.
A1	Issue reset during IDE initialization process.
A2	Detect and install all currently connected IDE devices.
A3	Activated all currently connected IDE devices.
A4	SCSI initialization is started.
A5	Issue reset during SCSI initialization process.
A6	Detect and install all currently connected SCSI devices.
A7	Activated all currently connected SCSI devices.
A8	Verify password if needed.
A9	BIOS Setup is started.
AA	Reserved.
AB	Wait user command in BIOS Setup.
AC	Reserved.
AD	Issue Ready To Boot event for OS Boot.
AE	Boot to Legacy OS.
AF	Exit Boot Services.
B0	Runtime AP installation begins.
B1	Runtime AP installation ends.
B2	Legacy Option ROM initialization.
B3	System reset if needed.

Code	Description
B4	USB device hot plug-in.
B5	PCI device hot plug.
B6	Clean-up of NVRAM.
B7	Reconfigure NVRAM settings.
B8~BF	Reserved.
C0~CF	Reserved.

### S3 Resume

Code	Description
E0	S3 Resume is started (called from DXE IPL).
E1	Fill boot script data for S3 resume.
E2	Initializes VGA for S3 resume.
E3	OS S3 wake vector call.

### Recovery

Code	Description
F0	Recovery mode will be triggered due to invalid firmware volume detection.
F1	Recovery mode will be triggered by user decision.
F2	Recovery is started.
F3	Recovery firmware image is found.
F4	Recovery firmware image is loaded.
F5~F7	Reserved for future AMI progress codes.

### Error

Code	Description
50~55	Memory initialization error occurs.
56	Invalid CPU type or speed.
57	CPU mismatch.
58	CPU self test failed or possible CPU cache error.
59	CPU micro-code is not found or micro-code update is failed.
5A	Internal CPU error.
5B	Reset PPI is failed.
5C~5F	Reserved.
D0	CPU initialization error.
D1	IOH initialization error.



<b>Code</b>	<b>Description</b>
D2	PCH initialization error.
D3	Some of the Architectural Protocols are not available.
D4	PCI resource allocation error. Out of Resources.
D5	No Space for Legacy Option ROM initialization.
D6	No Console Output Devices are found.
D7	No Console Input Devices are found.
D8	It is an invalid password.
D9~DA	Can't load Boot Option.
DB	Flash update is failed.
DC	Reset protocol is failed.
DE~DF	Reserved.
E8	S3 resume is failed.
E9	S3 Resume PPI is not found.
EA	S3 Resume Boot Script is invalid.
EB	S3 OS Wake call is failed.
EC~EF	Reserved.
F8	Recovery PPI is invalid.
F9	Recovery capsule is not found.
FA	Invalid recovery capsule.
FB~FF	Reserved.

# Regulatory Statements

## Regulatory Notices

This document must not be copied without our written permission, and the contents there of must not be imparted to a third party nor be used for any unauthorized purpose. Contravention will be prosecuted. We believe that the information contained herein was accurate in all respects at the time of printing. GIGABYTE cannot, however, assume any responsibility for errors or omissions in this text. Also note that the information in this document is subject to change without notice and should not be construed as a commitment by GIGABYTE.

## Our Commitment to Preserving the Environment

In addition to high-efficiency performance, all GIGABYTE motherboards fulfill European Union regulations for RoHS (Restriction of Certain Hazardous Substances in Electrical and Electronic Equipment) and WEEE (Waste Electrical and Electronic Equipment) environmental directives, as well as most major worldwide safety requirements. To prevent releases of harmful substances into the environment and to maximize the use of our natural resources, GIGABYTE provides the following information on how you can responsibly recycle or reuse most of the materials in your "end of life" product.

## Restriction of Hazardous Substances (RoHS) Directive Statement

GIGABYTE products have not intended to add and safe from hazardous substances (Cd, Pb, Hg, Cr+6, PBDE and PBB). The parts and components have been carefully selected to meet RoHS requirement. Moreover, we at GIGABYTE are continuing our efforts to develop products that do not use internationally banned toxic chemicals.

## Waste Electrical & Electronic Equipment (WEEE) Directive Statement

GIGABYTE will fulfill the national laws as interpreted from the 2002/96/EC WEEE (Waste Electrical and Electronic Equipment) directive. The WEEE Directive specifies the treatment, collection, recycling and disposal of electric and electronic devices and their components. Under the Directive, used equipment must be marked, collected separately, and disposed of properly.

## WEEE Symbol Statement



The symbol shown below is on the product or on its packaging, which indicates that this product must not be disposed of with other waste. Instead, the device should be taken to the waste collection centers for activation of the treatment, collection, recycling and disposal procedure. The separate collection and recycling of your waste equipment at the time of disposal will help to conserve natural resources and ensure that it is recycled in a manner that protects human health and the environment.

For more information about where you can drop off your waste equipment for recycling, please contact your local government office, your household waste disposal service or where you purchased the product for details of environmentally safe recycling.

- ♦ When your electrical or electronic equipment is no longer useful to you, "take it back" to your local or regional waste collection administration for recycling.
- ♦ If you need further assistance in recycling, reusing in your "end of life" product, you may contact us at the Customer Care number listed in your product's user's manual and we will be glad to help you with your effort.

Finally, we suggest that you practice other environmentally friendly actions by understanding and using the energy-saving features of this product (where applicable), recycling the inner and outer packaging (including shipping containers) this product was delivered in, and by disposing of or recycling used batteries properly. With your help, we can reduce the amount of natural resources needed to produce electrical and electronic equipment, minimize the use of landfills for the disposal of "end of life" products, and generally improve our quality of life by ensuring that potentially hazardous substances are not released into the environment and are disposed of properly.

### **FCC Notice (U.S.A. Only)**

This equipment generates, uses, and can radiate radio frequency energy and, if not installed and used in accordance with the instructions, may cause harmful interference to radio communications. However, there is no guarantee that interference will not occur in a particular installation. If this equipment does cause harmful interference to radio or television reception, which can be determined by turning the equipment off and on, the user is encouraged to try to correct the interference by one or more of the following measures:

- Reorient or relocate the receiving antenna.
- Increase the separation between the equipment and receiver.
- Connect the equipment into an outlet on a circuit different from that to which the receiver is connected.
- Consult a dealer or experienced TV/radio technician for help.

Properly shielded and grounded cables and connectors must be used in order to meet FCC emission limits. Neither the Dealer nor the Manufacturer are responsible for any radio or television interference caused by using other than recommended cables and connectors or by unauthorized changes or modifications to this equipment. Unauthorized changes or modifications could void the user's authority to operate the equipment.

#### **CAUTION:**

Any changes or modifications not expressly approved by the grantee of this device could void the user's authority to operate the equipment.

### **Canada-Industry Canada (IC):**

This device complies with RSS210 of Industry Canada.

Cet appareil se conforme à RSS210 de Canada d'Industrie.

Caution: When using IEEE 802.11a wireless LAN, this product is restricted to indoor use due to its operation in the 5.15- to 5.25-GHz frequency range. Industry Canada requires this product to be used indoors for the frequency range of 5.15 GHz to 5.25 GHz to reduce the potential for harmful interference to co-channel mobile satellite systems. High power radar is allocated as the primary user of the 5.25- to 5.35-GHz and 5.65 to 5.85-GHz bands. These radar stations can cause interference with and/or damage to this device.

The maximum allowed antenna gain for use with this device is 6dBi in order to comply with the E.I.R.P limit for the 5.25- to 5.35 and 5.725 to 5.85 GHz frequency range in point-to-point operation.

This Class B digital apparatus complies with Canadian ICES-003, Issue 4, and RSS-210, No 4 (Dec 2000) and No 5 (Nov 2001).

"To prevent radio interference to the licensed service, this device is intended to be operated indoors and away from windows to provide maximum shielding. Equipment (or its transmit antenna) that is installed outdoors is subject to licensing."

Attention : l'utilisation d'un réseau sans fil IEEE802.11a est restreinte à une utilisation en intérieur à cause du fonctionnement dans la bande de fréquence 5.15-5.25 GHz. Industry Canada requiert que ce produit soit utilisé à l'intérieur des bâtiments pour la bande de fréquence 5.15-5.25 GHz afin de réduire les possibilités d'interférences nuisibles aux canaux co-existants des systèmes de transmission satellites. Les radars de puissances ont fait l'objet d'une allocation primaire de fréquences dans les bandes 5.25-5.35 GHz et 5.65-5.85 GHz. Ces stations radar peuvent créer des interférences avec ce produit et/ou lui être nuisible.

Le gain d'antenne maximum permissible pour une utilisation avec ce produit est de 6 dBi afin d'être conforme aux limites de puissance isotropique rayonnée équivalente (P.I.R.E.) applicable dans les bandes 5.25-5.35 GHz et 5.725-5.85 GHz en fonctionnement point-à-point.

Cet appareil numérique de la classe B est conforme à la norme NMB-003, No. 4, et CNR-210, No 4 (Dec 2000) et No 5 (Nov 2001).

« Pour empêcher que cet appareil cause du brouillage au service faisant l'objet d'une licence, il doit être utilisé à l'intérieur et devrait être placé loin des fenêtres afin de fournir un écran de blindage maximal. Si le matériel (ou son antenne d'émission) est installé à l'extérieur, il doit faire l'objet d'une licence. »

### **European Community Directive R&TTE Directive Compliance Statement:**

This equipment complies with all the requirements and other relevant provisions of Directive 1999/5/EC of the European Parliament and the Council of March 9, 1999 on Radio Equipment and Telecommunication Terminal Equipment (R&TTE).

This equipment is suitable for home and office use in all the European Community Member States and EFTA Member States.

The low band 5.15 -5.35 GHz is for indoor use only.

France:

Pour la France métropolitaine

2.400 - 2.4835 GHz (Canaux 1 à 13) autorisé en usage intérieur

2.400 - 2.454 GHz (canaux 1 à 7) autorisé en usage extérieur

Pour la Guyane et la Réunion

2.400 - 2.4835 GHz (Canaux 1 à 13) autorisé en usage intérieur

2.420 - 2.4835 GHz (canaux 5 à 13) autorisé en usage extérieur

Italy:

The use of these equipments is regulated by:

1. D.L.gs 1.8.2003, n. 259, article 104 (activity subject to general authorization) for outdoor use and article 105 (free use) for indoor use, in both cases for private use.
2. D.M. 28.5.03, for supply to public of RLAN access to networks and telecom services.

L'uso degli apparati è regolamentato da:

1. D.L.gs 1.8.2003, n. 259, articoli 104 (attività soggette ad autorizzazione generale) se utilizzati al di fuori del proprio fondo e 105 (libero uso) se utilizzati entro il proprio fondo, in entrambi i casi per uso private.
2. D.M. 28.5.03, per la fornitura al pubblico dell'accesso R-LAN alle reti e ai servizi di telecomunicazioni.

### **Taiwan NCC Wireless Statements / 無線設備警告聲明:**

低功率電波輻射性電機管理辦法

第十二條: 經型式認證合格之低功率射頻電機, 非經許可, 公司、商號或使用者均不得擅自變更頻率、加大功率或變更原設計之特性及功能。

第十四條: 低功率射頻電機之使用不得影響飛航安全及干擾合法通信; 經發現有干擾現象時, 應立即停用, 並改善至無干擾時方得繼續使用。

前項合法通信, 指依電信法規定作業之無線電通信。

低功率射頻電機須忍受合法通信或工業、科學及醫療用電波輻射性電機設備之干擾。

低功率射頻電機技術規範

4.7: 在5.25-5.35赫赫頻帶內操作之無線資訊傳輸設備, 限於室內使用。

### **Korea KCC NCC Wireless Statement:**

5.25GHz - 5.35 GHz 대역을 사용하는 무선 장치는 실내에서만 사용하도록 제한됩니다.

### **Japan Wireless Statement:**

5.15GHz帯 ~ 5.35GHz帯: 屋内のみの使用。



## Contact Us

---

### • GIGA-BYTE TECHNOLOGY CO., LTD.

Address: No.6, Baoqiang Rd., Xindian Dist.,  
New Taipei City 231, Taiwan  
TEL: +886-2-8912-4000  
FAX: +886-2-8912-4005  
Tech. and Non-Tech. Support (Sales/Marketing) :  
<http://esupport.gigabyte.com>  
WEB address (English): <http://www.gigabyte.com>  
WEB address (Chinese): <http://www.gigabyte.tw>

---

### • G.B.T. INC. - U.S.A.

TEL: +1-626-854-9338  
FAX: +1-626-854-9326  
Tech. Support: <http://esupport.gigabyte.com>  
Warranty Info: <http://rma.gigabyte.us>  
Web address: <http://www.gigabyte.us>

---

### • G.B.T. INC (USA) - Mexico

Tel: +1-626-854-9338 x 215 (Soporte de habla hispano)  
FAX: +1-626-854-9326  
Correo: [soporte@gigabyte-usa.com](mailto:soporte@gigabyte-usa.com)  
Tech. Support: <http://rma.gigabyte.us>  
Web address: <http://latam.giga-byte.com>

---

### • Giga-Byte SINGAPORE PTE. LTD. - Singapore

WEB address : <http://www.gigabyte.sg>

---

### • Thailand

WEB address : <http://th.giga-byte.com>

---

### • Vietnam

WEB address : <http://www.gigabyte.vn>

---

### • NINGBO G.B.T. TECH. TRADING CO., LTD. - China

WEB address : <http://www.gigabyte.cn>

#### Shanghai

TEL: +86-21-63400912

FAX: +86-21-63400682

#### Beijing

TEL: +86-10-62102838

FAX: +86-10-62102848

#### Wuhan

TEL: +86-27-87685981

FAX: +86-27-87579461

#### GuangZhou

TEL: +86-20-87540700

FAX: +86-20-87544306

#### Chengdu

TEL: +86-28-85483135

FAX: +86-28-85256822

#### Xian

TEL: +86-29-85531943

FAX: +86-29-85510930

#### Shenyang

TEL: +86-24-83992342

FAX: +86-24-83992102

---

### • GIGABYTE TECHNOLOGY (INDIA) LIMITED - India

WEB address : <http://www.gigabyte.in>

---

### • Saudi Arabia

WEB address : <http://www.gigabyte.com.sa>

---

### • Gigabyte Technology Pty. Ltd. - Australia

WEB address : <http://www.gigabyte.com.au>

---

### • G.B.T. TECHNOLOGY TRADING GMBH - Germany

WEB address : <http://www.gigabyte.de>

---

### • G.B.T. TECH. CO., LTD. - U.K.

WEB address : <http://www.giga-byte.co.uk>

---

### • Giga-Byte Technology B.V. - The Netherlands

WEB address : <http://www.giga-byte.nl>

---

### • GIGABYTE TECHNOLOGY FRANCE - France

WEB address : <http://www.gigabyte.fr>

---

### • Sweden

WEB address : <http://www.gigabyte.se>

---

### • Italy

WEB address : <http://www.giga-byte.it>

---

### • Spain

WEB address : <http://www.giga-byte.es>

---

### • Greece

WEB address : <http://www.gigabyte.com.gr>

---

### • Czech Republic

WEB address : <http://www.gigabyte.cz>

---

### • Hungary

WEB address : <http://www.giga-byte.hu>

---

### • Turkey

WEB address : <http://www.gigabyte.com.tr>

---

### • Russia

WEB address : <http://www.gigabyte.ru>

---

### • Poland

WEB address : <http://www.gigabyte.pl>

---

### • Ukraine

WEB address : <http://www.gigabyte.ua>

---

### • Romania

WEB address : <http://www.gigabyte.com.ro>

---

### • Serbia

WEB address : <http://www.gigabyte.co.rs>

---

### • Kazakhstan

WEB address : <http://www.gigabyte.kz>

---

## • GIGABYTE eSupport



To submit a technical or non-technical (Sales/Marketing) question, please link to:  
<http://esupport.gigabyte.com>