

GA-X58A-UD5

LGA1366 socket motherboard for Intel® Core™ i7 processor family

User's Manual

Rev. 1001

12ME-X58AUD5-1001R

Declaration of Conformity

Manufacturer/Importer

G.B.T. Technology Trading GmbH

Bahnhofstr. 16, 22047 Hamburg, Germany

Model Number

GA-X58A-UD3

Reference

EN 50191

(reference to the specification under which conformity is declared)
in accordance with 2004/108/EC EMC Directive

(description of the apparatus, system, installation to which it refers)

EN 50911 Limits and methods of measurement of radio disturbance characteristics of industrial, scientific and medical (ISM) High Frequency equipment

EN 60913

Limits and methods of measurement of radio disturbance characteristics of broadcast receivers and associated equipment

EN 55024

Limits and methods of measurement of radio disturbance characteristics of portable electrical apparatus, personal and similar electrical apparatus

EN 50082-1

Disturbances in supply systems caused by equipment in supply systems caused by equipment in supply systems caused by electrical equipment "Voltage fluctuations" Harmonics Technology equipment—immunity characteristics—Limits and methods of measurement
Generic Immunity standard Part 1: Residential, commercial and light industry
Product Immunity standard Part 2: Industrial environment

EN 50082-2

Immunity requirements for household appliances tools and similar apparatus

EN 50915

Limits and methods of measurement of radio disturbance characteristics of fluorescent lamps and luminaires

EN 56014-2

EMC requirements for unshieldable power systems (UPS)

EN 55020

Immunity from radio interference of broadcast receivers and associated equipment

EN 50091-2

EMC requirements for unshieldable power systems (UPS)

EN 55022

Limits and methods of measurement of radio disturbance characteristics of information technology equipment
 DIN VDE 0885 Cabnet distribution systems, Equipment Part 10
 Part 11
 Part 15
For receiving and/or emission from safety and television signals



(CE conformity marking)

The manufacturer declares the conformity of above mentioned product with the actual required safety standards in accordance with C10 2006/95/EC

EN 60985

Safety requirements for mains operated electronic and related apparatus for household and similar general use
 EN 60335
Safety of household and similar electrical appliances

EN 60950

Safety for information technology equipment including electrical business equipment
 EN 50091-1
General and Safety requirements for unshieldable power systems (UPS)

Manufacturer/Importer

Signature

Date

(Stamp)

Dec. 25, 2009

Name:

Timmy Huang

Timmy Huang

DECLARATION OF CONFORMITY

Per FCC Part 2 Section 2.1077(a)



Responsible Party Name: G.B.T. INC. (U.S.A.)

Address: 17358 Railroad Street

City of Industry, CA 91748

Phone/Fax No: (818) 854-9338/ (818) 854-9339

hereby declares that the product

Product Name: Motherboard

Model Number: GA-X58A-UD3

Conforms to the following specifications:

FCC Part 15, Subpart B, Section 15.107(a) and Section 15.109

(a), Class B Digital Device

Supplementary Information:

This device complies with part 15 of the FCC Rules. Operation is subject to the following two conditions: (1) This device may not cause harmful and (2) this device must accept any interference received, including that may cause undesired operation.

Representative Person's Name: ERIC LU

Signature: Eric Lu

Date: Dec. 25, 2009

Copyright

© 2009 GIGA-BYTE TECHNOLOGY CO., LTD. All rights reserved.

The trademarks mentioned in this manual are legally registered to their respective owners.

Disclaimer

Information in this manual is protected by copyright laws and is the property of GIGABYTE.

Changes to the specifications and features in this manual may be made by GIGABYTE without prior notice. No part of this manual may be reproduced, copied, translated, transmitted, or published in any form or by any means without GIGABYTE's prior written permission.

Documentation Classifications

In order to assist in the use of this product, GIGABYTE provides the following types of documentations:

- For quick set-up of the product, read the Quick Installation Guide included with the product.
- For detailed product information, carefully read the User's Manual.
- For instructions on how to use GIGABYTE's unique features, read or download the information on/from the Support&Downloads\Motherboard\Technology Guide page on our website.

For product-related information, check on our website at:

<http://www.gigabyte.com.tw>

Identifying Your Motherboard Revision

The revision number on your motherboard looks like this: "REV: X.X." For example, "REV: 1.0" means the revision of the motherboard is 1.0. Check your motherboard revision before updating motherboard BIOS, drivers, or when looking for technical information.

Example:

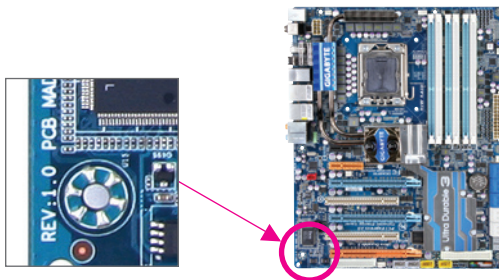

Table of Contents

Box Contents	6
Optional Items	6
GA-X58A-UD5 Motherboard Layout.....	7
Block Diagram	8
Chapter 1 Hardware Installation	9
1-1 Installation Precautions	9
1-2 Product Specifications.....	10
1-3 Installing the CPU and CPU Cooler	13
1-3-1 Installing the CPU.....	13
1-3-2 Installing the CPU Cooler	15
1-4 Installing the Memory	16
1-4-1 Dual/3 Channel Memory Configuration	16
1-4-2 Installing a Memory	17
1-5 Installing an Expansion Card	18
1-6 Setup of ATI CrossFireX™/SLI Configuration.....	19
1-7 Back Panel Connectors.....	20
1-8 Onboard LEDs and Switches	22
1-9 Internal Connectors.....	25
Chapter 2 BIOS Setup	37
2-1 Startup Screen	38
2-2 The Main Menu	39
2-3 MB Intelligent Tweaker(M.I.T.).....	41
2-4 Standard CMOS Features.....	51
2-5 Advanced BIOS Features	53
2-6 Integrated Peripherals.....	55
2-7 Power Management Setup.....	59
2-8 PC Health Status.....	61
2-9 Load Fail-Safe Defaults.....	63
2-10 Load Optimized Defaults.....	63
2-11 Set Supervisor/User Password	64
2-12 Save & Exit Setup	65
2-13 Exit Without Saving.....	65

Chapter 3 Drivers Installation.....	67
3-1 Installing Chipset Drivers	67
3-2 Application Software	68
3-3 Technical Manuals.....	68
3-4 Contact.....	69
3-5 System	69
3-6 Download Center	70
3-7 New Utilities	70
Chapter 4 Unique Features.....	71
4-1 Xpress Recovery2.....	71
4-2 BIOS Update Utilities	74
4-2-1 Updating the BIOS with the Q-Flash Utility.....	74
4-2-2 Updating the BIOS with the @BIOS Utility	77
4-3 EasyTune 6	78
4-4 Dynamic Energy Saver™ 2	79
4-5 Q-Share.....	81
4-6 Smart 6™.....	82
4-7 Auto Green.....	85
4-8 eXtreme Hard Drive (X.H.D)	86
4-9 Teaming	87
Chapter 5 Appendix.....	89
5-1 Configuring SATA Hard Drive(s).....	89
5-1-1 Configuring Intel ICH10R SATA Controllers	89
5-1-2 Configuring JMicron JMB362/GIGABYTE SATA2 SATA Controller.....	97
5-1-3 Configuring Marvell 9128 SATA Controller	103
5-1-4 Making a SATA RAID/AHCI Driver Diskette.....	108
5-1-5 Installing the SATA RAID/AHCI Driver and Operating System	110
5-2 Configuring Audio Input and Output.....	123
5-2-1 Configuring 2/4/5.1/7.1-Channel Audio.....	123
5-2-2 Configuring S/PDIF In/Out.....	125
5-2-3 Enabling the Dolby Home Theater Function	127
5-2-4 Configuring Microphone Recording	128
5-2-5 Using the Sound Recorder	130
5-3 Troubleshooting.....	131
5-3-1 Frequently Asked Questions	131
5-3-2 Troubleshooting Procedure	132
5-4 POST Error Code.....	134
5-5 Regulatory Statements.....	138

Box Contents

- GA-X58A-UD5 motherboard
- Motherboard driver disk
- User's Manual
- Quick Installation Guide
- One IDE cable
- Four SATA 3Gb/s cables
- I/O Shield
- 2-Way SLI bridge connector
- 3-Way SLI bridge connector

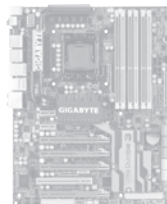

- The box contents above are for reference only and the actual items shall depend on the product package you obtain. The box contents are subject to change without notice.
- The motherboard image is for reference only.

Optional Items

- Floppy disk drive cable (Part No. 12CF1-1FD001-7*R)
- 2-port USB 2.0 bracket (Part No. 12CR1-1UB030-5*R)
- 2-port IEEE 1394a bracket (Part No. 12CF1-1IE008-0*R)
- 2-port SATA power cable (Part No. 12CF1-2SERPW-0*R)
- S/PDIF In cable (Part No. 12CR1-1SPDIN-0*R)

GA-X58A-UD5 Motherboard Layout

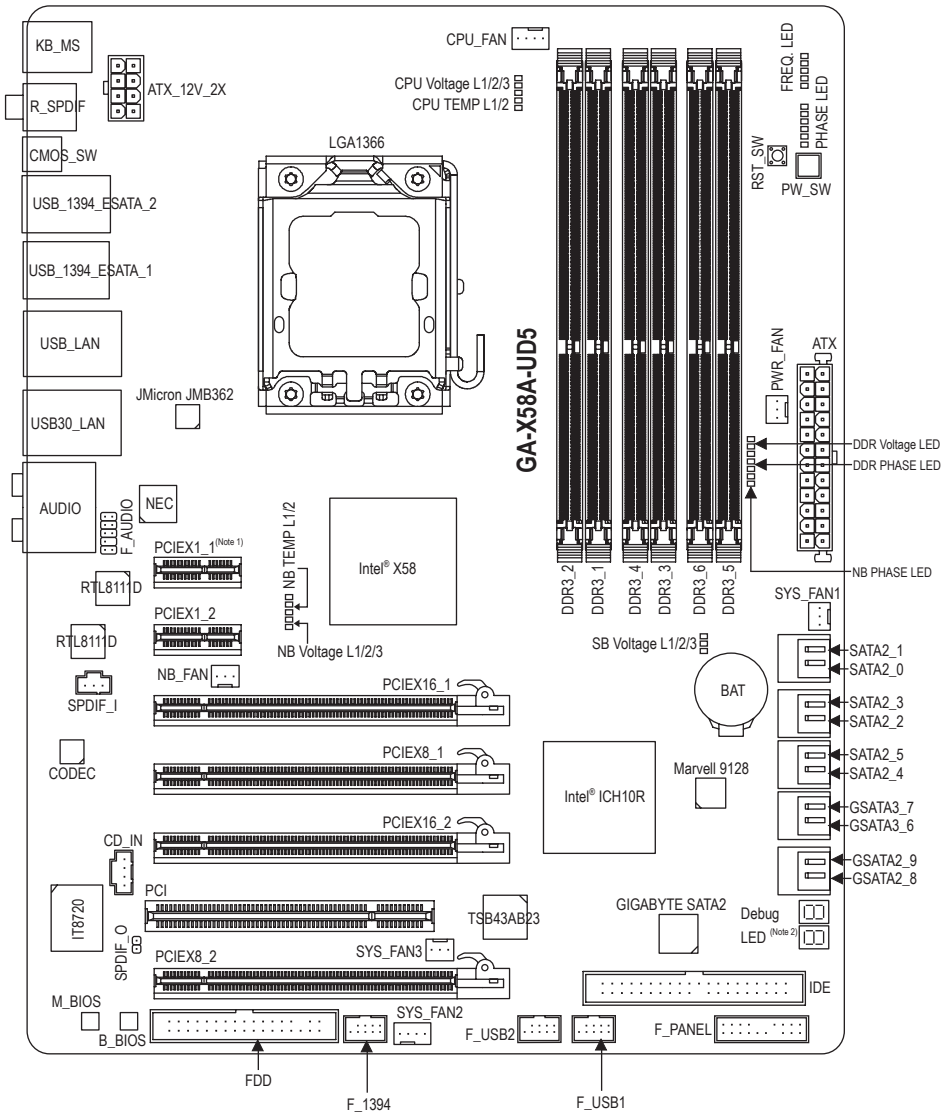

(Note 1) Due to a hardware limitation, the PCIEX1_1 slot can only accommodate a shorter PCI Express x1 expansion card. For a longer expansion card, use other expansion slots.

(Note 2) For error code information, please refer to Chapter 5.

Block Diagram

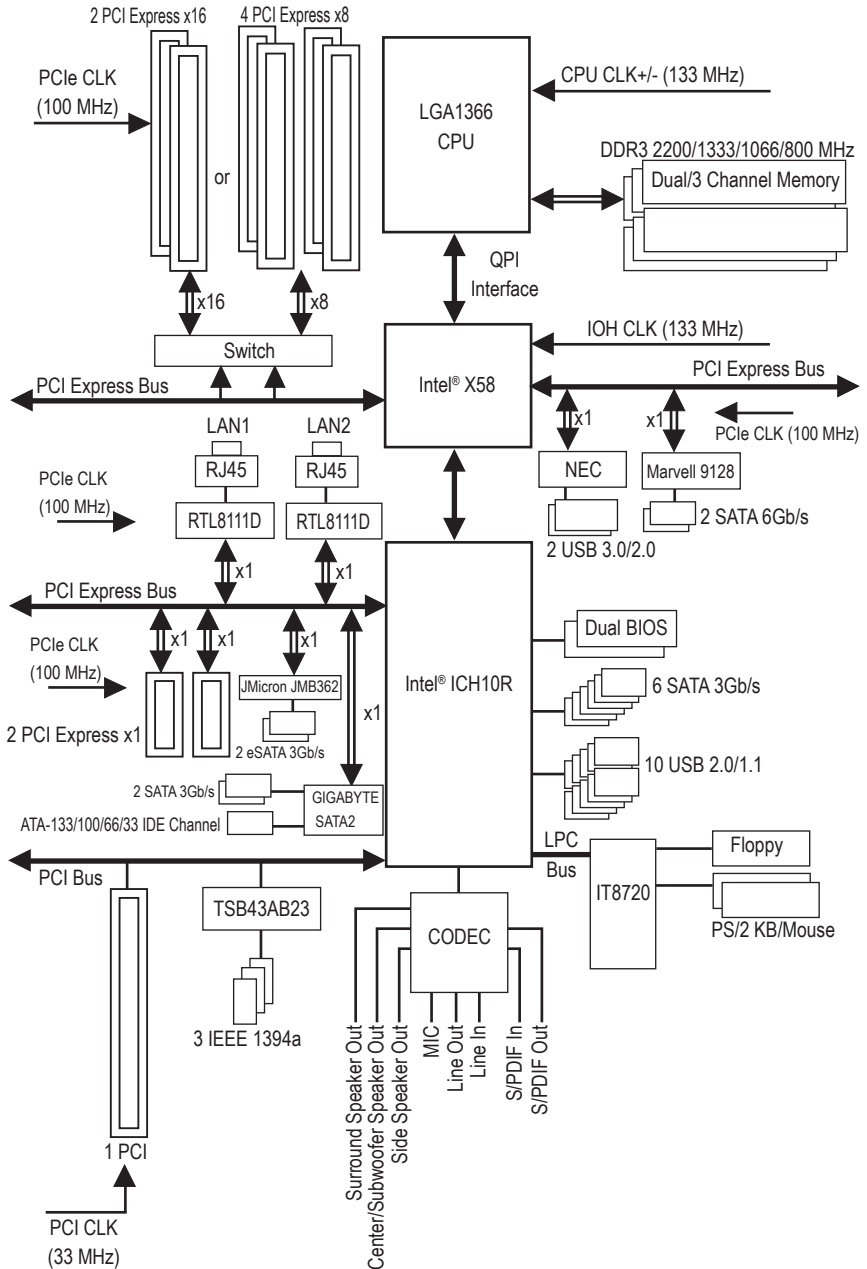









Chapter 1 Hardware Installation







1-1 Installation Precautions







The motherboard contains numerous delicate electronic circuits and components which can become damaged as a result of electrostatic discharge (ESD). Prior to installation, carefully read the user's manual and follow these procedures:

- Prior to installation, do not remove or break motherboard S/N (Serial Number) sticker or warranty sticker provided by your dealer. These stickers are required for warranty validation.
- Always remove the AC power by unplugging the power cord from the power outlet before installing or removing the motherboard or other hardware components.
- When connecting hardware components to the internal connectors on the motherboard, make sure they are connected tightly and securely.
- When handling the motherboard, avoid touching any metal leads or connectors.
- It is best to wear an electrostatic discharge (ESD) wrist strap when handling electronic components such as a motherboard, CPU or memory. If you do not have an ESD wrist strap, keep your hands dry and first touch a metal object to eliminate static electricity.
- Prior to installing the motherboard, please have it on top of an antistatic pad or within an electrostatic shielding container.
- Before unplugging the power supply cable from the motherboard, make sure the power supply has been turned off.
- Before turning on the power, make sure the power supply voltage has been set according to the local voltage standard.
- Before using the product, please verify that all cables and power connectors of your hardware components are connected.
- To prevent damage to the motherboard, do not allow screws to come in contact with the motherboard circuit or its components.
- Make sure there are no leftover screws or metal components placed on the motherboard or within the computer casing.
- Do not place the computer system on an uneven surface.
- Do not place the computer system in a high-temperature environment.
- Turning on the computer power during the installation process can lead to damage to system components as well as physical harm to the user.
- If you are uncertain about any installation steps or have a problem related to the use of the product, please consult a certified computer technician.

1-2 Product Specifications

	CPU	<ul style="list-style-type: none"> ◆ Support for an Intel® Core™ i7 series processor in the LGA1366 package (Go to GIGABYTE's website for the latest CPU support list.) ◆ L3 cache varies with CPU
	QPI	<ul style="list-style-type: none"> ◆ 4.8GT/s, 6.4GT/s
	Chipset	<ul style="list-style-type: none"> ◆ North Bridge: Intel® X58 Express Chipset ◆ South Bridge: Intel® ICH10R
	Memory	<ul style="list-style-type: none"> ◆ 6 x 1.5V DDR3 DIMM sockets supporting up to 24 GB of system memory^(Note 1) ◆ Dual/3 channel memory architecture ◆ Support for DDR3 2200/1333/1066/800 MHz memory modules ◆ Support for non-ECC memory modules ◆ Support for Extreme Memory Profile (XMP) memory modules (Go to GIGABYTE's website for the latest memory support list.)
	Audio	<ul style="list-style-type: none"> ◆ Realtek ALC889 codec ◆ High Definition Audio ◆ 2/4/5.1/7.1-channel ◆ Support for Dolby® Home Theater ◆ Support for S/PDIF In/Out ◆ Support for CD In
	LAN	<ul style="list-style-type: none"> ◆ 2 x RTL8111D chip (10/100/1000 Mbit) ◆ Support for Teaming ◆ Support Smart Dual LAN
	Expansion Slots	<ul style="list-style-type: none"> ◆ 2 x PCI Express x16 slots, running at x16 (PCIEX16_1/PCIEX16_2)^(Note 2) ◆ 2 x PCI Express x16 slot, running at x8 (PCIEX8_1/PCIEX8_2)^(Note 3) (The PCIEX16_1, PCIEX16_2, PCIEX8_1 and PCIEX8_2 slots conform to PCI Express 2.0 standard.) ◆ 2 x PCI Express x1 slots ◆ 1 x PCI slot
	Multi-Graphics Technology	<ul style="list-style-type: none"> ◆ Support for 2-Way/3-Way ATI CrossFireX™/NVIDIA SLI technology
	Storage Interface	<ul style="list-style-type: none"> ◆ South Bridge: <ul style="list-style-type: none"> - 6 x SATA 3Gb/s connectors (SATA2_0, SATA2_1, SATA2_2, SATA2_3, SATA2_4, SATA2_5) supporting up to 6 SATA 3Gb/s devices - Support for SATA RAID 0, RAID 1, RAID 5, and RAID 10 ◆ Marvell 9128 chip: <ul style="list-style-type: none"> - 2 x SATA 6Gb/s connectors (GSATA3_6, GSATA3_7) supporting up to 2 SATA 6Gb/s devices - Support for SATA RAID 0, and RAID 1 ◆ GIGABYTE SATA2 chip: <ul style="list-style-type: none"> - 1 x IDE connector supporting ATA-133/100/66/33 and up to 2 IDE devices - 2 x SATA 3Gb/s connectors (GSATA2_8, GSATA2_9) supporting up to 2 SATA 3Gb/s devices - Support for SATA RAID 0, RAID 1, and JBOD

	Storage Interface <ul style="list-style-type: none"> ◆ JMicron JMB362 chip: <ul style="list-style-type: none"> - 2 x eSATA 3Gb/s connectors (eSATA/USB Combo) on the back panel supporting up to 2 SATA 3Gb/s devices - Support for SATA RAID 0, RAID 1, and JBOD ◆ iTE IT8720 chip: <ul style="list-style-type: none"> - 1 x floppy disk drive connector supporting up to 1 floppy disk drive
	USB <ul style="list-style-type: none"> ◆ Integrated in the South Bridge <ul style="list-style-type: none"> - Up to 10 USB 2.0/1.1 ports (6 on the back panel, including 2 eSATA/USB Combo, 4 via the USB brackets connected to the internal USB headers) ◆ NEC chip: <ul style="list-style-type: none"> - Up to 2 USB 3.0/2.0 ports on the back panel
	IEEE 1394 <ul style="list-style-type: none"> ◆ T.I. TSB43AB23 chip <ul style="list-style-type: none"> - Up to 3 IEEE 1394a ports (2 on the back panel, 1 via the IEEE 1394a bracket connected to the internal IEEE 1394a header)
	Internal Connectors <ul style="list-style-type: none"> ◆ 1 x 24-pin ATX main power connector ◆ 1 x 8-pin ATX 12V power connector ◆ 1 x floppy disk drive connector ◆ 1 x IDE connector ◆ 8 x SATA 3Gb/s connectors ◆ 2 x SATA 6Gb/s connectors ◆ 1 x CPU fan header ◆ 3 x system fan headers ◆ 1 x power fan header ◆ 1 x North Bridge fan header ◆ 1 x front panel header ◆ 1 x front panel audio header ◆ 1 x CD In connector ◆ 1 x S/PDIF In header ◆ 1 x S/PDIF Out header ◆ 2 x USB 2.0/1.1 headers ◆ 1 x IEEE 1394a header ◆ 1 x power button ◆ 1 x reset button
	Back Panel Connectors <ul style="list-style-type: none"> ◆ 1 x PS/2 keyboard port ◆ 1 x PS/2 mouse port ◆ 1 x coaxial S/PDIF Out connector ◆ 1 x optical S/PDIF Out connector ◆ 1 x clearing CMOS button ◆ 2 x IEEE 1394a ports ◆ 4 x USB 2.0/1.1 ports ◆ 2 x USB 3.0 ports ◆ 2 x eSATA/USB Combo connectors ◆ 2 x RJ-45 port ◆ 6 x audio jacks (Center/Subwoofer Speaker Out/Rear Speaker Out/Side Speaker Out/Line In/Line Out/Microphone)
	I/O Controller <ul style="list-style-type: none"> ◆ iTE IT8720 chip

 Hardware Monitor	<ul style="list-style-type: none"> ◆ System voltage detection ◆ CPU/North Bridge temperature detection ◆ CPU/System/Power fan speed detection ◆ CPU overheating warning ◆ CPU fan fail warning ◆ CPU/System fan speed control ^(Note 4)
 BIOS	<ul style="list-style-type: none"> ◆ 2 x 16 Mbit flash ◆ Use of licensed AWARD BIOS ◆ Support for DualBIOS™ ◆ PnP 1.0a, DMI 2.0, SM BIOS 2.4, ACPI 1.0b
 Unique Features	<ul style="list-style-type: none"> ◆ Support for @BIOS ◆ Support for Q-Flash ◆ Support for Xpress BIOS Rescue ◆ Support for Download Center ◆ Support for Xpress Install ◆ Support for Xpress Recovery2 ◆ Support for EasyTune ^(Note 5) ◆ Support for Dynamic Energy Saver™ 2 ◆ Support for Smart 6™ ◆ Support for Auto Green ◆ Support for eXtreme Hard Drive ◆ Support for Q-Share
 Bundled Software	<ul style="list-style-type: none"> ◆ Norton Internet Security (OEM version)
 Operating System	<ul style="list-style-type: none"> ◆ Support for Microsoft® Windows® 7/Vista/XP
 Form Factor	<ul style="list-style-type: none"> ◆ ATX Form Factor; 30.5cm x 24.4cm

(Note 1) Due to Windows 32-bit operating system limitation, when more than 4 GB of physical memory is installed, the actual memory size displayed will be less than 4 GB.

(Note 2) For optimum performance, if only one PCI Express graphics card is to be installed, be sure to install it in the PCIEX16_1 slot; if you are installing two PCI Express graphics cards, it is recommended that you install them in the PCIEX16_1 and PCIEX16_2 slots.

(Note 3) The PCIEX8_1 and PCIEX8_2 slots share bandwidth with the PCIEX16_1 and PCIEX16_2 slots respectively. When PCIEX8_1 is populated with an expansion card, the PCIEX16_1 slot will operate at up to x8 mode; when PCIEX8_2 is populated with an expansion card, the PCIEX16_2 slot will operate at up to x8 mode.

(Note 4) Whether the CPU/system fan speed control function is supported will depend on the CPU/system cooler you install.

(Note 5) Available functions in EasyTune may differ by motherboard model.

1-3 Installing the CPU and CPU Cooler



Read the following guidelines before you begin to install the CPU:

- Make sure that the motherboard supports the CPU.
(Go to GIGABYTE's website for the latest CPU support list.)
- Always turn off the computer and unplug the power cord from the power outlet before installing the CPU to prevent hardware damage.
- Locate the pin one of the CPU. The CPU cannot be inserted if oriented incorrectly. (Or you may locate the notches on both sides of the CPU and alignment keys on the CPU socket.)
- Apply an even and thin layer of thermal grease on the surface of the CPU.
- Do not turn on the computer if the CPU cooler is not installed, otherwise overheating and damage of the CPU may occur.
- Set the CPU host frequency in accordance with the CPU specifications. It is not recommended that the system bus frequency be set beyond hardware specifications since it does not meet the standard requirements for the peripherals. If you wish to set the frequency beyond the standard specifications, please do so according to your hardware specifications including the CPU, graphics card, memory, hard drive, etc.

1-3-1 Installing the CPU

A. Locate the alignment keys on the motherboard CPU socket and the notches on the CPU.

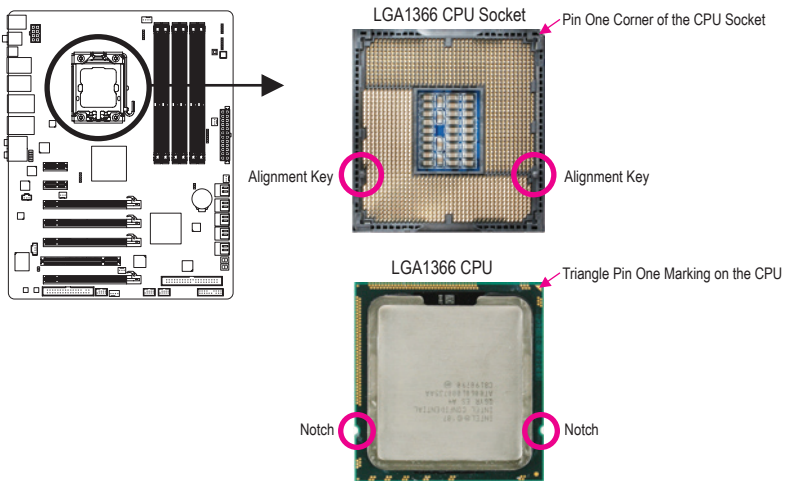

B. Follow the steps below to correctly install the CPU into the motherboard CPU socket.



Before installing the CPU, make sure to turn off the computer and unplug the power cord from the power outlet to prevent damage to the CPU.

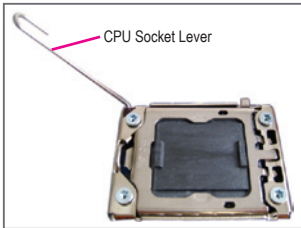

Step 1:
Completely raise the CPU socket lever.

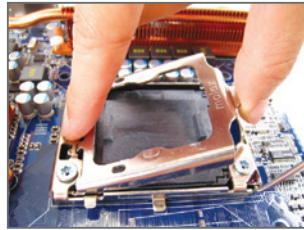

Step 2:
Lift the metal load plate from the CPU socket.

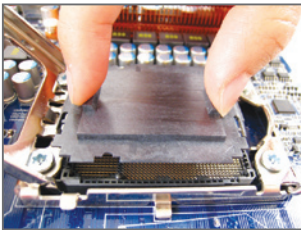

Step 3:
Use your thumb and index finger to hold the protective socket cover as indicated and lift it up vertically. (DO NOT touch socket contacts. To protect the CPU socket, always replace the protective socket cover when the CPU is not installed.)

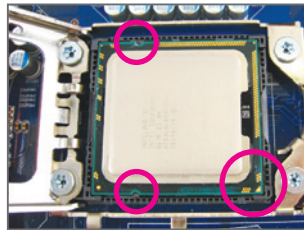

Step 4:
Hold the CPU with your thumb and index fingers. Align the CPU pin one marking (triangle) with the pin one corner of the CPU socket (or you may align the CPU notches with the socket alignment keys) and gently insert the CPU into position.



Step 5:
Once the CPU is properly inserted, replace the load plate and push the CPU socket lever back into its locked position.

1-3-2 Installing the CPU Cooler

Follow the steps below to correctly install the CPU cooler on the motherboard. (The following procedure uses Intel® boxed cooler as the example cooler.)



Step 1:

Apply an even and thin layer of thermal grease on the surface of the installed CPU.

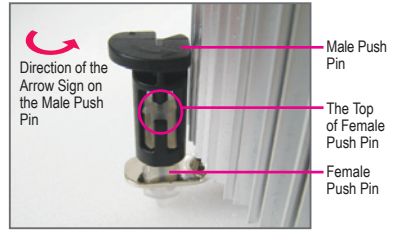

Step 2:

Before installing the cooler, note the direction of the arrow sign ↻ on the male push pin. (Turning the push pin along the direction of arrow is to remove the cooler, on the contrary, is to install.)

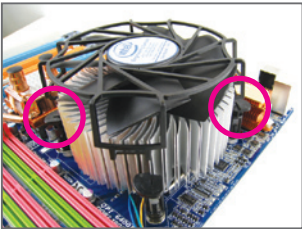

Step 3:

Place the cooler atop the CPU, aligning the four push pins through the pin holes on the motherboard. Push down on the push pins diagonally.



Step 4:

You should hear a "click" when pushing down each push pin. Check that the Male and Female push pins are joined closely. (Refer to your CPU cooler installation manual for instructions on installing the cooler.)

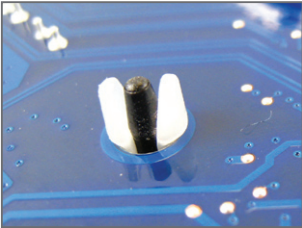

Step 5:

After the installation, check the back of the motherboard. If the push pin is inserted as the picture above shows, the installation is complete.

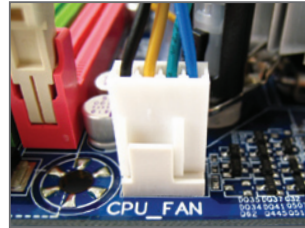

Step 6:

Finally, attach the power connector of the CPU cooler to the CPU fan header (CPU_FAN) on the motherboard.



Use extreme care when removing the CPU cooler because the thermal grease/tape between the CPU cooler and CPU may adhere to the CPU. Inadequately removing the CPU cooler may damage the CPU.

1-4 Installing the Memory



Read the following guidelines before you begin to install the memory:

- Make sure that the motherboard supports the memory. It is recommended that memory of the same capacity, brand, speed, and chips be used.
(Go to GIGABYTE's website for the latest memory support list.)
- Always turn off the computer and unplug the power cord from the power outlet before installing the memory to prevent hardware damage.
- Memory modules have a foolproof design. A memory module can be installed in only one direction. If you are unable to insert the memory, switch the direction.

1-4-1 Dual/3 Channel Memory Configuration



This motherboard provides six DDR3 memory sockets and supports Dual/3 Channel Technology. After the memory is installed, the BIOS will automatically detect the specifications and capacity of the memory. Dual or 3 Channel memory mode may double or triple the original memory bandwidth.

The six DDR3 memory sockets are divided into three channels:

- ▶▶ Channel 0: DDR3_1, DDR3_2
- ▶▶ Channel 1: DDR3_3, DDR3_4
- ▶▶ Channel 2: DDR3_5, DDR3_6

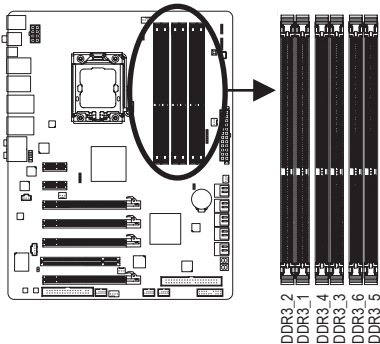

▶▶ Dual Channel Memory Configurations Table

	DDR3_2	DDR3_1	DDR3_4	DDR3_3	DDR3_6	DDR3_5
Two Modules	--	DS/SS	--	DS/SS	--	--
Four Modules	DS/SS	DS/SS	DS/SS	DS/SS	--	--

▶▶ 3 Channel Memory Configurations Table

	DDR3_2	DDR3_1	DDR3_4	DDR3_3	DDR3_6	DDR3_5
Three Modules	--	DS/SS	--	DS/SS	--	DS/SS
Four Modules	DS/SS	DS/SS	--	DS/SS	--	DS/SS
Six Modules	DS/SS	DS/SS	DS/SS	DS/SS	DS/SS	DS/SS

(SS=Single-Sided, DS=Double-Sided, "--"=No Memory)

Due to chipset limitation, read the following guidelines before installing the memory in Dual or 3 Channel mode.

Dual Channel--

1. Dual Channel mode cannot be enabled if only one DDR3 memory module is installed.
2. When enabling Dual Channel mode with two or four modules, it is recommended that memory of the same capacity, brand, speed, and chips be used. When enabling Dual Channel mode with two memory modules, be sure to install them in the DDR3_1 and DDR3_3 sockets.

3 Channel--

1. 3 Channel mode cannot be enabled if only one or two DDR3 memory modules are installed.
2. When enabling 3 Channel mode with three, four or six modules, it is recommended that memory of the same capacity, brand, speed, and chips be used. When enabling 3 Channel mode with three memory modules, be sure to install them in the DDR3_1, DDR3_3 and DDR3_5 sockets. When enabling 3 Channel mode with four memory modules, be sure to install them in the DDR3_1, DDR3_2, DDR3_3 and DDR3_5 sockets.



- If only one DDR3 memory module is installed, be sure to install it in the DDR3_1 or DDR3_3.
- When memory modules of different capacity and chips are installed, a message which says memory is operating in Flex Memory Mode will appear during the POST. Intel® Flex Memory Technology offers greater flexibility to upgrade by allowing different memory sizes to be populated and remain in Dual/3 Channel mode/performance.

1-4-2 Installing a Memory



Before installing a memory module, make sure to turn off the computer and unplug the power cord from the power outlet to prevent damage to the memory module.

DDR3 and DDR2 DIMMs are not compatible to each other or DDR DIMMs. Be sure to install DDR3 DIMMs on this motherboard.

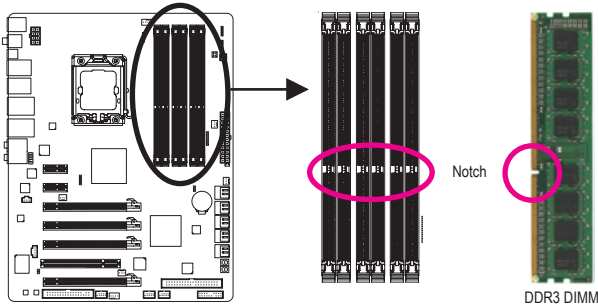

A DDR3 memory module has a notch, so it can only fit in one direction. Follow the steps below to correctly install your memory modules in the memory sockets.

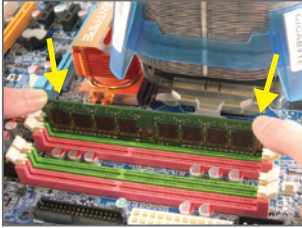

Step 1:

Note the orientation of the memory module. Spread the retaining clips at both ends of the memory socket. Place the memory module on the socket. As indicated in the picture on the left, place your fingers on the top edge of the memory, push down on the memory and insert it vertically into the memory socket.

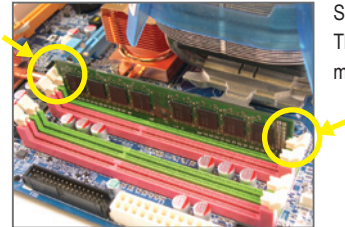

Step 2:

The clips at both ends of the socket will snap into place when the memory module is securely inserted.

1-5 Installing an Expansion Card



Read the following guidelines before you begin to install an expansion card:

- Make sure the motherboard supports the expansion card. Carefully read the manual that came with your expansion card.
- Always turn off the computer and unplug the power cord from the power outlet before installing an expansion card to prevent hardware damage.

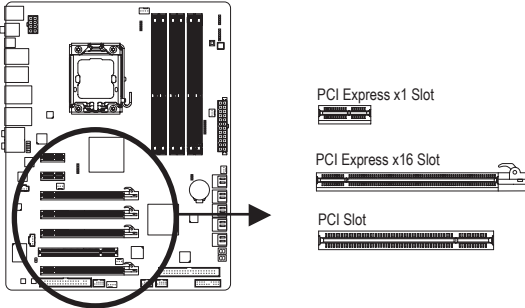

Follow the steps below to correctly install your expansion card in the expansion slot.

1. Locate an expansion slot that supports your card. Remove the metal slot cover from the chassis back panel.
2. Align the card with the slot, and press down on the card until it is fully seated in the slot.
3. Make sure the metal contacts on the card are completely inserted into the slot.
4. Secure the card's metal bracket to the chassis back panel with a screw.
5. After installing all expansion cards, replace the chassis cover(s).
6. Turn on your computer. If necessary, go to BIOS Setup to make any required BIOS changes for your expansion card(s).
7. Install the driver provided with the expansion card in your operating system.

Example: Installing and Removing a PCI Express Graphics Card:



- **Installing a Graphics Card:**
Gently push down on the top edge of the card until it is fully inserted into the PCI Express slot. Make sure the card is securely seated in the slot and does not rock.



- **Removing the Card:**
Press the white latch at the end of the PCI Express slot to release the card and then pull the card straight up from the slot.

1-6 Setup of ATI CrossFire™/SLI Configuration

A. System Requirements

- The 2-Way CrossFireX/SLI technology currently supports Windows XP, Windows Vista, and Windows 7 operating systems
- The 3-Way CrossFireX/SLI technology currently supports Windows Vista and Windows 7 operating systems only
- A CrossFireX/SLI-supported motherboard with two/three PCI Express x16 slots and correct driver
- Two/three CrossFireX/SLI-ready graphics cards of identical brand and chip and correct driver (Current ATI GPUs that support 3-Way CrossFireX technology include the Radeon HD 3800 series, Radeon HD 4800 and Radeon HD 58XX series. Current NVIDIA GPUs that support 3-Way SLI technology include the 8800 GTX, 8800 Ultra, 9800 GTX, GTX 260 and GTX 280.)
- One/two CrossFire^(Note)/SLI bridge connectors
- A power supply with sufficient power is recommended (Refer to the manual of your graphics cards for the power requirement)

B. Connecting the Graphics Cards

Step 1:

Observe the steps in "1-5 Installing an Expansion Card" and install two/three CrossFireX/SLI graphics cards on the PCI Express x16 slots. (To set up a 2-Way configuration, we recommend installing the graphics cards on the PCIEX16_1 and PCIEX16_2 slots.)

Step 2:

Insert the CrossFire^(Note)/SLI bridge connector(s) in the CrossFireX/SLI gold edge connectors on top of the two/three cards.

Step 3:

Plug the display cable into the graphics card on the PCIEX16_1 slot.

C. Configuring the Graphics Card Driver

C-1. To Enable CrossFireX Function

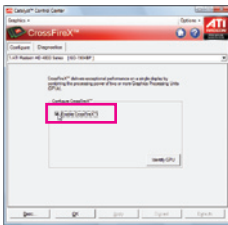

For 2-Way CrossFireX:
After installing the graphics card driver in the operating system, go to the **Catalyst Control Center**. Browse to the **CrossFireX** menu and select the **Enable CrossFireX™** check box. Click **OK** to apply.

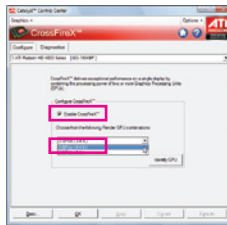

For 3-Way CrossFireX:
After installing the graphics card driver in the operating system, go to the **Catalyst Control Center**. Browse to the **CrossFireX** menu, select the **Enable CrossFireX™** check box, and select the **3 GPUs** combination. Click **OK** to apply.

C-2. To Enable SLI Function

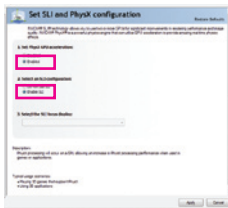

For 2-Way/3-Way SLI:
After installing the graphics card driver in the operating system, go to the **NVIDIA Control Panel**. Browse to the **Set SLI and Physx Configuration** screen and ensure the **SLI configuration** and **Physx** is enabled.

(Note) The bridge connectors may be needed or not depending on your graphics cards.



Procedure and driver screen for enabling CrossFireX/SLI technology may differ by graphics cards. Refer to the manual that came with your graphics cards for more information about enabling CrossFireX technology.

1-7 Back Panel Connectors

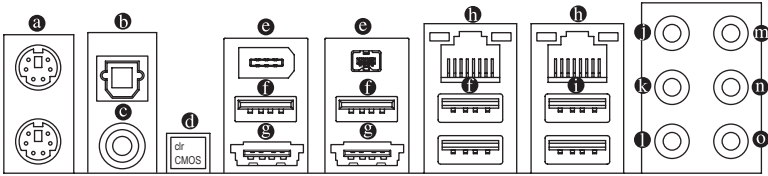

a PS/2 Keyboard and PS/2 Mouse Port

Use the upper port (green) to connect a PS/2 mouse and the lower port (purple) to connect a PS/2 keyboard.

b Optical S/PDIF Out Connector

This connector provides digital audio out to an external audio system that supports digital optical audio. Before using this feature, ensure that your audio system provides an optical digital audio in connector.

c Coaxial S/PDIF Out Connector

This connector provides digital audio out to an external audio system that supports digital coaxial audio. Before using this feature, ensure that your audio system provides a coaxial digital audio in connector.

d Clearing CMOS Button

Press the clearing CMOS switch to clear CMOS values.

e IEEE 1394a Port

The IEEE 1394 port supports the IEEE 1394a specification, featuring high speed, high bandwidth and hotplug capabilities. Use this port for an IEEE 1394a device.

f USB 2.0/1.1 Port

The USB port supports the USB 2.0/1.1 specification. Use this port for USB devices such as a USB keyboard/mouse, USB printer, USB flash drive and etc.

g eSATA/USB Combo Connector

This connector supports SATA 3Gb/s and USB 2.0/1.1 specification. Use the port to connect an external SATA device or a SATA port multiplier; or use this port for USB devices such as a USB keyboard/mouse, USB printer, USB flash drive and etc.

h RJ-45 LAN Port

The Gigabit Ethernet LAN port provides Internet connection at up to 1 Gbps data rate. The following describes the states of the LAN port LEDs.

Connection/
Speed LED

Activity LED



LAN Port

Connection/Speed LED:

State	Description
Orange	1 Gbps data rate
Green	100 Mbps data rate
Off	10 Mbps data rate

Activity LED:

State	Description
Blinking	Data transmission or receiving is occurring
Off	No data transmission or receiving is occurring



- When removing the cable connected to a back panel connector, first remove the cable from your device and then remove it from the motherboard.
- When removing the cable, pull it straight out from the connector. Do not rock it side to side to prevent an electrical short inside the cable connector.

① **USB 3.0/2.0 Port**

The USB 3.0 port supports the USB 3.0 specification and is compatible to the USB 2.0/1.1 specification. Use this port for USB devices such as a USB keyboard/mouse, USB printer, USB flash drive and etc.

② **Center/Subwoofer Speaker Out Jack (Orange)**

Use this audio jack to connect center/subwoofer speakers in a 5.1/7.1-channel audio configuration.

③ **Rear Speaker Out Jack (Black)**

Use this audio jack to connect rear speakers in a 7.1-channel audio configuration.

④ **Side Speaker Out Jack (Gray)**

Use this audio jack to connect side speakers in a 4/5.1/7.1-channel audio configuration.

⑤ **Line In Jack (Blue)**

The default line in jack. Use this audio jack for line in devices such as an optical drive, walkman, etc.

⑥ **Line Out Jack (Green)**

The default line out jack. Use this audio jack for a headphone or 2-channel speaker. This jack can be used to connect front speakers in a 4/5.1/7.1-channel audio configuration.

⑦ **Mic In Jack (Pink)**

The default Mic in jack. Microphones must be connected to this jack.



In addition to the default speakers settings, the ② ~ ④ audio jacks can be reconfigured to perform different functions via the audio software. Only microphones still **MUST** be connected to the default Mic in jack (⑦). Refer to the instructions on setting up a 2/4/5.1/7.1-channel audio configuration in Chapter 5, "Configuring 2/4/5.1/7.1-Channel Audio."

1-8 Onboard LEDs and Switches

Overvoltage LEDs

This motherboard contains 4 sets of overvoltage LEDs which indicate the overvoltage level of the CPU, memory, North Bridge, and South Bridge.

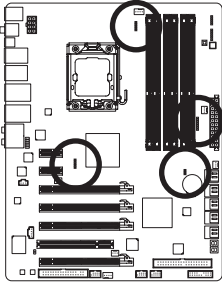

CPU Voltage

- Off: Normal condition
- L1: Level 1 (Slight, green)
- L2: Level 2 (Moderate, yellow)
- L3: Level 3 (High, red)

DDR Voltage

- Off: Normal condition
- L1: Level 1 (Slight, green)
- L2: Level 2 (Moderate, yellow)
- L3: Level 3 (High, red)

NB Voltage

- Off: Normal condition
- L1: Level 1 (Slight, green)
- L2: Level 2 (Moderate, yellow)
- L3: Level 3 (High, red)

SB Voltage

- Off: Normal condition
- L1: Level 1 (Slight, green)
- L2: Level 2 (Moderate, yellow)
- L3: Level 3 (High, red)

Overclock LEDs

The onboard CPU overclock LEDs indicate on which level the CPU is overclocked. The higher the overclock level, the more the number of lighted LEDs.

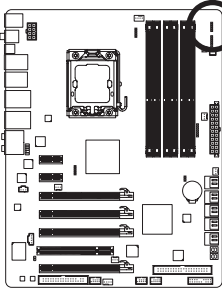

FREQ. LED

- Off: Normal condition
- F_LED1~F_LED5: Blue

Temperature Indicator LEDs

The two sets of temperature indicator LEDs indicate the temperature level of the CPU and North Bridge. The LEDs are off when the temperature is below 60°C; the green LED lights up when the temperature is between 61~80°C; the red LED is illuminated when the temperature exceeds 80°C.

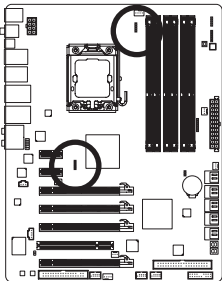

CPU TEMP

- Off: Below 60°C
- L1: 61~ 80°C (green)
- L2: Over 80°C (red)

NB TEMP

- Off: Below 60°C
- L1: 61~ 80°C (green)
- L2: Over 80°C (red)

Quick Switches

This motherboard has 2 quick buttons: power button and reset button. The power button and reset button allow users to quickly turn on/off or reset the computer in an open-case environment when they want to change hardware components or conduct hardware testing.

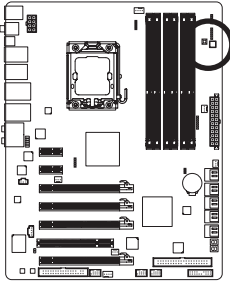

PW_SW: Power switch

RST_SW: Reset switch

PHASE LED

The number of lighted LEDs indicates the CPU loading. The higher the CPU loading, the more the number of lighted LEDs. To enable the Phase LED display function, please first enable Dynamic Energy Saver 2. Refer to Chapter 4, "Dynamic Energy Saver 2," for more details.

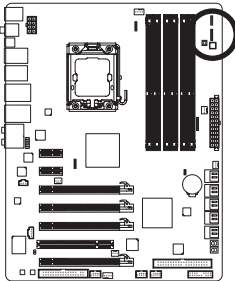

NB PHASE LED

The number of lighted LEDs indicates the North Bridge loading. The higher the North Bridge loading, the more the number of lighted LEDs.

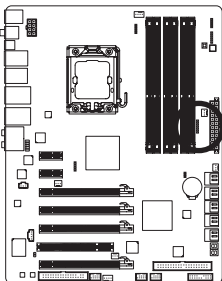

DDR PHASE LED

The number of lighted LEDs indicates the memory loading. The higher the memory loading, the more the number of lighted LEDs.

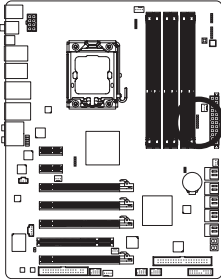

1-9 Internal Connectors

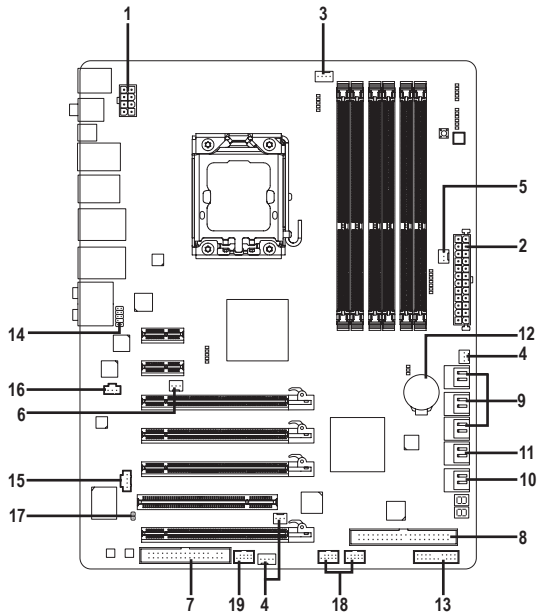

1)	ATX_12V_2X	11)	GSATA3_6/7
2)	ATX	12)	BAT
3)	CPU_FAN	13)	F_PANEL
4)	SYS_FAN1/2/3	14)	F_AUDIO
5)	PWR_FAN	15)	CD_IN
6)	NB_FAN	16)	SPDIF_I
7)	FDD	17)	SPDIF_O
8)	IDE	18)	F_USB1/F_USB2
9)	SATA2_0/1/2/3/4/5	19)	F_1394
10)	GSATA2_8/9		



Read the following guidelines before connecting external devices:

- First make sure your devices are compliant with the connectors you wish to connect.
- Before installing the devices, be sure to turn off the devices and your computer. Unplug the power cord from the power outlet to prevent damage to the devices.
- After installing the device and before turning on the computer, make sure the device cable has been securely attached to the connector on the motherboard.

1/2) ATX_12V_2X/ATX (2x4 12V Power Connector and 2x12 Main Power Connector)

With the use of the power connector, the power supply can supply enough stable power to all the components on the motherboard. Before connecting the power connector, first make sure the power supply is turned off and all devices are properly installed. The power connector possesses a foolproof design. Connect the power supply cable to the power connector in the correct orientation. The 12V power connector mainly supplies power to the CPU. If the 12V power connector is not connected, the computer will not start.



- Use of a power supply providing a 2x4 12V power connector is recommended by the CPU manufacturer when using an Intel Extreme Edition CPU (130W).
- To meet expansion requirements, it is recommended that a power supply that can withstand high power consumption be used (500W or greater). If a power supply is used that does not provide the required power, the result can lead to an unstable or unbootable system.
- The power connectors are compatible with power supplies with 2x2 12V and 2x10 power connectors. When using a power supply providing a 2x4 12V and a 2x12 power connector, remove the protective covers from the 12V power connector and the main power connector on the motherboard. Do not insert the power supply cables into pins under the protective covers when using a power supply providing a 2x2 12V and a 2x10 power connector.

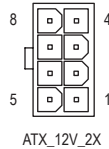
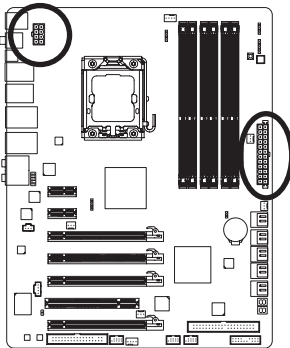

ATX_12V_2X:

Pin No.	Definition
1	GND (Only for 2x4-pin 12V)
2	GND (Only for 2x4-pin 12V)
3	GND
4	GND
5	+12V (Only for 2x4-pin 12V)
6	+12V (Only for 2x4-pin 12V)
7	+12V
8	+12V

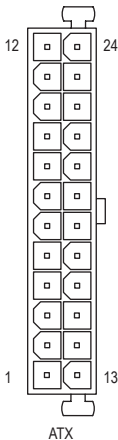

ATX:

Pin No.	Definition	Pin No.	Definition
1	3.3V	13	3.3V
2	3.3V	14	-12V
3	GND	15	GND
4	+5V	16	PS_ON (soft On/Off)
5	GND	17	GND
6	+5V	18	GND
7	GND	19	GND
8	Power Good	20	-5V
9	5VSB (stand by +5V)	21	+5V
10	+12V	22	+5V
11	+12V (Only for 2x12-pin ATX)	23	+5V (Only for 2x12-pin ATX)
12	3.3V (Only for 2x12-pin ATX)	24	GND (Only for 2x12-pin ATX)

3/4/5) CPU_FAN/SYS_FAN1/SYS_FAN2/SYS_FAN3/PWR_FAN (Fan Headers)

The motherboard has a 4-pin CPU fan header (CPU_FAN), a 4-pin (SYS_FAN2) and two 3-pin (SYS_FAN1/SYS_FAN3) system fan headers, and a 3-pin power fan header (PWR_FAN). Most fan headers possess a foolproof insertion design. When connecting a fan cable, be sure to connect it in the correct orientation (the black connector wire is the ground wire). The motherboard supports CPU fan speed control, which requires the use of a CPU fan with fan speed control design. For optimum heat dissipation, it is recommended that a system fan be installed inside the chassis.

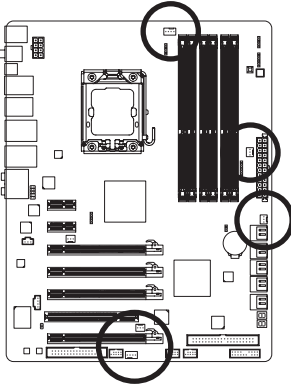

CPU_FAN



SYS_FAN2



SYS_FAN1/PWR_FAN



SYS_FAN3

CPU_FAN:

Pin No.	Definition
1	GND
2	+12V / Speed Control
3	Sense
4	Speed Control

SYS_FAN2:

Pin No.	Definition
1	GND
2	+12V / Speed Control
3	Sense
4	Reserve

SYS_FAN1/SYS_FAN3/PWR_FAN:

Pin No.	Definition
1	GND
2	+12V
3	Sense

6) NB_FAN (North Bridge Fan Header)

Connect the North Bridge fan cable to this header. The fan header has a foolproof insertion design. When connecting a fan cable, be sure to connect it in the correct orientation. Most fans are designed with color-coded power connector wires. A red power connector wire indicates a positive connection and requires a +12V voltage. The black connector wire is the ground wire.

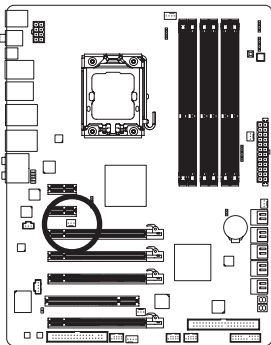

Pin No.	Definition
1	GND
2	+12V
3	NC



- Be sure to connect fan cables to the fan headers to prevent your CPU, North Bridge and system from overheating. Overheating may result in damage to the CPU/North Bridge or the system may hang.
- These fan headers are not configuration jumper blocks. Do not place a jumper cap on the headers.

7) FDD (Floppy Disk Drive Connector)

This connector is used to connect a floppy disk drive. The types of floppy disk drives supported are: 360 KB, 720 KB, 1.2 MB, 1.44 MB, and 2.88 MB. Before connecting a floppy disk drive, be sure to locate pin 1 of the connector and the floppy disk drive cable. The pin 1 of the cable is typically designated by a stripe of different color. For purchasing the optional floppy disk drive cable, please contact the local dealer.

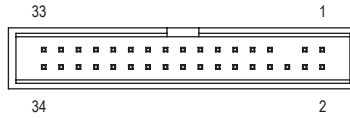
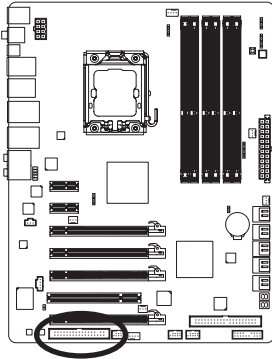

8) IDE (IDE Connector)

The IDE connector supports up to two IDE devices such as hard drives and optical drives. Before attaching the IDE cable, locate the foolproof groove on the connector. If you wish to connect two IDE devices, remember to set the jumpers and the cabling according to the role of the IDE devices (for example, master or slave). (For information about configuring master/slave settings for the IDE devices, read the instructions from the device manufacturers.)

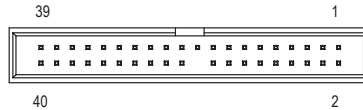
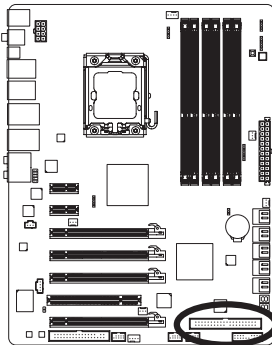

9) SATA2_0/1/2/3/4/5 (SATA 3Gb/s Connectors, Controlled by ICH10R)

The SATA connectors conform to SATA 3Gb/s standard and are compatible with SATA 1.5Gb/s standard. Each SATA connector supports a single SATA device. The ICH10R controller supports RAID 0, RAID 1, RAID 5, and RAID 10. Refer to Chapter 5, "Configuring SATA Hard Drive(s)," for instructions on configuring a RAID array.

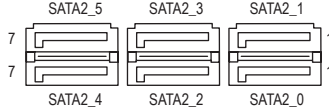
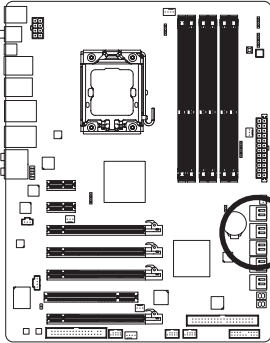

Pin No.	Definition
1	GND
2	TXP
3	TXN
4	GND
5	RXN
6	RXP
7	GND

10) GSATA2_8/9 (SATA 3Gb/s Connectors, Controlled by GIGABYTE SATA2)

The SATA connectors conform to SATA 3Gb/s standard and are compatible with SATA 1.5Gb/s standard. Each SATA connector supports a single SATA device. The GIGABYTE SATA2 controller supports RAID 0, RAID 1, and JBOD. Refer to Chapter 5, "Configuring SATA Hard Drive(s)," for instructions on configuring a RAID array.

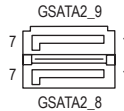
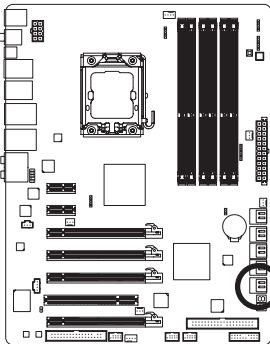

Pin No.	Definition
1	GND
2	TXP
3	TXN
4	GND
5	RXN
6	RXP
7	GND



Please connect the L-shaped end of the SATA 3Gb/s cable to your SATA hard drive.



- A RAID 0 or RAID 1 configuration requires at least two hard drives. If more than two hard drives are to be used, the total number of hard drives must be an even number.
- A RAID 5 configuration requires at least three hard drives. (The total number of hard drives does not have to be an even number.)
- A RAID 10 configuration requires at least four hard drives and the total number of hard drives must be an even number.

11) GSATA3_6/7 (SATA 6Gb/s Connectors, Controlled by Marvell 9128)

The SATA connectors conform to SATA 6Gb/s standard and are compatible with SATA 3Gb/s and SATA 1.5Gb/s standards. Each SATA connector supports a single SATA device. The Marvell 9128 supports RAID 0 and RAID 1. Refer to Chapter 5, "Configuring SATA Hard Drive(s)," for instructions on configuring a RAID array.

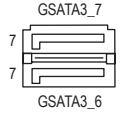
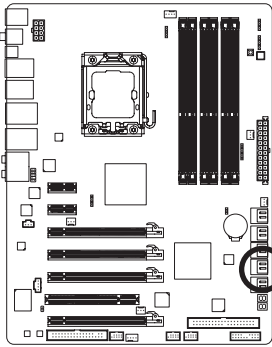

Pin No.	Definition
1	GND
2	TXP
3	TXN
4	GND
5	RXN
6	RXP
7	GND



Please connect the L-shaped end of the SATA 3Gb/s cable to your SATA hard drive.



A RAID 0 or RAID 1 configuration requires at least two hard drives. If more than two hard drives are to be used, the total number of hard drives must be an even number.

12) BAT

The battery provides power to keep the values (such as BIOS configurations, date, and time information) in the CMOS when the computer is turned off. Replace the battery when the battery voltage drops to a low level, or the CMOS values may not be accurate or may be lost.

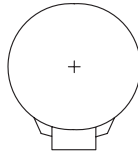
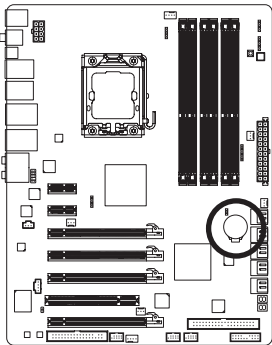

You may clear the CMOS values by removing the battery:

1. Turn off your computer and unplug the power cord.
2. Gently remove the battery from the battery holder and wait for one minute. (Or use a metal object like a screwdriver to touch the positive and negative terminals of the battery holder, making them short for 5 seconds.)
3. Replace the battery.
4. Plug in the power cord and restart your computer.



- Always turn off your computer and unplug the power cord before replacing the battery.
- Replace the battery with an equivalent one. Danger of explosion if the battery is replaced with an incorrect model.
- Contact the place of purchase or local dealer if you are not able to replace the battery by yourself or uncertain about the battery model.
- When installing the battery, note the orientation of the positive side (+) and the negative side (-) of the battery (the positive side should face up).
- Used batteries must be handled in accordance with local environmental regulations.

13) F_PANEL (Front Panel Header)

Connect the power switch, reset switch, speaker, chassis intrusion switch/sensor and system status indicator on the chassis to this header according to the pin assignments below. Note the positive and negative pins before connecting the cables.

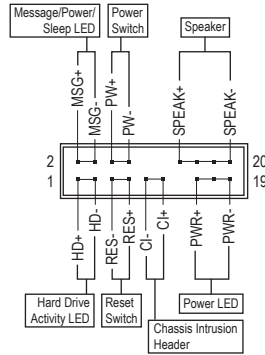
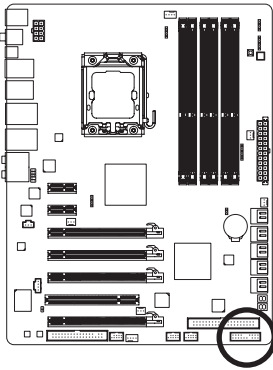

- **MSG/PWR** (Message/Power/Sleep LED, Yellow/Purple):

System Status	LED
S0	On
S1	Blinking
S3/S4/S5	Off

Connects to the power status indicator on the chassis front panel. The LED is on when the system is operating. The LED keeps blinking when the system is in S1 sleep state. The LED is off when the system is in S3/S4 sleep state or powered off (S5).

- **PW** (Power Switch, Red):

Connects to the power switch on the chassis front panel. You may configure the way to turn off your system using the power switch (refer to Chapter 2, "BIOS Setup," "Power Management Setup," for more information).

- **SPEAK** (Speaker, Orange):

Connects to the speaker on the chassis front panel. The system reports system startup status by issuing a beep code. One single short beep will be heard if no problem is detected at system startup. If a problem is detected, the BIOS may issue beeps in different patterns to indicate the problem. Refer to Chapter 5, "Troubleshooting," for information about beep codes.

- **HD** (Hard Drive Activity LED, Blue)

Connects to the hard drive activity LED on the chassis front panel. The LED is on when the hard drive is reading or writing data.

- **RES** (Reset Switch, Green):

Connects to the reset switch on the chassis front panel. Press the reset switch to restart the computer if the computer freezes and fails to perform a normal restart.

- **CI** (Chassis Intrusion Header, Gray):

Connects to the chassis intrusion switch/sensor on the chassis that can detect if the chassis cover has been removed. This function requires a chassis with a chassis intrusion switch/sensor.



The front panel design may differ by chassis. A front panel module mainly consists of power switch, reset switch, power LED, hard drive activity LED, speaker and etc. When connecting your chassis front panel module to this header, make sure the wire assignments and the pin assignments are matched correctly.

14) F_AUDIO (Front Panel Audio Header)

The front panel audio header supports Intel High Definition audio (HD) and AC'97 audio. You may connect your chassis front panel audio module to this header. Make sure the wire assignments of the module connector match the pin assignments of the motherboard header. Incorrect connection between the module connector and the motherboard header will make the device unable to work or even damage it.

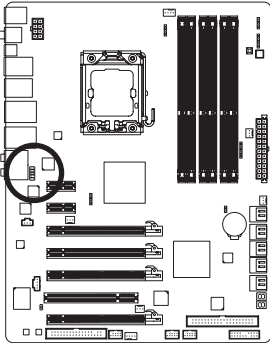

For HD Front Panel Audio:

Pin No.	Definition
1	MIC2_L
2	GND
3	MIC2_R
4	-ACZ_DET
5	LINE2_R
6	GND
7	FAUDIO_JD
8	No Pin
9	LINE2_L
10	GND

For AC'97 Front Panel Audio:

Pin No.	Definition
1	MIC
2	GND
3	MIC Power
4	NC
5	Line Out (R)
6	NC
7	NC
8	No Pin
9	Line Out (L)
10	NC



- The front panel audio header supports HD audio by default. If your chassis provides an AC'97 front panel audio module, refer to the instructions on how to activate AC'97 functionality via the audio software in Chapter 5, "Configuring 2/4/5.1/7.1-Channel Audio."
- Audio signals will be present on both of the front and back panel audio connections simultaneously. If you want to mute the back panel audio (only supported when using an HD front panel audio module), refer to Chapter 5, "Configuring 2/4/5.1/7.1-Channel Audio."
- Some chassis provide a front panel audio module that has separated connectors on each wire instead of a single plug. For information about connecting the front panel audio module that has different wire assignments, please contact the chassis manufacturer.

15) CD_IN (CD In Connector)

You can connect the audio cable that came with your optical drive to the header.

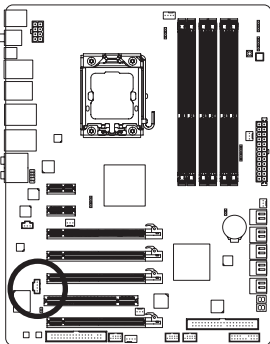

Pin No.	Definition
1	CD-L
2	GND
3	GND
4	CD-R

16) SPDIF_I (S/PDIF In Header)

This header supports digital S/PDIF In and can connect to an audio device that supports digital audio out via an optional S/PDIF In cable. For purchasing the optional S/PDIF In cable, please contact the local dealer.

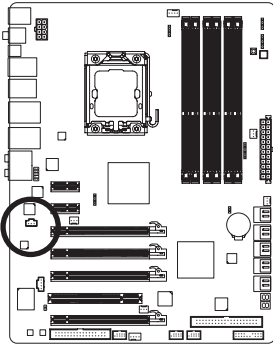

Pin No.	Definition
1	Power
2	SPDIFI
3	GND

17) SPDIF_O (S/PDIF Out Header)

This header supports digital S/PDIF Out and connects a S/PDIF digital audio cable (provided by expansion cards) for digital audio output from your motherboard to certain expansion cards like graphics cards and sound cards. For example, some graphics cards may require you to use a S/PDIF digital audio cable for digital audio output from your motherboard to your graphics card if you wish to connect an HDMI display to the graphics card and have digital audio output from the HDMI display at the same time. For information about connecting the S/PDIF digital audio cable, carefully read the manual for your expansion card.

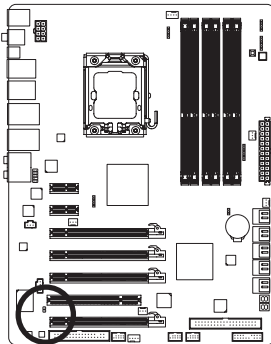

Pin No.	Definition
1	SPDIFO
2	GND

18) F_USB1/F_USB2 (USB Headers)

The headers conform to USB 2.0/1.1 specification. Each USB header can provide two USB ports via an optional USB bracket. For purchasing the optional USB bracket, please contact the local dealer.

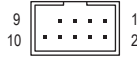
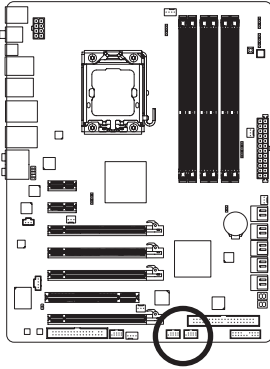

Pin No.	Definition
1	Power (5V)
2	Power (5V)
3	USB DX-
4	USB DY-
5	USB DX+
6	USB DY+
7	GND
8	GND
9	No Pin
10	NC



- Do not plug the IEEE 1394 bracket (2x5-pin) cable into the USB header.
- Prior to installing the USB bracket, be sure to turn off your computer and unplug the power cord from the power outlet to prevent damage to the USB bracket.

19) F_1394 (IEEE 1394a Header)

The header conforms to IEEE 1394a specification. The IEEE 1394a header can provide one IEEE 1394a port via an optional IEEE 1394a bracket. For purchasing the optional IEEE 1394a bracket(s), please contact the local dealer.

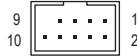
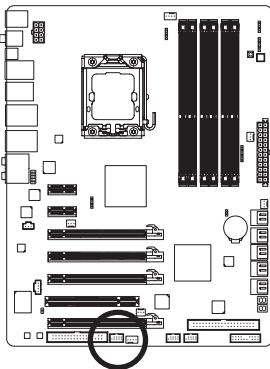

Pin No.	Definition
1	TPA+
2	TPA-
3	GND
4	GND
5	TPB+
6	TPB-
7	Power (12V)
8	Power (12V)
9	No Pin
10	GND



- Do not plug the USB bracket cable into the IEEE 1394a header.
- Prior to installing the IEEE 1394a bracket, be sure to turn off your computer and unplug the power cord from the power outlet to prevent damage to the IEEE 1394a bracket.
- To connect an IEEE 1394a device, attach one end of the device cable to your computer and then attach the other end of the cable to the IEEE 1394a device. Ensure that the cable is securely connected.

Chapter 2 BIOS Setup

BIOS (Basic Input and Output System) records hardware parameters of the system in the CMOS on the motherboard. Its major functions include conducting the Power-On Self-Test (POST) during system startup, saving system parameters and loading operating system, etc. BIOS includes a BIOS Setup program that allows the user to modify basic system configuration settings or to activate certain system features. When the power is turned off, the battery on the motherboard supplies the necessary power to the CMOS to keep the configuration values in the CMOS.

To access the BIOS Setup program, press the <Delete> key during the POST when the power is turned on. To see more advanced BIOS Setup menu options, you can press <Ctrl> + <F1> in the main menu of the BIOS Setup program.

To upgrade the BIOS, use either the GIGABYTE Q-Flash or @BIOS utility.

- Q-Flash allows the user to quickly and easily upgrade or back up BIOS without entering the operating system.
- @BIOS is a Windows-based utility that searches and downloads the latest version of BIOS from the Internet and updates the BIOS.

For instructions on using the Q-Flash and @BIOS utilities, refer to Chapter 4, "BIOS Update Utilities."



- Because BIOS flashing is potentially risky, if you do not encounter problems using the current version of BIOS, it is recommended that you not flash the BIOS. To flash the BIOS, do it with caution. Inadequate BIOS flashing may result in system malfunction.
- BIOS will emit a beep code during the POST. Refer to Chapter 5, "Troubleshooting," for the beep codes description.
- It is recommended that you not alter the default settings (unless you need to) to prevent system instability or other unexpected results. Inadequately altering the settings may result in system's failure to boot. If this occurs, try to clear the CMOS values and reset the board to default values. (Refer to the "Load Optimized Defaults" section in this chapter or introductions of the battery/clearing CMOS jumper in Chapter 1 for how to clear the CMOS values.)

2-1 Startup Screen

The following screens may appear when the computer boots.

A. The LOGO Screen (Default)



Function Keys

B. The POST Screen

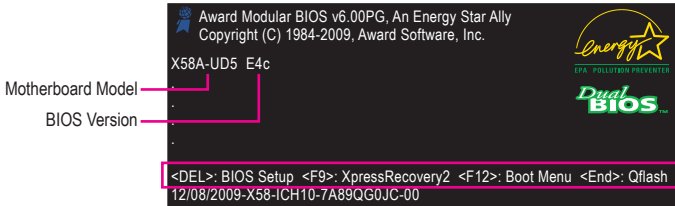

Function Keys

Function Keys:

<TAB>: POST SCREEN

Press the <Tab> key to show the BIOS POST screen. To show the BIOS POST screen at system start-up, refer to the instructions on the **Full Screen LOGO Show** item on page 54.

: BIOS SETUP/Q-FLASH

Press the <Delete> key to enter BIOS Setup or to access the Q-Flash utility in BIOS Setup.

<F9>: XPRESS RECOVERY2

If you have ever entered Xpress Recovery2 to back up hard drive data using the driver disk, the <F9> key can be used for subsequent access to Xpress Recovery2 during the POST. For more information, refer to Chapter 4, "Xpress Recovery2."

<F12>: BOOT MENU

Boot Menu allows you to set the first boot device without entering BIOS Setup. In Boot Menu, use the up arrow key <↑> or the down arrow key <↓> to select the first boot device, then press <Enter> to accept.

To exit Boot Menu, press <Esc>. The system will directly boot from the device configured in Boot Menu.

Note: The setting in Boot Menu is effective for one time only. After system restart, the device boot order will still be based on BIOS Setup settings. You can access Boot Menu again to change the first boot device setting as needed.

<END>: Q-FLASH

Press the <End> key to access the Q-Flash utility directly without having to enter BIOS Setup first.

2-2 The Main Menu

Once you enter the BIOS Setup program, the Main Menu (as shown below) appears on the screen. Use arrow keys to move among the items and press <Enter> to accept or enter a sub-menu.

(Sample BIOS Version: E4c)

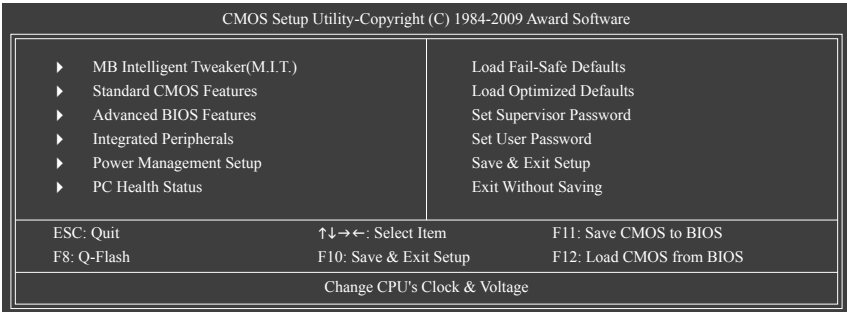

BIOS Setup Program Function Keys

<↑><↓><←><→>	Move the selection bar to select an item
<Enter>	Execute command or enter the submenu
<Esc>	Main Menu: Exit the BIOS Setup program Submenus: Exit current submenu
<Page Up>	Increase the numeric value or make changes
<Page Down>	Decrease the numeric value or make changes
<F1>	Show descriptions of the function keys
<F2>	Move cursor to the Item Help block on the right (submenus only)
<F5>	Restore the previous BIOS settings for the current submenus
<F6>	Load the Fail-Safe BIOS default settings for the current submenu
<F7>	Load the Optimized BIOS default settings for the current submenu
<F8>	Access the Q-Flash utility
<F9>	Display system information
<F10>	Save all the changes and exit the BIOS Setup program
<F11>	Save CMOS to BIOS
<F12>	Load CMOS from BIOS

Main Menu Help

The on-screen description of a highlighted setup option is displayed on the bottom line of the Main Menu.

Submenu Help

While in a submenu, press <F1> to display a help screen (General Help) of function keys available for the menu. Press <Esc> to exit the help screen. Help for each item is in the Item Help block on the right side of the submenu.



- If you do not find the settings you want in the Main Menu or a submenu, press <Ctrl>+<F1> to access more advanced options.
- When the system is not stable as usual, select the **Load Optimized Defaults** item to set your system to its defaults.
- The BIOS Setup menus described in this chapter are for reference only and may differ by BIOS version.

■ The Functions of the <F11> and <F12> keys (For the Main Menu Only)

▶ F11: Save CMOS to BIOS

This function allows you to save the current BIOS settings to a profile. You can create up to 8 profiles (Profile 1-8) and name each profile. First enter the profile name (to erase the default profile name, use the SPACE key) and then press <Enter> to complete.

▶ F12: Load CMOS from BIOS

If your system becomes unstable and you have loaded the BIOS default settings, you can use this function to load the BIOS settings from a profile created before, without the hassles of reconfiguring the BIOS settings. First select the profile you wish to load, then press <Enter> to complete.

■ MB Intelligent Tweaker(M.I.T.)

Use this menu to configure the clock, frequency and voltages of your CPU, memory, etc.

■ Standard CMOS Features

Use this menu to configure the system time and date, hard drive types, floppy disk drive types, and the type of errors that stop the system boot, etc.

■ Advanced BIOS Features

Use this menu to configure the device boot order, advanced features available on the CPU, and the primary display adapter.

■ Integrated Peripherals

Use this menu to configure all peripheral devices, such as IDE, SATA, USB, integrated audio, and integrated LAN, etc.

■ Power Management Setup

Use this menu to configure all the power-saving functions.

■ PC Health Status

Use this menu to see information about autodetected system/CPU temperature, system voltage and fan speed, etc.

■ Load Fail-Safe Defaults

Fail-Safe defaults are factory settings for the most stable, minimal-performance system operations.

■ Load Optimized Defaults

Optimized defaults are factory settings for optimal-performance system operations.

■ Set Supervisor Password

Change, set, or disable password. It allows you to restrict access to the system and BIOS Setup.

A supervisor password allows you to make changes in BIOS Setup.

■ Set User Password

Change, set, or disable password. It allows you to restrict access to the system and BIOS Setup.

A user password only allows you to view the BIOS settings but not to make changes.

■ Save & Exit Setup

Save all the changes made in the BIOS Setup program to the CMOS and exit BIOS Setup. (Pressing <F10> can also carry out this task.)

■ Exit Without Saving

Abandon all changes and the previous settings remain in effect. Pressing <Y> to the confirmation message will exit BIOS Setup. (Pressing <Esc> can also carry out this task.)

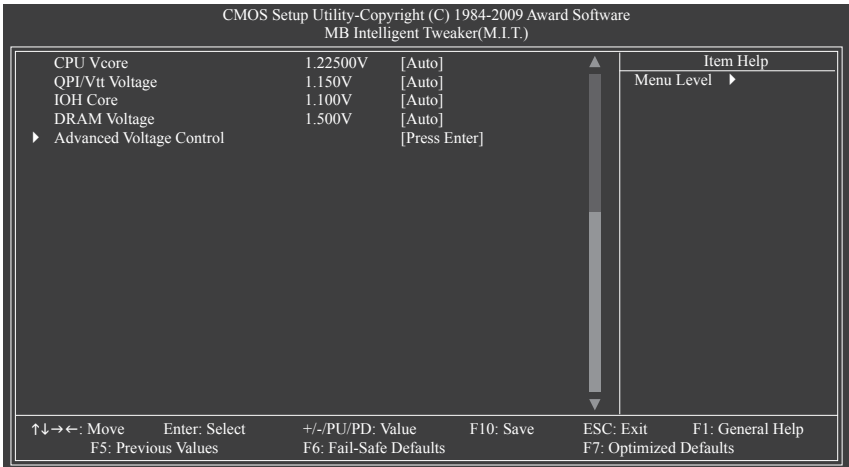

***** **Advanced CPU Features** *****

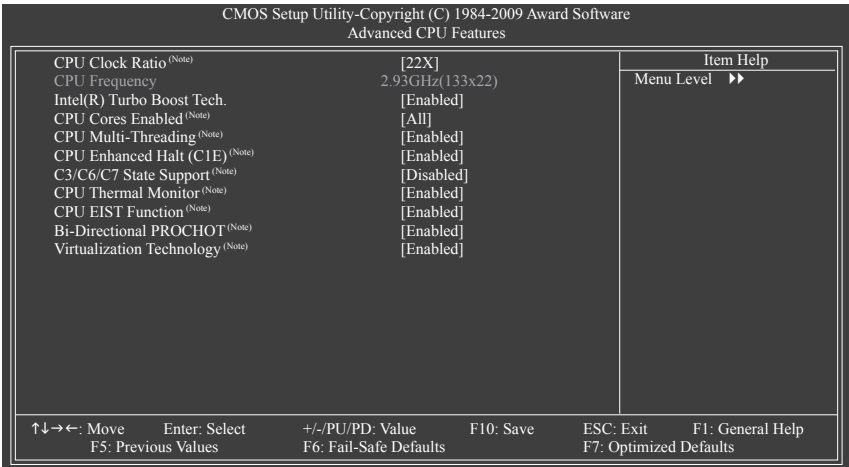

☞ **CPU Clock Ratio** ^(Note)

Allows you to alter the clock ratio for the installed CPU.
The item is present only if a CPU with unlocked clock ratio is installed.

☞ **CPU Frequency**

Displays the current operating CPU frequency.

☞ **Intel(R) Turbo Boost Tech.**

Allows you to determine whether to enable the Intel CPU Turbo Boost technology. (Default: Enabled)

(Note) This item is present only if you install a CPU that supports this feature. For more information about Intel CPUs' unique features, please visit Intel's website.

☞ **CPU Cores Enabled** ^(Note)

Allows you to determine whether to enable all CPU cores.

- ▶▶ All Enables all CPU cores. (Default)
- ▶▶ 1 Enables only one CPU core.
- ▶▶ 2 Enables only two CPU cores.
- ▶▶ 3 Enables only three CPU cores.

☞ **CPU Multi-Threading** ^(Note)

Allows you to determine whether to enable multi-threading technology when using an Intel CPU that supports this function. This feature only works for operating systems that support multi-processor mode. (Default: Enabled)

☞ **CPU Enhanced Halt (C1E)** ^(Note)

Enables or disables Intel CPU Enhanced Halt (C1E) function, a CPU power-saving function in system halt state. When enabled, the CPU core frequency and voltage will be reduced during system halt state to decrease power consumption. (Default: Enabled)

☞ **C3/C6/C7 State Support** ^(Note)

Allows you to determine whether to let the CPU enter C3/C6/C7 mode in system halt state. When enabled, the CPU core frequency and voltage will be reduced during system halt state to decrease power consumption. The C3/C6/C7 state is a more enhanced power-saving state than C1. (Default: Disabled)

☞ **CPU Thermal Monitor** ^(Note)

Enables or disables Intel CPU Thermal Monitor function, a CPU overheating protection function. When enabled, the CPU core frequency and voltage will be reduced when the CPU is overheated. (Default: Enabled)

☞ **CPU EIST Function** ^(Note)

Enables or disables Enhanced Intel SpeedStep Technology (EIST). Depending on CPU loading, Intel EIST technology can dynamically and effectively lower the CPU voltage and core frequency to decrease average power consumption and heat production. (Default: Enabled)

☞ **Bi-Directional PROCHOT** ^(Note)

- ▶▶ Enabled When the CPU or chipset detects that an overheating is occurring, PROCHOT signals will be emitted to lower CPU performance to decrease heat production. (Default)
- ▶▶ Disabled Only allows the CPU to detect whether an overheating is occurring to emit PROCHOT signals.

☞ **Virtualization Technology** ^(Note)

Enables or disables Intel Virtualization Technology. Virtualization enhanced by Intel Virtualization Technology will allow a platform to run multiple operating systems and applications in independent partitions. With virtualization, one computer system can function as multiple virtual systems. (Default: Enabled)

(Note) This item is present only if you install a CPU that supports this feature. For more information about Intel CPUs' unique features, please visit Intel's website.

***** UnCore & QPI Features *****

CMOS Setup Utility-Copyright (C) 1984-2009 Award Software
UnCore & QPI Features

QPI Clock Ratio [Auto] QPI Link Speed 4.8GHz Uncore Clock Ratio [Auto] Uncore Frequency 2133MHz Isochronous Support [Enabled]	Item Help Menu Level ►►
↑↓→←: Move Enter: Select +/-/PU/PD: Value F10: Save ESC: Exit F1: General Help F5: Previous Values F6: Fail-Safe Defaults F7: Optimized Defaults	

☞ **QPI Clock Ratio**

Allows you to set the QPI clock ratio. Options are: Auto (default), x36, x44, x48, Slow Mode.

☞ **Uncore Clock Ratio**

Displays the Uncore clock ratio. Options are: Auto (default), x12~x48.

☞ **Isochronous Support**

Determines whether to enable specific streams between the IOH and ICH. (Default: Enabled)

***** Advanced Clock Control *****

CMOS Setup Utility-Copyright (C) 1984-2009 Award Software
Advanced Clock Control

>>>> Standard Clock Control Base Clock(BCLK) Control [Disabled] x BCLK Frequency(Mhz) 133 PCI Express Frequency(Mhz) [Auto] >>>> Advanced Clock Control CPU Clock Drive [800mV] PCI Express Clock Drive [900mV] CPU Clock Skew [0ps] IOH Clock Skew [0ps]	Item Help Menu Level ►►
↑↓→←: Move Enter: Select +/-/PU/PD: Value F10: Save ESC: Exit F1: General Help F5: Previous Values F6: Fail-Safe Defaults F7: Optimized Defaults	

>>>> Standard Clock Control

☞ Base Clock(BCLK) Control

Enables or disables the control of CPU base clock. **Enabled** will allow the **BCLK Frequency(Mhz)** item below to be configurable. Note: If your system fails to boot after overclocking, please wait for 20 seconds to allow for automated system reboot, or clear the CMOS values to reset the board to default values. (Default: Disabled)

☞ BCLK Frequency(Mhz)

Allows you to manually set the CPU base clock. The adjustable range is from 100 MHz to 1200 MHz. This item is configurable only if the **Base Clock(BCLK) Control** option is enabled.

Important: It is highly recommended that the CPU frequency be set in accordance with the CPU specifications.

☞ PCI Express Frequency(Mhz)

Allows you to manually set the PCIe clock frequency. The adjustable range is from 90 MHz to 150 MHz. **Auto** sets the PCIe clock frequency to standard 100 MHz. (Default: Auto)

>>>> Advanced Clock Control

☞ CPU Clock Drive

Allows you to adjust the amplitude of the CPU and North Bridge clock.
Options are: 700mV, 800mV (default), 900mV, 1000mV.

☞ PCI Express Clock Drive

Allows you to adjust the amplitude of the PCI Express and North Bridge clock.
Options are: 700mV, 800mV, 900mV (default), 1000mV.

☞ CPU Clock Skew

Allows you to set the CPU clock prior to the North Bridge clock.
Options are: 0ps~750ps. (Default: 0ps)

☞ IOH Clock Skew

Allows you to set the North Bridge clock prior to the CPU clock.
Options are: 0ps~750ps. (Default: 0ps)

***** **Advanced DRAM Features** *****

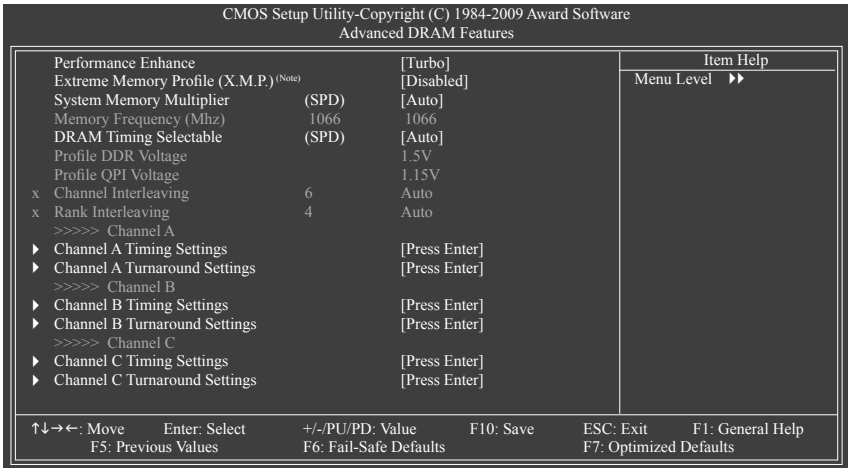

☞ **Performance Enhance**

Allows the system to operate at three different performance levels.

- ▶▶ Standard Lets the system operate at its basic performance level.
- ▶▶ Turbo Lets the system operate at its good performance level. (Default)
- ▶▶ Extreme Lets the system operate at its best performance level.

☞ **Extreme Memory Profile (X.M.P.) ^(Note)**

Allows the BIOS to read the SPD data on XMP memory module(s) to enhance memory performance when enabled.

- ▶▶ Disabled Disables this function. (Default)
- ▶▶ Profile1 Uses Profile 1 settings.
- ▶▶ Profile2 ^(Note) Uses Profile 2 settings.

☞ **System Memory Multiplier (SPD)**

Allows you to set the system memory multiplier. **Auto** sets memory multiplier according to memory SPD data. (Default: Auto)

☞ **Memory Frequency(Mhz)**

The first memory frequency value is the normal operating frequency of the memory being used; the second is the memory frequency that is automatically adjusted according to the **BCLK Frequency(Mhz)** and **System Memory Multiplier** settings.

☞ **DRAM Timing Selectable (SPD)**

Quick or **Expert** allows all DRAM timing control items below to be configurable. Options are: Auto (default), Quick, Expert.

☞ **Profile DDR Voltage**

When using a non-XMP memory module or **Extreme Memory Profile (X.M.P.)** is set to **Disabled**, this item will display as **1.5V**. When **Extreme Memory Profile (X.M.P.)** is set to **Profile1** or **Profile2**, this item will display the value based on the SPD data on the XMP memory.

☞ **Profile QPI Voltage**

The value displayed here is dependent on the CPU being used.

(Note) This item appears only if you install a memory module that supports this feature.

☞ **Channel Interleaving**

Options are: Auto (default), 1-6.

☞ **Rank Interleaving**

Options are: Auto (default), 1-4.

>>>> Channel A/B/C Timing Settings

CMOS Setup Utility-Copyright (C) 1984-2009 Award Software
Channel A Timing Settings

			Item Help
>>>> Channel A Standard Timing Control			Menu Level ▶▶▶
x	CAS Latency Time	7 Auto	
x	tRCD	7 Auto	
x	tRP	7 Auto	
x	tRAS	20 Auto	
>>>> Channel A Advanced Timing Control			
x	tRC	27 Auto	
x	tRRD	4 Auto	
x	tWTR	4 Auto	
x	tWR	8 Auto	
x	tWTP	19 Auto	
x	tWL	7 Auto	
x	tRFC	60 Auto	
x	tRTP	4 Auto	
x	tFAW	20 Auto	
x	Command Rate (CMD)	1 Auto	
>>>> Channel A Misc Timing Control			
x	B2B CAS Delay	- Auto	
x	Round Trip Latency	46 Auto	

↑↓→←: Move Enter: Select +/-/PU/PD: Value F10: Save ESC: Exit F1: General Help
F5: Previous Values F6: Fail-Safe Defaults F7: Optimized Defaults

>>>> Channel A/B/C Standard Timing Control

☞ **CAS Latency Time**

Options are: Auto (default), 6~15.

☞ **tRCD**

Options are: Auto (default), 1~15.

☞ **tRP**

Options are: Auto (default), 1~15.

☞ **tRAS**

Options are: Auto (default), 1~31.

>>>> Channel A/B/C Advanced Timing Control

☞ **tRC**

Options are: Auto (default), 1-63.

☞ **tRRD**

Options are: Auto (default), 1-7.

☞ **tWTR**

Options are: Auto (default), 1~31.

☞ **tWR**

Options are: Auto (default), 1~15.

☞ **tWTP**

Options are: Auto (default), 1~31.

☞ **tWL**

Options are: Auto (default), 1~10.

☞ **tRFC**

Options are: Auto (default), 1~255.

☞ **tRTP**

Options are: Auto (default), 1~15.

☞ **tFAW**

Options are: Auto (default), 1~63.

☞ **Command Rate(CMD)**

Options are: Auto (default), 1~3.

>>>> Channel A/B/C Misc Timing Control

☞ **B2B CAS Delay**

Options are: Auto (default), 1~31.

☞ **Round Trip Latency**

Options are: Auto (default), 1~255.

>>>> Channel A/B/C Turnaround Settings

CMOS Setup Utility-Copyright (C) 1984-2009 Award Software
Channel A Turnaround Settings

>>>> Channel A Reads Followed by Reads			Item Help
x	Different DIMMs	6 Auto	Menu Level ▶▶
x	Different Ranks	5 Auto	
x	On The Same Rank	1 Auto	
>>>> Channel A Writes Followed by Writes			
x	Different DIMMs	6 Auto	
x	Different Ranks	6 Auto	
x	On The Same Rank	1 Auto	

↑↓→←: Move Enter: Select +/-/PU/PD: Value F10: Save ESC: Exit F1: General Help
F5: Previous Values F6: Fail-Safe Defaults F7: Optimized Defaults

>>>> Channel A/B/C Reads Followed by Reads

☞ **Different DIMMs**

Options are: Auto (default), 1~8.

☞ **Different Ranks**

Options are: Auto (default), 1~8.

☞ **On The Same Rank**

Options are: Auto (default), 1~2.

>>>> Channel A/B/C Writes Followed by Writes

☞ Different DIMMs

Options are: Auto (default), 1-8.

☞ Different Ranks

Options are: Auto (default), 1-8.

☞ On The Same Rank

Options are: Auto (default), 1-2.

***** Advanced Voltage Control *****

CMOS Setup Utility-Copyright (C) 1984-2009 Award Software
Advanced Voltage Control

Voltage Types	Normal	Current	Item Help
>>> CPU			Menu Level ▶▶
Load-Line Calibration		[Standard]	
CPU Vcore	1.22500V	[Auto]	
QPI/Vtt Voltage	1.150V	[Auto]	
CPU PLL	1.800V	[Auto]	
>>> MCH/ICH			
PCIE	1.500V	[Auto]	
QPI PLL	1.100V	[Auto]	
IOH Core	1.100V	[Auto]	
ICH I/O	1.500V	[Auto]	
ICH Core	1.100V	[Auto]	
>>> DRAM			
DRAM Voltage	1.500V	[Auto]	
DRAM Termination	0.750V	[Auto]	
Ch-A Data VRef.	0.750V	[Auto]	
Ch-B Data VRef.	0.750V	[Auto]	
Ch-C Data VRef.	0.750V	[Auto]	

↑↓→←: Move Enter: Select +/-/PU/PD: Value F10: Save ESC: Exit F1: General Help
F5: Previous Values F6: Fail-Safe Defaults F7: Optimized Defaults

CMOS Setup Utility-Copyright (C) 1984-2009 Award Software
Advanced Voltage Control

Voltage Types	Normal	Current	Item Help
Ch-A Address VRef.	0.750V	[Auto]	Menu Level ▶▶
Ch-B Address VRef.	0.750V	[Auto]	
Ch-C Address VRef.	0.750V	[Auto]	

↑↓→←: Move Enter: Select +/-/PU/PD: Value F10: Save ESC: Exit F1: General Help
F5: Previous Values F6: Fail-Safe Defaults F7: Optimized Defaults

>>>> CPU

☞ Load-Line Calibration

Enables or disables Load-Line Calibration. This item allows you to adjust Vdroop at different levels. Enabling Load-Line Calibration may keep the CPU voltage more constant under light and heavy CPU load.

- ▶ Standard Disables Load-Line Calibration and sets Vdroop following Intel specifications. (Default)
- ▶ Level 1 Enables Load-Line Calibration and slightly adjusts Vdroop.
- ▶ Level 2 Enables Load-Line Calibration and moderately adjusts Vdroop.

Note: Enabling Load-Line Calibration may result in damage to your CPU or reduce the useful life of the CPU.

☞ CPU Vcore

The default is **Auto**.

☞ QPI/Vtt Voltage

The default is **Auto**.

☞ CPU PLL

The default is **Auto**.

>>>> MCH/ICH

☞ PCIE

The default is **Auto**.

☞ QPI PLL

The default is **Auto**.

☞ IOH Core

The default is **Auto**.

☞ ICH I/O

The default is **Auto**.

☞ ICH Core

The default is **Auto**.

>>>> DRAM

☞ DRAM Voltage

The default is **Auto**.

☞ DRAM Termination

The default is **Auto**.

☞ Ch-A Data VRef.

The default is **Auto**.

☞ Ch-B Data VRef.

The default is **Auto**.

☞ Ch-C Data VRef.

The default is **Auto**.

☞ Ch-A Address VRef.

The default is **Auto**.

☞ Ch-B Address VRef.

The default is **Auto**.

☞ Ch-C Address VRef.

The default is **Auto**.

2-4 Standard CMOS Features

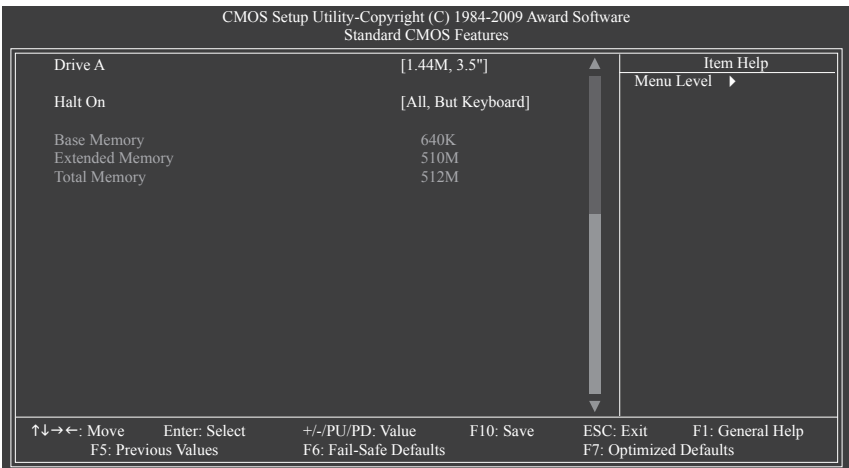
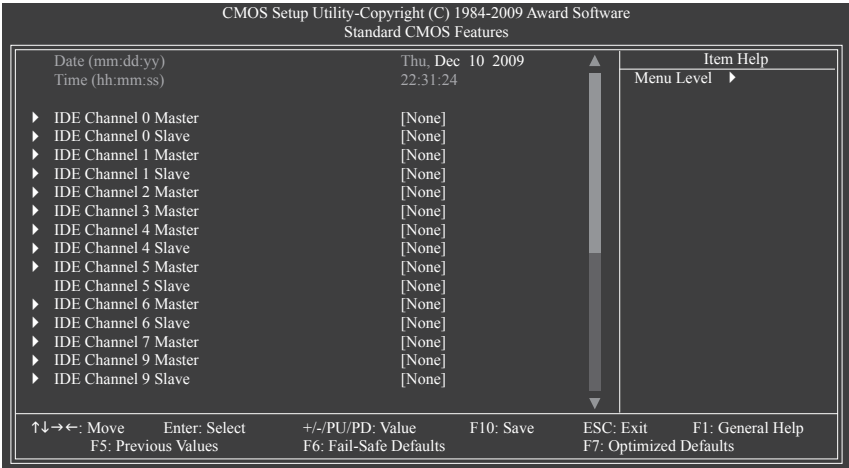

☞ Date (mm:dd:yy)

Sets the system date. The date format is week (read-only), month, date and year. Select the desired field and use the up arrow or down arrow key to set the date.

☞ Time (hh:mm:ss)

Sets the system time. For example, 1 p.m. is 13:0:0. Select the desired field and use the up arrow or down arrow key to set the time.

☞ IDE Channel 0, 1 Master/Slave

▶▶ IDE HDD Auto-Detection

Press <Enter> to autodetect the parameters of the IDE/SATA device on this channel.

▶▶ IDE Channel 0, 1 Master/Slave

Configure your IDE/SATA devices by using one of the three methods below:

- Auto Lets the BIOS automatically detect IDE/SATA devices during the POST. (Default)
- None If no IDE/SATA devices are used, set this item to **None** so the system will skip the detection of the device during the POST for faster system startup.
- Manual Allows you to manually enter the specifications of the hard drive when the hard drive access mode is set to **CHS**.

▶▶ Access Mode Sets the hard drive access mode. Options are: Auto (default), CHS, LBA, Large.

☞ IDE Channel 2, 3 Master, 4, 5, 6 Master/Slave, 7 Master, 9 Master/Slave

▶▶ IDE Auto-Detection

Press <Enter> to autodetect the parameters of the IDE/SATA device on this channel.

▶▶ Extended IDE Drive

Configure your IDE/SATA devices by using one of the two methods below:

- Auto Lets the BIOS automatically detect IDE/SATA devices during the POST. (Default)
- None If no IDE/SATA devices are used, set this item to **None** so the system will skip the detection of the device during the POST for faster system startup.

▶▶ Access Mode Sets the hard drive access mode. Options are: Auto (default), Large.

The following fields display your hard drive specifications. If you wish to enter the parameters manually, refer to the information on the hard drive.

- ▶▶ Capacity Approximate capacity of the currently installed hard drive.
- ▶▶ Cylinder Number of cylinders.
- ▶▶ Head Number of heads.
- ▶▶ Precomp Write precompensation cylinder.
- ▶▶ Landing Zone Landing zone.
- ▶▶ Sector Number of sectors.

☞ Drive A

Allows you to select the type of floppy disk drive installed in your system. If you do not install a floppy disk drive, set this item to **None**. Options are: None, 360K/5.25", 1.2M/5.25", 720K/3.5", 1.44M/3.5", 2.88M/3.5".

☞ Halt On

Allows you to determine whether the system will stop for an error during the POST.

- ▶▶ All Errors Whenever the BIOS detects a non-fatal error the system boot will stop.
- ▶▶ No Errors The system boot will not stop for any error.
- ▶▶ All, But Keyboard The system boot will not stop for a keyboard error but stop for all other errors. (Default)
- ▶▶ All, But Diskette The system boot will not stop for a floppy disk drive error but stop for all other errors.
- ▶▶ All, But Disk/Key The system boot will not stop for a keyboard or a floppy disk drive error but it will stop for all other errors.

☞ Memory

These fields are read-only and are determined by the BIOS POST.

- ▶▶ Base Memory Also called conventional memory. Typically, 640 KB will be reserved for the MS-DOS operating system.
- ▶▶ Extended Memory The amount of extended memory.
- ▶▶ Total Memory The total amount of memory installed on the system.

2-5 Advanced BIOS Features

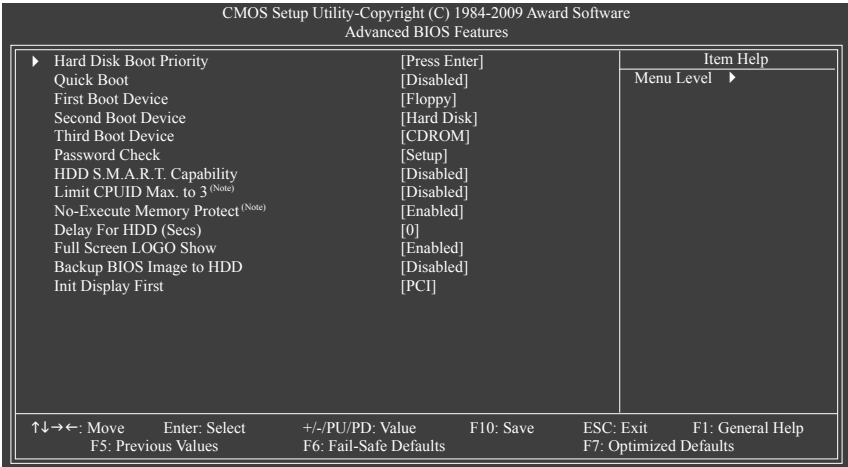

⌘ Hard Disk Boot Priority

Specifies the sequence of loading the operating system from the installed hard drives. Use the up or down arrow key to select a hard drive, then press the plus key <+> (or <PageUp>) or the minus key <-> (or <PageDown>) to move it up or down on the list. Press <Esc> to exit this menu when finished.

⌘ Quick Boot

Enables or disables the quick boot function to speed up the system boot-up process to shorten the waiting time for entering the operating system and to deliver greater efficiency for daily use. The settings here synchronize with the settings of the SMART QuickBoot of Smart 6™. (Default: Disabled)

⌘ First/Second/Third Boot Device

Specifies the boot order from the available devices. Use the up or down arrow key to select a device and press <Enter> to accept. Options are: Floppy, LS120, Hard Disk, CDROM, ZIP, USB-FDD, USB-ZIP, USB-CDROM, USB-HDD, Legacy LAN, Disabled.

⌘ Password Check

Specifies whether a password is required every time the system boots, or only when you enter BIOS Setup. After configuring this item, set the password(s) under the **Set Supervisor/User Password** item in the BIOS Main Menu.

- ▶▶ Setup A password is only required for entering the BIOS Setup program. (Default)
- ▶▶ System A password is required for booting the system and for entering the BIOS Setup program.

⌘ HDD S.M.A.R.T. Capability

Enables or disables the S.M.A.R.T. (Self Monitoring and Reporting Technology) capability of your hard drive. This feature allows your system to report read/write errors of the hard drive and to issue warnings when a third party hardware monitor utility is installed. (Default: Disabled)

(Note) This item is present only if you install a CPU that supports this feature. For more information about Intel CPUs' unique features, please visit Intel's website.

☞ **Limit CPUID Max. to 3** ^(Note)

Allows you to determine whether to limit CPUID maximum value. Set this item to **Disabled** for Windows XP operating system; set this item to **Enabled** for legacy operating system such as Windows NT4.0. (Default: Disabled)

☞ **No-Execute Memory Protect** ^(Note)

Enables or disables Intel Execute Disable Bit function. This function may enhance protection for the computer, reducing exposure to viruses and malicious buffer overflow attacks when working with its supporting software and system. (Default: Enabled)

☞ **Delay For HDD (Secs)**

Allows you to set a delay time for the BIOS to initialize the hard drive as the system boots up. The adjustable range is from 0 to 15 seconds. (Default: 0)

☞ **Full Screen LOGO Show**

Allows you to determine whether to display the GIGABYTE Logo at system startup. **Disabled** displays normal POST message. (Default: Enabled)

☞ **Backup BIOS Image to HDD**

Allows the system to copy the BIOS image file to the hard drive. If the system BIOS is corrupted, it will be recovered from this image file. (Default: Disabled)

☞ **Init Display First**

Specifies the first initiation of the monitor display from the installed PCI graphics card or the PCI Express graphics card.

- ▶▶ PCI Sets the PCI graphics card as the first display. (Default)
- ▶▶ PCIE x16-1 Sets the PCI Express graphics card on the PCIEX16_1 slot as the first display.
- ▶▶ PCIE x16-2 Sets the PCI Express graphics card on the PCIEX16_2 slot as the first display.
- ▶▶ PCIE x8-1 Sets the PCI Express graphics card on the PCIEX8_1 slot as the first display.
- ▶▶ PCIE x8-2 Sets the PCI Express graphics card on the PCIEX8_2 slot as the first display.

(Note) This item is present only if you install a CPU that supports this feature. For more information about Intel CPUs' unique features, please visit Intel's website.

2-6 Integrated Peripherals

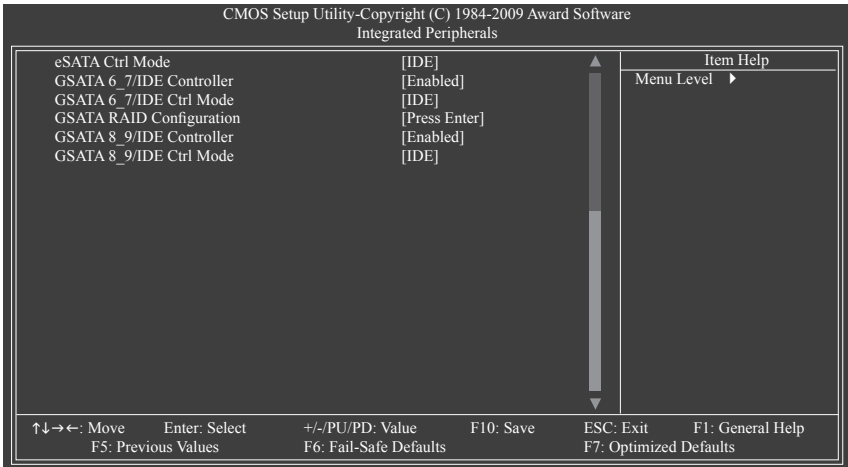
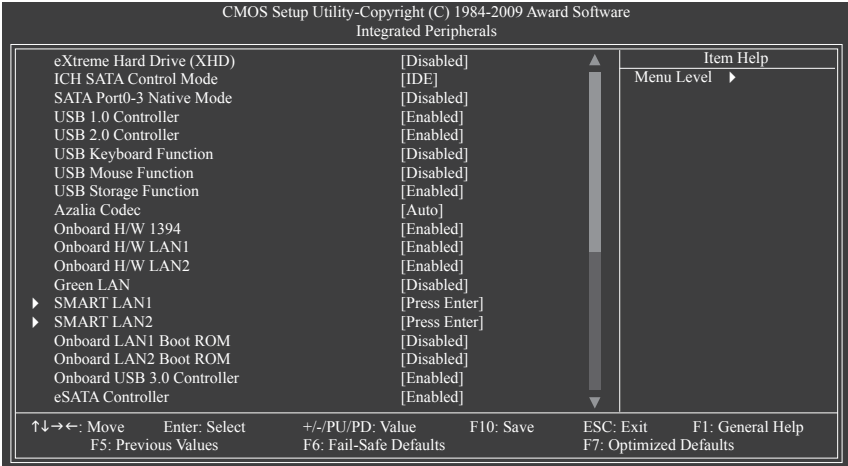

☞ eXtreme Hard Drive (Intel ICH10R Chipset)

Enables or disables the X.H.D function for the SATA controllers integrated in the Intel ICH10R Chipset. When set to **Enabled**, the **ICH SATA Control Mode** item below will be set to **RAID(XHD)** automatically. For details on using the GIGABYTE X.H.D utility, refer to Chapter 4, "eXtreme Hard Drive (X.H.D)." (Default: Disabled)

☞ ICH SATA Control Mode (Intel ICH10R Chipset)

Enables or disables RAID for the SATA controllers integrated in the Intel ICH10R Chipset or configures the SATA controllers to AHCI mode.

- ▶▶ IDE Disables RAID for the SATA controllers and configures the SATA controllers to IDE mode. (Default)

- ▶▶ RAID(XHD) Enables RAID for the SATA controllers.
- ▶▶ AHCI Configures the SATA controllers to AHCI mode. Advanced Host Controller Interface (AHCI) is an interface specification that allows the storage driver to enable advanced Serial ATA features such as Native Command Queuing and hot plug.

☞ **SATA Port0-3 Native Mode (Intel ICH10R South Bridge)**

Specifies the operating mode of the integrated SATA controllers.

- ▶▶ Disabled Allows the SATA controllers to operate in Legacy IDE mode.
In Legacy mode the SATA controllers use dedicated IRQs that cannot be shared with other device. Set this option to **Disabled** if you wish to install operating systems that do not support Native mode. (Default)
- ▶▶ Enabled Allows the SATA controllers to operate in Native IDE mode.
Enable Native IDE mode if you wish to install operating systems that support Native mode.

☞ **USB 1.0 Controller**

Enables or disables the integrated USB 1.0 controller. (Default: Enabled)

Disabled will turn off all of the USB functionalities below.

☞ **USB 2.0 Controller**

Enables or disables the integrated USB 2.0 controller. (Default: Enabled)

☞ **USB Keyboard Function**

Allows USB keyboard to be used in MS-DOS. (Default: Disabled)

☞ **USB Mouse Function**

Allows USB mouse to be used in MS-DOS. (Default: Disabled)

☞ **USB Storage Function**

Determines whether to detect USB storage devices, including USB flash drives and USB hard drives during the POST. (Default: Enabled)

☞ **Azalia Codec**

Enables or disables the onboard audio function. (Default: Auto)

If you wish to install a 3rd party add-in audio card instead of using the onboard audio, set this item to **Disabled**.

☞ **Onboard H/W 1394**

Enables or disables the onboard IEEE 1394 function. (Default: Enabled)

☞ **Onboard H/W LAN1/2**

Enables or disables the onboard LAN function. (Default: Enabled)

If you wish to install a 3rd party add-in network card instead of using the onboard LAN, set this item to **Disabled**.

☞ **Green LAN**

When the onboard LAN function and **Green LAN** are enabled, the system will dynamically detect if a LAN cable is connected or not. If not, the corresponding LAN controller will be disabled automatically. (Default: Disabled)

SMART LAN1/2 (LAN Cable Diagnostic Function)

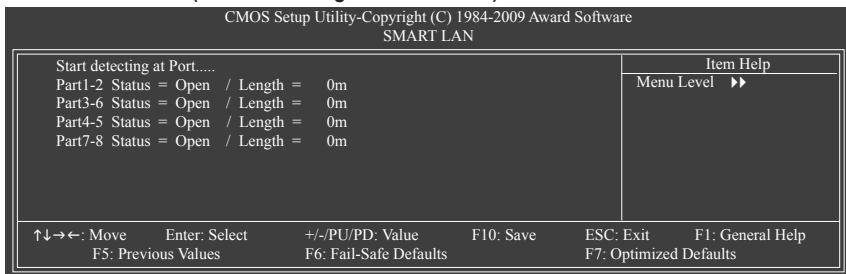

This motherboard incorporates cable diagnostic feature designed to detect the status of the attached LAN cable. This feature will detect cabling issue and report the approximate distance to the fault or short. Refer to the following information for diagnosing your LAN cable:

When No LAN Cable Is Attached...

If no LAN cable is attached to the motherboard, the **Status** fields of all four pairs of wires will show **Open** and the **Length** fields show **0m**, as shown in the figure above.

When LAN Cable Is Functioning Normally...

If no cable problem is detected on the LAN cable connected to a Gigabit hub or a 10/100 Mbps hub, the following message will appear:

```
Start detecting at Port.....
Link Detected --> 100Mbps
Cable Length= 30m
```

- ▶▶ Link Detected Displays transmission speed.
- ▶▶ Cable Length Displays the approximate length of the attached LAN cable.

Note: The Gigabit hub will only operate at a speed of 10/100 Mbps in MS-DOS mode; it will operate at a normal speed of 10/100/1000 Mbps in Windows mode or when the LAN Boot ROM is activated.

When a Cable Problem Occurs...

If a cable problem occurs on a specified pair of wires, the **Status** field will show **Short** and then length shown will be the approximate distance to the fault or short.

Example: Part1-2 Status = Short / Length = 2m

Explanation: A fault or short might occur at about 2m on Part 1-2.

Note: Part 4-5 and Part 7-8 are not used in a 10/100 Mbps environment, so their **Status** fields will show **Open**, and the length shown is the approximate length of the attached LAN cable.

Onboard LAN1/2 Boot ROM

Allows you to decide whether to activate the boot ROM integrated with the onboard LAN chip. (Default: Disabled)

Onboard USB 3.0 Controller (NEC USB 3.0 Controller)

Enables or disables the NEC USB 3.0 controller. (Default: Enabled)

eSATA Controller (JMicron JMB362 Chip, eSATA Connectors)

Enables or disables the SATA controller integrated in the JMicron JMB362 chip. (Default: Enabled)

☞ **eSATA Ctrl Mode (JMicron JMB362 Chip, eSATA Connectors)**

Enables or disables RAID for the SATA controller integrated in the JMicron JMB362 chip or configures the SATA controller to AHCI mode.

- ▶▶ IDE Disables RAID for the SATA controller and configures the SATA controller to IDE mode. (Default)
- ▶▶ AHCI Configures the SATA controller to AHCI mode. Advanced Host Controller Interface (AHCI) is an interface specification that allows the storage driver to enable advanced Serial ATA features such as Native Command Queuing and hot plug.
- ▶▶ RAID Enables RAID for the SATA controller.

☞ **GSATA 6_7/IDE Controller (Marvell 9128 Chip, GSATA3_6/7 Connectors)**

Enables or disables the SATA controller integrated in the Marvell 9128 chip. (Default: Enabled)

☞ **GSATA 6_7/IDE Ctrl Mode (Marvell 9128 Chip, GSATA3_6/7 Connectors)**

Allows you to decide whether to configure the SATA controller integrated in the Marvell 9128 chip to AHCI mode.

- ▶▶ IDE Configures the SATA controller to IDE mode. (Default)
- ▶▶ AHCI Configures the SATA controller to AHCI mode. Advanced Host Controller Interface (AHCI) is an interface specification that allows the storage driver to enable advanced Serial ATA features such as Native Command Queuing and hot plug.

☞ **GSATA RAID Configuration (Marvell 9128 Chip, GSATA3_6/7 Connectors)**

Allows you to configure RAID for the Marvell 9128 SATA controller. Refer to Chapter 5, "Configuring SATA Hard Drive(s)," for instructions on configuring a RAID array.

☞ **GSATA 8_9/IDE Controller (GIGABYTE SATA2 Chip, IDE and GSATA2_8/9 Connectors)**

Enables or disables the IDE and SATA controller integrated in the GIGABYTE SATA2 chip. (Default: Enabled)

☞ **GSATA 8_9/IDE Ctrl Mode (GIGABYTE SATA2 Chip, IDE and GSATA2_8/9 Connectors)**

Enables or disables RAID for the SATA controller integrated in the GIGABYTE SATA2 chip or configures the SATA controller to AHCI mode.

- ▶▶ IDE Configures the SATA controller to IDE mode. (Default)
- ▶▶ AHCI Configures the SATA controller to AHCI mode. Advanced Host Controller Interface (AHCI) is an interface specification that allows the storage driver to enable advanced Serial ATA features such as Native Command Queuing and hot plug.
- ▶▶ RAID/IDE Enables RAID for the SATA controller; the IDE controller still operates in IDE mode.

2-7 Power Management Setup

CMOS Setup Utility-Copyright (C) 1984-2009 Award Software		
Power Management Setup		
		Item Help
ACPI Suspend Type	[S3(STR)]	Menu Level ▶
Soft-Off by PWR-BTTN	[Instant-Off]	
PME Event Wake Up	[Enabled]	
Power On by Ring	[Enabled]	
Resume by Alarm	[Disabled]	
x Date (of Month) Alarm	Everyday	
x Time (hh:mm:ss) Alarm	0 : 0 : 0	
HPET Support ^(Note)	[Enabled]	
HPET Mode ^(Note)	[32-bit mode]	
Power On by Mouse	[Disabled]	
Power On by Keyboard	[Disabled]	
x KB Power ON Password	Enter	
AC Back Function	[Soft-Off]	
EuP Support	[Disabled]	

↑↓→←: Move	Enter: Select	+/-/PU/PD: Value	F10: Save	ESC: Exit	F1: General Help
F5: Previous Values		F6: Fail-Safe Defaults		F7: Optimized Defaults	

ACPI Suspend Type

Specifies the ACPI sleep state when the system enters suspend.

- ▶▶ S1(POS) Enables the system to enter the ACPI S1 (Power on Suspend) sleep state. In S1 sleep state, the system appears suspended and stays in a low power mode. The system can be resumed at any time.
- ▶▶ S3(STR) Enables the system to enter the ACPI S3 (Suspend to RAM) sleep state (default). In S3 sleep state, the system appears to be off and consumes less power than in the S1 state. When signaled by a wake-up device or event, the system resumes to its working state exactly where it was left off.

Soft-Off by PWR-BTTN

Configures the way to turn off the computer in MS-DOS mode using the power button.

- ▶▶ Instant-Off Press the power button and then the system will be turned off instantly. (Default)
- ▶▶ Delay 4 Sec. Press and hold the power button for 4 seconds to turn off the system. If the power button is pressed for less than 4 seconds, the system will enter suspend mode.

PME Event Wake Up

Allows the system to be awakened from an ACPI sleep state by a wake-up signal from a PCI or PCIe device. Note: To use this function, you need an ATX power supply providing at least 1A on the +5VSB lead. (Default: Enabled)

Power On by Ring

Allows the system to be awakened from an ACPI sleep state by a wake-up signal from a modem that supports wake-up function. (Default: Enabled)

(Note) Supported on Windows 7/Vista operating system only.

☞ Resume by Alarm

Determines whether to power on the system at a desired time. (Default: Disabled)

If enabled, set the date and time as following:

▶▶ Date (of Month) Alarm: Turn on the system at a specific time on each day or on a specific day in a month.

▶▶ Time (hh: mm: ss) Alarm: Set the time at which the system will be powered on automatically.

Note: When using this function, avoid inadequate shutdown from the operating system or removal of the AC power, or the settings may not be effective.

☞ HPET Support ^(Note)

Enables or disables High Precision Event Timer (HPET) for Windows Vista operating system. (Default: Enabled)

☞ HPET Mode ^(Note)

Allows you to select the HPET mode for your Windows Vista operating system. Select **32-bit mode** when you install 32-bit Windows Vista; select **64-bit mode** when you install 64-bit Windows Vista. This item is configurable only if the **HPET Support** is set to **Enabled**. (Default: 32-bit mode)

☞ Power On By Mouse

Allows the system to be turned on by a PS/2 mouse wake-up event.

Note: To use this function, you need an ATX power supply providing at least 1A on the +5VSB lead.

▶▶ Disabled Disables this function. (Default)

▶▶ Double Click Double click on left button on the PS/2 mouse to turn on the system.

☞ Power On By Keyboard

Allows the system to be turned on by a PS/2 keyboard wake-up event.

Note: you need an ATX power supply providing at least 1A on the +5VSB lead.

▶▶ Disabled Disables this function. (Default)

▶▶ Password Set a password with 1~5 characters to turn on the system.

▶▶ Keyboard 98 Press POWER button on the Windows 98 keyboard to turn on the system.

☞ KB Power ON Password

Set the password when **Power On by Keyboard** is set to **Password**. Press <Enter> on this item and set a password with up to 5 characters and then press <Enter> to accept. To turn on the system, enter the password and press <Enter>.

Note: To cancel the password, press <Enter> on this item. When prompted for the password, press <Enter> again without entering the password to clear the password settings.

☞ AC Back Function

Determines the state of the system after the return of power from an AC power loss.

▶▶ Soft-Off The system stays off upon the return of the AC power. (Default)

▶▶ Full-On The system is turned on upon the return of the AC power.

▶▶ Memory The system returns to its last known awake state upon the return of the AC power.

☞ EuP Support

Determines whether to let the system consume less than 1W power in S5 (shutdown) state. (Default: Disabled)

Note: When this item is set to Enabled, the following four functions will become unavailable:

PME event wake up, power on by mouse, power on by keyboard, and wake on LAN.

(Note) Supported on Windows 7/Vista operating system only.

2-8 PC Health Status

CMOS Setup Utility-Copyright (C) 1984-2009 Award Software		
PC Health Status		
		Item Help
Reset Case Open Status	[Disabled]	Menu Level ▶
Case Opened	No	
Vcore	1.220V	
DDR15V	1.504V	
+3.3V	2.960V	
+5V	4.730V	
+12V	12.048V	
Current CPU Temperature	47°C	
Current MCH Temperature	42°C	
Current CPU FAN Speed	3375 RPM	
Current SYSTEM FAN2 Speed	0 RPM	
Current POWER FAN Speed	0 RPM	
Current SYSTEM FAN1 Speed	0 RPM	
CPU Warning Temperature	[Disabled]	
CPU FAN Fail Warning	[Disabled]	
CPU Smart FAN Control	[Enabled]	
CPU Smart FAN Mode	[Auto]	
↑↓→←: Move Enter: Select +/-/PU/PD: Value F10: Save ESC: Exit F1: General Help F5: Previous Values F6: Fail-Safe Defaults F7: Optimized Defaults		

Reset Case Open Status

Keeps or clears the record of previous chassis intrusion status. **Enabled** clears the record of previous chassis intrusion status and the **Case Opened** field will show "No" at next boot. (Default: Disabled)

Case Opened

Displays the detection status of the chassis intrusion detection device attached to the motherboard CI header. If the system chassis cover is removed, this field will show "Yes", otherwise it will show "No". To clear the chassis intrusion status record, set **Reset Case Open Status** to **Enabled**, save the settings to the CMOS, and then restart your system.

Current Voltage(V) Vcore/DDR15V/+3.3V/+5V/+12V

Displays the current system voltages.

Current CPU/MCH Temperature

Displays current CPU/North Bridge temperature.

Current CPU/SYSTEM/POWER FAN Speed (RPM)

Displays current CPU/system/power fan speed.

CPU Warning Temperature

Sets the warning threshold for CPU temperature. When CPU temperature exceeds the threshold, BIOS will emit warning sound. Options are: Disabled (default), 60°C/140°F, 70°C/158°F, 80°C/176°F, 90°C/194°F.

CPU FAN Fail Warning

Allows the system to emit warning sound if the CPU/system/power fan is not connected or fails. Check the fan condition or fan connection when this occurs. (Default: Disabled)

CPU Smart FAN Control

Enables or disables the CPU fan speed control function. **Enabled** allows the CPU fan to run at different speed according to the CPU temperature. You can adjust the fan speed with EasyTune based on system requirements. If disabled, the CPU fan runs at full speed. (Default: Enabled)

☞ CPU Smart FAN Mode

Specifies how to control CPU fan speed. This item is configurable only if **CPU Smart FAN Control** is set to **Enabled**.

- ▶▶ Auto Lets the BIOS automatically detect the type of CPU fan installed and sets the optimal CPU fan control mode. (Default)
- ▶▶ Voltage Sets Voltage mode for a 3-pin CPU fan.
- ▶▶ PWM Sets PWM mode for a 4-pin CPU fan.

Note: The **Voltage** mode can be set for a 3-pin CPU fan or a 4-pin CPU fan. However, for a 4-pin CPU fan that is not designed following Intel PWM fan specifications, selecting **PWM** mode may not effectively reduce the fan speed.

2-9 Load Fail-Safe Defaults

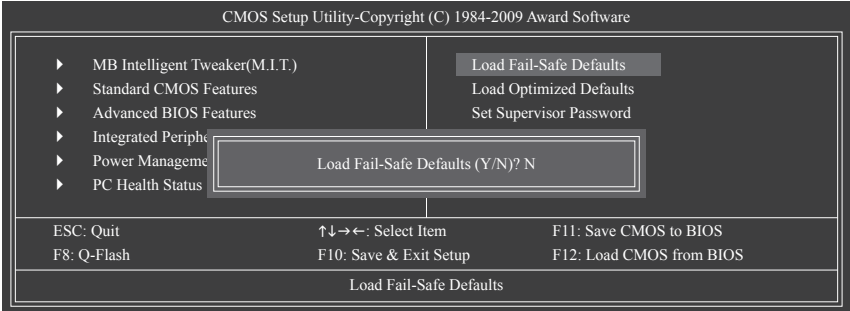

Press <Enter> on this item and then press the <Y> key to load the safest BIOS default settings. In case system instability occurs, you may try to load Fail-Safe defaults, which are the safest and most stable BIOS settings for the motherboard.

2-10 Load Optimized Defaults

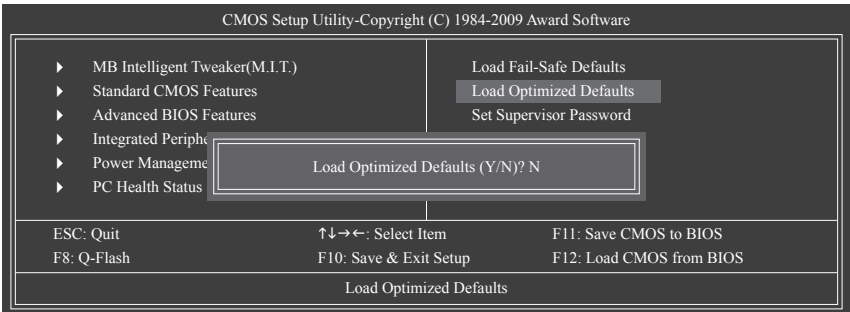

Press <Enter> on this item and then press the <Y> key to load the optimal BIOS default settings. The BIOS defaults settings help the system to operate in optimum state. Always load the Optimized defaults after updating the BIOS or after clearing the CMOS values.

2-11 Set Supervisor/User Password

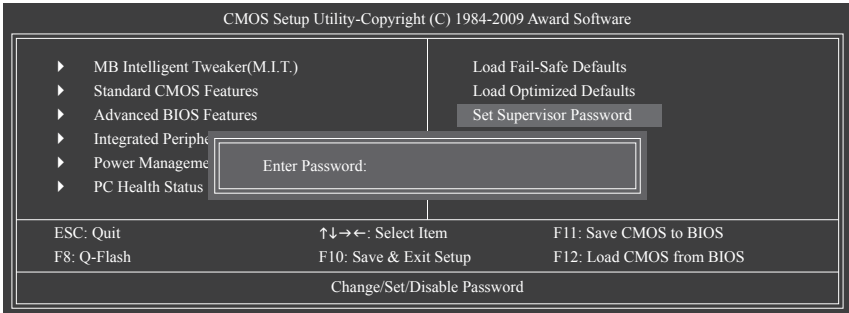

Press <Enter> on this item and type the password with up to 8 characters and then press <Enter>. You will be requested to confirm the password. Type the password again and press <Enter>.

The BIOS Setup program allows you to specify two separate passwords:

☞ Supervisor Password

When a system password is set and the **Password Check** item in **Advanced BIOS Features** is set to **Setup**, you must enter the supervisor password for entering BIOS Setup and making BIOS changes.

When the **Password Check** item is set to **System**, you must enter the supervisor password (or user password) at system startup and when entering BIOS Setup.

☞ User Password

When the **Password Check** item is set to **System**, you must enter the supervisor password (or user password) at system startup to continue system boot. In BIOS Setup, you must enter the supervisor password if you wish to make changes to BIOS settings. The user password only allows you to view the BIOS settings but not to make changes.

To clear the password, press <Enter> on the password item and when requested for the password, press <Enter> again. The message "PASSWORD DISABLED" will appear, indicating the password has been cancelled.

2-12 Save & Exit Setup

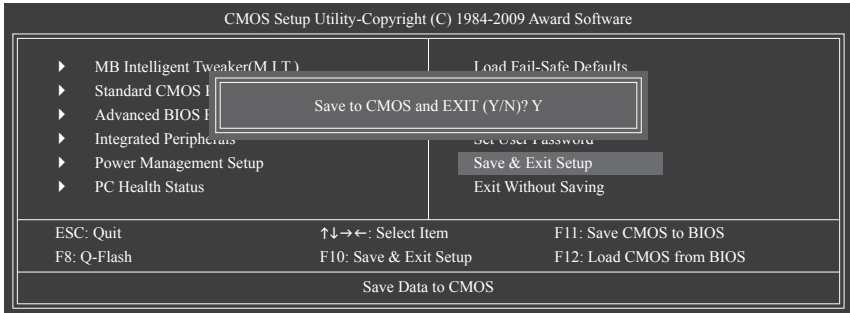

Press <Enter> on this item and press the <Y> key. This saves the changes to the CMOS and exits the BIOS Setup program. Press <N> or <Esc> to return to the BIOS Setup Main Menu.

2-13 Exit Without Saving

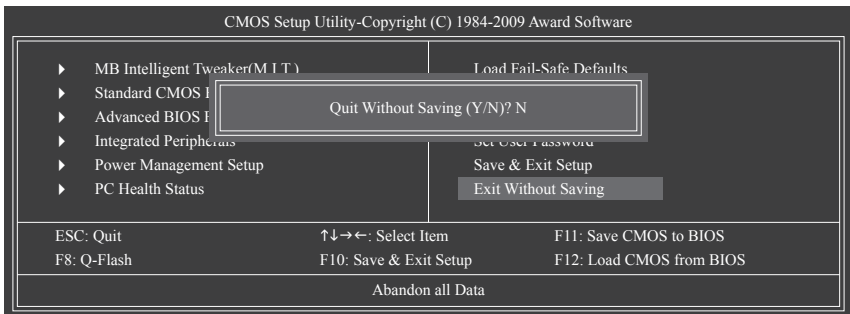

Press <Enter> on this item and press the <Y> key. This exits the BIOS Setup without saving the changes made in BIOS Setup to the CMOS. Press <N> or <Esc> to return to the BIOS Setup Main Menu.

Chapter 3 Drivers Installation



- Before installing the drivers, first install the operating system.
- After installing the operating system, insert the motherboard driver disk into your optical drive. The driver Autorun screen is automatically displayed which looks like that shown in the screen shot below. (If the driver Autorun screen does not appear automatically, go to My Computer, double-click the optical drive and execute the **Run.exe** program.)

3-1 Installing Chipset Drivers



Now Loading Please wait...

After inserting the driver disk, "Xpress Install" will automatically scan your system and then list all the drivers that are recommended to install. You can click the **Install All** button and "Xpress Install" will install all the recommended drivers. Or click **Install Single Items** to manually select the drivers you wish to install.

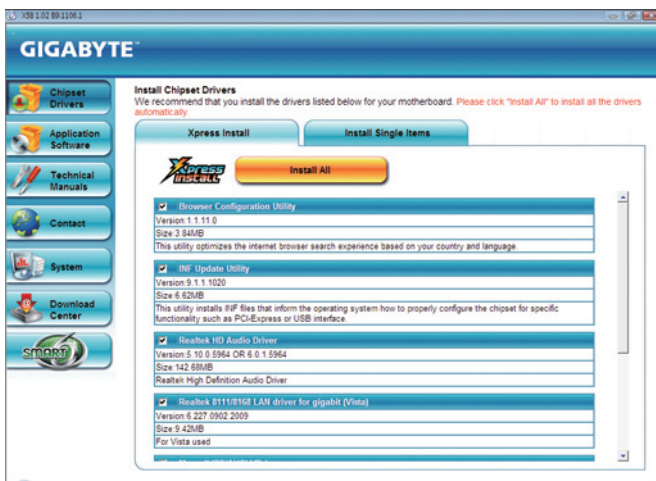

- Please ignore the popup dialog box(es) (e.g. the **Found New Hardware Wizard**) displayed when "Xpress Install" is installing the drivers. Failure to do so may affect the driver installation.
- Some device drivers will restart your system automatically during the driver installation. After the system restart, "Xpress Install" will continue to install other drivers.
- After the drivers are installed, follow the on-screen instructions to restart your system. You can install other applications included in the motherboard driver disk.
- For USB 2.0 driver support under the Windows XP operating system, please install the Windows XP Service Pack 1 or later. After installing the SP1 (or later), if a question mark still exists in **Universal Serial Bus Controller** in **Device Manager**, please remove the question mark (by right-clicking your mouse and select **Uninstall**) and restart the system. (The system will then autodetect and install the USB 2.0 driver.)

3-2 Application Software

This page displays all the utilities and applications that GIGABYTE develops and some free software. You can click the **Install** button on the right of an item to install it.

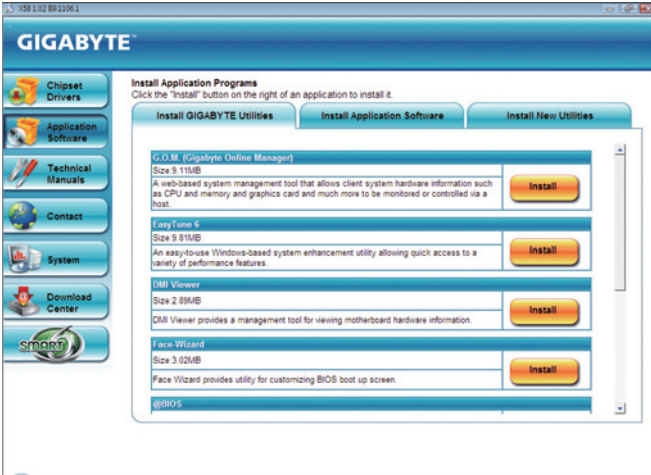

3-3 Technical Manuals

This page provides GIGABYTE's application guides, content descriptions for this driver disk, and the motherboard manuals.

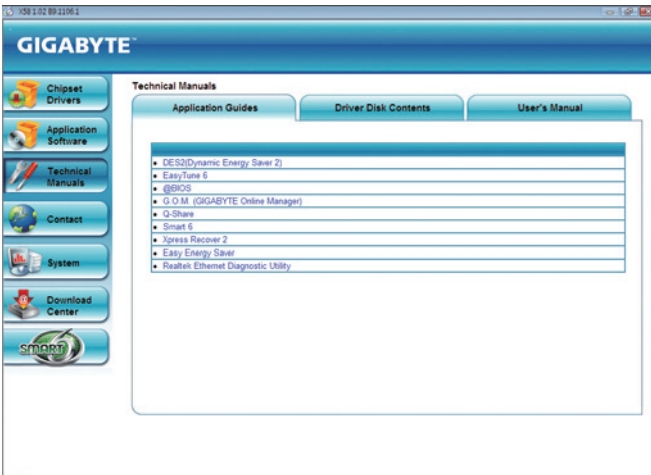

3-4 Contact

For the detailed contact information of the GIGABYTE Taiwan headquarter or worldwide branch offices, click the URL on this page to link to the GIGABYTE website.

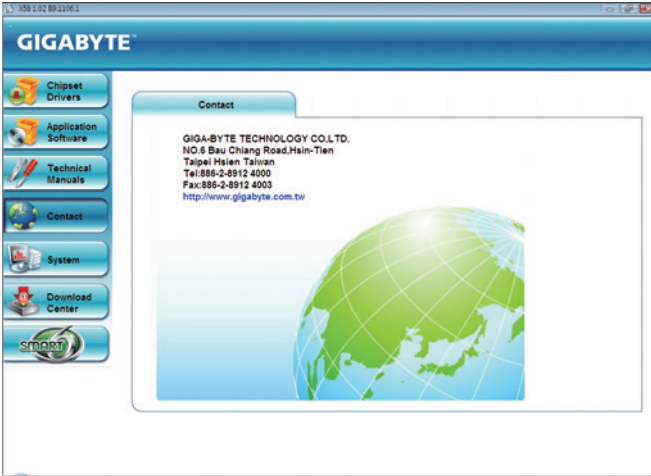

3-5 System

This page provides the basic system information.

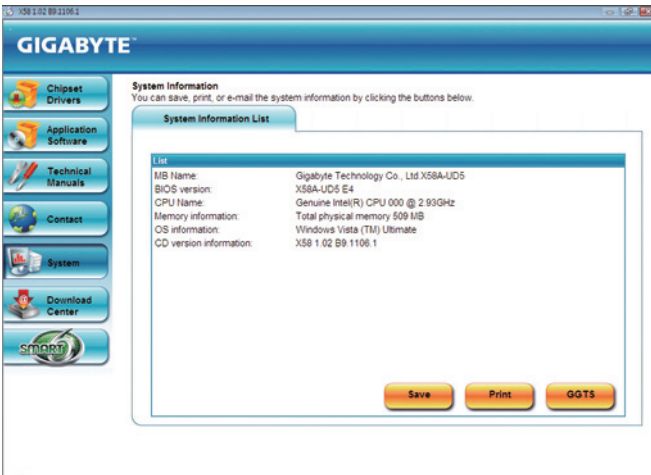

3-6 Download Center

To update the BIOS, drivers, or applications, click the **Download Center** button to link to the GIGABYTE website. The latest version of the BIOS, drivers, or applications will be displayed.

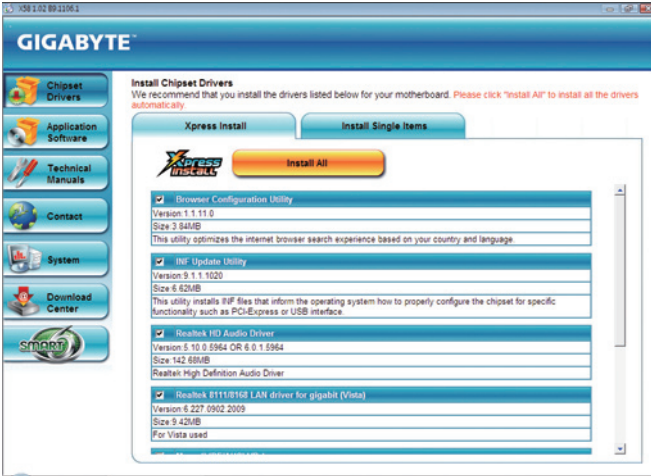

3-7 New Utilities

This page provides a quick link to GIGABYTE's lately developed utilities for users to install. You can click the **Install** button on the right of an item to install it.

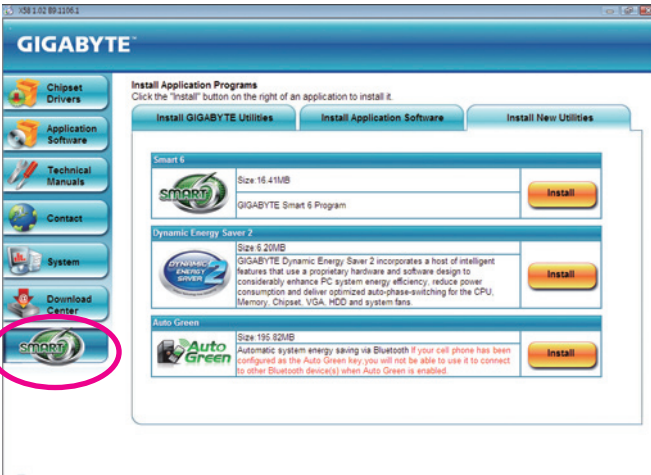

Chapter 4 Unique Features

4-1 Xpress Recovery2



Xpress Recovery2 is a utility that allows you to quickly compress and back up your system data and perform restoration of it. Supporting NTFS, FAT32, and FAT16 file systems, Xpress Recovery2 can back up data on PATA and SATA hard drives and restore it.

Before You Begin:

- Xpress Recovery2 will check the first physical hard drive^(Note) for the operating system. Xpress Recovery2 can only back up/restore the first physical hard drive that has the operating system installed.
- As Xpress Recovery2 will save the backup file at the end of the hard drive, make sure to leave enough un-allocated space in advanced (10 GB or more is recommended; actual size requirements vary, depending on the amount of data).
- It is recommended to back up your system soon after the operating system and drivers are installed.
- The amount of data and hard drive access speed may affect the speed at which the data is backed up/ restored.
- It takes longer to back up a hard drive than to restore it.

System Requirements:

- At least 512 MB of system memory
- VESA compatible graphics card
- Windows XP with SP1 or later, Windows Vista



- Xpress Recovery and Xpress Recovery2 are different utilities. For example, a backup file created with Xpress Recovery cannot be restored using Xpress Recovery2.
- USB hard drives are not supported.
- Hard drives in RAID/AHCI mode are not supported.

Installation and Configuration:

Turn on your system to boot from the Windows Vista setup disk.

A. Installing Windows Vista and Partitioning the Hard Drive

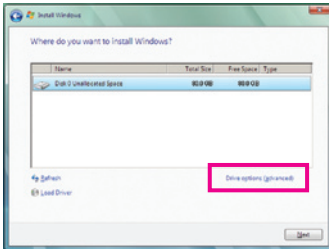

Step 1:

Click **Drive options**.

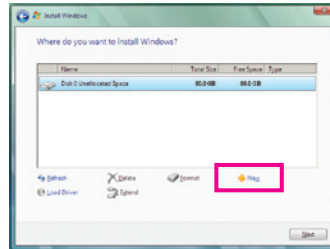

Step 2:

Click **New**.

(Note) Xpress Recovery2 checks the first physical hard drive in the following sequence: The first PATA IDE connector, the second PATA IDE connector, the first SATA connector, the second SATA connector and so forth. For example, when hard drives are attached to the first IDE and the first SATA connectors, the hard drive on the first IDE connector is the first physical drive. When hard drives are attached to the first and second SATA connectors, the hard drive on the first SATA connector is the first physical drive.

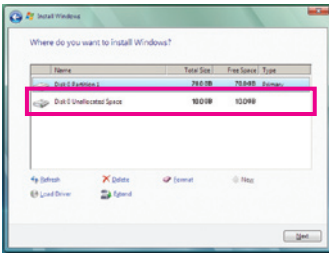

Step 3:

When partitioning your hard drive, make sure to leave unallocated space (10 GB or more is recommended; actual size requirements vary, depending on the amount of data) and begin the installation of the operating system.



Step 4:

After the operating system is installed, right-click the **Computer** icon on your desktop and select the **Manage**. Go to **Disk Management** to check disk allocation.

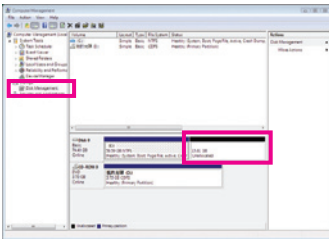

Step 5:

Xpress Recovery2 will save the backup file to the unallocated space (black stripe along the top). Please note that if there is not enough unallocated space, Xpress Recovery2 cannot save the backup file.

B. Accessing Xpress Recovery2

1. Boot from the motherboard driver disk to access Xpress Recovery2 for the first time. When you see the following message: *Press any key to startup Xpress Recovery2*, press any key to enter Xpress Recovery2.
2. After you use the backup function in Xpress Recovery2 for the first time, Xpress Recovery2 will set permanent in your hard drive. If you wish to enter Xpress Recovery2 later, simply press <F9> during the POST.

C. Using the Backup Function in Xpress Recovery2



Step 1:

Select **BACKUP** to start backing up your hard drive data.

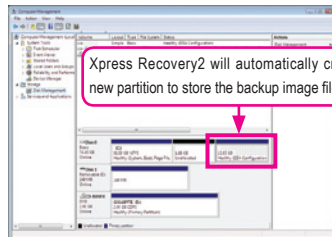

Step 2:

When finished, go to **Disk Management** to check disk allocation.

D. Using the Restore Function in Xpress Recovery2



Select **RESTORE** to restore the backup to your hard drive in case the system breaks down. The **RESTORE** option will not be present if no backup is created before.

E. Removing the Backup



Step 1:

If you wish to remove the backup file, select **REMOVE**.

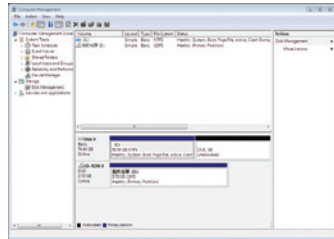

Step 2:

After the backup file is removed, no backup image file will be present in **Disk Management** and hard drive space will be freed up.

F. Exiting Xpress Recovery2



Select **REBOOT** to exit Xpress Recovery2.

4-2 BIOS Update Utilities

GIGABYTE motherboards provide two unique BIOS update tools, Q-Flash™ and @BIOS™. GIGABYTE Q-Flash and @BIOS are easy-to-use and allow you to update the BIOS without the need to enter MS-DOS mode. Additionally, this motherboard features the DualBIOS™ design, which enhances protection for the safety and stability of your computer by adding one more physical BIOS chip.



What is DualBIOS™?

Motherboards that support DualBIOS have two BIOS onboard, a main BIOS and a backup BIOS. Normally, the system works on the main BIOS. However, if the main BIOS is corrupted or damaged, the backup BIOS will take over on the next system boot and copy the BIOS file to the main BIOS to ensure normal system operation. For the sake of system safety, users cannot update the backup BIOS manually.



What is Q-Flash™?

With Q-Flash you can update the system BIOS without having to enter operating systems like MS-DOS or Windows first. Embedded in the BIOS, the Q-Flash tool frees you from the hassles of going through complicated BIOS flashing process.



What is @BIOS™?

@BIOS allows you to update the system BIOS while in the Windows environment. @BIOS will download the latest BIOS file from the nearest @BIOS server site and update the BIOS.

4-2-1 Updating the BIOS with the Q-Flash Utility

A. Before You Begin

1. From GIGABYTE's website, download the latest compressed BIOS update file that matches your motherboard model.
2. Extract the file and save the new BIOS file (e.g. X58AUD5.f1) to your floppy disk, USB flash drive, or hard drive. Note: The USB flash drive or hard drive must use FAT32/16/12 file system.
3. Restart the system. During the POST, press the <End> key to enter Q-Flash. Note: You can access Q-Flash by either pressing the <End> key during the POST or pressing the <F8> key in BIOS Setup. However, if the BIOS update file is saved to a hard drive in RAID/AHCI mode or a hard drive attached to an independent IDE/SATA controller, use the <End> key during the POST to access Q-Flash.

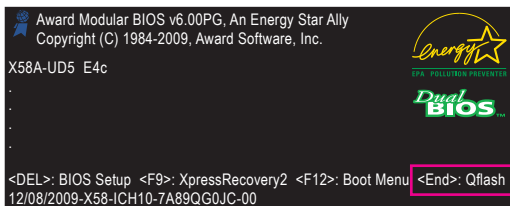

Because BIOS flashing is potentially risky, please do it with caution. Inadequate BIOS flashing may result in system malfunction.

B. Updating the BIOS

When updating the BIOS, choose the location where the BIOS file is saved. The following procedure assumes that you save the BIOS file to a floppy disk.

Step 1:

1. Insert the floppy disk containing the BIOS file into the floppy disk drive. In the main menu of Q-Flash, use the up or down arrow key to select **Update BIOS from Drive** and press <Enter>.



- The **Save Main BIOS to Drive** option allows you to save the current BIOS file.
- Q-Flash only supports USB flash drive or hard drives using FAT32/16/12 file system.
- If the BIOS update file is saved to a hard drive in RAID/AHCI mode or a hard drive attached to an independent IDE/SATA controller, use the <End> key during the POST to access Q-Flash.

2. Select **Floppy A** and press <Enter>.

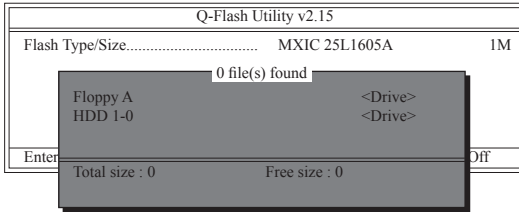

3. Select the BIOS update file and press <Enter>.



Make sure the BIOS update file matches your motherboard model.

Step 2:

The process of the system reading the BIOS file from the floppy disk is displayed on the screen. When the message "Are you sure to update BIOS?" appears, press <Enter> to begin the BIOS update. The monitor will display the update process.



- **Do not turn off or restart the system when the system is reading/updating the BIOS.**
- **Do not remove the floppy disk, USB flash drive, or hard drive when the system is updating the BIOS.**

Step 3:

When the update process is complete, press any key to return to the main menu.

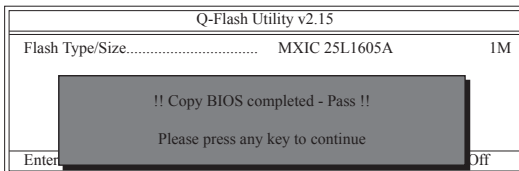

Step 4:

Press <Esc> and then <Enter> to exit Q-Flash and reboot the system. As the system boots, you should see the new BIOS version is present on the POST screen.

Step 5:

During the POST, press <Delete> to enter BIOS Setup. Select **Load Optimized Defaults** and press <Enter> to load BIOS defaults. System will re-detect all peripheral devices after a BIOS update, so we recommend that you reload BIOS defaults.

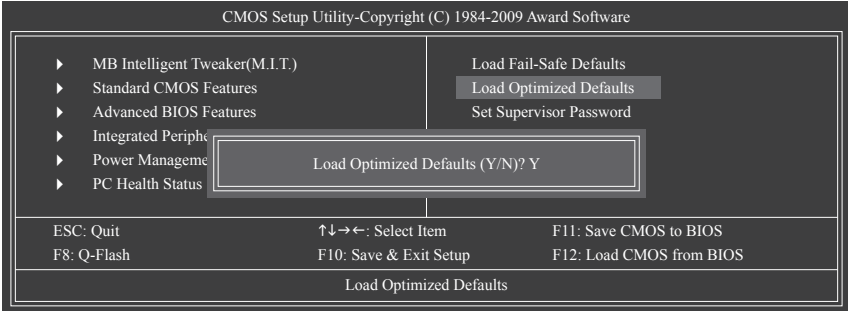

Press <Y> to load BIOS defaults

Step 6:

Select **Save & Exit Setup** and then press <Y> to save settings to CMOS and exit BIOS Setup. The procedure is complete after the system restarts.

4-2-2 Updating the BIOS with the @BIOS Utility

A. Before You Begin

1. In Windows, close all applications and TSR (Terminate and Stay Resident) programs. This helps prevent unexpected failures when performing a BIOS update.
2. During the BIOS update process, ensure the Internet connection is stable and do NOT interrupt the Internet connection (for example, avoid a power loss or switching off the Internet). Failure to do so may result in a corrupted BIOS or a system that is unable to start.
3. Do not use the G.O.M. (GIGABYTE Online Management) function when using @BIOS.
4. GIGABYTE product warranty does not cover any BIOS damage or system failure resulting from an inadequate BIOS flashing.

B. Using @BIOS

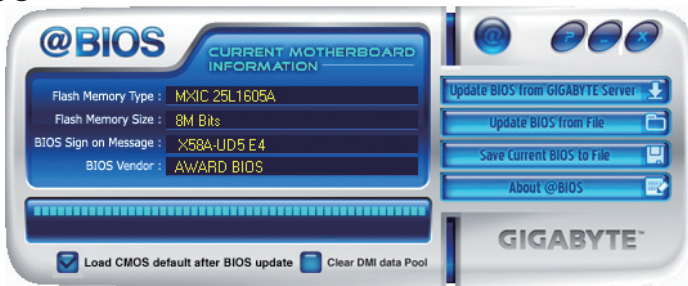

1. Update the BIOS Using the Internet Update Function:

Click **Update BIOS from GIGABYTE Server**, select the @BIOS server site closest to your location and then download the BIOS file that matches your motherboard model. Follow the on-screen instructions to complete.



If the BIOS update file for your motherboard is not present on the @BIOS server site, please manually download the BIOS update file from GIGABYTE's website and follow the instructions in "Update the BIOS without Using the Internet Update Function" below.

2. Update the BIOS without Using the Internet Update Function:

Click **Update BIOS from File**, then select the location where you save the BIOS update file obtained from the Internet or through other source. Follow the on-screen instructions to complete.

3. Save the Current BIOS File:

Click **Save Current BIOS to File** to save the current BIOS file.

4. Load BIOS Defaults after BIOS Update:

Select the **Load CMOS default after BIOS update** check box and then the system will automatically load BIOS defaults after BIOS update and after the system restarts.

C. After Updating the BIOS

Restart your system after updating the BIOS.



Make sure that the BIOS file to be flashed matches your motherboard model. Updating the BIOS with an incorrect BIOS file could cause your system not to boot.







4-3 EasyTune 6

GIGABYTE's EasyTune 6 is a simple and easy-to-use interface that allows users to fine-tune their system settings or do overclock/overvoltage in Windows environment. The user-friendly EasyTune 6 interface also includes tabbed pages for CPU and memory information, letting users read their system-related information without the need to install additional software.

The EasyTune 6 Interface



Tabs Information

Tab	Function
 CPU	The CPU tab provides information on the installed CPU and motherboard.
 Memory	The Memory tab provides information on the installed memory module(s). You can select memory module on a specific slot to see its information.
 Tuner	<p>The Tuner tab allows you to change system clock settings and voltages.</p> <ul style="list-style-type: none"> • Quick Boost mode provides you with 3 levels of CPU frequency/base clock to choose to achieve desired system performance. <small>(Note)</small> After making changes in Quick Boost mode or clicking Default to restore to default values, be sure to restart your system for these changes to take effect. • Easy mode allows you to adjust the CPU base clock only. • Advanced mode allows you to individually change system clock settings and voltages settings using the sliders. • Save allows you to save the current settings to a new profile (.txt file). • Load allows you to load previous settings from a profile. <p>After making changes in Easy mode/Advanced mode, be sure to click Set for these changes to take effect or click Default to restore to default values.</p>
 Graphics	The Graphics tab allows you to change the core clock and memory clock for your ATI or NVIDIA graphics card.
 Smart	The Smart tab allows you to specify a C.I.A.2 level and a Smart Fan mode. Smart Fan Advance Mode allows the CPU fan speed to be changed linearly based on the CPU temperature thresholds you set.
 HW Monitor	The HW Monitor tab allows you to monitor hardware temperature, voltage and fan speed and set temperature/fan speed alarm. You can choose the alert sound from the buzzer or use your own sound file (.wav file).

(Note) Due to the hardware limitation, you must install a DDR3 1066 MHz memory module(s) (or above) to enable support for Quick Boost.



Available functions in EasyTune 6 may differ by motherboard model. Grayed-out area(s) indicates that the item is not configurable or the function is not supported.



Incorrectly doing overclock/overvoltage may result in damage to the hardware components such as CPU, chipset, and memory and reduce the useful life of these components. Before you do the overclock/overvoltage, make sure that you fully know each function of EasyTune 6, or system instability or other unexpected results may occur.

4-4 Dynamic Energy Saver™ 2

GIGABYTE Dynamic Energy Saver™ 2 (Note 1) is a revolutionary technology that delivers unparalleled power savings with a click of the button. Featuring an advanced proprietary hardware and software design, GIGABYTE Dynamic Energy Saver™ 2 is able to provide exceptional power savings and enhanced power efficiency without sacrificing computing performance.

The Dynamic Energy Saver™ 2 Interface

A. Meter Mode

In Meter Mode, GIGABYTE Dynamic Energy Saver™ 2 shows how much power they have saved in a set period of time.



Meter Mode - Button Information Table

	Button Description
1	Dynamic Energy Saver On/Off Switch (Default: Off)
2	Current CPU Power Consumption
3	Power Saving (Calculate power savings based on time)
4	Meter Time
5	Meter/Timer Reset Switch
6	Total Mode Switch
7	Meter Mode Switch
8	Dynamic Power Phase Status
9	Power Saving Status (Icons of the devices currently in power-saving mode will light on)
10	3-Level Power Saving Switch (Default: 1) (Note 2)
11	Advanced Settings
12	Close (Application will enter Stealth Mode)
13	Minimize (Application will continue to run in taskbar)
14	INFO/Help
15	Motherboard Phase LED On/Off Switch (Default: On)
16	Live Utility Update (Check for the latest utility version)

- The above data is for reference only. Actual performance may vary depending on motherboard model.
- CPU Power and Power Scores are for reference only. Actual results may vary based on testing method.

B. Total Mode

In Total Mode, users are able to see how much total power savings they have accumulated in a set period of time since activating Dynamic Energy Saver™ 2 for the first time^(Note 3).



Total Mode - Button Information Table

	Button Description
1	Dynamic Energy Saver On/Off Switch (Default: Off)
2	Current CPU Power Consumption
3	Total Power Savings (Total power saving with Dynamic Energy Saver enabled) ^(Note 4)
4	Time/Date Dynamic Energy Saver Enabled
5	Total Mode Switch
6	Meter Mode Switch
7	Dynamic Power Phase Status
8	Power Saving Status (Icons of the devices currently in power-saving mode will light on)
9	3-Level Power Saving Switch (Default: 1) ^(Note 2)
10	Advanced Settings
11	Close (Application will enter Stealth Mode)
12	Minimize (Application will continue to run in taskbar)
13	INFO/Help
14	Motherboard Phase LED On/Off Switch (Default: On)
15	Live Utility Update (Check for the latest utility version)

C. Stealth Mode

In Stealth Mode, the system continues to work with the user-defined power saving settings, even after the system is restarted. Re-enter the application only if you want to make any changes or completely close the application.

(Note 1) Before using the Dynamic Energy Saver™ 2 function, make sure the **CPU Enhanced Halt (C1E)** and **CPU EIST Function** items in the BIOS Setup program are set to **Enabled**.

(Note 2) 1: Smart FNA/CPU (default); 2: Smart FNA/CPU/VGA/HDD; 3: Smart FNA/CPU/VGA/HDD/Chipset/Memory.

(Note 3) The total amount of power saved will be recorded until re-activated when only the Dynamic Power Saver is under the enable status, and power savings meter is unable to reset to zero.

(Note 4) Dynamic Energy Saver Meter will automatically reset when the total power saving reaches 999999999 Watts.

4-5 Q-Share

Q-Share is an easy and convenient data sharing tool. After configuring your LAN connection settings and Q-Share, you are able to share your data with computers on the same network, making full use of Internet resources.



Directions for using Q-Share

After installing Q-Share from the motherboard driver disk, go to Start>All Programs>GIGABYTE>Q-Share.exe to launch the Q-Share tool. Find the **Q-Share** icon  in your taskbar and right-click on this icon to configure the data sharing settings.



Figure 1. Data Sharing Disabled



Figure 2. Data Sharing Enabled

Options Descriptions

Option	Description
Connect ...	Displays the computers with data sharing enabled
Enable Incoming Folder ...	Enables data sharing
Disable Incoming Folder ...	Disables data sharing
Open Incoming Folder : C:\Q-ShareFolder	Accesses the shared data folder
Change Incoming Folder : C:\Q-ShareFolder	Changes the data folder to be shared ^(Note)
Update Q-Share ...	Updates Q-Share online
About Q-Share ...	Displays the current Q-Share version
Exit...	Exits Q-Share

(Note) This option is available only when data sharing is NOT enabled.

4-6 Smart 6™

GIGABYTE Smart 6™ (Note 1) is designed with user-friendliness in mind, and offers a combination of 6 innovative software utilities that provide easier and smarter PC system management. Smart 6™ allows you to speed up system performance, reduce boot-up time, manage a secure platform and recover specified files easily with a click of the mouse button.



SMART QuickBoot

SMART QuickBoot speeds up the system boot-up process and shortens the waiting time for entering the operating system, delivering greater efficiency for daily use.



Instructions:

Select the **Enable** check box below the **BIOS QuickBoot** or **OS QuickBoot** item and then click **Save** to save the settings.



SMART QuickBoost

SMART QuickBoost features quick and effortless CPU overclocking for novice and experienced users alike; users simply click on one of the three levels of CPU performance enhancement, and SMART QuickBoost automatically adjusts CPU performance.

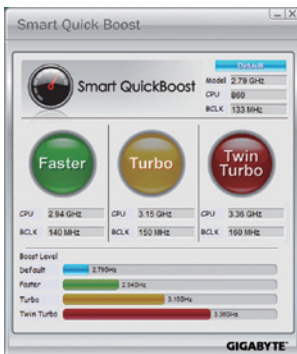

Instructions:

Select a CPU performance boost level and restart your computer for the changes to take effect.



SMART Recovery

With SMART Recovery, users can quickly create backups of changed data files ^(Note 2) or copy files from a specific backup on PATA and SATA hard drives (partitioned on NTFS file system) in Windows Vista.

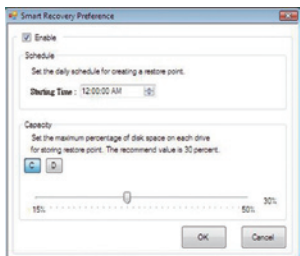

Instructions:

In the main menu, click the **Config** button to open the **Smart Recovery Preference** dialog box.

The **Smart Recovery Preference** dialog box:

Button	Function
Enable	Enables automatic daily backup ^(Note 3)
Schedule	Sets a daily backup schedule
Capacity	Sets the percentage of hard drive space used for saving backups ^(Note 4)



- The hard drive must have more than 1 GB of capacity.
- Each partition can accommodate up to 64 backups (the actual limit depends on the size of each partition). When this limit is reached, the oldest backup will be overwritten.

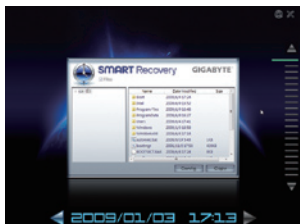

Instructions for copying files/folders from a backup:

To browse through your backups made at different time, select a backup time using the time bar on the right or at the bottom of the screen. If you want to copy back a file/folder, select the file/folder you wish to copy and click the **Copy** button.



The files/folders listed on the screen are read-only so you cannot edit their contents.



SMART DualBIOS

SMART DualBIOS is a new feature that can record personal passwords and important dates, and remind users of the dates. It stores the recorded data in the main and backup BIOS simultaneously, which can prevent loss of the data in case the system/hard drive fails.



Instructions:

Enter the Smart 6™ password to launch the SMART DualBIOS utility. In the main screen, you can set up records of personal passwords and important dates and reminders of these dates. Click **Save** to save the settings and click **Exit** to exit.



SMART Recorder

SMART Recorder monitors and records the activities in a system such as the time when the computer was turned on/off or even when large data files were moved within the hard drive or copied to an external storage device.



Instructions:

Select the **Enable** check box at the bottom of the **On/Off Recorder** or **File Monitor** tab to enable recording of system on/off time or recording of file copying. Entering the Smart 6™ password is required before you make any changes to the previous settings.



SMART TimeLock

SMART TimeLock allows users to effectively manage the use time for the computer with simple rules and options.

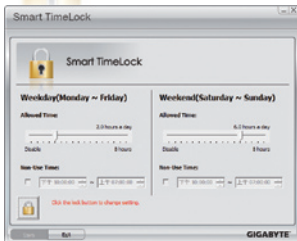

Instructions (Note 5):

Click the lock icon  on the bottom left corner and enter the Smart 6™ password. Set the allowed/disallowed use time for the computer on weekdays or on the weekend. Click **Save** to save the settings and click **Exit** to exit.



The **Smart TimeLock** dialog box:

A reminder will appear 15 minutes and 1 minute prior to the default shutdown time. When the reminder appears, you can enter the Smart 6™ password to extend the use time or click **Cancel** to close the reminder. If you respond **Cancel** to the reminder, you will be requested to enter the password to extend the use time when the shutdown time arrives, or the computer will shutdown right away.

- (Note 1) When launching Smart 6™ for the first time, the system will request you to set up a password, which allows you to activate SMART DualBIOS, SMART Recorder, or SMART TimeLock or to make any changes.
- (Note 2) The changed data refers to the data that has been modified, deleted, or newly added since the last backup.
- (Note 3) The system will make an automatic backup on changed data only once everyday. If the computer is turned on for a long time, the backup will be performed at the scheduled backup time. If the computer is turned off before the scheduled backup time, the backup will be performed on the next boot.
- (Note 4) We recommend that you preserve at least 25 percent of the hard drive space to optimize the storage space for the backups. The backups of the changed data will be stored in the original partition of the data.
- (Note 5) You can set the User Password in the system BIOS Setup program to prevent the system time being changed by other users.

4-7 Auto Green

Auto Green is an easy-to-use tool that provides users with simple options to enable system power savings via a Bluetooth cell phone. When the phone is out of the range of the computer's Bluetooth receiver, the system will enter the specified power saving mode.

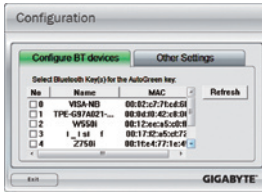

The Configuration dialog box:

First, you have to set your Bluetooth cell phone as a portable key. On the Auto Green main menu, click **Configure** and then click **Configure BT devices**. Select the Bluetooth cell phone that you want to use as the portable key^(Note 1). (If the screen doesn't display your Bluetooth cell phone, click **Refresh** to let Auto Green re-detect the device.)



Before creating a Bluetooth cell phone key, make sure your motherboard has a Bluetooth receiver and you have turned on the search and Bluetooth functions on your phone.



Configuring the Bluetooth cell phone key:

After you select a cell phone, the **Add Bluetooth Device Wizard** as shown on the left will appear. Enter a passkey (8~16 digits recommended) which will be used for pairing with the cell phone. Then enter the same passkey on your cell phone.



Configuring other Bluetooth settings:

On the **Other Settings** tab, you can set how much time it takes to scan your Bluetooth cell phone key, how many times to rescan the key to make sure it is in range of your computer, and when to turn off the hard drive if the system energy saving state lasts over the predetermined period of time. After completing the settings, click **Set** for the settings to take effect and then click **Exit** to quit.

- **Device Scan Time (sec.):**
Set the length of time Auto Green scans your Bluetooth cell phone key, ranging from 5 to 30 seconds in 5-second increment. Auto Green searches for the key based on the length of time you set.
- **Rescan Times:**
Set how many times Auto Green will rescan your Bluetooth cell phone key if it does not detect it, ranging from 2 to 5 times. Auto Green will keep rescanning according to the times you set. When the times limit is reached and your Bluetooth cell phone key is still not detected, the system will enter the selected energy saving mode.
- **Turn off HD:**
Set when to turn off the hard drive. If the system inactivity time exceeds the specified time limit, the hard drive will be turned off.



Selecting a system energy saving mode:

Depending on your needs, select a system power saving mode on the Auto Green main menu and click **Save** to save the settings.

Button	Description
Standby	Enters Power on Suspend mode
Suspend	Enters Suspend to RAM mode
Disable	Disables this function



The Bluetooth dongle included in the motherboard package^(Note 2) allows you to wake up the system from Suspend to RAM mode without the need to press the power button first.

(Note 1) If your cell phone has been configured as the Auto Green key, you'll not be able to use it to connect to other Bluetooth device(s) when Auto Green is enabled.

(Note 2) Whether the Bluetooth dongle is included depends on the motherboard models. Before installing the Bluetooth dongle, be sure to turn off other Bluetooth receiver on your computer.

4-8 eXtreme Hard Drive (X.H.D)



With GIGABYTE eXtreme Hard Drive (X.H.D)^(Note 1), users can quickly configure a RAID-ready system for RAID 0 when a new SATA drive is added. For a RAID 0 array that already exists, users also can use X.H.D to easily add a hard drive into the array to expand its capacity. All with a simple click of a button, X.H.D helps to enhance your hard drive read/write performance without the need for complex and time-consuming configurations. The following procedure details the steps to set up a RAID-ready system and configure it for RAID 0.

A. Setting Up a RAID-Ready System

Step 1: Configure the system BIOS

Enter the system BIOS Setup program, set **eXtreme Hard Drive (X.H.D)** under the **Integrated Peripherals** menu to **Enabled** to enable RAID for the Intel SATA controllers.

Step 2: Install the RAID driver and operating system

The X.H.D utility supports Windows 7/Vista/XP. Before installing the operating system, you have to load the SATA controller driver first. Without the driver, the hard drive may not be recognized during the Windows setup process. (For more details, refer to Chapter 5, "Installing the SATA RAID/AHCI Driver and Operating System.")

Step 3: Install the motherboard drivers and the X.H.D utility

After installing the operating system, insert the motherboard driver disk. You can click the Xpress Install All button to automatically install all motherboard drivers, including the X.H.D utility. Or you can go to the Application Software screen to individually install the X.H.D utility later.

B. Using GIGABYTE eXtreme Hard Drive (X.H.D)



Instructions:^(Note 2)

Before launching X.H.D, make sure the newly added hard-drive has equal or greater capacity than the RAID-ready system drive. (To add a new hard drive into a RAID 0 array that's been created earlier, make sure the new drive is greater than or equal to the biggest drive in the array.)

- Auto** **To automatically set up a RAID 0 array:**
Click **Auto** to automatically and quickly set up a RAID 0 array.
- Manual** **To manually set up a RAID array:**^(Note 3)
Click **Manual** to access the Intel Matrix Storage Console, with which you can build a RAID 0, RAID 1, or other supported RAID array depending on your needs and hardware components.
- Cancel** **Exits the X.H.D utility:**
Click **Cancel** to exit the X.H.D utility.

(Note 1) The X.H.D utility only supports the SATA controllers integrated in the Intel Chipset.

(Note 2) It is recommended that before you run the X.H.D utility, back up all of your data to avoid risk of hardware damage or loss of data.

(Note 3) If you manually build a non-RAID 0 array, you'll not be able to automatically set up a RAID 0 array later using the **Auto** function.

4-9 Teaming

Dual LAN with Teaming functionality enabled allows two single connections to act as one single connection for twice the transmission bandwidth, making data transmission more effective and also improving the quality of transmission of distant image(s). Fault tolerance on the dual LAN network prevents network downtime by transferring the workload from a failed port to a working port.



- The speed of transmission is subject to the actual network environment or status even with Teaming enabled.
- To enable Teaming or Bonding (IEEE 802.3ad Link Aggregation) feature, it is required that the connected network switch or router device supports the IEEE 802.3ad LACP standard. Please refer to your network switch or router device manual for further details.

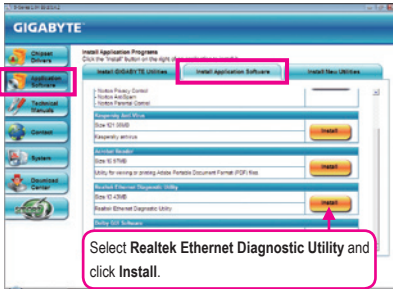

Step 1:

Insert the motherboard driver disk and select **Application Software**, **Install Application Software**. Click **Install** under **Realtek Ethernet Diagnostic Utility** for installation. Restart your system when completed.

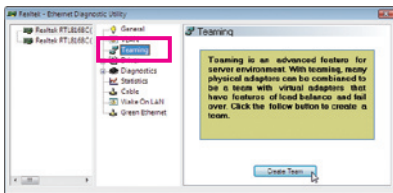

Step 3:

Choose **Teaming** and click the **Create Team** button.

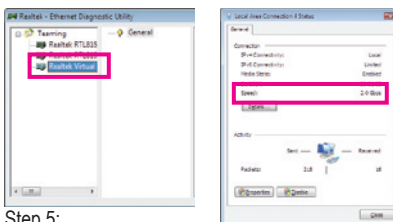

Step 5:

After you complete the setup, you will see the third virtual network interface. Go to **Local Area Connection Status** and you will see the connection speed is 2.0 Gbps.

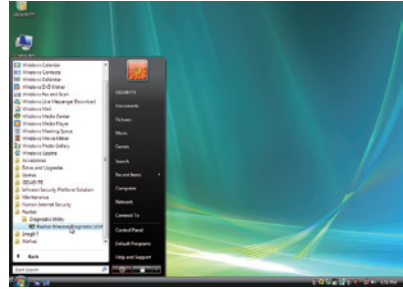

Step 2:

Click the **Start** icon. Point to **All Programs**, **Realtek**, **Diagnostic Utility**, **Realtek Ethernet Diagnostic Utility** to access the utility.

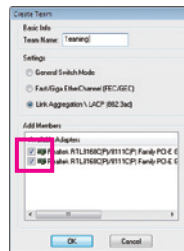

Step 4:

Give a name for the Team, e.g. Teaming, and set up the Teaming mode based on your hub's specifications. Select the check boxes for the two available adapters and click **OK**.

Removing the Existing Teaming:

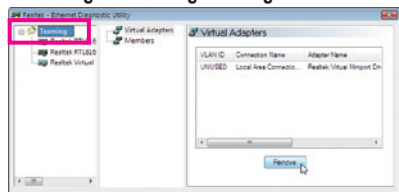

To remove the existing Teaming, click the item you created, and then click the **Remove** button.

Chapter 5 Appendix

5-1 Configuring SATA Hard Drive(s)

To configure SATA hard drive(s), follow the steps below:

- A. Install SATA hard drive(s) in your computer.
- B. Configure SATA controller mode in BIOS Setup.
- C. Configure a RAID array in RAID BIOS. ^(Note 1)
- D. Make a floppy disk containing the SATA RAID/AHCI driver for Windows XP. ^(Note 2)
- E. Install the SATA RAID/AHCI driver ^(Note 2) and operating system.

Before you begin

Please prepare:

- At least two SATA hard drives (to ensure optimal performance, it is recommended that you use two hard drives with identical model and capacity). If you do not want to create RAID, you may prepare only one hard drive.
- An empty formatted floppy disk.
- Windows Vista/XP setup disk.
- Motherboard driver disk.

5-1-1 Configuring Intel ICH10R SATA Controllers

A. Installing SATA hard drive(s) in your computer

Attach one end of the SATA signal cable to the rear of the SATA hard drive and the other end to available SATA port on the motherboard. If there is more than one SATA controller on your motherboard, refer to "Chapter 1," "Hardware Installation," to identify the SATA controller for the SATA port. (For example, on this motherboard, the SATA2_0, SATA2_1, SATA2_2, SATA2_3, SATA2_4 and SATA2_5 ports are supported by ICH10R Chipset.) Then connect the power connector from your power supply to the hard drive.

(Note 1) Skip this step if you do not want to create RAID array on the SATA controller.

(Note 2) Required when the SATA controller is set to AHCI or RAID mode.

B. Configuring SATA controller mode in BIOS Setup

Make sure to configure the SATA controller mode correctly in system BIOS Setup.

Step 1:

Turn on your computer and press <Delete> to enter BIOS Setup during the POST (Power-On Self-Test). To create RAID, set **ICH SATA Control Mode** under the **Integrated Peripherals** menu to **RAID(XHD)** (Figure 1) (**IDE** by default). If you do not want to create RAID, set this item to **IDE** or **AHCI**.

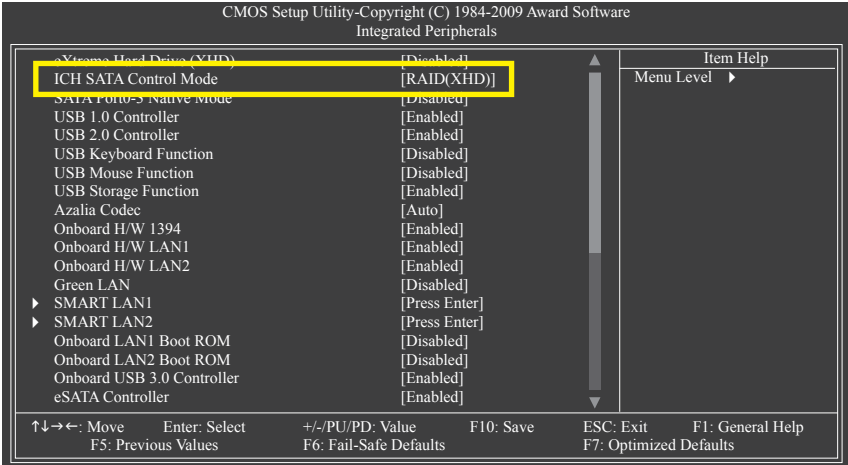

Figure 1

Step 2:

Save changes and exit BIOS Setup.



The BIOS Setup menus described in this section may differ from the exact settings for your motherboard. The actual BIOS Setup menu options you will see shall depend on the motherboard you have and the BIOS version.

C. Configuring a RAID array in RAID BIOS

Enter the RAID BIOS setup utility to configure a RAID array. Skip this step and proceed with the installation of Windows operating system for a non-RAID configuration.

Step 1:

After the POST memory test begins and before the operating system boot begins, look for a message which says "Press <Ctrl-> to enter Configuration Utility" (Figure 2). Press <Ctrl> + <I> to enter the ICH10R RAID Configuration Utility.

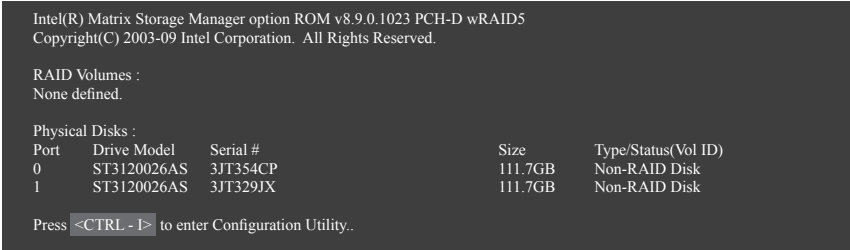

Figure 2

Step 2:

After you press <Ctrl> + <I>, the **MAIN MENU** screen will appear (Figure 3).

Create RAID Volume

If you want to create a RAID array, select **Create RAID Volume** in **MAIN MENU** and press <Enter>.

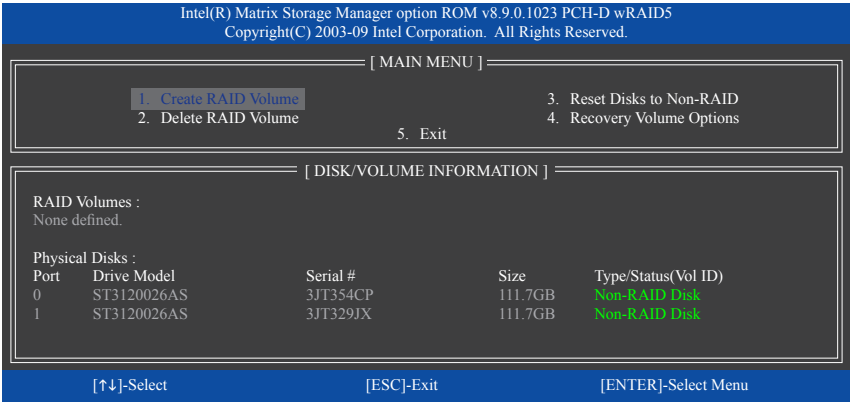

Figure 3

Step 3:

After entering the **CREATE VOLUME MENU** screen, enter a volume name with 1~16 letters (letters cannot be special characters) under the **Name** item and press <Enter>. Then, select a RAID level (Figure 4). RAID levels supported include RAID 0, RAID 1, Recovery, RAID 10, and RAID 5 (the selections available depend on the number of the hard drives being installed). Press <Enter> to proceed.

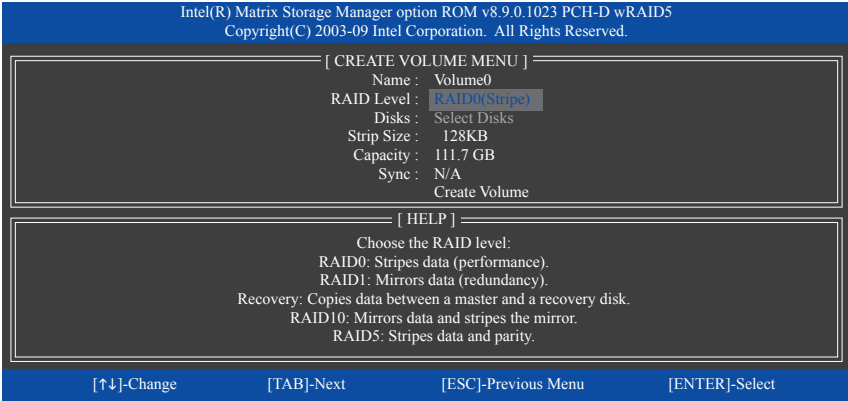

Figure 4

Step 4:

Under **Disks** item, select the hard drives to be included in the RAID array. If only two hard drives are installed, they will be automatically assigned to the array. Set the stripe block size (Figure 5) if necessary. The stripe block size can be set from 4 KB to 128 KB. Once you have selected the stripe block size, press <Enter>.

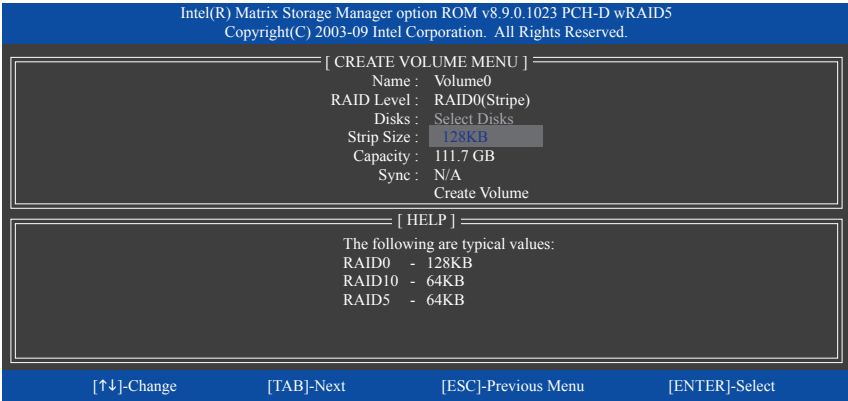

Figure 5

Step 5:

Enter the array capacity and press <Enter>. Finally press <Enter> on the **Create Volume** item to begin creating the RAID array. When prompted to confirm whether to create this volume, press <Y> to confirm or <N> to cancel (Figure 6).

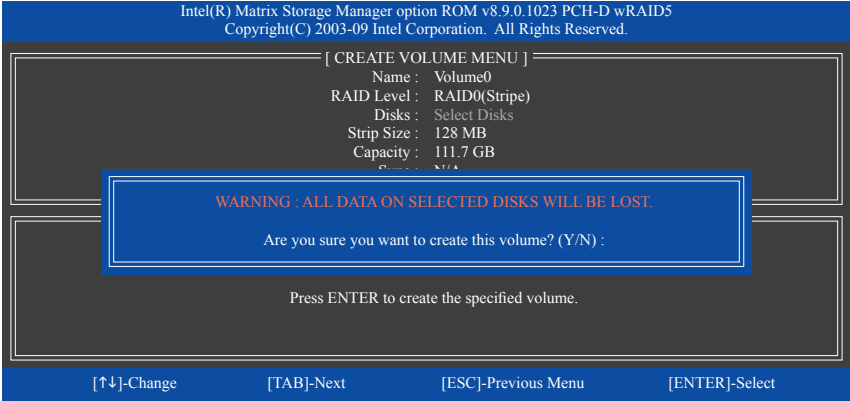

Figure 6

When completed, you can see detailed information about the RAID array in the **DISK/VOLUME INFORMATION** section, including the RAID level, stripe block size, array name, and array capacity, etc. (Figure 7)

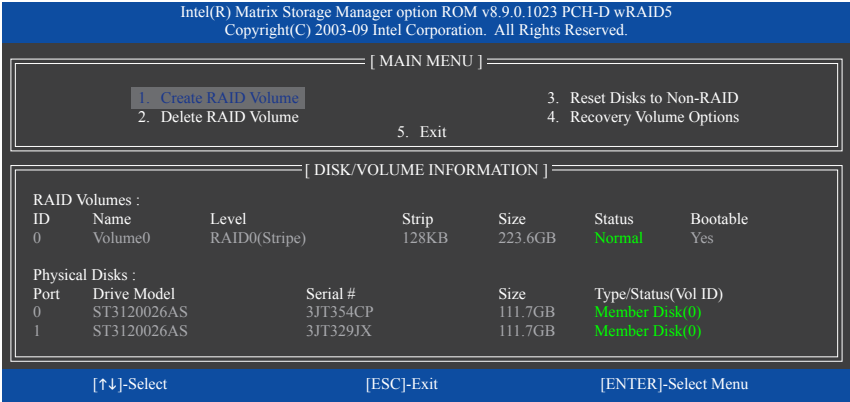

Figure 7

To exit the RAID BIOS utility, press <Esc> or select **5. Exit** in **MAIN MENU**.

Now, you can proceed to create the SATA RAID/AHCI driver diskette and install the SATA RAID/AHCI driver and operating system.

Step 3:

Press <Enter> under the **Select Disks** item. In the **SELECT DISKS** box, press <Tab> on the hard drive you want to use for the master drive and press <Space> on the hard drive you want to use for the recovery drive. (Make sure the recovery drive has equal or larger capacity than the master drive.) Then press <Enter> to confirm. (Figure 10)

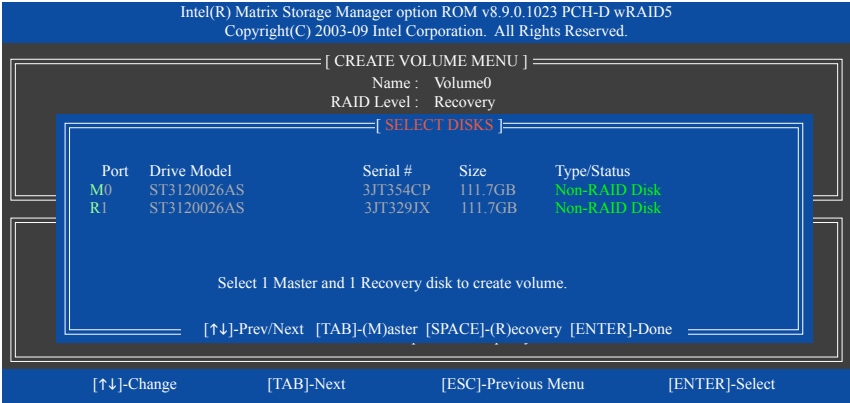

Figure 10

Step 4:

Under **Sync**, select **Continuous** or **On Request** (Figure 11). When set to **Continuous**, changes made to the data on the master drive will be automatically and continuously copied to the recovery drive when both hard drives are installed in the system. **On Request** allows users to update data from the master drive to the recovery drive manually using the **Update Volume** function of the Intel Matrix Storage Console in the operating system. **On Request** also allows users to restore the master drive to a previous state.

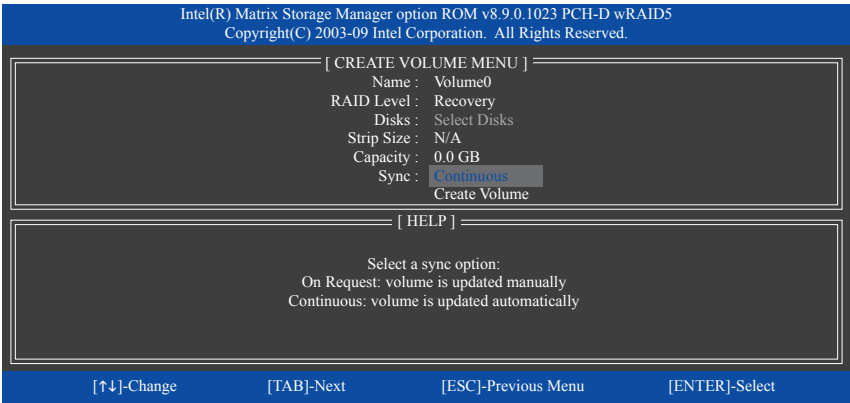

Figure 11

Step 5:

Finally press <Enter> on the **Create Volume** item to begin creating the Recovery Volume and follow the on-screen instructions to complete.

Delete RAID Volume

To delete a RAID array, select **Delete RAID Volume** in **MAIN MENU** and press <Enter>. In the **DELETE VOLUME MENU** section, use the up or down arrow key to select the array to be deleted and press <Delete>. When prompted to confirm your selection (Figure 12), press <Y> to confirm or <N> to abort.

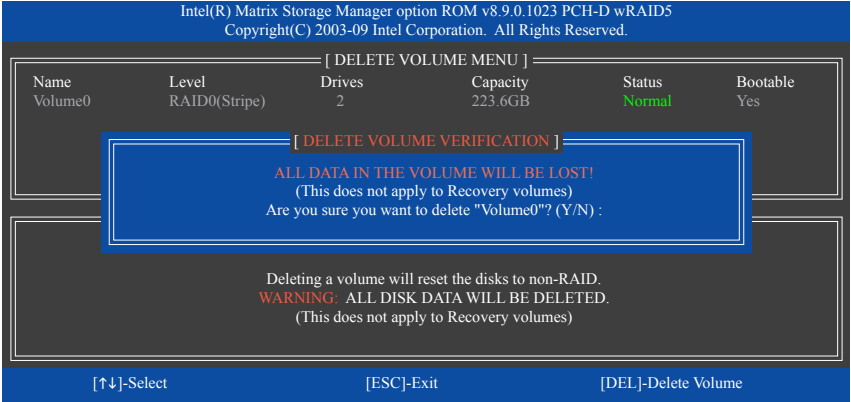

Figure 12

5-1-2 Configuring JMicron JMB362/GIGABYTE SATA2 SATA Controller

A. Installing SATA hard drive(s) in your computer

Attach one end of the SATA signal cable to the rear of the SATA hard drive and the other end to available SATA port on the motherboard. See the table below for the SATA controllers and their corresponding SATA ports. Then connect the power connector from your power supply to the hard drive.

B. Configuring SATA controller mode in BIOS Setup

Make sure to configure the SATA controller mode correctly in system BIOS Setup.

Step 1:

Turn on your computer and press <Delete> to enter BIOS Setup during the POST. In BIOS Setup, go to **Integrated Peripherals**. To enable RAID, see the table below for configuring different SATA Controllers for RAID.

Controller	Connectors	BIOS Settings
JMicron JMB362	eSATA ports	Set eSATA Controller to Enabled Set eSATA Ctrl Mode to RAID
GIGABYTE SATA2	GSATA2_8/9	Set GSATA 8_9/IDE Controller to Enabled Set GSATA 8_9/IDE Ctrl Mode to RAID/IDE

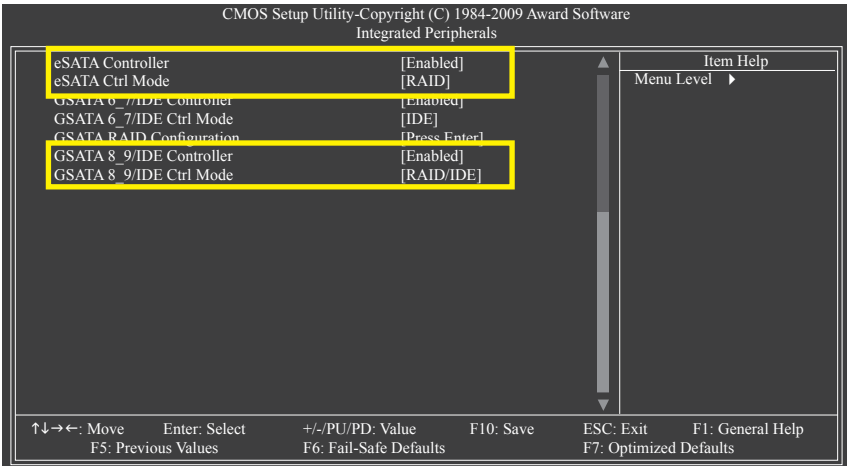

Figure 1

Step 2:

Save changes and exit BIOS Setup.



The BIOS Setup menus described in this section may differ from the exact settings for your motherboard. The actual BIOS Setup menu options you will see shall depend on the motherboard you have and the BIOS version.

C. Configuring a RAID array in RAID BIOS

Enter the RAID BIOS setup utility to configure a RAID array. Skip this step and proceed to the installation of Windows operating system for a non-RAID configuration.

After the POST memory test begins and before the operating system boot begins, look for a message which says "Press <Ctrl-G> to enter RAID Setup Utility" (Figure 2). Press <Ctrl> + <G> to enter the RAID setup utility.



Figure 2

In the main screen of the RAID setup utility (Figure 3), use the up or down arrow key to highlight through choices in the **Main Menu** block. Highlight the item that you wish to execute and press <Enter>.

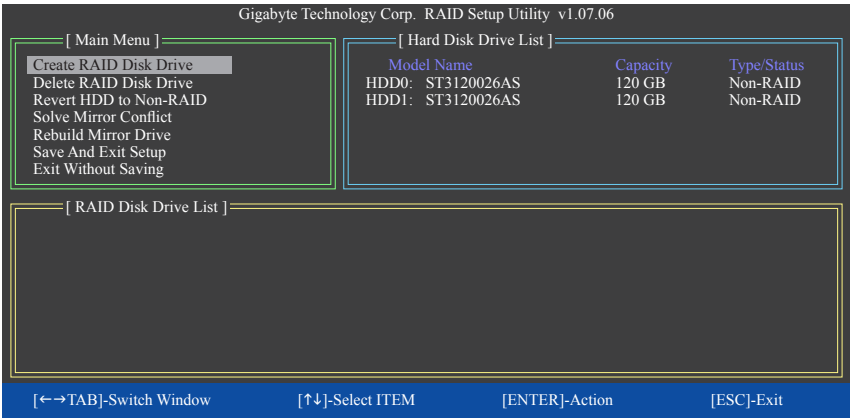

Figure 3

Note: In the main screen, you can select a hard drive in the **Hard Disk Drive List** block and press <Enter> to see detailed information about the selected hard drive.

Create a RAID Array:

In the main screen, press <Enter> on the **Create RAID Disk Drive** item. Then the **Create New RAID** screen appears (Figure 4).

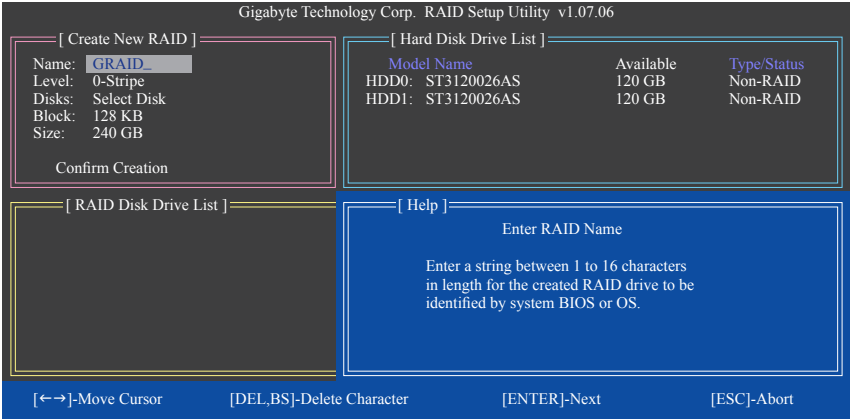

Figure 4

The **Create New RAID** block displays all the items that need to be set for creating an array (Figure 5).

Steps:

1. **Enter Array Name:** Under the **Name** item, enter an array name with 1~16 letters (letters cannot be special characters) and press <Enter>.
2. **Select RAID Mode:** Under the **Level** item, use up or down arrow key to select RAID 0 (Stripe), RAID 1 (Mirror) or JBOD (Figure 5). Then press <Enter> to move onto the next step.

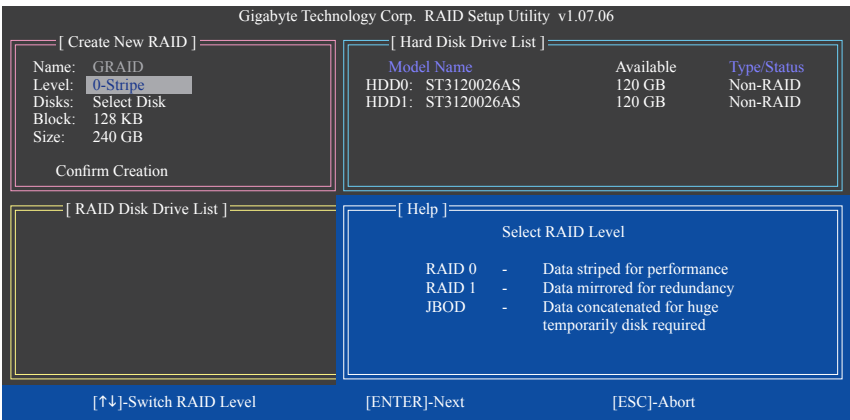

Figure 5

3. **Assign Array Disks:** After a RAID mode is selected, RAID BIOS automatically assigns the two hard drives installed as the RAID drives.
4. **Set Block Size (RAID 0 only):** Under the **Block** item, use the up or down arrow key to select the stripe block size (Figure 6), ranging from 4 KB to 128 KB. Press <Enter>.

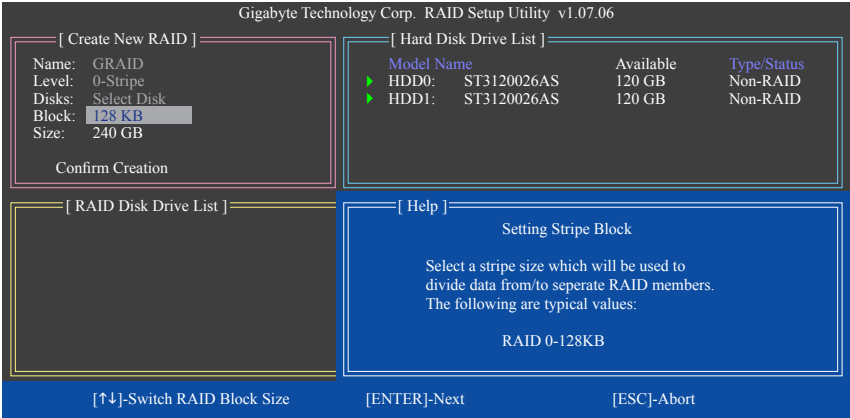

Figure 6

5. **Set Array Size:** Under the **Size** item, enter the size of the array and press <Enter>.
6. **Confirm Creation:** After all of the items above are configured, the selection bar automatically jumps to the **Confirm Creation** item. Press <Enter>. When prompted to confirm your selection (Figure 7), press <Y> to confirm or <N> to abort.

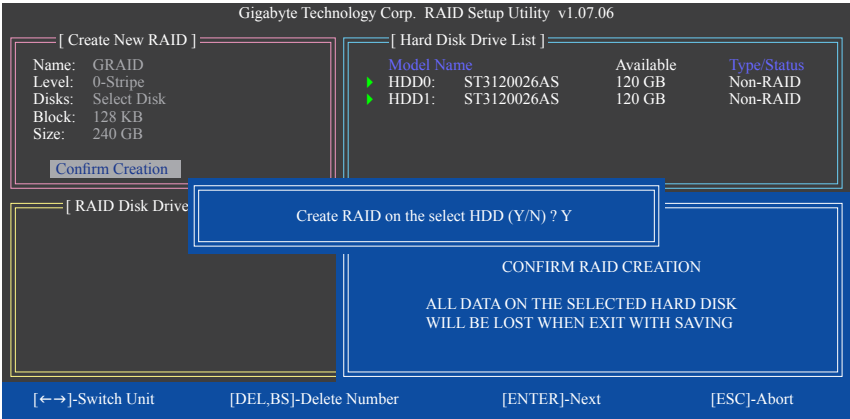

Figure 7

When finished, the new RAID array will be displayed in the **RAID Disk Drive List** block (Figure 8).

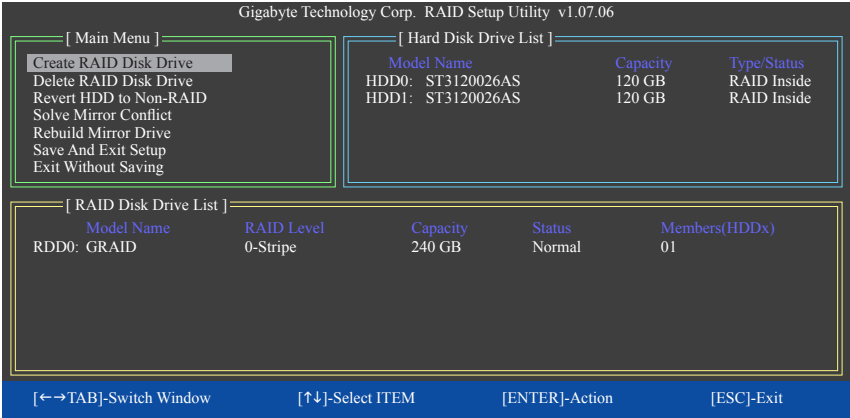

Figure 8

To check more detailed information about the array, use the <Tab> key while in the **Main Menu** block to move the selection bar to the **RAID Disk Drive List** block. Select the array and press <Enter>. A small window displaying the array information will appear in the center of the screen (Figure 9).

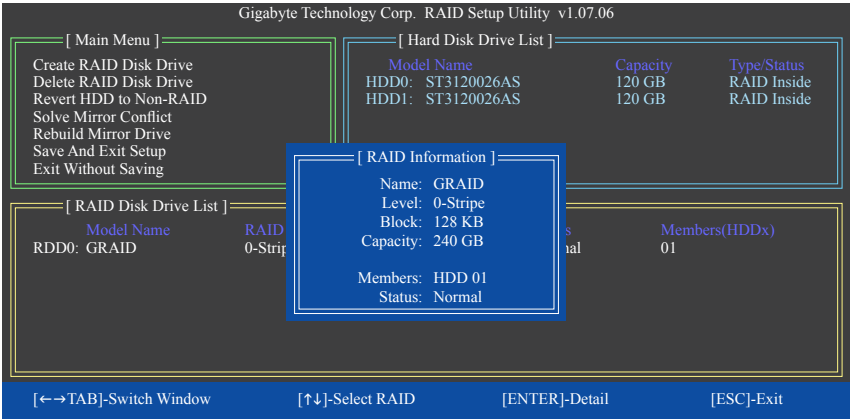

Figure 9

7. **Save and Exit Setup:** After configuring the RAID array, select the **Save And Exit Setup** item in the main screen to save your settings before exiting the RAID BIOS utility, then press <Y> (Figure 10).

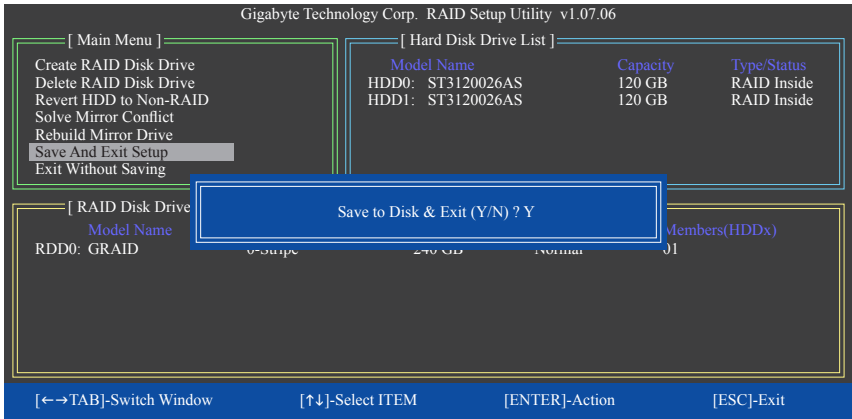

Figure 10

Now, you may proceed to create the SATA RAID/AHCI driver diskette and the installation of the SATA RAID/AHCI driver and operating system.

Delete the RAID Array:

To delete the array, select **Delete RAID Disk Drive** in the main menu and press <Enter>. The selection bar will move to the **RAID Disk Drive List** block. Press the space bar on the array to be deleted; a small triangle will appear to mark the selected array. Press <Delete>. When prompted to confirm your selection (Figure 11), press <Y> to confirm or <N> to cancel.

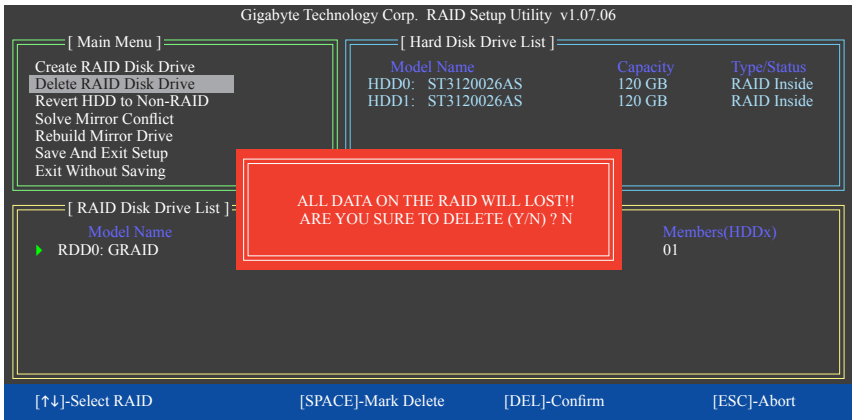

Figure 11

5-1-3 Configuring Marvell 9128 SATA Controller

A. Installing SATA hard drive(s) in your computer

Attach one end of the SATA signal cable to the rear of the SATA hard drive and the other end to available SATA port on the motherboard. The Marvell 9128 SATA controller controls the GSATA3_6/7 ports on the motherboard. Then connect the power connector from your power supply to the hard drive.

B. Configuring SATA controller and RAID mode in BIOS Setup

Make sure to configure the SATA controller mode correctly in system BIOS Setup.

Step 1:

Turn on your computer and press <Delete> to enter BIOS Setup during the POST (Power-On Self-Test). Make sure **GSATA 6_7/IDE Controller** under the **Integrated Peripherals** menu is enabled. Then set **GSATA 6_7/IDE Ctrl Mode** to **IDE** or **AHCI**, depending on your requirements (Figure 1). (In AHCI mode, installation of the SATA AHCI driver is required during Windows XP installation. Refer to section, "5-1-4" for more information.)

Step 2:

To create a RAID array, press <Enter> on the **GSATA RAID Configuration** item (Figure 1) to enter the RAID configuration menu. Skip this step if you do not want to create RAID.

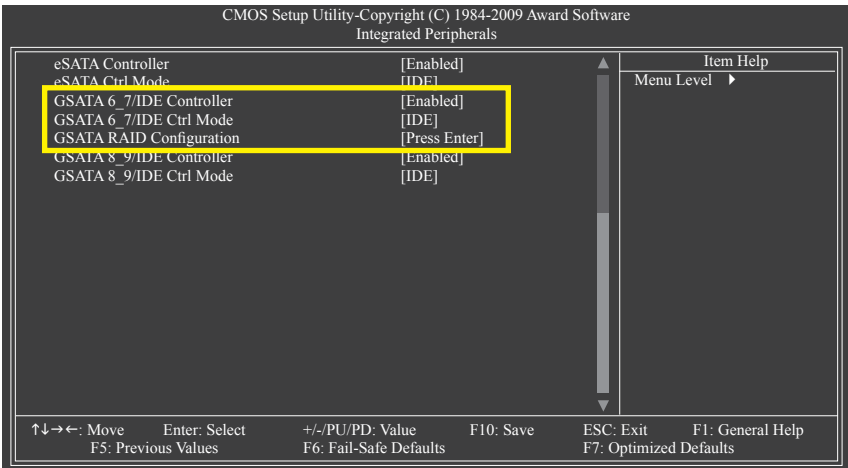

Figure 1



The BIOS Setup menus described in this section may differ from the exact settings for your motherboard. The actual BIOS Setup menu options you will see shall depend on the motherboard you have and the BIOS version.

C. Configuring a RAID array

Create a RAID Array:

Move the selection bar to **HBA 0: Marvell 0** and press <Enter>.

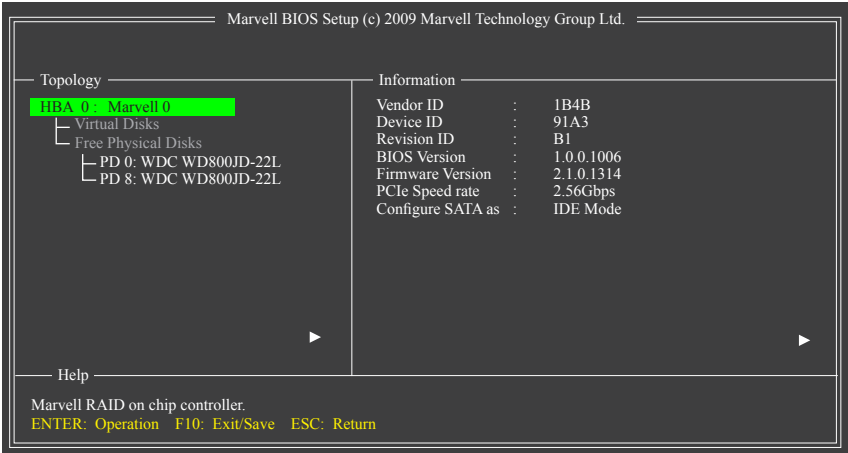

Figure 2

Under **Free Physical Disks**, use the <Space> key to select the hard drives to be included in the RAID array. The selected hard drive will be marked with an asterisk (*). After selecting the hard drives, press <Enter> to proceed (Figure 3).

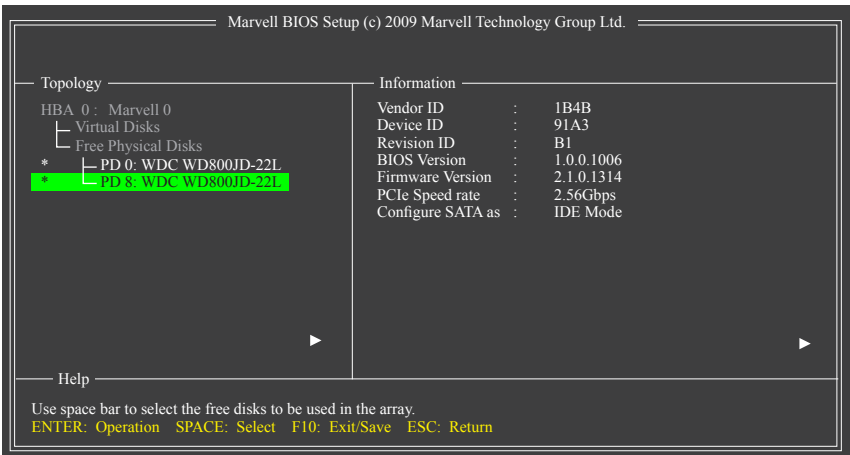

Figure 3

To further configure the RAID array, use the up or down arrow key to move the selection bar to select an item in the right block of the screen and press <Enter> (Figure 4). Set the required items in sequence and press <Enter> after each step.

Steps:

- 1. **RAID Level:** Select a RAID level. Options include RAID 0 (Stripe) and RAID 1 (Mirror).
- 2. **Stripe Size:** Select the stripe block size. Options include 32 KB and 64 KB.
- 3. **Gigabyte Rounding:** Select whether to permit the installation of a replacement drive that is smaller than the failed drive when performing a RAID 1 rebuild. Options include None, 1G, and 10G.
- 4. **Quick Init:** Select whether to quickly erase old data on the hard drives when creating the array.
- 5. **VD Name:** Enter an array name with 1~10 letters (letters cannot be special characters).

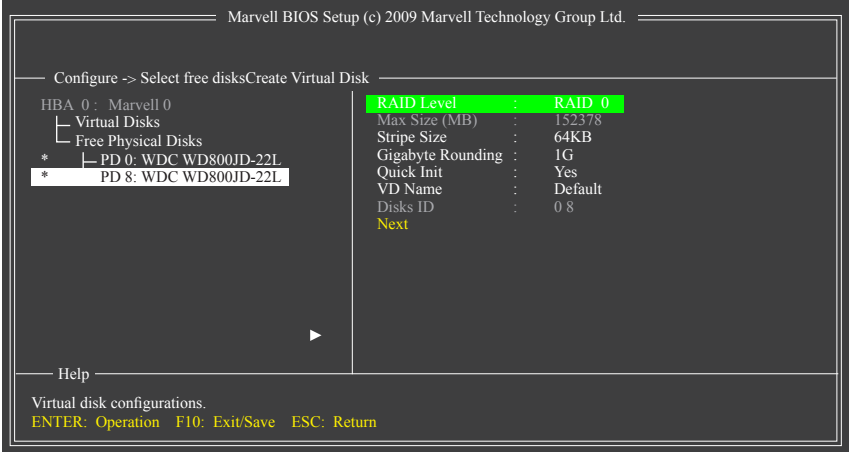

Figure 4

- 6. **Next:** After completing the settings above, move to **Next** and press <Enter> to begin creating the array. When prompted to confirm whether to create this array, press <Y> to confirm or <N> to cancel (Figure 5).

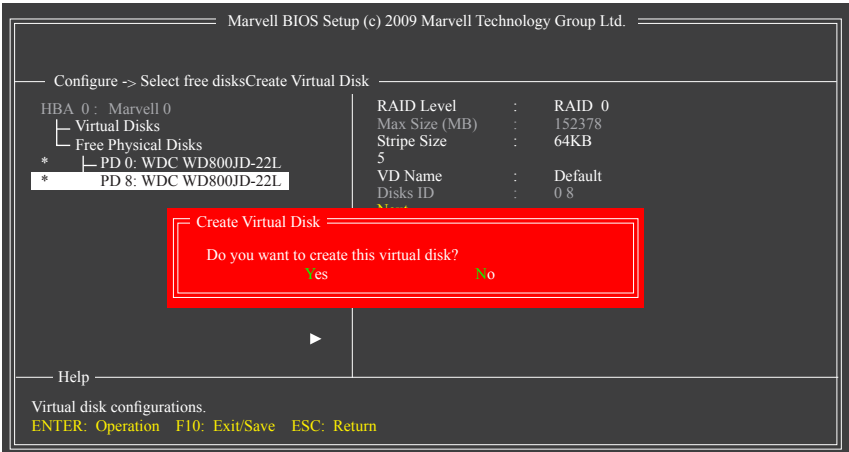

Figure 5

When completed, you can see the new array under **Topology\Virtual Disks** (Figure 6).

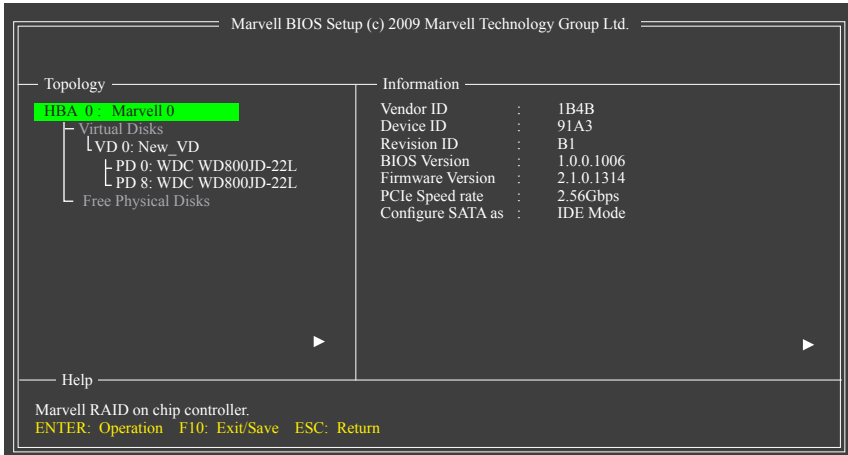

Figure 6

7. Save the Settings and Exit. After you complete the RAID configuration and before you exit the configuration screen, be sure to press <F10> in the main screen. Press <Y> to confirm or <N> to cancel (Figure 7).

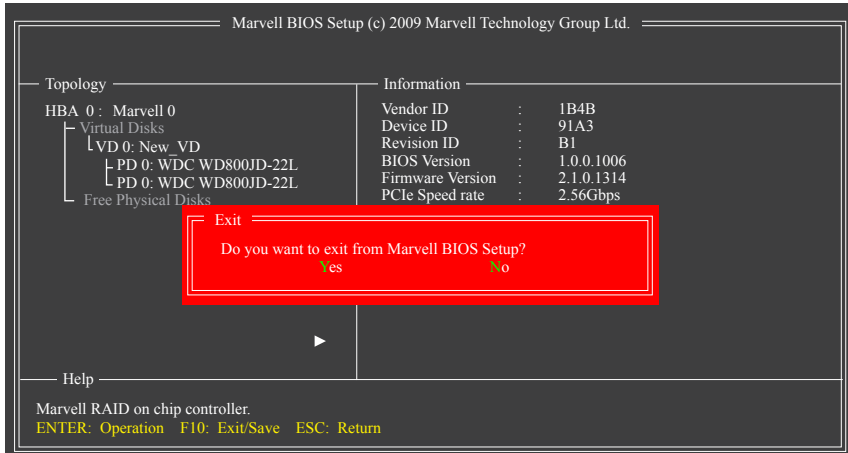

Figure 7

Now, you may proceed to create the SATA driver diskette (for AHCI mode) and the installation of the SATA driver and operating system.

Delete the RAID Array:

To deleted the existing array, select the array on the main menu (example: VD 0: New_VD) and press <Enter> to display the **Delete** option. Press <Enter>. When prompted, press <Y> to confirm or <N> to cancel (Figure 8).

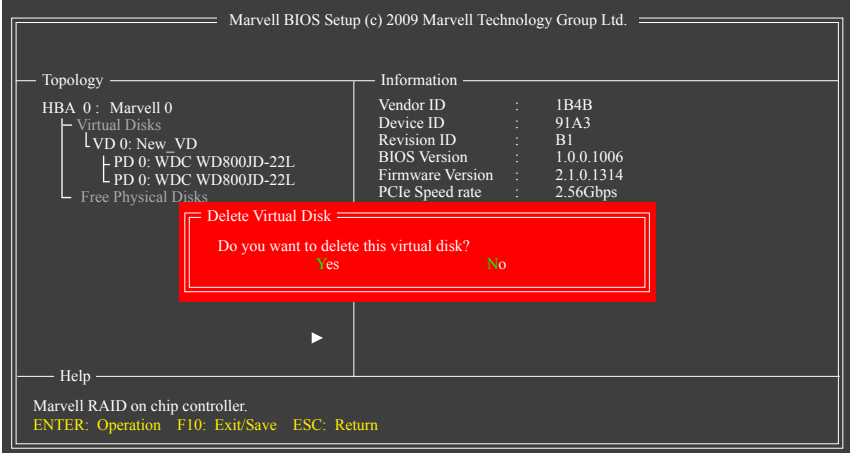

Figure 8

Use the Marvell RAID Utility in the Operating System:

With the Marvell RAID utility, you can set up an array or view the current array status in the operating system. To install the utility, insert the motherboard driver disk, then go to **Application Software\Install GIGABYTE Utilities** and select **Marvell Raid Utility** to install. Note: After the installation, you must login the utility with the same account name and password that you use to login the operating system. If you did not set the account password before, click **Login** to enter the Marvell RAID Utility directly.

5-1-4 Making a SATA RAID/AHCI Driver Diskette (Required for AHCI and RAID Mode)

To successfully install operating system onto SATA hard drive(s) that is/are configured to RAID/AHCI mode, you need to install the SATA controller driver during the OS installation. Without the driver, the hard drive may not be recognized during the Windows setup process. First of all, copy the driver for the SATA controller from the motherboard driver disk to a floppy disk. For installing Windows Vista, you also can copy the SATA controller driver from the motherboard driver disk to a USB flash drive. See the instructions below about how to copy the driver in MS-DOS and Windows mode.

In MS-DOS mode:

Prepare a startup disk that has CD-ROM support and a blank formatted floppy disk.

Steps:

- 1: Boot from the startup disk.
- 2: Remove the startup disk and insert the prepared floppy disk and the motherboard driver disk (here we assume that the drive letter for your optical drive is D:\).
- 3: At the A:\> prompt, type the following command. Press <Enter> after the command:
 - For the Intel ICH10R, type (Figure 1): (Note 1)
A:\>copy d:\bootdrv\imsm\32bit*.*
 - For the JMicron JMB362/GIGABYTE SATA2, type (Figure 2): (Note 1)
A:\>copy d:\bootdrv\gsata\32bit*.*
 - For the Marvell 9128, type (Figure 3): (Note 2)
A:\>copy d:\bootdrv\Marvell\win32*.*

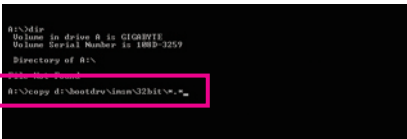

```
A:\>dir
A:\>cd d:\bootdrv\imsm\32bit
A:\>copy *.*
A:\>
```

Figure 1



```
A:\>dir
A:\>cd d:\bootdrv\gsata\32bit
A:\>copy *.*
A:\>
```

Figure 2

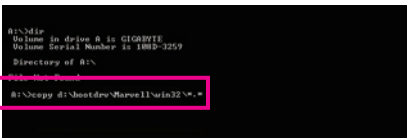

```
A:\>dir
A:\>cd d:\bootdrv\Marvell\win32
A:\>copy *.*
A:\>
```

Figure 3

(Note 1) Change the directory from `\32bit` to `\64bit` for copying the Windows 64-bit driver.

(Note 2) Change the directory from `\win32` to `\win64` for copying the Windows 64-bit driver.

In Windows mode:

Steps:

- 1: Use an alternative system and insert the motherboard driver disk.
- 2: From your optical drive folder, double click the **Menu.exe** file in the **BootDrv** folder (Figure 4). A Command Prompt window will open similar to that in Figure 5.
- 3: Insert the blank formatted disk. Depending on the operating system to be installed, select the controller driver by pressing the corresponding letter from the menu and press <Enter>. For example, from the menu in Figure 5,
 - For the Intel ICH10R, select **1) Intel Matrix Storage driver for 32bit system** for Windows XP operating system.
 - For the JMicron JMB362, select **3) GIGABYTE GSATA driver for 32bit system** for Windows 32-bit operating system.
 - For the Marvell 9128 , select **5) Marvell AHCI driver for 32bit system** for Windows 32-bit operating system (Windows XP only).

Your system will then automatically copy the driver files to the floppy disk. Press any key to exit when finished.

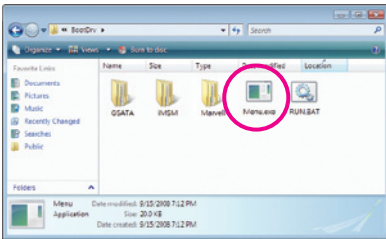

Figure 4

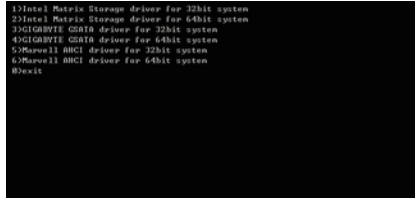

Figure 5

5-1-5 Installing the SATA RAID/AHCI Driver and Operating System

With the SATA RAID/AHCI driver diskette and correct BIOS settings, you are ready to install Windows Vista/XP onto your hard drive(s). The followings are examples of Windows XP and Vista installation.

A. Installing Windows XP

Step 1:

Restart your system to boot from the Windows XP setup disk and press <F6> as soon as you see the message "Press F6 if you need to install a 3rd party SCSI or RAID driver" (Figure 1). A screen will then appear asking you to specify additional device.

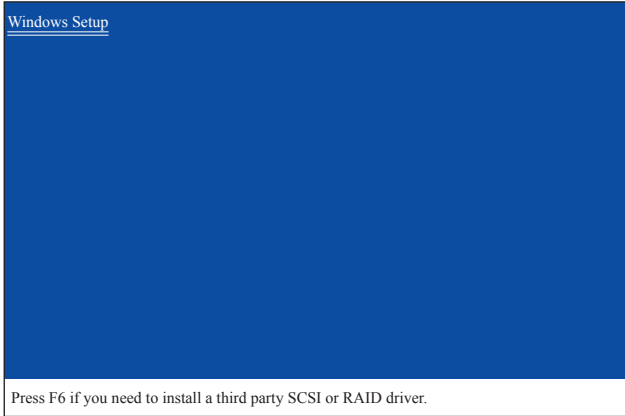

Figure 1

Step 2:

For the Intel ICH10R:

Insert the floppy disk containing the SATA RAID/AHCI driver and press <S>. Then a controller menu similar to Figure 2 below will appear. Select **Intel(R) ICH8R/ICH9R/ICH10R/DO/PCH SATA RAID Controller** and press <Enter>.

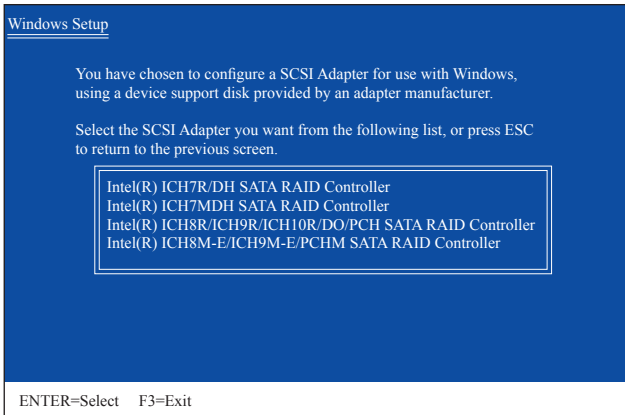

Figure 2

Step 3:

On the next screen, press <Enter> to continue the driver installation. After the driver installation, you can proceed with the Windows XP installation.

For the JMicron JMB362/GIGABYTE SATA2:

Insert the floppy disk containing the SATA RAID/AHCI driver and press <S>. Then a controller menu similar to Figure 3 below will appear. Select **RAID/AHCI Driver for GIGABYTE GBB36X Controller (x32)** and press <Enter>.

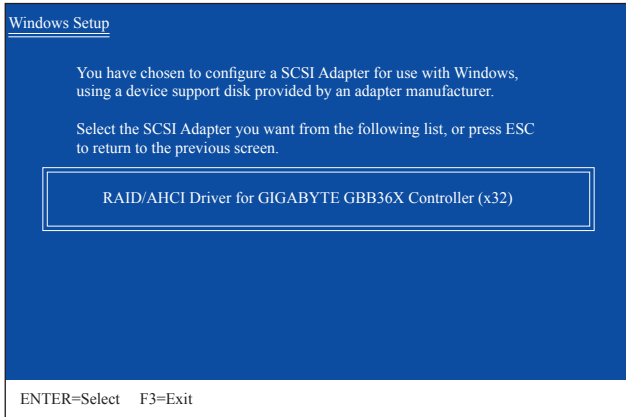

Figure 3

For the Marvell 9128:

Insert the floppy disk containing the SATA AHCI driver and press <S>. The screen will display two drivers, both of which need to be installed (Figure 4). First select **Marvell shared library (install first)** and press <Enter>. On the next screen, press <S> to return to the screen in Figure 4. Then select **Marvell 91xx SATA Controller 32bit Driver** and press <Enter>. When both of the two drivers appear on the confirmation screen, press <Enter> to continue the driver installation.

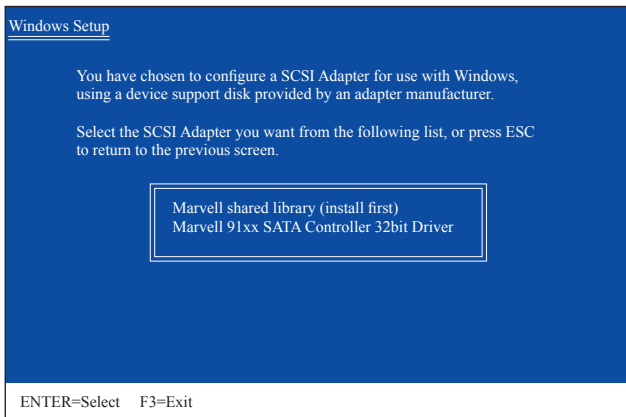

Figure 4

Step 3:

On the next screen, press <Enter> to continue the driver installation. After the driver installation, you can proceed with the Windows XP installation.

B. Installing Windows Vista

The procedure below assumes that only one RAID array exists in your system. Note: You are not required to load the SATA AHCI driver first when installing Windows Vista onto the RAID drives attached to the Marvell 9128 controller.

For the Intel ICH10R:

Step 1:

Restart your system to boot from the Windows Vista setup disk and perform standard OS installation steps. When a screen similar to that below appears (RAID hard drive will not be detected at this stage), select **Load Driver** (Figure 5).

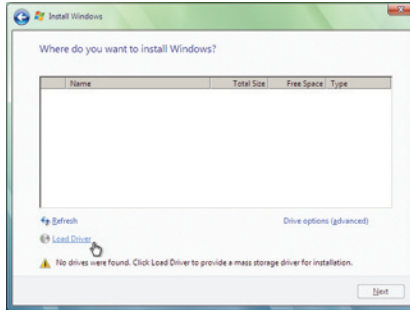

Figure 5

Step 2:

Insert the motherboard driver disk (Method A) or the floppy disk/USB flash drive that contains the driver (Method B), then specify the location of the driver (Figure 5). Note: For users using a SATA optical drive, be sure to copy the driver files from the motherboard driver disk to a USB flash drive before installing Windows Vista (go to the **BootDrv** folder and save the whole **iMSM** folder to the USB flash drive). Then use Method B to load the driver.

Method A:

Insert the motherboard driver disk into your system and browse to the following directory:

\\BootDrv\iMSM\32Bit

For Windows Vista 64-bit, browse to the **64Bit** folder.

Method B:

Insert the USB flash drive containing the driver files and browse to **\\iMSM\32Bit** (for Windows Vista 32-bit) or **\\iMSM\64Bit** (for Windows Vista 64-bit).

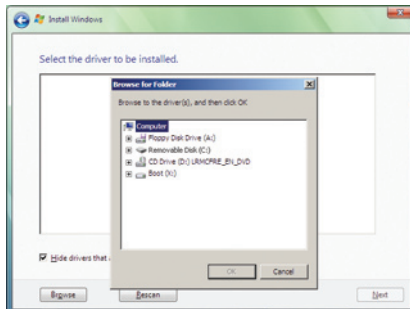

Figure 6

Step 3:

When a screen as shown in Figure 7 appears, select **Intel(R) ICH8R/ICH9R/ICH10R/DO/PCH SATA RAID Controller (A:\IaStor.inf)** and click **Next**.

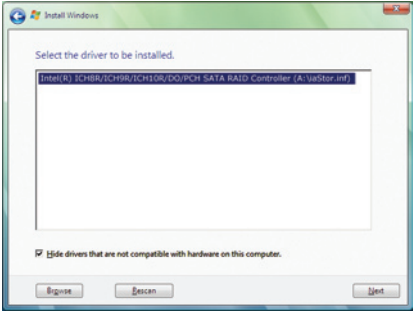

Figure 7

Step 4:

After the driver is loaded, select the RAID/AHCI drive(s) where you want to install the operating system and then click **Next** to continue the OS installation (Figure 8).

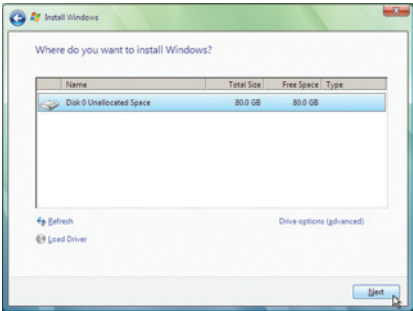

Figure 8



The install menus described in this chapter are for reference only and may differ by driver version.

For the JMicron JMB362/GIGABYTE SATA2:

Step 1:

Restart your system to boot from the Windows Vista setup disk and perform standard OS installation steps. When a screen similar to that below appears (RAID/AHCI hard drive(s) will not be detected at this stage), select **Load Driver** (Figure 9).

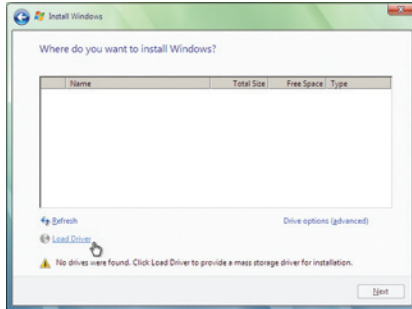

Figure 9

Step 2:

Insert the motherboard driver disk (Method A) or the floppy disk/USB flash drive that contains the SATA RAID/AHCI driver (Method B), then specify the location of the driver (Figure 10). Note: For users using a SATA optical drive, be sure to copy the driver files from the motherboard driver disk to a USB flash drive before installing Windows Vista (go to the **BootDrv** folder and save the whole **GSATA** folder to the USB flash drive). Then use Method B to load the driver.

Method A:

Insert the motherboard driver disk into your system and browse to the following directory:

\\BootDrv\\GSATA\\32Bit

For Windows Vista 64-bit, browse to the **64Bit** folder.

Method B:

Insert the USB flash drive containing the driver files and browse to **\\GSATA\\32Bit** (for Windows Vista 32-bit) or **\\GSATA\\64Bit** (for Windows Vista 64-bit).

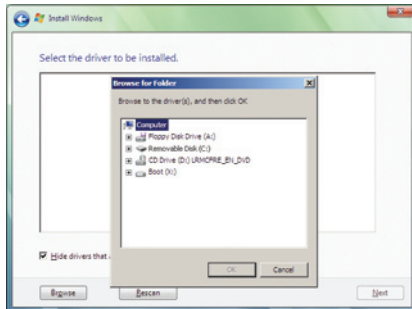

Figure 10

Step 3:

When a screen as shown in Figure 11 appears, select **GIGABYTE GBB36X Controller** and click **Next**.

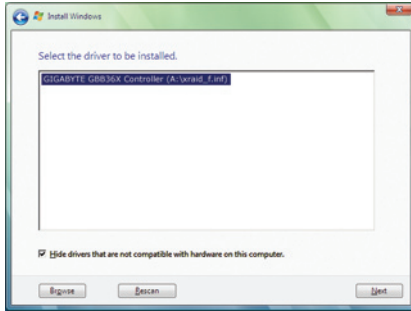

Figure 11

Step 4:

After the driver is loaded, select the RAID/AHCI drive(s) where you want to install the operating system and then click **Next** to continue the OS installation (Figure 12).

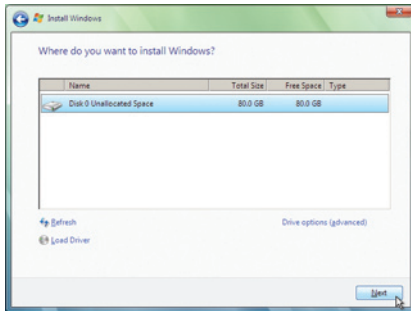

Figure 12



The install menus described in this chapter are for reference only and may differ by driver version.

C. Rebuilding an Array

Rebuilding is the process of restoring data to a hard drive from other drives in the array. Rebuilding applies only to fault-tolerant arrays such as RAID 1, RAID 5 or RAID 10 arrays. The procedures below assume a new drive is added to replace a failed drive to rebuild a RAID 1 array. (Note: The new drive must have equal or greater capacity than the old one.)

For the Intel ICH10R:

Turn off your computer and replace the failed hard drive with a new one. Restart your computer.

- **Enabling Automatic Rebuild**

Step 1:

When the message "Press <Ctrl-I> to enter Configuration Utility" appears, press <Ctrl> + <I> to enter the RAID Configuration Utility. The following screen appears after you enter the RAID Configuration Utility.

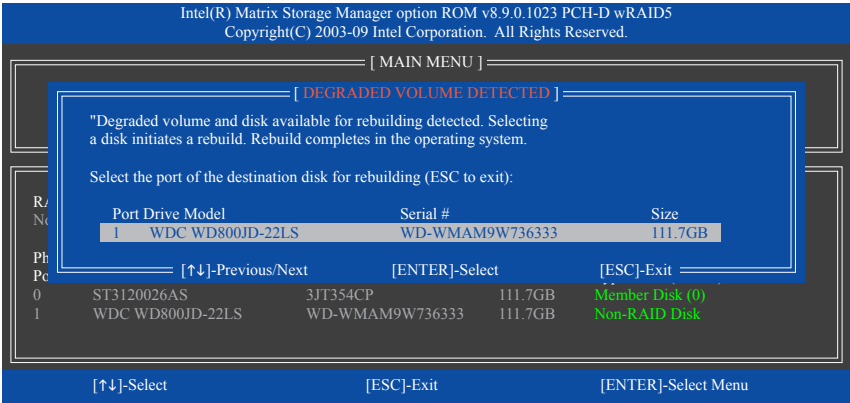

Step 2:

Select the new hard drive to add into the array to be rebuilt and press <Enter>. The following screen appears, indicating that an automatic rebuild will be performed after you enter the operating system (look for the **Intel Storage Console** icon  in the notification area, which will show that a RAID volume is being rebuilt). If you do not enable automatic rebuild on this stage, you have to manually rebuild the array in the operating system (see the next page for more details).

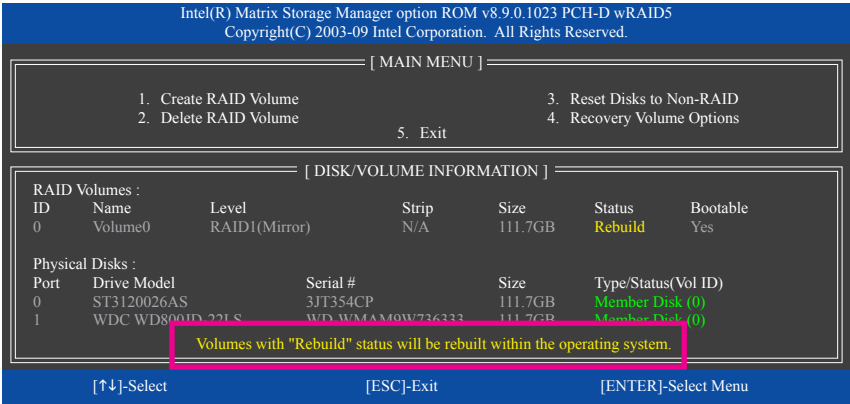

- **Performing the Rebuild in the Operating System**

While in the operating system, make sure the chipset driver has been installed from the motherboard driver disk. Then launch the Intel Matrix Storage Console from **All Programs** in the **Start** menu.

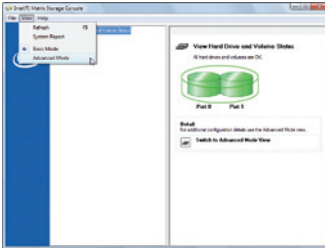

Step 1:

On the **View** menu of the Intel Matrix Storage Console, select **Advanced Mode** for a more detailed view of the storage device information.

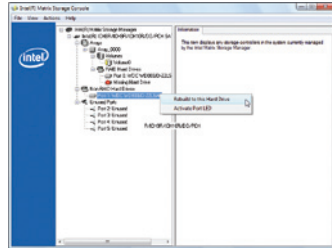

Step 2:

The new hard drive appears under **Non-RAID Hard Drive**. Right-click on the new hard drive and select **Rebuild to this Hard Drive**.



Step 3:

Click **Next** when the **Rebuild RAID Volume Wizard** appears. Follow the on-screen instructions to proceed.

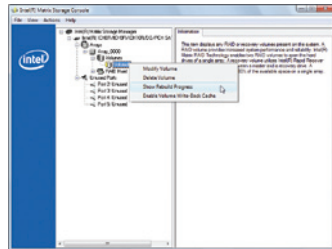

Step 4:

To check the rebuild status during the rebuild process, right-click on the rebuild volume and select **Show Rebuild Progress**.

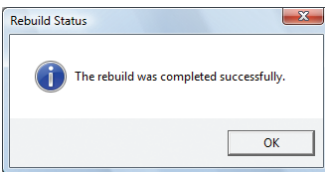

Step 5:

When the message "The rebuild was completed successfully," appears, click **OK** to complete.

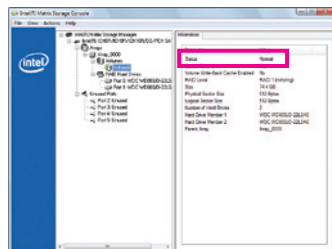

Step 6:

After the RAID 1 volume rebuilding, click the volume and its status in the information pane will display as **Normal**.

- **Restoring the Master Drive to a Previous State (for Recovery Volume only)**

When two hard drives are set to Recovery Volume in Update on Request mode, you can restore the master drive data to the last backup state when needed. For example, in case the master drive detects a virus, you can restore the recovery drive data to the master drive.

Step 1:

Select **4. Recovery Volume Options** in the **MAIN MENU** of the ICH10R RAID Configuration Utility. On the **RECOVERY OPTIONS** menu, select **Enable Only Recovery Disk** to show the recovery drive in the operating system. Follow the on-screen instructions to complete and exit the RAID Configuration Utility.

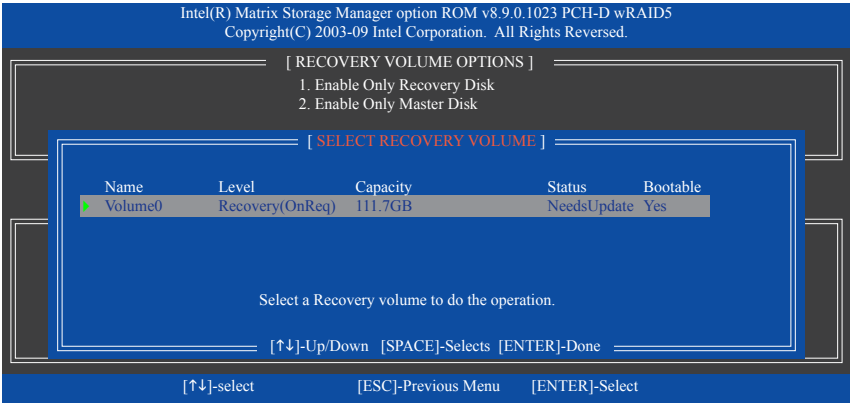

Step 2:

Enter the operating system, launch the Intel Matrix Storage Console from **All Programs** in the **Start** menu, and select **Advanced Mode**. Right-click on the recovery volume and select **Recover Data to Master**.

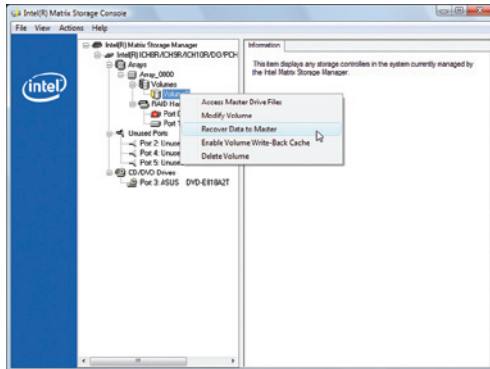

Step 3:

To check the recovery status, right-click on the recovery volume and select **Show Recovery Progress**. When a dialog box indicating that the recovery is completed appears, click **OK** to complete.

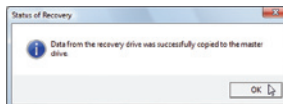

For the JMicron JMB362/GIGABYTE SATA2:

Turn off your computer and replace the failed hard drive with a new one. Use either the RAID setup utility or the GIGABYTE RAID CONFIGURER utility in the operating system to perform the rebuild.

- **Rebuilding with the RAID setup utility**

Step 1:

When the message "Press <Ctrl-G> to enter RAID Setup Utility" appears, press <Ctrl> + <G> to enter the utility. In the **Main Menu** block, select **Rebuild Mirror Drive** and press <Enter>. The selection bar will move to the degraded array. Press <Enter> again.

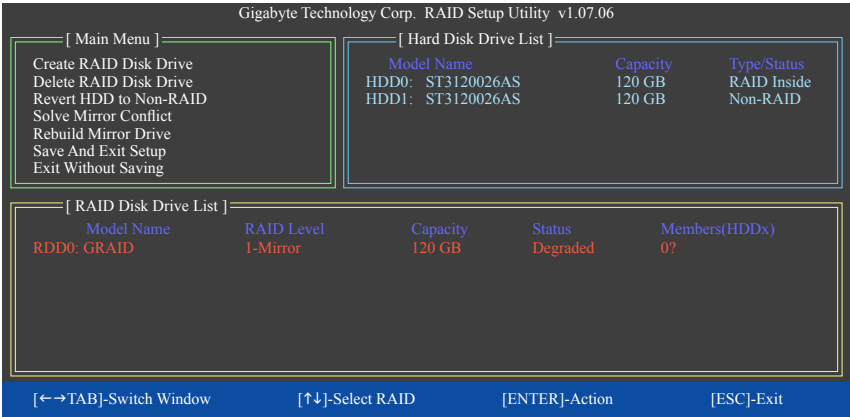

Step 2:

The selection bar will then move to new hard drive in the **Hard Disk Drive List** block. Press <Enter> to start the RAID rebuilding process. The rebuilding progress is displayed at the bottom of the screen. When done, the status of the array will display as **Normal**.

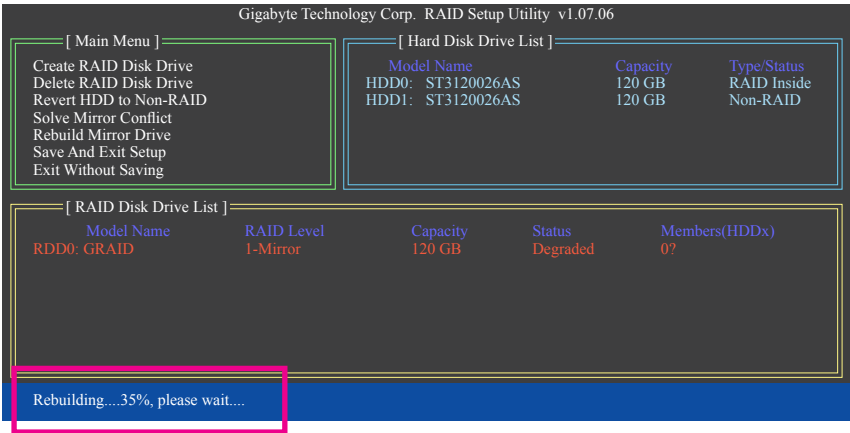

- **Rebuilding in the operating system**

Make sure the JMicron JMB362/GIGABYTE SATA2 SATA controller driver has been installed from the motherboard driver disk. Launch the GIGABYTE RAID CONFIGURER from **All Programs** in the **Start** menu.

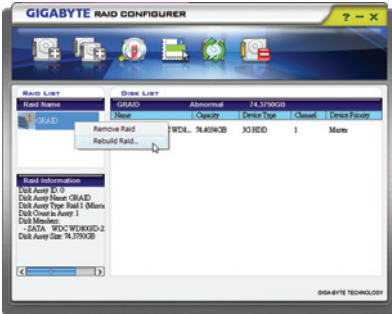

Step 1:

In the GIGABYTE RAID CONFIGURER screen, right-click on the array to be rebuilt in the **RAID LIST** block. Select **Rebuild Raid**. (Or click the **Rebuild** icon  in the tool bar.)



Step 2:

When the Rebuilding RAID Wizard appears, click **Next**.

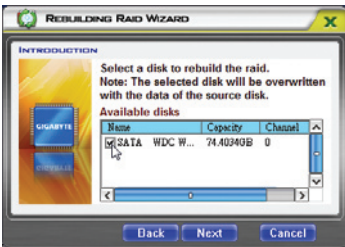

Step 3:

Select a drive to rebuild the array and click **Next**.



Step 4:

Click **Finish** to start the RAID rebuilding process.



Step 5:

The rebuilding progress is displayed at the bottom of the screen.

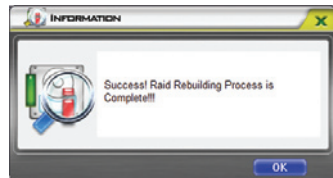

Step 6:

When finished, restart your system.

For the Marvell 9128:

Turn off your computer and replace the failed hard drive with a new one. Please note to perform the rebuild, you must enter the **GSATA RAID Configuration** menu in BIOS Setup.

Step 1:

After the system starts, enter the BIOS Setup program and go to **Integrated Peripherals**. Press <Enter> on **GSATA RAID Configuration** to access the RAID configuration menu. Move the selection bar to the array to be rebuilt (for example, VD 0: New_VD) and press <Enter> and then select **Rebuild**. Press <Enter> again.

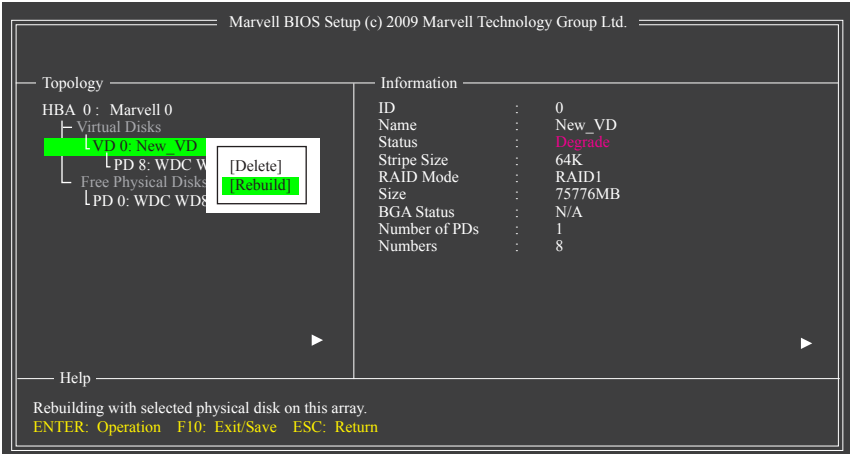

Step 2:

The selection bar will move to the new drive. Press the <Space> key to select it and then press <Enter>. When prompted to confirm, press <Y> to begin the rebuild or <N> to cancel.

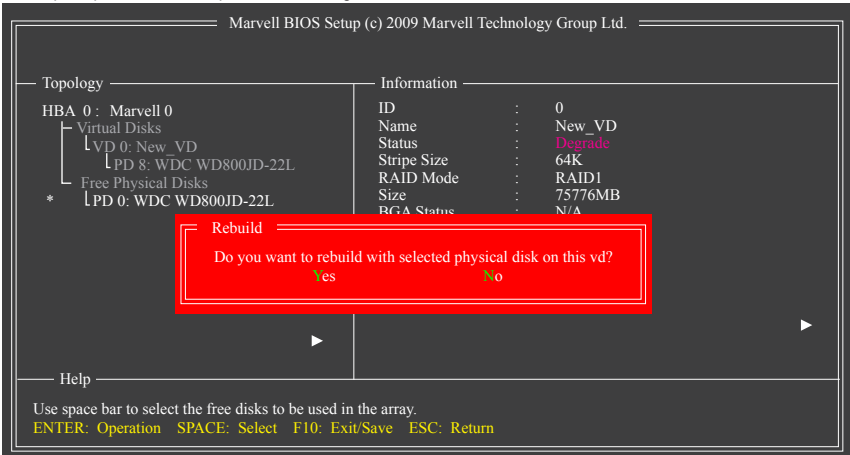

Step 3:

The **BGA Rebuild** item in the **Information** block will display the current rebuild progress. After the rebuild is complete, the **Status** will display as **Functional**. Please note the rebuild will be stopped if you exit the rebuild screen before the rebuild is complete.

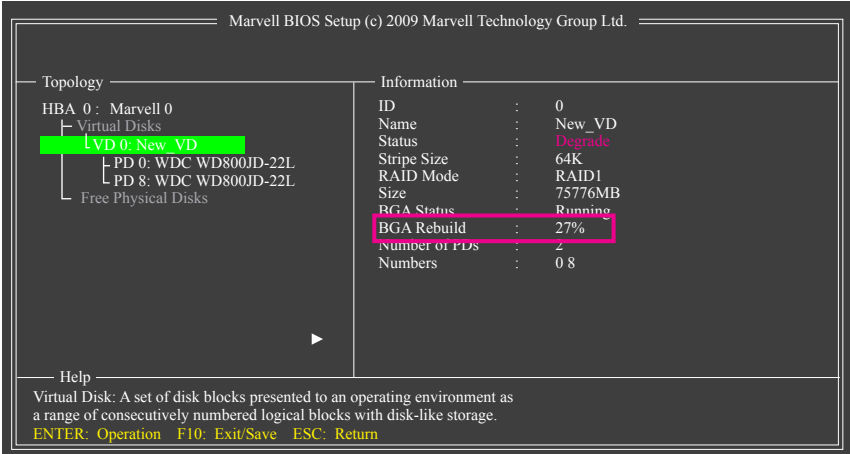

Resume the Stopped Rebuild Process

To resume the stopped rebuild process, enter the **GSATA RAID Configuration** menu in BIOS Setup again. Move the selection bar to the array to be rebuilt (for example, VD 0: New_VD). Press <Enter> on this array and select **Resume**. Press <Enter> again to continue the rebuild process. Note that the percentage of the last rebuild progress will be rounded down to the nearest multiple of 10 percent (as shown in the **BGA Rebuild** item). For example, if you stopped the rebuild at 27%, the rebuild will continue at 20%.

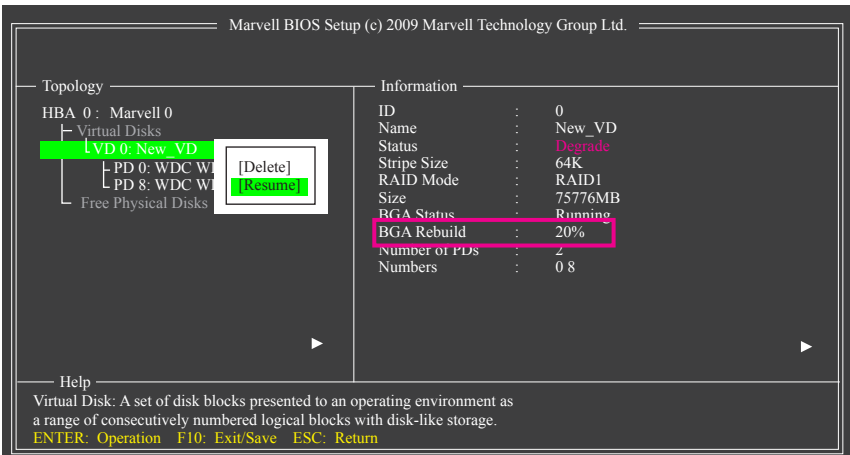

5-2 Configuring Audio Input and Output

5-2-1 Configuring 2/4/5.1/7.1-Channel Audio

The motherboard provides six audio jacks on the back panel which support 2/4/5.1/7.1-channel ^(Note) audio. The picture to the right shows the default audio jack assignments.



The integrated HD (High Definition) audio provides jack retasking capability that allows the user to change the function for each jack through the audio driver.

For example, in a 4-channel audio configuration, if a Side speaker is plugged into the default Center/Subwoofer speaker out jack, you can retask the Center/Subwoofer speaker out jack to be Side speaker out.



- To install a microphone, connect your microphone to the Mic in jack and manually configure the jack for microphone functionality.
- Audio signals will be present on both of the front and back panel audio connections simultaneously. If you want to mute the back panel audio (only supported when using an HD front panel audio module), refer to instructions on the next page.

High Definition Audio (HD Audio)

HD Audio includes multiple high quality digital-to-analog converters (DACs) that support 44.1KHz/48KHz/96KHz/192KHz sampling rate. HD Audio features multistreaming capabilities that allow multiple audio streams (in and out) to be simultaneously processed. For example, users can listen to MP3 music, have an Internet chat, make a telephone call over the Internet, and etc. all at the same time.

A. Configuring Speakers

(The following instructions use Windows Vista as the example operating system.)

Step 1:

After installing the audio driver, the **HD Audio Manager** icon  will appear in the notification area. Double-click the icon to access the **HD Audio Manager**.



(Note) 2/4/5.1/7.1-Channel Audio Configurations:

Refer to the following for multi-channel speaker configurations.

- 2-channel audio: Headphone or Line out.
- 4-channel audio: Front speaker out and Side speaker out.
- 5.1-channel audio: Front speaker out, Side speaker out, and Center/Subwoofer speaker out.
- 7.1-channel audio: Front speaker out, Rear speaker out, Center/Subwoofer speaker out, and Side speaker out.

Step 2:

Connect an audio device to an audio jack. The **The current connected device is** dialog box appears. Select the device according to the type of device you connect. Then click **OK**.

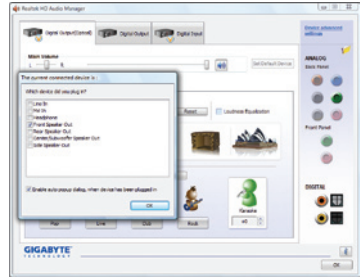

Step 3:

On the **Speakers** screen, click the **Speaker Configuration** tab. In the **Speaker Configuration** list, select **Stereo**, **Quadraphonic**, **5.1 Speaker**, or **7.1 Speaker** according to the type of speaker configuration you wish to set up. Then the speaker setup is completed.

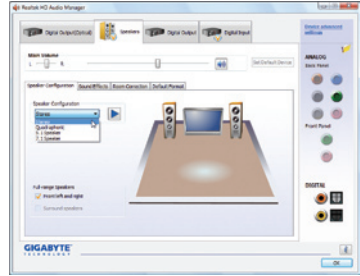

B. Configuring Sound Effect

You may configure an audio environment on the **Sound Effects** tab.

C. Activating an AC'97 Front Panel Audio Module

If your chassis provides an AC'97 front panel audio module, to activate the AC'97 functionality, click the tool icon on the **Speaker Configuration** tab. On the **Connector Settings** dialog box, select the **Disable front panel jack detection** check box. Click **OK** to complete.

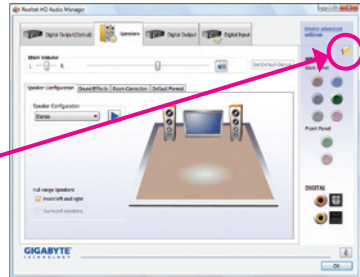
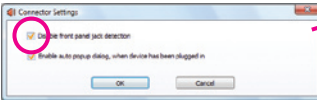

D. Muting the Back Panel Audio (For HD Audio Only)

Click **Device advanced settings** on the top right corner on the **Speaker Configuration** tab to open the **Device advanced settings** dialog box. Select the **Mute the rear output device, when a front headphone plugged in** check box. Click **OK** to complete.

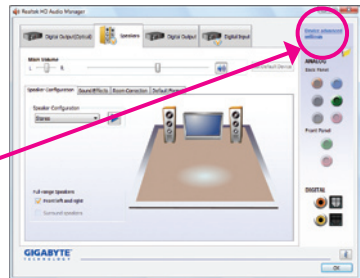
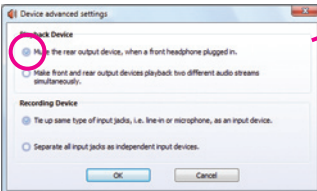

5-2-2 Configuring S/PDIF In/Out

A. S/PDIF In

The S/PDIF In cable (optional) allows you to input digital audio signals to the computer for audio processing.

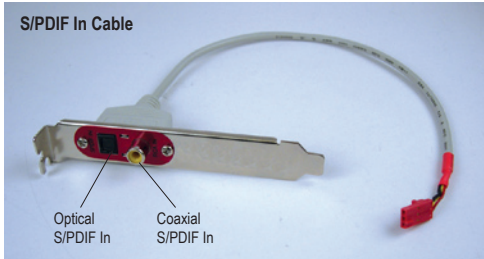

1. Installing the S/PDIF In Cable:

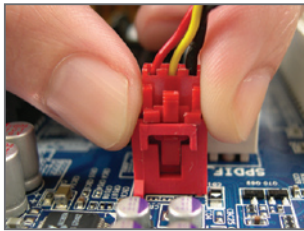

Step 1:
First, attach the connector at the end of the cable to the SPDIF_I header on your motherboard.

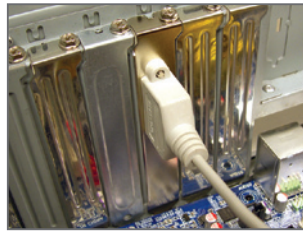

Step 2:
Secure the metal bracket to the chassis back panel with a screw.

2. Configuring S/PDIF In:

On the **Digital Input** screen, click the **Default Format** tab to select the default format. Click **OK** to complete.

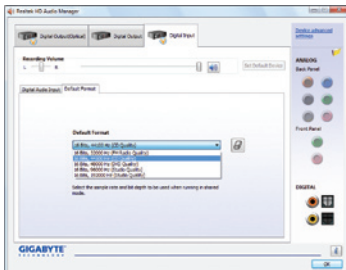

(Note) The actual locations of the S/PDIF In and S/PDIF Out connectors may differ by model.

B. S/PDIF Out

The S/PDIF Out jacks can transmit audio signals to an external decoder for decoding to get the best audio quality.

1. Connecting a S/PDIF Out Cable:



S/PDIF Coaxial Cable

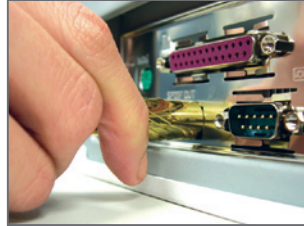

S/PDIF Optical Cable

Connect a S/PDIF coaxial cable or a S/PDIF optical cable (either one) to an external decoder for transmitting the S/PDIF digital audio signals.

2. Configuring S/PDIF Out:

On the **Digital Output** screen, click the **Default Format** tab and then select the sample rate and bit depth. Click **OK** to complete.

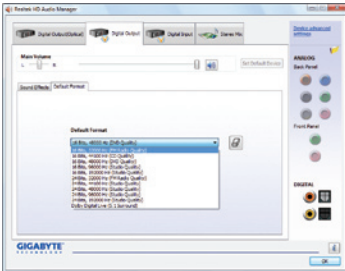

(Note) If you have connected a S/PDIF digital audio cable (provided by expansion cards) to the 2-pin S/PDIF Out header (SPDIF_O) on the motherboard to output digital audio to your expansion card, you can enter the **Digital Output(Optical)** screen to configure further settings, such as the sample rate and bit depth.

5-2-3 Enabling the Dolby Home Theater Function





Before Dolby Home Theater is enabled, you get only 2-channel playback output (from the front speakers) when playing 2-channel stereo sources. You must play 4-, 5.1-, or 7.1- channel content to get 4-, 5.1-, or 7.1- channel audio effects. With Dolby Home Theater enabled, 2-channel stereo content will be transformed into multi-channel audio, creating a virtual surround sound environment ^(Note).

Install the **Dolby GUI Software** driver from the motherboard driver disk. Click the **Start** icon . Point to **All Programs, Dolby Control Center** to access the utility.

(The following illustration demonstrates a 7.1-speaker configuration as an example.)



1. **Dolby Pro Logic IIx**  :
Click Dolby Pro Logic IIx. The system will expand 2-channel audio for a 7.1-channel surround sound playback.
2. **Natural Bass**  :
Click Natural Bass to enable speaker bass effect.

(Note) When Dolby Digital Live is enabled, only digital audio output (S/PDIF) is working, and you will not hear any sound from analog speakers or headphone.

5-2-4 Configuring Microphone Recording

Step 1:

After installing the audio driver, the **HD Audio Manager** icon  will appear in the notification area. Double-click the icon to access the **HD Audio Manager**.



Step 2:

Connect your microphone to the Mic in jack (pink) on the back panel or the Mic in jack (pink) on the front panel. Then configure the jack for microphone functionality.

Note: The microphone functions on the front panel and back panel cannot be used at the same time.

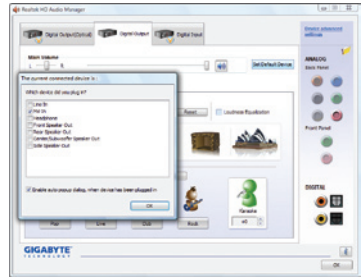

Step 3:

Go to the **Microphone** screen. Do not mute the recording volume, or you'll not be able to record the sound. To hear the sound being recorded during the recording process, do not mute the playback volume. It is recommended that you set the volumes at a middle level.

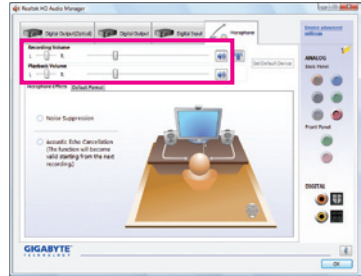

If you want to change the current sound input default device to microphone, right-click on **Microphone** and select **Set Default Device**.

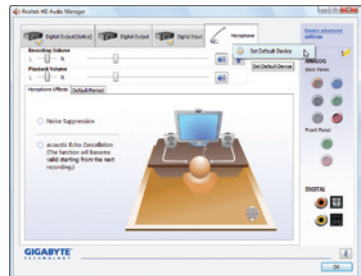

Step 4:

To raise the recording and playback volume for the microphone, click the **Microphone Boost** icon on the right of the **Recording Volume** slider and set the Microphone Boost level.

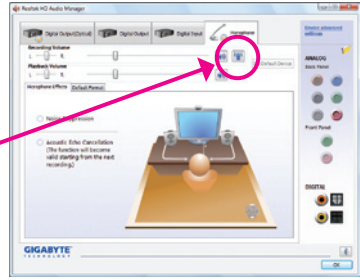

Step 5:

After completing the settings above, click **Start**, point to **All Programs**, point to **Accessories**, and then click **Sound Recorder** to begin the sound recording.

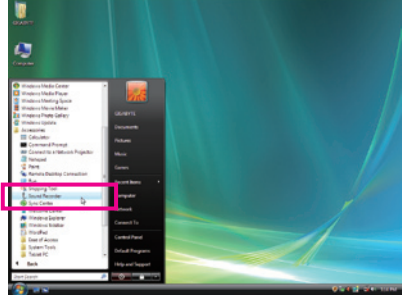

* Enabling Stereo Mix

If the HD Audio Manager does not display the recording device you wish to use, refer to the steps below. The following steps explain how to enable Stereo Mix (which may be needed when you want to record sound from your computer).

Step 1:

Locate the **Volume** icon in the notification area and right-click on this icon. Select **Recording Devices**.



Step 2:

On the **Recording** tab, right-click on an empty space and select **Show Disabled Devices**.

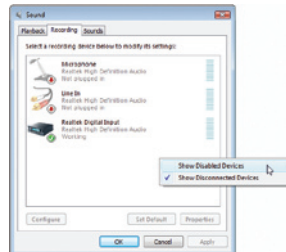

Step 3:

When the **Stereo Mix** item appears, right-click on this item and select **Enable**. Then set it as the default device.

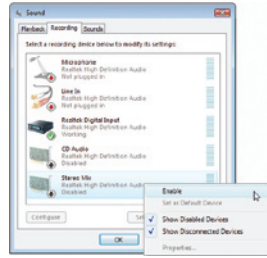

Step 4:

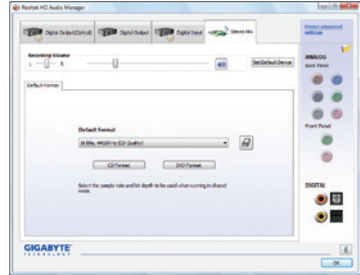

Now you can access the **HD Audio Manager** to configure **Stereo Mix** and use **Sound Recorder** to record the sound.

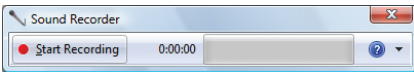

5-2-5 Using the Sound Recorder



A. Recording Sound

1. Make sure you have connected the sound input device (e.g. microphone) to the computer.
2. To record the audio, click the **Start Recording** button .
3. To stop recording audio, click the **Stop Recording** button .

Be sure to save the recorded audio file upon completion.

B. Playing the Recorded Sound

You can play your recording in a digital media player program that supports your audio file format.

5-3 Troubleshooting

5-3-1 Frequently Asked Questions

To read more FAQs for your motherboard, please go to the Support&Downloads\Motherboard\FAQ page on GIGABYTE's website.

Q: In the BIOS Setup program, why are some BIOS options missing?

A: Some advanced options are hidden in the BIOS Setup program. Press <Delete> to enter BIOS Setup during the POST. In the Main Menu, press <Ctrl>+<F1> to show the advanced options.

Q: Why is the light of my keyboard/optical mouse still on after the computer shuts down?

A: Some motherboards provide a small amount of standby power after the computer shuts down and that's why the light is still on.

Q: How do I clear the CMOS values?

A: For motherboards that have a CMOS_SW button, press this button to clear the CMOS values (before doing this, please turn off the computer and unplug the power cord). For motherboards that have a clearing CMOS jumper, refer to the instructions on the CLR_CMOS jumper in Chapter 1 to short the jumper to clear the CMOS values. If your board doesn't have this jumper, refer to the instructions on the motherboard battery in Chapter 1. You can temporarily remove the battery from the battery holder to stop supplying power to the CMOS, which will clear the CMOS values after about one minute.

Q: Why do I still get a weak sound even though I have turned my speaker to the maximum volume?

A: Make sure your speaker is equipped with an internal amplifier. If not, try a speaker with power/amplifier.

Q: Why cannot I install the onboard HD audio driver successfully? (For Windows XP only)

A: Step 1: First, make sure Service Pack 1 or Service Pack 2 has been installed (check in My Computer > Properties > General > System). If not, please update it from Microsoft's website. Then make sure the Microsoft UAA Bus Driver for High Definition Audio has been installed successfully (check in My Computer > Properties > Hardware > Device Manager > System Devices).

Step 2: Check if **Audio Device on High Definition Audio Bus** or **Unknown device** is present in **Device Manager** or **Sound, video, and game controllers**. If yes, please disable this device. (If not, skip this step.)

Step 3: Then go back to My Computer > Properties > Hardware > Device Manager > System devices and right-click on **Microsoft UAA Bus Driver for High Definition Audio** and select **Disable** and **Uninstall**.

Step 4: In **Device Manager**, right-click on the computer name and select **Scan for hardware changes**. When the **Add New Hardware Wizard** appears, click **Cancel**. Then install the onboard HD audio driver from the motherboard driver disk or download the audio driver from GIGABYTE's website to install.

For more details, go to the Support&Downloads\Motherboards\FAQ page on our website and search for "onboard HD audio driver."

Q: What do the beeps emitted during the POST mean?

A: The following Award BIOS beep code descriptions may help you identify possible computer problems.

(For reference only.)

1 short: System boots successfully

1 long, 3 short: Keyboard error

2 short: CMOS setting error

1 long, 9 short: BIOS ROM error

1 long, 1 short: Memory or motherboard error

Continuous long beeps: Graphics card not inserted properly

1 long, 2 short: Monitor or graphics card error

Continuous short beeps: Power error

5-3-2 Troubleshooting Procedure

If you encounter any troubles during system startup, follow the troubleshooting procedure below to solve the problem.

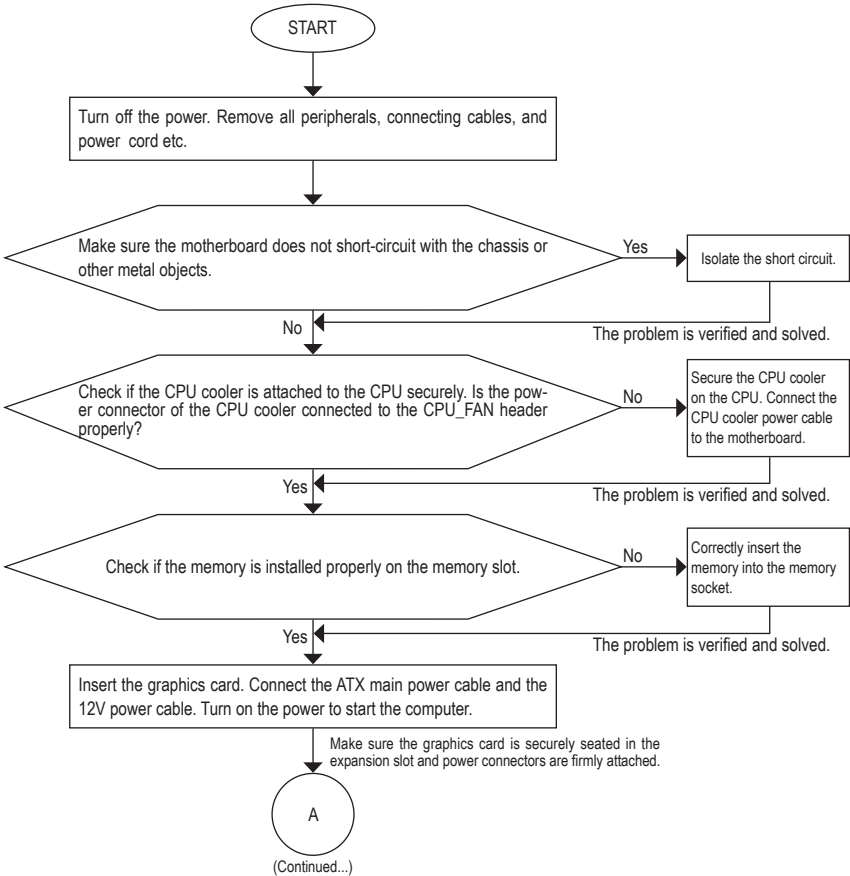

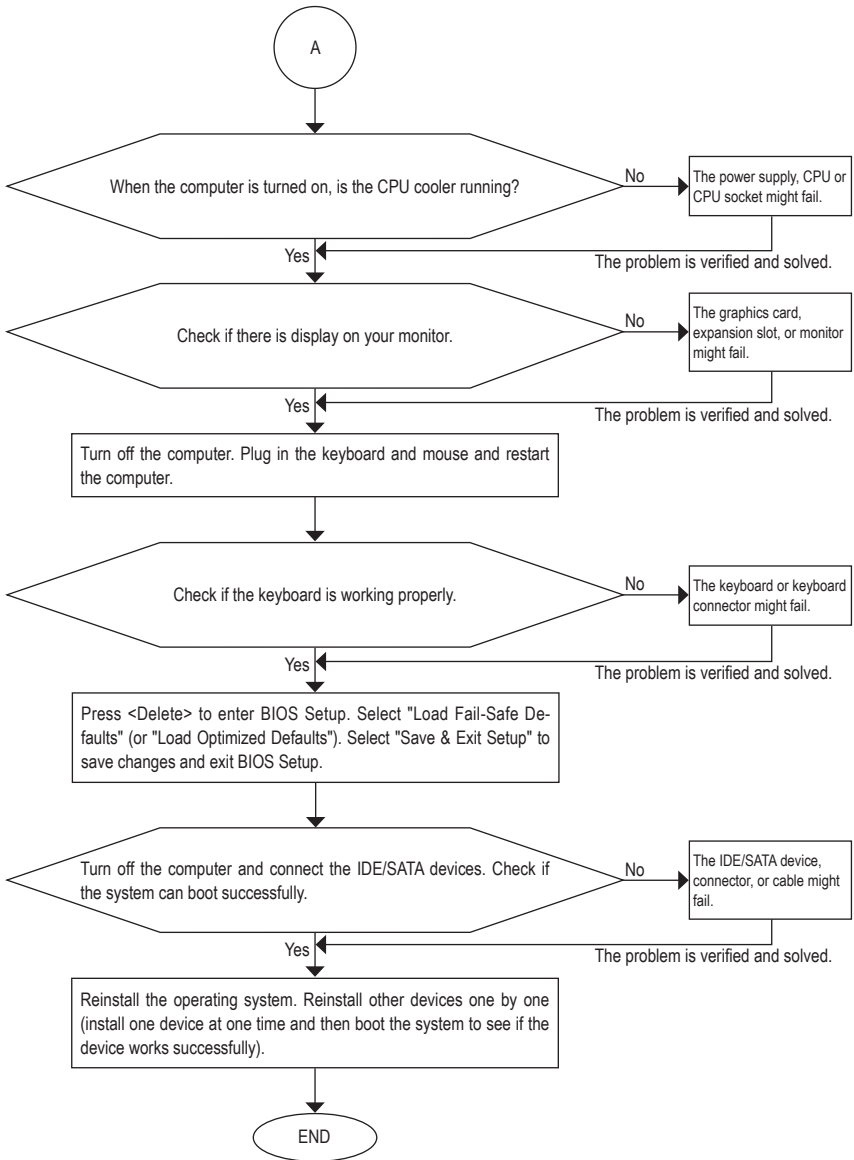

If the procedure above is unable to solve your problem, contact the place of purchase or local dealer for help. Or go to the **Support&Downloads\Technical Service Zone** page to submit your question. Our customer service staff will reply you as soon as possible.

5-4 POST Error Code

POST (hex)	Description
CFh	Test CMOS R/W functionality
C0h	Early chipset initialization: -Disable shadow RAM - Program basic chipset registers
C1h	Detect memory - Auto-detection of DRAM size, type and ECC
C3h	Expand compressed BIOS code to DRAM
C5h	Call chipset hook to copy BIOS back to E000 & F000 shadow RAM
01h	Expand the Xgroup codes locating in physical address 1000:0
02h	DualBIOS init (optional)
03h	Initial Superio_Early_Init switch
05h	1. Blank out screen 2. Clear CMOS error flag
07h	1. Clear 8042 interface 2. Initialize 8042 self-test
08h	1. Test special keyboard controller for Winbond 977 series Super I/O chips 2. Enable keyboard interface
0Ah	1. Disable PS/2 mouse interface (optional) 2. Auto detect ports for keyboard & mouse followed by a port & interface swap (optional) 3. Reset keyboard Super I/O chips
0Eh	Test F000h segment shadow to see whether it is R/W-able or not. If test fails, keep beeping the speaker
10h	Auto detect flash type to load appropriate flash R/W codes into the run time area in F000 for ESCD & DMI support
12h	Use walking 1's algorithm to check out interface in CMOS circuitry. Also set real-time clock power status, and then check for override
14h	Program chipset default values into chipset. Chipset default values are MODBINable by OEM customers
16h	Initial onboard clock generator if Early_Init_Onboard_Generator is defined. See also POST 26h
18h	Detect CPU information including brand, SMI type and CPU level
1Bh	Initial interrupts vector table. If no special specified, all H/W interrupts are directed to SPURIOUS_INT_HDLR & S/W interrupts to SPURIOUS_soft_HDLR
1Dh	Initial EARLY_PM_INIT switch
23h	1. Check validity of RTC value: e.g. a value of 5Ah is an invalid value for RTC minute 2. Load CMOS settings into BIOS stack. If CMOS checksum fails, use default value instead

POST (hex)	Description
24h	Prepare BIOS resource map for PCI & PnP use. If ESCD is valid, take into consideration of the ESCD's legacy information
25h	Early PCI initialization: - Enumerate PCI bus number - Assign memory & I/O resource - Search for a valid VGA device & VGA BIOS, and put it into C000:0
26h	1. If Early_Init_Onboard_Generator is not defined Onboard clock generator initialization. Disable respective clock resource to empty PCI & DIMM slots 2. Init onboard PWM 3. Init onboard H/W monitor devices
27h	Initialize INT 09 buffer
29h	1. Program CPU internal MTRR for 0-640K memory address 2. Initialize the APIC for Pentium class CPU 3. Program early chipset according to CMOS setup Example: onboard IDE controller 4. Measure CPU speed
2Bh	Invoke video BIOS
2Dh	1. Initialize double-byte language font (optional) 2. Put information on screen display, including Award title, CPU type, CPU speed, full screen logo
33h	Reset keyboard if Early_Reset_KB is defined e.g. Winbond 977 series Super I/O chips. See also POST 63h
35h	Test DMA Channel 0
37h	Test DMA Channel 1
39h	Test DMA page registers
3Ch	Test 8254
3Eh	Test 8259 interrupt mask bits for channel 1
40h	Test 8259 interrupt mask bits for channel 2
43h	Test 8259 functionality
47h	Initialize EISA slot
49h	1. Calculate total memory by testing the last double word of each 64K page 2. Program write allocation
4Eh	1. Program MTRR of M1 CPU 2. Initialize L2 cache for P6 class CPU & program CPU with proper cacheable range 3. Initialize the APIC for P6 class CPU 4. On MP platform, adjust the cacheable range to smaller one in case the cacheable ranges between each CPU are not identical
50h	Initialize USB Keyboard & Mouse
52h	Test all memory (clear all extended memory to 0)
53h	Clear password according to H/W jumper (optional)
55h	Display number of processors (multi-processor platform)
57h	1. Display PnP logo 2. Early ISA PnP initialization - Assign CSN to every ISA PnP device

POST (hex)	Description
59h	Initialize the combined Trend Anti-Virus code
5Dh	1. Initialize Init_Onboard_Super_IO 2. Initialize Init_Onboard_AUDIO
60h	Okay to enter Setup utility; i.e. not until this POST stage can users enter the CMOS setup utility
63h	Reset keyboard is Early_Reset_KB is not defined
65h	Initialize PS/2 Mouse
67h	Prepare memory size information for function call: INT 15h ax=E820h
69h	Turn on L2 cache
6Bh	Program chipset registers according to items described in Setup & Auto-configuration table
6Dh	1. Assign resources to all ISA PnP devices 2. Auto assign ports to onboard COM ports if the corresponding item in Setup is set to "AUTO"
6Fh	1. Initialize floppy controller 2. Set up floppy related fields in 40:hardware
75h	Detect & install all IDE devices: HDD, LS120, ZIP, CDROM...
77h	Detect serial ports & parallel ports
7Ah	Detect & install co-processor
7Ch	Init HDD write protect
7Fh	1. Switch back to text mode if full screen logo is supported - If errors occur, report errors & wait for keys - If no errors occur or F1 key is pressed to continue: 2. Clear EPA or customization logo
82h	1. Call chipset power management hook 2. Recover the text font used by EPA logo (not for full screen logo) 3. If password is set, ask for password
83h	Save all data in stack back to CMOS
84h	Initialize ISA PnP boot devices
85h	1. USB final Initialization 2. Switch screen back to text mode
87h	NET PC: Build SYSID structure
89h	1. Assign IRQs to PCI devices 2. Set up ACPI table at top of the memory
8Bh	1. Invoke all ISA adapter ROMs 2. Invoke all PCI ROMs (except VGA)
8Dh	1. Enable/Disable Parity Check according to CMOS setup 2. APM initialization
8Fh	Clear noise of IRQs
93h	Read HDD boot sector information for Trend Anti-Virus code

POST (hex)	Description
94h	<ol style="list-style-type: none"> 1. Enable L2 cache 2. Program daylight saving 3. Program boot up speed 4. Chipset final initialization 5. Power management final initialization 6. Clear screen & display summary table 7. Boot BIOS support (popup menu)
95h	Update keyboard LED & typematic rate
96h	<ol style="list-style-type: none"> 1. Build MP table 2. Initialize power-saving (optional) 3. Set CMOS century to 20h or 19h 4. Load CMOS time into DOS timer tick 5. Build MSIRQ routing table
FFh	Boot attempt (INT 19h)

5-5 Regulatory Statements

Regulatory Notices

This document must not be copied without our written permission, and the contents there of must not be imparted to a third party nor be used for any unauthorized purpose. Contravention will be prosecuted. We believe that the information contained herein was accurate in all respects at the time of printing. GIGABYTE cannot, however, assume any responsibility for errors or omissions in this text. Also note that the information in this document is subject to change without notice and should not be construed as a commitment by GIGABYTE.

Our Commitment to Preserving the Environment

In addition to high-efficiency performance, all GIGABYTE motherboards fulfill European Union regulations for RoHS (Restriction of Certain Hazardous Substances in Electrical and Electronic Equipment) and WEEE (Waste Electrical and Electronic Equipment) environmental directives, as well as most major worldwide safety requirements. To prevent releases of harmful substances into the environment and to maximize the use of our natural resources, GIGABYTE provides the following information on how you can responsibly recycle or reuse most of the materials in your "end of life" product.

Restriction of Hazardous Substances (RoHS) Directive Statement

GIGABYTE products have not intended to add and safe from hazardous substances (Cd, Pb, Hg, Cr+6, PBDE and PBB). The parts and components have been carefully selected to meet RoHS requirement. Moreover, we at GIGABYTE are continuing our efforts to develop products that do not use internationally banned toxic chemicals.

Waste Electrical & Electronic Equipment (WEEE) Directive Statement

GIGABYTE will fulfill the national laws as interpreted from the 2002/96/EC WEEE (Waste Electrical and Electronic Equipment) directive. The WEEE Directive specifies the treatment, collection, recycling and disposal of electric and electronic devices and their components. Under the Directive, used equipment must be marked, collected separately, and disposed of properly.

WEEE Symbol Statement



The symbol shown below is on the product or on its packaging, which indicates that this product must not be disposed of with other waste. Instead, the device should be taken to the waste collection centers for activation of the treatment, collection, recycling and disposal procedure.

The separate collection and recycling of your waste equipment at the time of disposal will help to conserve natural resources and ensure that it is recycled in a manner that protects human health and the environment. For more information about where you can drop off your waste equipment for recycling, please contact your local government office, your household waste disposal service or where you purchased the product for details of environmentally safe recycling.

- ◆ When your electrical or electronic equipment is no longer useful to you, "take it back" to your local or regional waste collection administration for recycling.
- ◆ If you need further assistance in recycling, reusing in your "end of life" product, you may contact us at the Customer Care number listed in your product's user's manual and we will be glad to help you with your effort.

Finally, we suggest that you practice other environmentally friendly actions by understanding and using the energy-saving features of this product (where applicable), recycling the inner and outer packaging (including shipping containers) this product was delivered in, and by disposing of or recycling used batteries properly. With your help, we can reduce the amount of natural resources needed to produce electrical and electronic equipment, minimize the use of landfills for the disposal of "end of life" products, and generally improve our quality of life by ensuring that potentially hazardous substances are not released into the environment and are disposed of properly.

China Restriction of Hazardous Substances Table

The following table is supplied in compliance with China's Restriction of Hazardous Substances (China RoHS) requirements:



关于符合中国《电子信息产品污染控制管理办法》的声明
Management Methods on Control of Pollution from Electronic Information Products
(China RoHS Declaration)

产品中有毒有害物质或元素的名称及含量

Hazardous Substances Table

部件名称 (Parts)	有毒有害物质或元素 (Hazardous Substances)					
	铅 (Pb)	汞 (Hg)	镉 (Cd)	六价铬 (Cr (VI))	多溴联苯 (PBB)	多溴二苯醚 (PBDE)
PCB板 PCB	○	○	○	○	○	○
结构件及风扇 Mechanical parts and Fan	×	○	○	○	○	○
芯片及其他主动零件 Chip and other Active components	×	○	○	○	○	○
连接器 Connectors	×	○	○	○	○	○
被动电子元器件 Passive Components	×	○	○	○	○	○
线材 Cables	○	○	○	○	○	○
焊接金属 Soldering metal	○	○	○	○	○	○
助焊剂, 散热膏, 标签及其他耗材 Flux, Solder Paste, Label and other Consumable Materials	○	○	○	○	○	○
○: 表示该有毒有害物质在该部件所有均质材料中的含量均在SJ/T11363-2006标准规定的限量要求以下。 Indicates that this hazardous substance contained in all homogenous materials of this part is below the limit requirement SJ/T 11363-2006						
×: 表示该有毒有害物质至少在该部件的某一均质材料中的含量超出SJ/T11363-2006标准规定的限量要求。 Indicates that this hazardous substance contained in at least one of the homogenous materials of this part is above the limit requirement in SJ/T 11363-2006						
对销售之日的所发售产品, 本表显示我公司供应链的电子信息产品可能包含这些物质。注意: 在所售产品中可能会也可能不会含有所有列出的部件。 This table shows where these substances may be found in the supply chain of our electronic information products, as of the date of the sale of the enclosed products. Note that some of the component types listed above may or may not be a part of the enclosed product.						



Contact Us

- **GIGA-BYTE TECHNOLOGY CO., LTD.**

Address: No.6, Bau Chiang Road, Hsin-Tien,

Taipei 231, Taiwan

TEL: +886-2-8912-4000

FAX: +886-2-8912-4003

Tech. and Non-Tech. Support (Sales/Marketing) :

<http://ggts.gigabyte.com.tw>

WEB address (English): <http://www.gigabyte.com.tw>

WEB address (Chinese): <http://www.gigabyte.tw>

- **G.B.T. INC. - U.S.A.**

TEL: +1-626-854-9338

FAX: +1-626-854-9339

Tech. Support:

<http://rma.gigabyte.us>

Web address: <http://www.gigabyte.us>

- **G.B.T. INC (USA) - Mexico**

Tel: +1-626-854-9338 x 215 (Soporte de habla hispano)

FAX: +1-626-854-9339

Correo: soporte@gigabyte-usa.com

Tech. Support:

<http://rma.gigabyte.us>

Web address: <http://latam.giga-byte.com>

- **Giga-Byte SINGAPORE PTE. LTD. - Singapore**

WEB address : <http://www.gigabyte.sg>

- **Thailand**

WEB address : <http://th.giga-byte.com>

- **Vietnam**

WEB address : <http://www.gigabyte.vn>

- **NINGBO G.B.T. TECH. TRADING CO., LTD. - China**

WEB address : <http://www.gigabyte.cn>

- Shanghai**

TEL: +86-21-63410999

FAX: +86-21-63410100

- Beijing**

TEL: +86-10-62102838

FAX: +86-10-62102848

- Wuhan**

TEL: +86-27-87851061

FAX: +86-27-87851330

- GuangZhou**

TEL: +86-20-87540700

FAX: +86-20-87544306

- Chengdu**

TEL: +86-28-85236930

FAX: +86-28-85256822

- Xian**

TEL: +86-29-85531943

FAX: +86-29-85510930

- Shenyang**

TEL: +86-24-83992901

FAX: +86-24-83992909

- **GIGABYTE TECHNOLOGY (INDIA) LIMITED - India**

WEB address : <http://www.gigabyte.in>

- **Saudi Arabia**

WEB address : <http://www.gigabyte.com.sa>

- **Gigabyte Technology Pty. Ltd. - Australia**

WEB address : <http://www.gigabyte.com.au>

- **G.B.T. TECHNOLOGY TRADING GMBH - Germany**

WEB address : <http://www.gigabyte.de>

- **G.B.T. TECH. CO., LTD. - U.K.**

WEB address : <http://www.giga-byte.co.uk>

- **Giga-Byte Technology B.V. - The Netherlands**

WEB address : <http://www.giga-byte.nl>

- **GIGABYTE TECHNOLOGY FRANCE - France**

WEB address : <http://www.gigabyte.fr>

- **Sweden**

WEB address : <http://www.gigabyte.se>

- **Italy**

WEB address : <http://www.giga-byte.it>

- **Spain**

WEB address : <http://www.giga-byte.es>

- **Greece**

WEB address : <http://www.gigabyte.com.gr>

- **Czech Republic**

WEB address : <http://www.gigabyte.cz>

- **Hungary**

WEB address : <http://www.giga-byte.hu>

- **Turkey**

WEB address : <http://www.gigabyte.com.tr>

- **Russia**

WEB address : <http://www.gigabyte.ru>

- **Poland**

WEB address : <http://www.gigabyte.pl>

- **Ukraine**

WEB address : <http://www.gigabyte.ua>

- **Romania**

WEB address : <http://www.gigabyte.com.ro>

- **Serbia**

WEB address : <http://www.gigabyte.co.rs>

- **Kazakhstan**

WEB address : <http://www.gigabyte.kz>

You may go to the GIGABYTE website, select your language in the language list on the top right corner of the website.

- **GIGABYTE Global Service System**



To submit a technical or non-technical (Sales/Marketing) question, please link to:

<http://ggts.gigabyte.com.tw>

Then select your language to enter the system.