

# GA-N3150N-D3V

## User's Manual

Rev. 1001



For more product details, please visit GIGABYTE's website.



To reduce the impacts on global warming, the packaging materials of this product are recyclable and reusable. GIGABYTE works with you to protect the environment.

### Declaration of Conformity

We, Manufacturer/Importer,

G.B.T. Technology Trading GmbH

Address: **Bu**enkoppel 16, 22047 Hamburg, Germany

Declare that the product

Product Type: **Motherboard**

Product Name: **GA-N3150N-D3V**

conforms with the essential requirements of the following directives:

**2004/108/EC EMC Directive:**

- |  |                           |
|--|---------------------------|
| <input checked="" type="checkbox"/> Conduction & Radiated Emissions: | EN 55022:2010             |
| <input checked="" type="checkbox"/> Immunity:                        | EN 55024:2010             |
| <input checked="" type="checkbox"/> Power-line harmonics:            | EN 61000-3-2:2006+A2:2009 |
| <input checked="" type="checkbox"/> Power-line flicker:              | EN 61000-3-3:2008         |

**2006/95/EC LVD Directive**

- |   |                         |
|---|-------------------------|
| <input checked="" type="checkbox"/> Safety: | EN60950-1:2006+A12:2011 |
|---|-------------------------|

**2011/65/EU RoHS Directive**

- |   |  |
|---|--|
| <input checked="" type="checkbox"/> Restriction of use of certain substances in electronic equipment: | This product does not contain any of the restricted substances listed in Annex II, in concentrations and applications banned by the directive. |
|---|--|

**CE marking**

CE

Signature: Timmy Huang

(stamp)

Date: Dec. 9, 2015

Name: Timmy Huang

### DECLARATION OF CONFORMITY

Per FCC Part 2 Section 2.1077(a)



Responsible Party Name: **G.B.T. INC. (U.S.A.)**

Address: **17358 Railroad Street**

City of Industry, CA 91748

Phone/Fax No: (626) 854-9338/ (626) 854-9326

hereby declares that the product

**Product Name: Motherboard**

**Model Number: GA-N3150N-D3V**

Conforms to the following specifications:

FCC Part 15, Subpart B, Section 15.107(a) and Section 15.109 (a), Class B Digital Device

**Supplementary Information:**

This device complies with part 15 of the FCC Rules. Operation is subject to the following two conditions: (1) This device may not cause harmful and (2) this device must accept any interference received, including that may cause undesired operation.

Representative Person's Name: ERIC LU

Signature: Eric Lu

Date: Dec. 9, 2015

### Copyright

© 2015 GIGA-BYTE TECHNOLOGY CO., LTD. All rights reserved.

The trademarks mentioned in this manual are legally registered to their respective owners.

### Disclaimer

Information in this manual is protected by copyright laws and is the property of GIGABYTE.

Changes to the specifications and features in this manual may be made by GIGABYTE without prior notice. No part of this manual may be reproduced, copied, translated, transmitted, or published in any form or by any means without GIGABYTE's prior written permission.

- In order to assist in the use of this product, carefully read the User's Manual.
- For product-related information, check on our website at: <http://www.gigabyte.com>

### Identifying Your Motherboard Revision

The revision number on your motherboard looks like this: "REV: X.X." For example, "REV: 1.0" means the revision of the motherboard is 1.0. Check your motherboard revision before updating motherboard BIOS, drivers, or when looking for technical information.

Example:

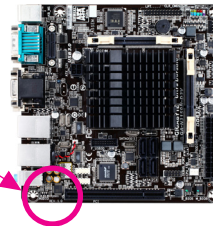
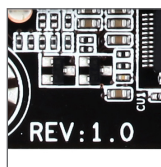

# Table of Contents

GA-N3150N-D3V Motherboard Layout.....	4
Chapter 1 Hardware Installation .....	5
1-1 Installation Precautions.....	5
1-2 Product Specifications.....	6
1-3 Installing the Memory.....	8
1-4 Installing an Expansion Card .....	8
1-5 Back Panel Connectors.....	8
1-6 Internal Connectors.....	10
Chapter 2 BIOS Setup .....	15
2-1 Main .....	16
2-2 Advanced .....	17
2-3 Security .....	21
2-4 Boot.....	22
2-5 Save & Exit.....	24
Chapter 3 Appendix.....	25
Drivers Installation.....	25
Regulatory Statements.....	26
Contact Us .....	28

# GA-N3150N-D3V Motherboard Layout

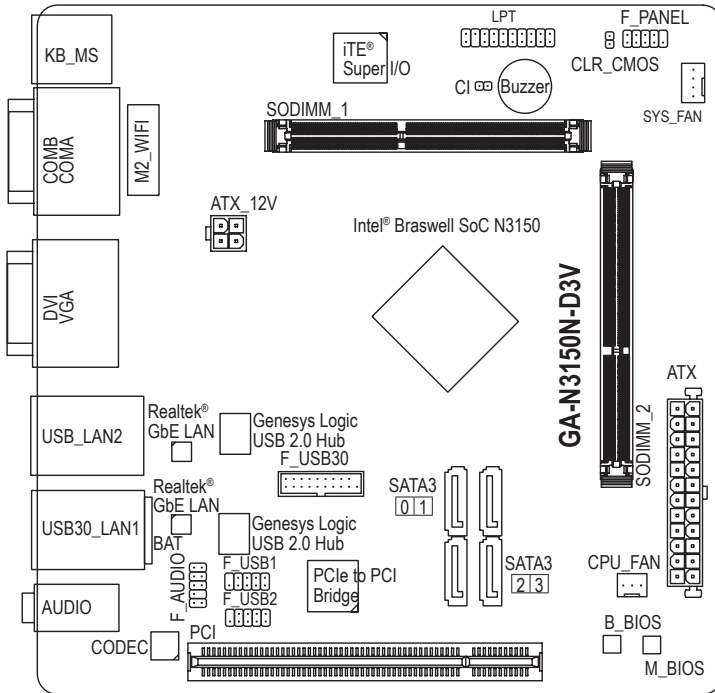

## Box Contents

- GA-N3150N-D3V motherboard
- Motherboard driver disk
- User's Manual
- Two SATA cables
- I/O Shield

\* The box contents above are for reference only and the actual items shall depend on the product package you obtain. The box contents are subject to change without notice.









# Chapter 1 Hardware Installation









## 1-1 Installation Precautions

The motherboard contains numerous delicate electronic circuits and components which can become damaged as a result of electrostatic discharge (ESD). Prior to installation, carefully read the user's manual and follow these procedures:

- Prior to installation, make sure the chassis is suitable for the motherboard.
- Prior to installation, do not remove or break motherboard S/N (Serial Number) sticker or warranty sticker provided by your dealer. These stickers are required for warranty validation.
- Always remove the AC power by unplugging the power cord from the power outlet before installing or removing the motherboard or other hardware components.
- When connecting hardware components to the internal connectors on the motherboard, make sure they are connected tightly and securely.
- When handling the motherboard, avoid touching any metal leads or connectors.
- It is best to wear an electrostatic discharge (ESD) wrist strap when handling electronic components such as a motherboard, CPU or memory. If you do not have an ESD wrist strap, keep your hands dry and first touch a metal object to eliminate static electricity.
- Prior to installing the motherboard, please have it on top of an antistatic pad or within an electrostatic shielding container.
- Before connecting or unplugging the power supply cable from the motherboard, make sure the power supply has been turned off.
- Before turning on the power, make sure the power supply voltage has been set according to the local voltage standard.
- Before using the product, please verify that all cables and power connectors of your hardware components are connected.
- To prevent damage to the motherboard, do not allow screws to come in contact with the motherboard circuit or its components.
- Make sure there are no leftover screws or metal components placed on the motherboard or within the computer casing.
- Do not place the computer system on an uneven surface.
- Do not place the computer system in a high-temperature or wet environment.
- Turning on the computer power during the installation process can lead to damage to system components as well as physical harm to the user.
- If you are uncertain about any installation steps or have a problem related to the use of the product, please consult a certified computer technician.
- If you use an adapter, extension power cable, or power strip, ensure to consult with its installation and/or grounding instructions.

## 1-2 Product Specifications

	CPU	<ul style="list-style-type: none"> <li>◆ Built in with an Intel® Quad-Core Celeron® N3150 SoC (1.6 GHz)               <ul style="list-style-type: none"> <li>* Do not disassemble the onboard SoC and the heatsinks by yourself to avoid damage to these components.</li> </ul> </li> <li>◆ 2 MB Cache</li> </ul>
	Memory	<ul style="list-style-type: none"> <li>◆ 2 x DDR3 SO-DIMM sockets supporting up to 8 GB of system memory               <ul style="list-style-type: none"> <li>* Due to a Windows 32-bit operating system limitation, when more than 4 GB of physical memory is installed, the actual memory size displayed will be less than the size of the physical memory installed.</li> </ul> </li> <li>◆ Dual channel memory architecture</li> <li>◆ Support for DDR3/DDR3L 1600/1333 MHz memory modules               <ul style="list-style-type: none"> <li>* Due to an SoC limitation, if a 1333 MHz memory is installed, it will be downgraded to 1066 MHz.</li> </ul> </li> <li>◆ Support for non-ECC memory modules</li> </ul>
	Onboard Graphics	<ul style="list-style-type: none"> <li>◆ Integrated in the SoC:               <ul style="list-style-type: none"> <li>- 1 x D-Sub port, supporting a maximum resolution of 1920x1200@60 Hz</li> <li>- 1 x DVI-D port, supporting a maximum resolution of 1920x1200@60 Hz                   <ul style="list-style-type: none"> <li>* The DVI-D port does not support D-Sub connection by adapter.</li> </ul> </li> </ul> </li> <li>◆ Maximum shared memory of 512 MB</li> </ul>
	Audio	<ul style="list-style-type: none"> <li>◆ Realtek® ALC887 codec</li> <li>◆ High Definition Audio</li> <li>◆ 2/4/5.1/7.1-channel               <ul style="list-style-type: none"> <li>* To configure 7.1-channel audio, you have to use an HD front panel audio module and enable the multi-channel audio feature through the audio driver.</li> </ul> </li> </ul>
	LAN	<ul style="list-style-type: none"> <li>◆ 2 x Realtek® GbE LAN chips (10/100/1000 Mbit)</li> </ul>
	Expansion Slots	<ul style="list-style-type: none"> <li>◆ 1 x PCI slot</li> <li>◆ 1 x M.2 Socket 1 connector for the wireless communication module (M2_WIFI)</li> </ul>
	Storage Interface	<ul style="list-style-type: none"> <li>◆ SoC:               <ul style="list-style-type: none"> <li>- 2 x SATA 6Gb/s connectors (SATA 3 0/1)</li> </ul> </li> <li>◆ ASMedia® ASM1061 chip:               <ul style="list-style-type: none"> <li>- 2 x SATA 6Gb/s connectors (SATA 3 2/3)</li> </ul> </li> </ul>
	USB	<ul style="list-style-type: none"> <li>◆ SoC:               <ul style="list-style-type: none"> <li>- 4 x USB 3.0/2.0 port (2 ports on the back panel, 2 ports available through the internal USB header)</li> </ul> </li> <li>◆ SoC+2 x GENESYS LOGIC USB 2.0 Hubs:               <ul style="list-style-type: none"> <li>- 6 x USB 2.0/1.1 ports (2 ports on the back panel, 4 ports available through the internal USB headers)</li> </ul> </li> </ul>
	Internal Connectors	<ul style="list-style-type: none"> <li>◆ 1 x 24-pin ATX main power connector</li> <li>◆ 1 x 4-pin ATX 12V power connector</li> <li>◆ 4 x SATA 6Gb/s connectors</li> <li>◆ 1 x CPU fan header</li> <li>◆ 1 x system fan header</li> <li>◆ 1 x front panel header</li> <li>◆ 1 x front panel audio header</li> <li>◆ 1 x USB 3.0/2.0 header</li> <li>◆ 2 x USB 2.0/1.1 headers</li> <li>◆ 1 x parallel port header</li> <li>◆ 1 x Clear CMOS jumper</li> <li>◆ 1 x chassis intrusion header</li> </ul>

 Back Panel Connectors	<ul style="list-style-type: none"> <li>◆ 1 x PS/2 mouse port</li> <li>◆ 1 x PS/2 Keyboard port</li> <li>◆ 2 x serial ports</li> <li>◆ 1 x D-Sub port</li> <li>◆ 1 x DVI-D port</li> <li>◆ 2 x USB 3.0/2.0 ports</li> <li>◆ 2 x USB 2.0/1.1 ports</li> <li>◆ 2 x RJ-45 ports</li> <li>◆ 3 x audio jacks (Line In, Line Out, Mic In)</li> </ul>
 I/O Controller	<ul style="list-style-type: none"> <li>◆ iTE® I/O Controller Chip</li> </ul>
 Hardware Monitor	<ul style="list-style-type: none"> <li>◆ System voltage detection</li> <li>◆ CPU/System temperature detection</li> <li>◆ CPU/System fan speed detection</li> <li>◆ CPU/System fan speed control</li> </ul> <p>* Whether the fan speed control function is supported will depend on the cooler you install.</p>
 BIOS	<ul style="list-style-type: none"> <li>◆ 2 x 64 Mbit flash</li> <li>◆ Use of licensed AMI UEFI BIOS</li> <li>◆ Support for DualBIOS™</li> <li>◆ PnP 1.0a, DMI 2.7, WfM 2.0, SM BIOS 2.7, ACPI 5.0</li> </ul>
 Unique Features	<ul style="list-style-type: none"> <li>◆ Support for Xpress Install</li> <li>◆ Support for @BIOS</li> <li>◆ Support for APP Center</li> </ul> <p>* Available applications in APP Center may vary by motherboard model. Supported functions of each application may also vary depending on motherboard specifications.</p>
 Bundled Software	<ul style="list-style-type: none"> <li>◆ Norton® Internet Security (OEM version)</li> </ul>
 Operating System	<ul style="list-style-type: none"> <li>◆ Support for Windows 10 32-bit/64-bit</li> <li>◆ Support for Windows 8.1/7 64-bit</li> </ul> <p>* Please download the "Windows USB Installation Tool" from GIGABYTE's website and install it before installing Windows 7.</p>
 Form Factor	<ul style="list-style-type: none"> <li>◆ Mini-ITX Form Factor; 17.0cm x 17.0cm</li> </ul>

\* GIGABYTE reserves the right to make any changes to the product specifications and product-related information without prior notice.



Please visit GIGABYTE's website for support lists of memory modules.



Please visit the **Support Utility List** page on GIGABYTE's website to download the latest version of apps.



Please visit GIGABYTE's website for details on hardware installation.

## 1-3 Installing the Memory



Read the following guidelines before you begin to install the memory:

- Make sure that the motherboard supports the memory. It is recommended that memory of the same capacity, brand, speed, and chips be used. (Go to GIGABYTE's website for the latest supported memory speeds and memory modules.)
- Always turn off the computer and unplug the power cord from the power outlet before installing the memory to prevent hardware damage.
- Memory modules have a foolproof design. A memory module can be installed in only one direction. If you are unable to insert the memory, switch the direction.

### Dual Channel Memory Configuration

This motherboard provides two memory sockets and supports Dual Channel Technology. After the memory is installed, the BIOS will automatically detect the specifications and capacity of the memory. Enabling Dual Channel memory mode will double the original memory bandwidth.

The two memory sockets are divided into two channels and each channel has one memory socket as following:

▶▶ Channel A: SODIMM\_1

▶▶ Channel B: SODIMM\_2

Due to SoC limitations, read the following guidelines before installing the memory in Dual Channel mode.

1. If only one memory module is to be installed, be sure to install it in the SODIMM\_1 socket, and Dual Channel mode cannot be enabled if only one memory module is installed.
2. When enabling Dual Channel mode with two memory modules, it is recommended that memory of the same capacity, brand, speed, and chips be used for optimum performance.

## 1-4 Installing an Expansion Card



Read the following guidelines before you begin to install an expansion card:

- Make sure the motherboard supports the expansion card. Carefully read the manual that came with your expansion card.
- Always turn off the computer and unplug the power cord from the power outlet before installing an expansion card to prevent hardware damage.

## 1-5 Back Panel Connectors

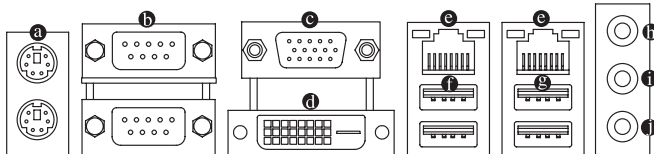

### **a** PS/2 Keyboard and PS/2 Mouse Port

Use the upper port (green) to connect a PS/2 mouse and the lower port (purple) to connect a PS/2 keyboard.

### **b** Serial Port

Use the serial port to connect devices such as a mouse, modem or other peripherals.

### **c** D-Sub Port

The D-Sub port supports a 15-pin D-Sub connector and supports a maximum resolution of 1920x1200@60 Hz (the actual resolutions supported depend on the monitor being used). Connect a monitor that supports D-Sub connection to this port.



Dual-display configurations are supported after you install motherboard drivers in OS.



❶ **DVI-D Port** (Note)

The DVI-D port conforms to the DVI-D specification and supports a maximum resolution of 1920x1200@60 Hz (the actual resolutions supported depend on the monitor being used). Connect a monitor that supports DVI-D connection to this port.

❷ **RJ-45 LAN Port**

The Gigabit Ethernet LAN port provides Internet connection at up to 1 Gbps data rate. The following describes the states of the LAN port LEDs.

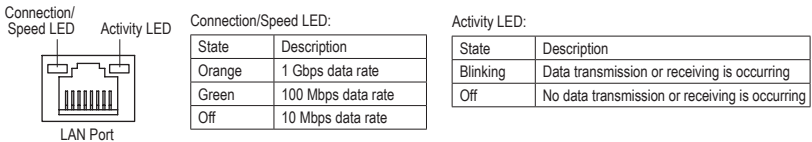

❸ **USB 2.0/1.1 Port**

The USB port supports the USB 2.0/1.1 specification. Use this port for USB devices such as a USB keyboard/mouse, USB printer, USB flash drive and etc.

❹ **USB 3.0/2.0 Port**

The USB 3.0 port supports the USB 3.0 specification and is compatible to the USB 2.0/1.1 specification. Use this port for USB devices.

❺ **Line In (Blue)**

The line in jack. Use this audio jack for line in devices such as an optical drive, walkman, etc.

❻ **Line Out (Green)**

The line out jack. Use this audio jack for a headphone or 2-channel speaker. This jack can be used to connect front speakers in a 4/5.1/7.1-channel audio configuration.

❼ **Mic In (Pink)**

The Mic in jack.



To configure 7.1-channel audio, you have to use an HD front panel audio module and enable the multi-channel audio feature through the audio driver.



- When removing the cable connected to a back panel connector, first remove the cable from your device and then remove it from the motherboard.
- When removing the cable, pull it straight out from the connector. Do not rock it side to side to prevent an electrical short inside the cable connector.

(Note) The DVI-D port does not support D-Sub connection by adapter.

## 1-6 Internal Connectors

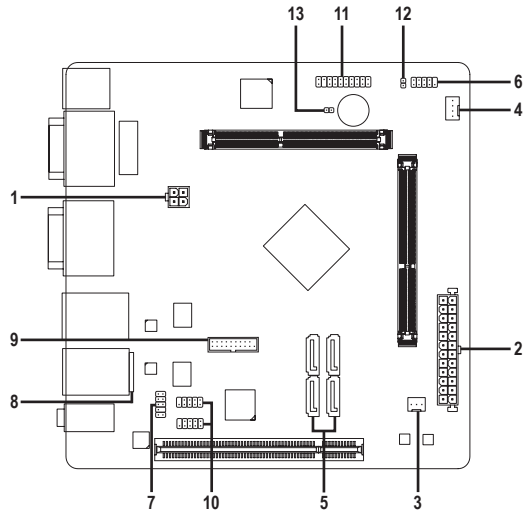

1) ATX_12V	8) BAT
2) ATX	9) F_USB30
3) CPU_FAN	10) F_USB1/F_USB2
4) SYS_FAN	11) LPT
5) SATA3 0/1/2/3	12) CLR_CMOS
6) F_PANEL	13) CI
7) F_AUDIO	



Read the following guidelines before connecting external devices:

- First make sure your devices are compliant with the connectors you wish to connect.
- Before installing the devices, be sure to turn off the devices and your computer. Unplug the power cord from the power outlet to prevent damage to the devices.
- After installing the device and before turning on the computer, make sure the device cable has been securely attached to the connector on the motherboard.

### 1/2) ATX\_12V/ATX (2x2 12V Power Connector and 2x12 Main Power Connector)

With the use of the power connector, the power supply can supply enough stable power to all the components on the motherboard. Before connecting the power connector, first make sure the power supply is turned off and all devices are properly installed. The power connector possesses a foolproof design. Connect the power supply cable to the power connector in the correct orientation.

The 12V power connector mainly supplies power to the CPU. If the 12V power connector is not connected, the computer will not start.

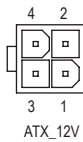

ATX\_12V:

Pin No.	Definition
1	GND
2	GND
3	+12V
4	+12V

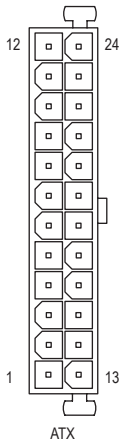

ATX:

Pin No.	Definition	Pin No.	Definition
1	3.3V	13	3.3V
2	3.3V	14	-12V
3	GND	15	GND
4	+5V	16	PS_ON (soft On/Off)
5	GND	17	GND
6	+5V	18	GND
7	GND	19	GND
8	Power Good	20	NC
9	5VSB (stand by +5V)	21	+5V
10	+12V	22	+5V
11	+12V (Only for 2x12-pin ATX)	23	+5V (Only for 2x12-pin ATX)
12	3.3V (Only for 2x12-pin ATX)	24	GND (Only for 2x12-pin ATX)

### 3/4) CPU\_FAN/SYS\_FAN (Fan Headers)

The motherboard has a 3-pin CPU fan header (CPU\_FAN) and a 4-pin system fan header (SYS\_FAN). Most fan headers possess a foolproof insertion design. When connecting a fan cable, be sure to connect it in the correct orientation (the black connector wire is the ground wire). The speed control function requires the use of a fan with fan speed control design. For optimum heat dissipation, it is recommended that a system fan be installed inside the chassis.



CPU\_FAN:

Pin No.	Definition
1	GND
2	Speed Control
3	Sense

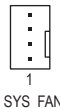

SYS\_FAN:

Pin No.	Definition
1	GND
2	Speed Control
3	Sense
4	VCC



These fan headers are not configuration jumper blocks. Do not place a jumper cap on the headers.

## 5) SATA3 0/1/2/3 (SATA 6Gb/s Connectors)

The SATA connectors conform to SATA 6Gb/s standard and are compatible with SATA 3Gb/s and SATA 1.5Gb/s standard. Each SATA connector supports a single SATA device.

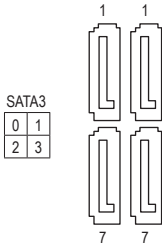

Pin No.	Definition
1	GND
2	TXP
3	TXN
4	GND
5	RXN
6	RXP
7	GND

## 6) F\_PANEL (Front Panel Header)

Connect the power switch, reset switch, and system status indicator on the chassis to this header according to the pin assignments below. Note the positive and negative pins before connecting the cables.

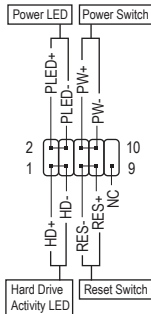

- **PLED (Power LED, Yellow):**

System Status	LED
S0	On
S3/S4/S5	Off

Connects to the power status indicator on the chassis front panel. The LED is on when the system is operating. The LED is off when the system is in S3/S4 sleep state or powered off (S5).

- **PW (Power Switch, Red):**

Connects to the power switch on the chassis front panel. You may configure the way to turn off your system using the power switch (refer to Chapter 2, "BIOS Setup," "Chipset," for more information).

- **HD (Hard Drive Activity LED, Blue):**

Connects to the hard drive activity LED on the chassis front panel. The LED is on when the hard drive is reading or writing data.

- **RES (Reset Switch, Green):**

Connects to the reset switch on the chassis front panel. Press the reset switch to restart the computer if the computer freezes and fails to perform a normal restart.

- **NC (Purple):** No connection.



The front panel design may differ by chassis. A front panel module mainly consists of power switch, reset switch, power LED, hard drive activity LED and etc. When connecting your chassis front panel module to this header, make sure the wire assignments and the pin assignments are matched correctly.

## 7) F\_AUDIO (Front Panel Audio Header)

The front panel audio header supports Intel High Definition audio (HD) and AC'97 audio. You may connect your chassis front panel audio module to this header. Make sure the wire assignments of the module connector match the pin assignments of the motherboard header. Incorrect connection between the module connector and the motherboard header will make the device unable to work or even damage it.



For HD Front Panel Audio:

Pin No.	Definition
1	MIC2_L
2	GND
3	MIC2_R
4	-ACZ_DET
5	LINE2_R
6	Sense
7	FAUDIO_JD
8	No Pin
9	LINE2_L
10	Sense

For AC'97 Front Panel Audio:

Pin No.	Definition
1	MIC
2	GND
3	MIC Power
4	NC
5	Line Out (R)
6	NC
7	NC
8	No Pin
9	Line Out (L)
10	NC



- The front panel audio header supports HD audio by default.
- Audio signals will be present on both of the front and back panel audio connections simultaneously.
- Some chassis provide a front panel audio module that has separated connectors on each wire instead of a single plug. For information about connecting the front panel audio module that has different wire assignments, please contact the chassis manufacturer.

## 8) BAT (Battery)

The battery provides power to keep the values (such as BIOS configurations, date, and time information) in the CMOS when the computer is turned off. Replace the battery when the battery voltage drops to a low level, or the CMOS values may not be accurate or may be lost.

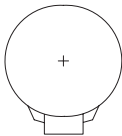

You may clear the CMOS values by removing the battery cable:

1. Turn off your computer and unplug the power cord.
2. Unplug the the battery cable from the battery cable header and wait for one minute.
3. Plug in the battery cable.
4. Plug in the power cord and restart your computer.



- Always turn off your computer and unplug the power cord before replacing the battery.
- Replace the battery with an equivalent one. Danger of explosion if the battery is replaced with an incorrect model.
- Contact the place of purchase or local dealer if you are not able to replace the battery by yourself or uncertain about the battery model.
- When installing the battery, note the orientation of the positive side (+) and the negative side (-) of the battery (the positive side should face up).
- Used batteries must be handled in accordance with local environmental regulations.

### 9) F\_USB30 (USB 3.0/2.0 Header)

The header conforms to USB 3.0/2.0 specification and each header can provide two USB ports. For purchasing the optional 3.5" front panel that provides two USB 3.0/2.0 ports, please contact the local dealer.

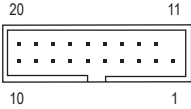

Pin No.	Definition	Pin No.	Definition
1	VBUS	11	D2+
2	SSRX1-	12	D2-
3	SSRX1+	13	GND
4	GND	14	SSTX2+
5	SSTX1-	15	SSTX2-
6	SSTX1+	16	GND
7	GND	17	SSRX2+
8	D1-	18	SSRX2-
9	D1+	19	VBUS
10	NC	20	No Pin

### 10) F\_USB1/F\_USB2 (USB 2.0/1.1 Headers)

The headers conform to USB 2.0/1.1 specification. Each USB header can provide two USB ports via an optional USB bracket. For purchasing the optional USB bracket, please contact the local dealer.



Pin No.	Definition	Pin No.	Definition
1	Power (5V)	6	USB DY+
2	Power (5V)	7	GND
3	USB DX-	8	GND
4	USB DY-	9	No Pin
5	USB DX+	10	NC



- Do not plug the IEEE 1394 bracket (2x5-pin) cable into the USB header.
- Prior to installing the USB bracket, be sure to turn off your computer and unplug the power cord from the power outlet to prevent damage to the USB bracket.

### 11) LPT (Parallel Port Header)

The LPT header can provide one parallel port via an optional LPT port cable. For purchasing the optional LPT port cable, please contact the local dealer.



Pin No.	Definition	Pin No.	Definition	Pin No.	Definition
1	STB-	10	GND	19	ACK-
2	AFD-	11	PD4	20	GND
3	PD0	12	GND	21	BUSY
4	ERR-	13	PD5	22	GND
5	PD1	14	GND	23	PE
6	INIT-	15	PD6	24	No Pin
7	PD2	16	GND	25	SLCT
8	SLIN-	17	PD7	26	GND
9	PD3	18	GND		

## 12) CLR\_CMOS (Clear CMOS Jumper)

Use this jumper to clear the BIOS configuration and reset the CMOS values to factory defaults. To clear the CMOS values, use a metal object like a screwdriver to touch the two pins for a few seconds.



Open: Normal



Short: Clear CMOS Values



- Always turn off your computer and unplug the power cord from the power outlet before clearing the CMOS values.
- After system restart, go to BIOS Setup to load factory defaults (select Load Optimized Defaults) or manually configure the BIOS settings (refer to Chapter 2, "BIOS Setup," for BIOS configurations).

## 13) CI (Chassis Intrusion Header)

This motherboard provides a chassis detection feature that detects if the chassis cover has been removed. This function requires a chassis with chassis intrusion detection design.



Pin No.	Definition
1	Signal
2	GND

# Chapter 2 BIOS Setup

BIOS (Basic Input and Output System) records hardware parameters of the system in the CMOS on the motherboard. Its major functions include conducting the Power-On Self-Test (POST) during system startup, saving system parameters and loading operating system, etc. BIOS includes a BIOS Setup program that allows the user to modify basic system configuration settings or to activate certain system features.

When the power is turned off, the battery on the motherboard supplies the necessary power to the CMOS to keep the configuration values in the CMOS.

To access the BIOS Setup program, press the <Delete> key during the POST when the power is turned on.

To upgrade the BIOS, use the GIGABYTE @BIOS utility, which is a Windows-based utility that searches and downloads the latest version of BIOS from the Internet and updates the BIOS.



- Because BIOS flashing is potentially risky, if you do not encounter problems using the current version of BIOS, it is recommended that you not flash the BIOS. To flash the BIOS, do it with caution. Inadequate BIOS flashing may result in system malfunction.
- It is recommended that you not alter the default settings (unless you need to) to prevent system instability or other unexpected results. Inadequately altering the settings may result in system's failure to boot. If this occurs, try to clear the CMOS values and reset the board to default values. (Refer to the "Restore Defaults" section in this chapter or introductions of the battery/clear CMOS jumper in Chapter 1 for how to clear the CMOS values.)

## 2-1 Main

Once you enter the BIOS Setup program, the Main Menu (as shown below) appears on the screen. Use arrow keys to move among the items and press <Enter> to accept or enter a sub-menu.

### Main Menu Help

The on-screen description of a highlighted setup option is displayed on the bottom line of the Main Menu.

### Submenu Help

While in a submenu, press <F1> to display a help screen (General Help) of function keys available for the menu. Press <Esc> to exit the help screen. Help for each item is in the Item Help block on the right side of the submenu.

### (Sample BIOS Version: D3)



- When the system is not stable as usual, select the **Restore Defaults** item to set your system to its defaults.
- The BIOS Setup menus described in this chapter are for reference only and may differ by BIOS version.

Aptio Setup Utility - Copyright (C) 2015 American Megatrends, Inc.				
Main	Advanced	Security	Boot	Save & Exit
BIOS Information				
BIOS ID	8A08AG07			
Project Name	N315ND3V			
BIOS Version	D3			
Build Date and Time	11/02/2015 10:59:39			
Memory Information				
Total Memory	4096 MB (LPDDR3)			
Memory Slot0	4096 MB (LPDDR3)			
Memory Slot1	Not Present			
TXE Information				
TXE FW Version	02.00.00.2073			
System Language	[English]			
System Date	[Fri 11/13/2015]			
System Time	[05:57:28]			
				→←: Select Screen ↑↓: Select Item Enter: Select +/-: Change Opt. F1: General Help F2: Previous Values F3: Optimized Defaults F4: Save & Exit ESC: Exit
Version 2.17.1249. Copyright (C) 2015 American Megatrends, Inc.				

This section provides information on your motherboard model and BIOS version. You can also select the default language used by the BIOS and manually set the system time.

- **System Language**  
Selects the default language used by the BIOS.
- **System Date**  
Sets the system date. The date format is week (read-only), month, date, and year. Use <Tab> to switch between the Month, Date, and Year fields and use the <+> or <-> key to set the desired value.
- **System Time**  
Sets the system time. The time format is hour, minute, and second. For example, 1 p.m. is 13:00:00. Use <Tab> to switch between the Hour, Minute, and Second fields and use the <+> or <-> key to set the desired value.
- **Access Level**  
Displays the current access level depending on the type of password protection used. (If no password is set, the default will display as **Administrator**.) The Administrator level allows you to make changes to all BIOS settings; the User level only allows you to make changes to certain BIOS settings but not all.



## 2-2 Advanced

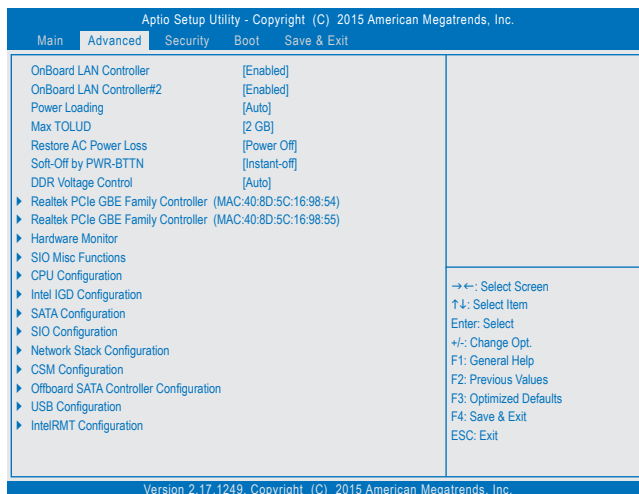

- ☞ **OnBoard LAN Controller (LAN1)**  
 Enables or disables the onboard LAN function. (Default: Enabled)  
 If you wish to install a 3rd party add-in network card instead of using the onboard LAN, set this item to **Disabled**.
- ☞ **OnBoard LAN Controller#2 (LAN2)**  
 Enables or disables the onboard LAN function. (Default: Enabled)  
 If you wish to install a 3rd party add-in network card instead of using the onboard LAN, set this item to **Disabled**.
- ☞ **Power Loading**  
 Enables or disables dummy load. When the power supply is at low load, a self-protection will activate causing it to shutdown or fail. If this occurs, please set to **Enabled**. **Auto** lets the BIOS automatically configure this setting. (Default: Auto)
- ☞ **Max TOLUD**  
 Allows you to configure the maximum TOLUD value. 2 GB is the default.
- ☞ **Restore AC Power Loss**  
 Determines the state of the system after the return of power from an AC power loss.

  - ▶▶ Power Off      The system stays off upon the return of the AC power. (Default)
  - ▶▶ Power On        The system is turned on upon the return of the AC power.
  - ▶▶ Last State      The system returns to its last known awake state upon the return of the AC power.
- ☞ **Soft-Off by PWR-BTTN**  
 Configures the way to turn off the computer in MS-DOS mode using the power button.

  - ▶▶ Instant-Off      Press the power button and then the system will be turned off instantly. (Default)
  - ▶▶ Delay 4 Sec.    Press and hold the power button for 4 seconds to turn off the system. If the power button is pressed for less than 4 seconds, the system will enter suspend mode.
- ☞ **DDR Voltage Control**  
 Allows you to set the memory voltage. Options are: 1.35V, 1.50V, Auto. Auto lets the BIOS automatically configure this setting. (Default: Auto)

▶ **Realtek PCIe GBE Family Controller (LAN1)**

This sub-menu provides information on LAN configuration and related configuration options.

▶ **Realtek PCIe GBE Family Controller (LAN2)**

This sub-menu provides information on LAN configuration and related configuration options.

▶ **Hardware Monitor**

☞ **CPU Temperature/System Temperature**

Displays current CPU/system temperature.

☞ **CPU/System Fan Speed**

Displays current CPU/system fan speeds.

☞ **VCore/VCC3/+12V/VCC/CPU\_VAXG/Vnn/DDR1\_35V**

Displays the current system voltages.

▶ **SIO Misc Functions**

☞ **ErP**

Determines whether to let the system consume least power in S5 (shutdown) state. (Default: Disabled)

Note: When this item is set to Enabled, the following functions will become unavailable: Resume by Alarm, PME event wake up, power on by mouse, power on by keyboard, and wake on LAN.

☞ **Case Open**

Displays the detection status of the chassis intrusion detection device attached to the motherboard CI header. If the system chassis cover is removed, this field will show "Open", otherwise it will show "Close."

To clear the chassis intrusion status record, set **Reset Case Open Status** to **Enabled**, save the settings to the CMOS, and then restart your system.

☞ **Reset Case Open Status**

▶▶ Disabled Keeps or clears the record of previous chassis intrusion status. (Default)

▶▶ Enabled Clears the record of previous chassis intrusion status and the **Case Open** field will show "No" at next boot.

☞ **Case intrusion Prompt**

Allows you to determine whether to display chassis intrusion notification at system startup. (Default: Disabled)

▶ **CPU Configuration**

☞ **Limit CPUID Maximum**

Allows you to determine whether to limit CPUID maximum value. Set this item to **Disabled** for Windows XP operating system; set this item to **Enabled** for legacy operating system such as Windows NT4.0. (Default: Disabled)

☞ **Intel Virtualization Technology**

Enables or disables Intel® Virtualization Technology. Virtualization enhanced by Intel® Virtualization Technology will allow a platform to run multiple operating systems and applications in independent partitions. With virtualization, one computer system can function as multiple virtual systems. (Default: Enabled)

☞ **Power Technology**

Allows you to configure Intel® power management features. (Default: Custom)

☞ **EIST**

Enables or disables Enhanced Intel® Speed Step Technology (EIST). Depending on CPU loading, Intel® EIST technology can dynamically and effectively lower the CPU voltage and core frequency to decrease average power consumption and heat production. **Auto** lets the BIOS automatically configure this setting. (Default: Enabled)

☞ **Turbo Mode**

Allows you to determine whether to enable the Intel® CPU Turbo Boost technology. (Default: Enabled)

▶ **Intel IGD Configuration**

This section provides onboard graphics-related configuration options.

☞ **Integratrd Graphics Device**

Enables or disables the onboard graphics function. (Default: Enabled)

▶ **SATA Configuration**

☞ **SATA Controller**

Enables or disables the integrated SATA controllers. (Default: Enabled)

☞ **SATA Interface Speed**

Allows you to set the operation mode of the SATA ports to Gen 1, Gen 2, or Gen 3. (Default: Gen 3)

▶ **Serial ATA Port 0/1**

☞ **Port 0/1**

Enables or disables each SATA port. (Default: Enabled)

▶ **SIO Configuration**

This section provides information on the super I/O chip and allows you to configure the serial port and parallel port.

▶ **Network Stack Configuration**

☞ **Network stack**

Disables or enables booting from the network to install a GPT format OS, such as installing the OS from the Windows Deployment Services server. (Default: Disabled)

☞ **Ipv4 PXE Support**

Enables or disables IPv4 PXE Support. This item is configurable only when **Network stack** is enabled.

☞ **Ipv6 PXE Support**

Enables or disables IPv6 PXE Support. This item is configurable only when **Network stack** is enabled.

☞ **PXE boot wait time**

Allows you to set the waiting time for cancelling the PXE boot by pressing the <ESC> key. This item is configurable only when **Network stack** is enabled.

☞ **Media detect count**

Allows you to set the number of times to check the presence of media. This item is configurable only when **Network stack** is enabled.

▶ **CSM Configuration**

☞ **CSM Support**

Enables or disables UEFI CSM (Compatibility Support Module) to support a legacy PC boot process.

▶▶ Enabled      Enables UEFI CSM. (Default)

▶▶ Disabled      Disables UEFI CSM and supports UEFI BIOS boot process only.

## ⊟ Network

Allows you to select whether to enable the UEFI or legacy option ROM for the LAN controller.

- ▶▶ Do not launch Disables option ROM.
- ▶▶ UEFI Enables UEFI option ROM only. (Default)
- ▶▶ Legacy Enables legacy option ROM only.

This item is configurable only when **CSM Support** is set to **Enabled**.

## ⊟ Storage

Allows you to select whether to enable the UEFI or legacy option ROM for the storage device controller.

- ▶▶ Do not launch Disables option ROM.
- ▶▶ UEFI Enables UEFI option ROM only. (Default)
- ▶▶ Legacy Enables legacy option ROM only.

This item is configurable only when **CSM Support** is set to **Enabled**.

## ⊟ Video

Allows you to select whether to enable the UEFI or legacy option ROM for the graphics controller.

- ▶▶ Do not launch Disables option ROM.
- ▶▶ UEFI Enables UEFI option ROM only.
- ▶▶ Legacy Enables legacy option ROM only. (Default)

This item is configurable only when **CSM Support** is set to **Enabled**.

## ⊟ Other PCI devices

Allows you to select whether to enable the UEFI or Legacy option ROM for the PCI device controller other than the LAN, storage device, and graphics controllers.

- ▶▶ Do not launch Disables option ROM.
- ▶▶ UEFI Enables UEFI option ROM only. (Default)
- ▶▶ Legacy Enables legacy option ROM only.

This item is configurable only when **CSM Support** is set to **Enabled**.

## ▶ OffBoard SATA Controller Configuration (SATA 3 2/3 Connectors, Controlled by ASMedia® ASM1061 Chip)

Displays information on your SATA if installed.

## ▶ USB Configuration

### ⊟ Legacy USB Support

Allows USB keyboard/mouse to be used in MS-DOS. (Default: Enabled)

### ⊟ xHCI Mode

Allows you to determine the operating mode for the xHCI controller in OS.

- ▶▶ Enabled All shared ports are eventually routed to the xHCI controller during the BIOS boot process. If BIOS does not have pre-boot support for the xHCI controller, it should initially route the sharable ports to the EHCI controller and then prior to OS boot it should route the ports to xHCI controller. Note: OS has to provide support for the xHCI controller in this mode. If the OS does not provide support, all sharable ports won't work. (Default)
- ▶▶ Disabled The USB 3.0 ports are routed to the EHCI controller and the xHCI controller is turned off. All USB 3.0 devices function as High Speed devices regardless of xHCI software support/availability.

### ⊟ USB Mass Storage Driver Support

Enables or disables support for USB storage devices. (Default: Enabled)

### ⊟ Mass Storage Devices

Displays a list of connected USB mass storage devices. This item appears only when a USB storage device is installed.

## ▶ IntelRMT Configuration

### ☞ Intel RMT Support

Enables or disables Intel® Ready Mode Technology. (Default: Disabled)

## 2-3 Security

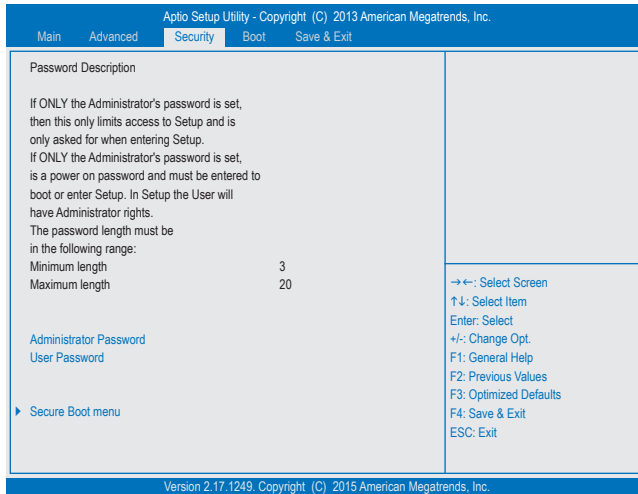

### ☞ Administrator Password

Allows you to configure an administrator password. Press <Enter> on this item, type the password, and then press <Enter>. You will be requested to confirm the password. Type the password again and press <Enter>. You must enter the administrator password (or user password) at system startup and when entering BIOS Setup. Differing from the user password, the administrator password allows you to make changes to all BIOS settings.

### ☞ User Password

Allows you to configure a user password. Press <Enter> on this item, type the password, and then press <Enter>. You will be requested to confirm the password. Type the password again and press <Enter>. You must enter the administrator password (or user password) at system startup and when entering BIOS Setup. However, the user password only allows you to make changes to certain BIOS settings but not all. To cancel the password, press <Enter> on the password item and when requested for the password, enter the correct one first. When prompted for a new password, press <Enter> without entering any password. Press <Enter> again when prompted to confirm.

NOTE: Before setting the User Password, be sure to set the Administrator Password first.

### ☞ HDD Security Configuration

Displays a list of connected hard drives and allows you to set a password for a specific hard drive. This item appears only when a hard drive is installed.

## ▶ Secure Boot menu

### ☞ System Mode

Displays the current system mode.

☞ **Secure Boot**

Displays the current secure boot state.

☞ **Vendor Keys**

Displays the vendor keys.

☞ **Secure Boot**

Enables or disables the secure boot function. Secure Boot requires all the applications that are running during the booting process to be pre-signed with valid digital certificates. This way, the system knows all the files being loaded before Windows 8 loads and gets to the login screen have not been tampered with. (Default: Enabled)

☞ **Secure Boot Mode**

Allows you to configure the secure boot mode. (Default: Standard)

▶ **Key Management**

This section provides you with configuration options for secure boot key management.

## 2-4 Boot

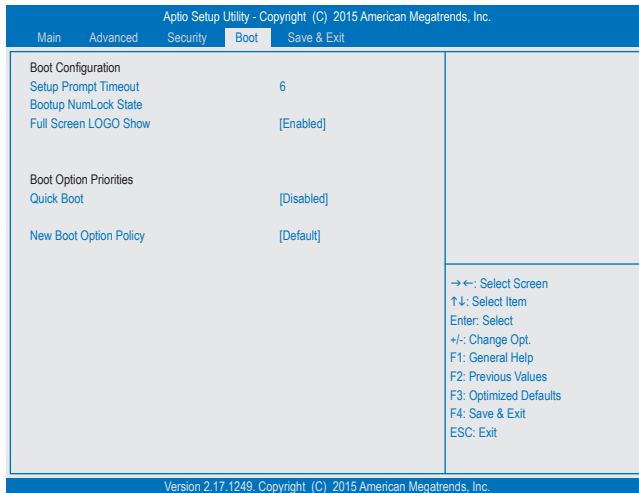

☞ **Setup Prompt Timeout**

Allows you to configure the number of seconds to stay in BIOS setup prompt screen. (Default: 6)

☞ **Bootup NumLock State**

Enables or disables Numlock feature on the numeric keypad of the keyboard after the POST. (Default: On)

☞ **Full Screen LOGO Show**

Allows you to determine whether to display the GIGABYTE Logo at system startup. **Disabled** skips the GIGABYTE Logo when the system starts up. (Default: Enabled)

☞ **Fast Boot**

Enables or disables Fast Boot to shorten the OS boot process. (Default: Disabled)

### ☞ **SATA Support**

- ▶▶ All Sata Devices All SATA devices are functional in the operating system and during the POST. (Default)
- ▶▶ Last Boot HDD Only Except for the previous boot drive, all SATA devices are disabled before the OS boot process completes.

This item is configurable only when **Fast Boot** is set to **Enabled**.

### ☞ **VGA Support**

Allows you to select which type of operating system to boot.

- ▶▶ Auto Enables legacy option ROM only.
- ▶▶ EFI Driver Enables EFI option ROM. (Default)

This item is configurable only when **Fast Boot** is set to **Enabled**.

### ☞ **USB Support**

- ▶▶ Disabled All USB devices are disabled before the OS boot process completes.
- ▶▶ Full Initial All USB devices are functional in the operating system and during the POST.
- ▶▶ Partial Initial Part of the USB devices are disabled before the OS boot process completes. (Default)

This item is configurable only when **Fast Boot** is set to **Enabled**.

### ☞ **PS2 Devices Support**

- ▶▶ Disabled All PS/2 devices are disabled before the OS boot process completes.
- ▶▶ Enabled All PS/2 devices are functional in the operating system and during the POST. (Default)

This item is configurable only when **Fast Boot** is set to **Enabled**.

### ☞ **NetWork Stack Driver Support**

- ▶▶ Disabled Disables booting from the network. (Default)
- ▶▶ Enabled Enables booting from the network.

This item is configurable only when **Fast Boot** is set to **Enabled**.

### ☞ **Boot Option #1/2/3**

Specifies the overall boot order from the available devices. For example, you can set hard drive as the first priority (**Boot Option #1**) and DVD ROM drive as the second priority (**Boot Option #2**). The list only displays the device with the highest priority for a specific type. For example, only hard drive defined as the first priority on the **Hard Drive BBS Priorities** submenu will be presented here.

Removable storage devices that support GPT format will be prefixed with "UEFI:" string on the boot device list. To boot from an operating system that supports GPT partitioning, select the device prefixed with "UEFI:" string.

Or if you want to install an operating system that supports GPT partitioning such as Windows 7 64-bit, select the optical drive that contains the Windows 7 64-bit installation disk and is prefixed with "UEFI:" string.

### ☞ **Hard Drive/CD/DVD ROM Drive/Floppy Drive/Network Device BBS Priorities**

Specifies the boot order for a specific device type, such as hard drives, optical drives, floppy disk drives, and devices that support Boot from LAN function, etc. Press <Enter> on this item to enter the submenu that presents the devices of the same type that are connected. This item is present only if at least one device for this type is installed.

### ☞ **New Boot Option Policy**

Allows you to determine whether to change the boot order when a new device is added.

- ▶▶ Dedault Keeps the previous boot order settings. (Default)
- ▶▶ Place First Set the newly added device as the first boot device.
- ▶▶ Place Last Set the newly added device as the last boot device.

## 2-5 Save & Exit

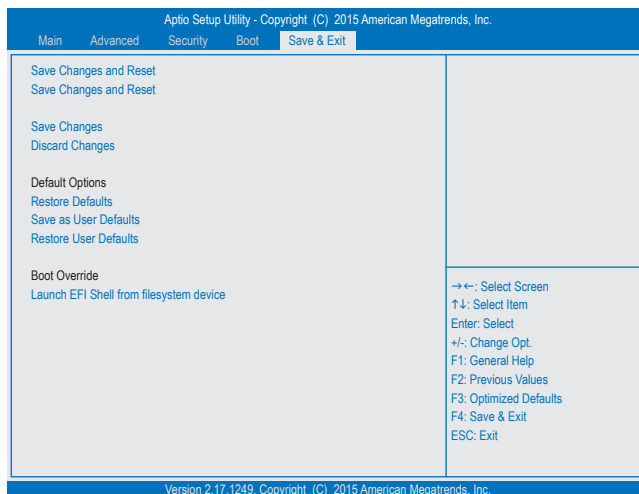

- ☞ **Save Changes and Reset**  
Press <Enter> on this item and select **Yes**. This saves the changes to the CMOS and exits the BIOS Setup program. Select **No** or press <Esc> to return to the BIOS Setup Main Menu.
- ☞ **Discard Changes and Reset**  
Press <Enter> on this item and select **Yes**. This exits the BIOS Setup without saving the changes made in BIOS Setup to the CMOS. Select **No** or press <Esc> to return to the BIOS Setup Main Menu.
- ☞ **Save Changes**  
Press <Enter> on this item and select **Yes** to save the changes to the CMOS. Select **No** or press <Esc> to return to the BIOS Setup Main Menu.
- ☞ **Discard Changes**  
Press <Enter> on this item and select **Yes** to cancel the BIOS changes. Select **No** or press <Esc> to return to the BIOS Setup Main Menu.
- ☞ **Restore Defaults**  
Press <Enter> on this item and select **Yes** to load the BIOS factory default settings. The BIOS defaults settings help the system to operate in optimum state. Always load the Optimized defaults after updating the BIOS or after clearing the CMOS values.
- ☞ **Save as User Defaults**  
Save to current BIOS settings as user-defined default settings.
- ☞ **Restore User Defaults**  
Load the user-define default settings for all BIOS options.
- ☞ **Boot Override**  
Allows you to select a device to boot immediately. Press <Enter> on the device you select and select **Yes** to confirm. Your system will restart automatically and boot from that device.
- ☞ **Launch EFI Shell from filesystem device**  
Allows you to launch the EFI Shell application (shell.efi) from one of the available filesystem devices. Press <Enter> on this option and the system will restart to the EFI Shell screen automatically.



## Chapter 3 Appendix

### Drivers Installation



- Before installing the drivers, first install the operating system. (The following instructions use Windows 8.1 as the example operating system.)
- After installing the operating system, insert the motherboard driver disk into your optical drive. Click on the message "Tap to choose what happens with this disc" on the top-right corner of the screen and select "Run **Run.exe**." (Or go to My Computer, double-click the optical drive and execute the **Run.exe** program.)

"Xpress Install" will automatically scan your system and then list all of the drivers that are recommended to install. You can click the **Xpress Install** button and "Xpress Install" will install all of the selected drivers. Or click the arrow  icon to individually install the drivers you need.

# Regulatory Statements

## **Regulatory Notices**

This document must not be copied without our written permission, and the contents there of must not be imparted to a third party nor be used for any unauthorized purpose.

Contravention will be prosecuted. We believe that the information contained herein was accurate in all respects at the time of printing. GIGABYTE cannot, however, assume any responsibility for errors or omissions in this text. Also note that the information in this document is subject to change without notice and should not be construed as a commitment by GIGABYTE.

## **Our Commitment to Preserving the Environment**

In addition to high-efficiency performance, all GIGABYTE motherboards fulfill European Union regulations for RoHS (Restriction of Certain Hazardous Substances in Electrical and Electronic Equipment) and WEEE (Waste Electrical and Electronic Equipment) environmental directives, as well as most major worldwide safety requirements. To prevent releases of harmful substances into the environment and to maximize the use of our natural resources, GIGABYTE provides the following information on how you can responsibly recycle or reuse most of the materials in your "end of life" product.

## **Restriction of Hazardous Substances (RoHS) Directive Statement**

GIGABYTE products have not intended to add and safe from hazardous substances (Cd, Pb, Hg, Cr+6, PBDE and PBB). The parts and components have been carefully selected to meet RoHS requirement. Moreover, we at GIGABYTE are continuing our efforts to develop products that do not use internationally banned toxic chemicals.

## **Waste Electrical & Electronic Equipment (WEEE) Directive Statement**

GIGABYTE will fulfill the national laws as interpreted from the 2002/96/EC WEEE (Waste Electrical and Electronic Equipment) directive. The WEEE Directive specifies the treatment, collection, recycling and disposal of electric and electronic devices and their components. Under the Directive, used equipment must be marked, collected separately, and disposed of properly.

## **WEEE Symbol Statement**



The symbol shown below is on the product or on its packaging, which indicates that this product must not be disposed of with other waste. Instead, the device should be taken to the waste collection centers for activation of the treatment, collection, recycling and disposal procedure. The separate collection and recycling of your waste equipment at the time of disposal will help to conserve natural resources and ensure that it is recycled in a manner that protects human health and the environment.

For more information about where you can drop off your waste equipment for recycling, please contact your local government office, your household waste disposal service or where you purchased the product for details of environmentally safe recycling.

- ◆ When your electrical or electronic equipment is no longer useful to you, "take it back" to your local or regional waste collection administration for recycling.
- ◆ If you need further assistance in recycling, reusing in your "end of life" product, you may contact us at the Customer Care number listed in your product's user's manual and we will be glad to help you with your effort.

Finally, we suggest that you practice other environmentally friendly actions by understanding and using the energy-saving features of this product (where applicable), recycling the inner and outer packaging (including shipping containers) this product was delivered in, and by disposing of or recycling used batteries properly. With your help, we can reduce the amount of natural resources needed to produce electrical and electronic equipment, minimize the use of landfills for the disposal of "end of life" products, and generally improve our quality of life by ensuring that potentially hazardous substances are not released into the environment and are disposed of properly.

### **FCC Notice (U.S.A. Only)**

This equipment has been tested and found to comply with the limits for a Class B digital device, pursuant to Part 15 of the FCC Rules. These limits are designed to provide reasonable protection against harmful interference in a residential installation. This equipment generates, uses, and can radiate radio frequency energy and, if not installed and used in accordance with the instructions, may cause harmful interference to radio communications. However, there is no guarantee that interference will not occur in a particular installation. If this equipment does cause harmful interference to radio or television reception, which can be determined by turning the equipment off and on, the user is encouraged to try to correct the interference by one or more of the following measures:

- ◆ Reorient or relocate the receiving antenna.
- ◆ Increase the separation between the equipment and receiver.
- ◆ Connect the equipment into an outlet on a circuit different from that to which the receiver is connected.
- ◆ Consult a dealer or experienced TV/radio technician for help.

### **Canada, Industry Canada (IC) Notices / Canada, avis d'Industry Canada (IC)**

- ◆ This Class B digital apparatus complies with Canadian ICES-003 and RSS-210.
- ◆ Operation is subject to the following two conditions: (1) this device may not cause interference, and (2) this device must accept any interference, including interference that may cause undesired operation of the device.
- ◆ Cet appareil numérique de classe B est conforme aux normes canadiennes ICES-003 et RSS-210.
- ◆ Son fonctionnement est soumis aux deux conditions suivantes : (1) cet appareil ne doit pas causer d'interférence et (2) cet appareil doit accepter toute interférence, notamment les interférences qui peuvent affecter son fonctionnement.



## Contact Us

**GIGA-BYTE TECHNOLOGY CO., LTD.**

Address: No.6, Baoqiang Rd., Xindian Dist., New Taipei City 231, Taiwan

TEL: +886-2-8912-4000, FAX: +886-2-8912-4005

Tech. and Non-Tech. Support (Sales/Marketing) : <http://esupport.gigabyte.com>

WEB address (English): <http://www.gigabyte.com>

WEB address (Chinese): <http://www.gigabyte.tw>

- **GIGABYTE eSupport**

To submit a technical or non-technical (Sales/Marketing) question, please link to:  
<http://esupport.gigabyte.com>

The screenshot shows the GIGABYTE eSupport website. At the top left is the GIGABYTE logo. To the right is the 'eSupport' logo. Below these are navigation icons for 'Downloads', 'FAQ', and 'Warranty'. A 'Sign in with' section features social media icons for Facebook, Google+, and a generic user icon. Below this is the 'GIGABYTE Passport' login form, which includes fields for 'E-mail' and 'Password', a 'Login' button, and a link for 'forget password?'. A small note at the bottom of the page reads: 'All intellectual property rights, including without limitation to copyright and trademark of this work and its derivative works, are the property of, or are licensed to, GIGA-BYTE TECHNOLOGY CO., LTD. Any unauthorized use is strictly prohibited.'