

GA-G41M-Combo

User's Manual

Rev. 2002

12ME-G41MC-2002R



To reduce the impacts on global warming, the packaging materials of this product are recyclable and reusable. GIGABYTE works with you to protect the environment.

Declaration of Conformity

We, Manufacturer/Importer,

G.B.T. Technology Trading GmbH

Address: Bullenkoppel 16, 22047 Hamburg, Germany

Declare that the product

Product Type: **Motherboard**

Product Name: **GA-G41M-Combo**

conforms with the essential requirements of the following directives:

- EMC Directive 2004/108/EC (until 2016/04/19), 2014/530/EU (after 2016/04/20):**
 - Conduction & Radiated Emissions: EN 55022:2010/AC2011
 - Immunity: EN 55024:2010
 - Power-line harmonics: EN 61000-3-2:2006+A2:2009
 - Power-line flicker: EN 61000-3-3:2013

- Low Voltage Directive 2006/95/EC (until 2016/04/19), 2014/35/EU (after 2016/04/20):**
 - Safety: EN60950-1:2006+A11:2009+A12:2011+A2:2013

- RoHS Directive 2011/65/EU**
 - Restriction of use of certain substances in electronic equipment: This product does not contain any of the restricted substances listed in Annex II, in concentrations and applications banned by the directive.

- CE marking**



Signature: Timmy Huang

(Name)

Date: Jun 12, 2014

Name:

Timmy Huang

DECLARATION OF CONFORMITY

Per FCC Part 2 Section 2.1077(a)



Responsible Party Name: G.B.T. INC. (U.S.A)

Address: 17358 Railroad Street

City of Industry, CA 91748

Phone/Fax No: (626) 854-9338/ (626) 854-9326

hereby declares that the product

Product Name: Motherboard

Model Number: GA-G41M-Combo

Conforms to the following specifications:

FCC Part 15, Subpart B, Section 15.107(a) and Section 15.109

(a), Class B Digital Device

Supplementary Information:

This device complies with part 15 of the FCC Rules. Operation is subject to the following two conditions: (1) This device may not cause harmful and (2) this device must accept any interference received, including that may cause undesired operation.

Representative Person's Name: ERIC LU

Signature: Eric Lu

Date: Jun 12, 2014

Copyright

© 2016 GIGA-BYTE TECHNOLOGY CO., LTD. All rights reserved.

The trademarks mentioned in this manual are legally registered to their respective owners.

Disclaimer

Information in this manual is protected by copyright laws and is the property of GIGABYTE. Changes to the specifications and features in this manual may be made by GIGABYTE without prior notice. No part of this manual may be reproduced, copied, translated, transmitted, or published in any form or by any means without GIGABYTE's prior written permission.

- In order to assist in the use of this product, carefully read the User's Manual.
- For product-related information, check on our website at: <http://www.gigabyte.com>

Identifying Your Motherboard Revision

The revision number on your motherboard looks like this: "REV: X.X." For example, "REV: 1.0" means the revision of the motherboard is 1.0. Check your motherboard revision before updating motherboard BIOS, drivers, or when looking for technical information.

Example:

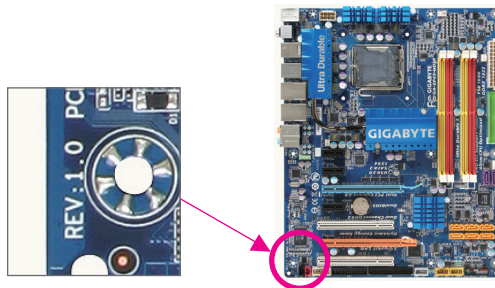
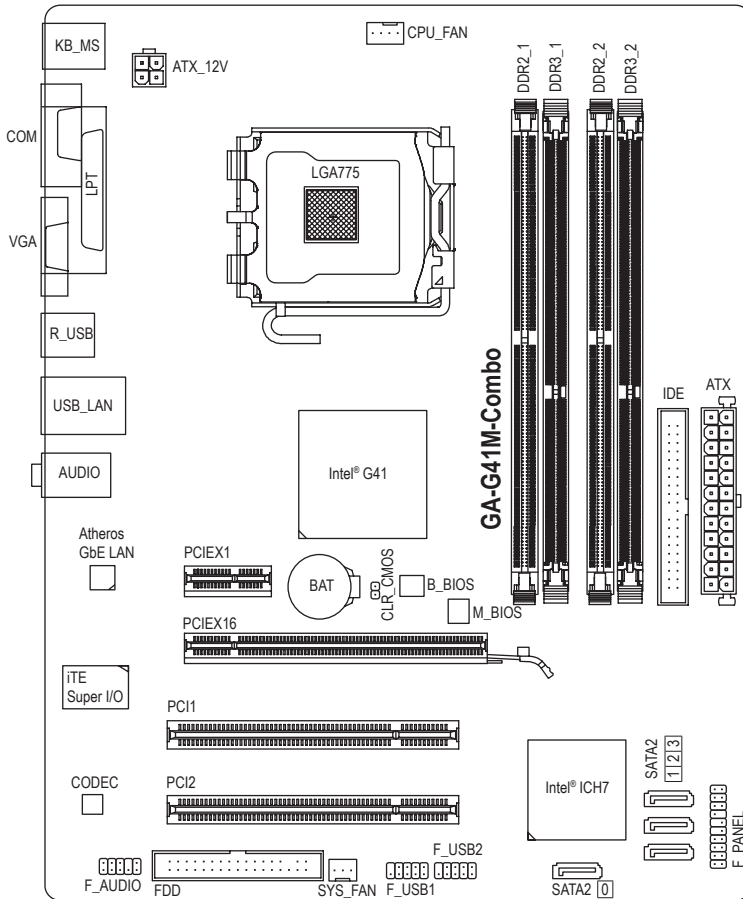

Table of Contents

GA-G41M-Combo Motherboard Layout	5
GA-G41M-Combo Motherboard Block Diagram.....	6
Chapter 1 Hardware Installation	7
1-1 Installation Precautions	7
1-2 Product Specifications.....	8
1-3 Installing the CPU	10
1-4 Installing the Memory	11
1-5 Installing an Expansion Card	11
1-6 Back Panel Connectors.....	12
1-7 Internal Connectors.....	13
Chapter 2 BIOS Setup	20
2-1 Startup Screen	20
2-2 The Main Menu	20
2-3 MB Intelligent Tweaker(M.I.T.).....	21
2-4 Standard CMOS Features.....	27
2-5 Advanced BIOS Features	28
2-6 Advanced Chipset Features.....	30
2-7 Integrated Peripherals.....	31
2-8 Power Management Setup.....	33
2-9 PnP/PCI Configurations	35
2-10 PC Health Status.....	35
2-11 Load Fail-Safe Defaults.....	36
2-12 Load Optimized Defaults.....	37
2-13 Set Supervisor/User Password	37
2-14 Save & Exit Setup	38
2-15 Exit Without Saving.....	38
Chapter 3 Drivers Installation.....	39
3-1 Installing Chipset Drivers	39
Regulatory Statements.....	40
Contact Us	44

GA-G41M-Combo Motherboard Layout



Box Contents

- GA-G41M-Combo motherboard
- Motherboard driver disk
- User's Manual
- One IDE cable
- Two SATA cables
- I/O Shield

The box contents above are for reference only and the actual items shall depend on the product package you obtain.
The box contents are subject to change without notice.

GA-G41M-Combo Motherboard Block Diagram

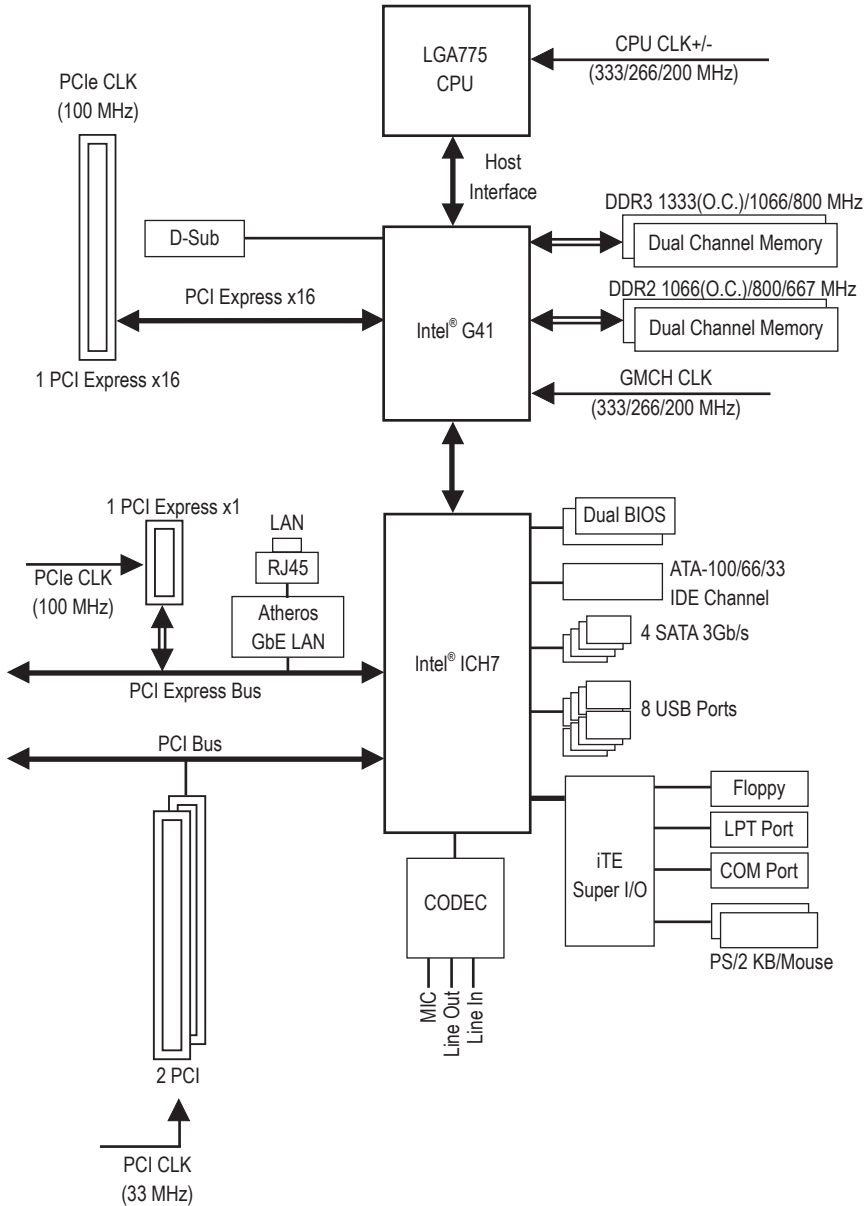











Chapter 1 Hardware Installation







1-1 Installation Precautions



The motherboard contains numerous delicate electronic circuits and components which can become damaged as a result of electrostatic discharge (ESD). Prior to installation, carefully read the user's manual and follow these procedures:

- Prior to installation, make sure the chassis is suitable for the motherboard.
- Prior to installation, do not remove or break motherboard S/N (Serial Number) sticker or warranty sticker provided by your dealer. These stickers are required for warranty validation.
- Always remove the AC power by unplugging the power cord from the power outlet before installing or removing the motherboard or other hardware components.
- When connecting hardware components to the internal connectors on the motherboard, make sure they are connected tightly and securely.
- When handling the motherboard, avoid touching any metal leads or connectors.
- It is best to wear an electrostatic discharge (ESD) wrist strap when handling electronic components such as a motherboard, CPU or memory. If you do not have an ESD wrist strap, keep your hands dry and first touch a metal object to eliminate static electricity.
- Prior to installing the motherboard, please have it on top of an antistatic pad or within an electrostatic shielding container.
- Before unplugging the power supply cable from the motherboard, make sure the power supply has been turned off.
- Before turning on the power, make sure the power supply voltage has been set according to the local voltage standard.
- Before using the product, please verify that all cables and power connectors of your hardware components are connected.
- To prevent damage to the motherboard, do not allow screws to come in contact with the motherboard circuit or its components.
- Make sure there are no leftover screws or metal components placed on the motherboard or within the computer casing.
- Do not place the computer system on an uneven surface.
- Do not place the computer system in a high-temperature environment.
- Turning on the computer power during the installation process can lead to damage to system components as well as physical harm to the user.
- If you are uncertain about any installation steps or have a problem related to the use of the product, please consult a certified computer technician.

1-2 Product Specifications

	CPU	<ul style="list-style-type: none"> ◆ Support for an Intel® Core™ 2 Extreme processor/Intel® Core™ 2 Quad processor/Intel® Core™ 2 Duo processor/Intel® Pentium® processor/Intel® Celeron® processor in the LGA775 package (Go to GIGABYTE's website for the latest CPU support list.) ◆ L2 cache varies with CPU
	Front Side Bus	<ul style="list-style-type: none"> ◆ 1333/1066/800 MHz FSB
	Chipset	<ul style="list-style-type: none"> ◆ North Bridge: Intel® G41 Express Chipset ◆ South Bridge: Intel® ICH7
	Memory	<ul style="list-style-type: none"> ◆ DDR3: <ul style="list-style-type: none"> - 2 x 1.5V DDR3 DIMM sockets supporting up to 4 GB of system memory - Support for DDR3 1333(O.C.)/1066/800 MHz memory modules ◆ DDR2: <ul style="list-style-type: none"> - 2 x 1.8V DDR2 DIMM sockets supporting up to 8 GB of system memory <ul style="list-style-type: none"> * Due to Windows 32-bit operating system limitation, when more than 4 GB of physical memory is installed, the actual memory size displayed will be less than 4 GB. - Support for DDR2 1066(O.C.)/800/667 MHz memory modules ◆ Dual channel memory architecture (Note: Mixed mode, populating DDR2 and DDR3 memory modules simultaneously is not supported. Go to GIGABYTE's website for the latest supported memory speeds and memory modules.)
	Onboard Graphics	<ul style="list-style-type: none"> ◆ North Bridge: <ul style="list-style-type: none"> - 1 x D-Sub port
	Audio	<ul style="list-style-type: none"> ◆ Realtek ALC887 codec ◆ High Definition Audio ◆ 2/4/5.1-channel
	LAN	<ul style="list-style-type: none"> ◆ Atheros GbE LAN chip (10/100/1000 Mbit)
	Expansion Slots	<ul style="list-style-type: none"> ◆ 1 x PCI Express x16 slot, running at x16 ◆ 1 x PCI Express x1 slot ◆ 2 x PCI slots
	Storage Interface	<ul style="list-style-type: none"> ◆ South Bridge: <ul style="list-style-type: none"> - 1 x IDE connector supporting ATA-100/66/33 and up to 2 IDE devices - 4 x SATA 3Gb/s connectors supporting up to 4 SATA 3Gb/s devices ◆ iTE I/O Controller Chip: <ul style="list-style-type: none"> - 1 x floppy disk drive connector supporting up to 1 floppy disk drive
	USB	<ul style="list-style-type: none"> ◆ South Bridge: <ul style="list-style-type: none"> - Up to 8 USB 2.0/1.1 ports (4 on the back panel, 4 via the USB brackets connected to the internal USB headers)
	Internal Connectors	<ul style="list-style-type: none"> ◆ 1 x 24-pin ATX main power connector ◆ 1 x 4-pin ATX 12V power connector ◆ 1 x floppy disk drive connector ◆ 1 x IDE connector

	Internal Connectors	<ul style="list-style-type: none"> ◆ 4 x SATA 3Gb/s connectors ◆ 1 x CPU fan header ◆ 1 x system fan header ◆ 1 x front panel header ◆ 1 x front panel audio header ◆ 2 x USB 2.0/1.1 headers ◆ 1 x clear CMOS jumper
	Back Panel Connectors	<ul style="list-style-type: none"> ◆ 1 x PS/2 keyboard port ◆ 1 x PS/2 mouse port ◆ 1 x parallel port ◆ 1 x serial port ◆ 1 x D-Sub port ◆ 4 x USB 2.0/1.1 ports ◆ 1 x RJ-45 port ◆ 3 x audio jacks (Line In/Line Out/Microphone)
	I/O Controller	<ul style="list-style-type: none"> ◆ iTE I/O Controller Chip
	Hardware Monitor	<ul style="list-style-type: none"> ◆ System voltage detection ◆ CPU temperature detection ◆ CPU/System fan speed detection ◆ CPU overheating warning ◆ CPU/System fan fail warning ◆ CPU fan speed control <ul style="list-style-type: none"> * Whether the CPU fan speed control function is supported will depend on the CPU cooler you install.
	BIOS	<ul style="list-style-type: none"> ◆ 2 x 8 Mbit flash ◆ Use of licensed AWARD BIOS ◆ Support for DualBIOS™ ◆ PnP 1.0a, DMI 2.0, SM BIOS 2.4, ACPI 1.0b
	Unique Features	<ul style="list-style-type: none"> ◆ Support for @BIOS ◆ Support for Q-Flash ◆ Support for Xpress BIOS Rescue ◆ Support for Download Center ◆ Support for Xpress Install ◆ Support for Xpress Recovery2 ◆ Support for EasyTune <ul style="list-style-type: none"> * Available functions in EasyTune may differ by motherboard model. ◆ Support for Easy Energy Saver <ul style="list-style-type: none"> * Due to the hardware limitation, you must install the Intel® Core™ 2 Extreme/Core™ 2 Quad/Core™ 2 Duo/Pentium Dual-Core/Celeron Dual-Core/Celeron 400 Series CPU to enable support for Easy Energy Saver. ◆ Support for SMART Recovery ◆ Support for Auto Green ◆ Support for ON/OFF Charge ◆ Support for Q-Share

 Bundled Software	◆ Norton Internet Security (OEM version)
 Operating System	◆ Support for Microsoft® Windows 7/Vista/XP
 Form Factor	◆ Micro ATX Form Factor; 24.4cm x 21.0cm

* GIGABYTE reserves the right to make any changes to the product specifications and product-related information without prior notice.

1-3 Installing the CPU



Read the following guidelines before you begin to install the CPU:

- Make sure that the motherboard supports the CPU.
(Go to GIGABYTE's website for the latest CPU support list.)
- Always turn off the computer and unplug the power cord from the power outlet before installing the CPU to prevent hardware damage.
- Locate the pin one of the CPU. The CPU cannot be inserted if oriented incorrectly. (Or you may locate the notches on both sides of the CPU and alignment keys on the CPU socket.)
- Apply an even and thin layer of thermal grease on the surface of the CPU.
- Do not turn on the computer if the CPU cooler is not installed, otherwise overheating and damage of the CPU may occur.
- Set the CPU host frequency in accordance with the CPU specifications. It is not recommended that the system bus frequency be set beyond hardware specifications since it does not meet the standard requirements for the peripherals. If you wish to set the frequency beyond the standard specifications, please do so according to your hardware specifications including the CPU, graphics card, memory, hard drive, etc.

Installing the CPU

Locate the alignment keys on the motherboard CPU socket and the notches on the CPU.

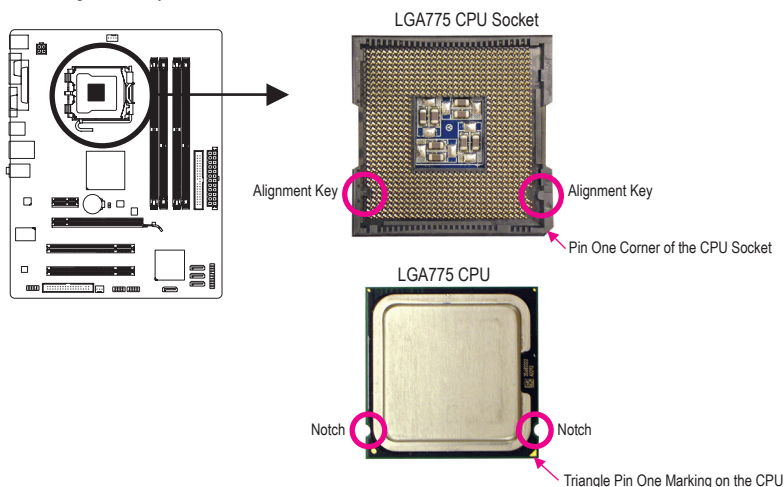

1-4 Installing the Memory



Read the following guidelines before you begin to install the memory:

- Make sure that the motherboard supports the memory. It is recommended that memory of the same capacity, brand, speed, and chips be used.
(Go to GIGABYTE's website for the latest supported memory speeds and memory modules.)
- Always turn off the computer and unplug the power cord from the power outlet before installing the memory to prevent hardware damage.
- Memory modules have a foolproof design. A memory module can be installed in only one direction. If you are unable to insert the memory, switch the direction.
- Populating DDR2 and DDR3 memory modules simultaneously is not supported. To ensure memory compatibility, be sure to use the memory modules on the memory support list at GIGABYTE's website.

Dual Channel Memory Configuration

This motherboard provides two DDR2 and two DDR3 memory sockets and supports Dual Channel Technology. The two DDR3 memory sockets (DDR3_1, DDR3_2) are divided into two channels and each channel has one memory socket as following:

Channel 0: DDR3_1

Channel 1: DDR3_2

The two DDR2 memory sockets (DDR2_1, DDR2_2) are divided into two channels and each channel has one memory socket as following:

Channel 0: DDR2_1

Channel 1: DDR2_2

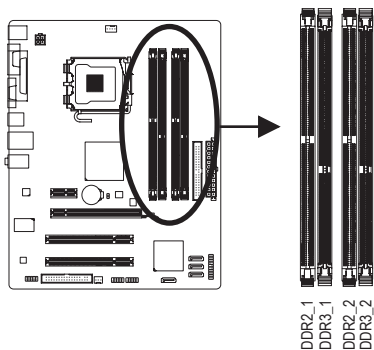

DDR3/DDR2 Dual Channel Memory Configuration:

Due to chipset limitations, read the following guidelines before installing the memory in Dual Channel mode.

1. Dual Channel mode cannot be enabled if only one DDR3/DDR2 memory module is installed.
2. When enabling Dual Channel mode with two memory modules, it is recommended that memory of the same capacity, brand, speed, and chips be used.

1-5 Installing an Expansion Card



Read the following guidelines before you begin to install an expansion card:

- Make sure the motherboard supports the expansion card. Carefully read the manual that came with your expansion card.
- Always turn off the computer and unplug the power cord from the power outlet before installing an expansion card to prevent hardware damage.

1-6 Back Panel Connectors

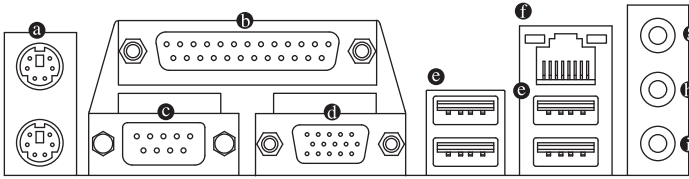

a PS/2 Keyboard and PS/2 Mouse Port

Use the upper port (green) to connect a PS/2 mouse and the lower port (purple) to connect a PS/2 keyboard.

b Parallel Port

Use the parallel port to connect devices such as a printer, scanner and etc. The parallel port is also called a printer port.

c Serial Port

Use the serial port to connect devices such as a mouse, modem or other peripherals.

d D-Sub Port

The D-Sub port supports a 15-pin D-Sub connector. Connect a monitor that supports D-Sub connection to this port.

e USB 2.0/1.1 Port

The USB port supports the USB 2.0/1.1 specification. Use this port for USB devices such as a USB keyboard/mouse, USB printer, USB flash drive and etc.

f RJ-45 LAN Port

The Gigabit Ethernet LAN port provides Internet connection at up to 1 Gbps data rate. The following describes the states of the LAN port LEDs.

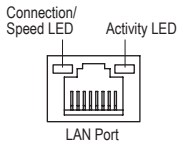

Connection/Speed LED:	
State	Description
Orange	1 Gbps data rate
Green	100 Mbps data rate
Off	10 Mbps data rate

Activity LED:	
State	Description
Blinking	Data transmission or receiving is occurring
Off	No data transmission or receiving is occurring

g Line In Jack (Blue)

The line in jack. Use this audio jack for line in devices such as an optical drive, walkman, etc.

h Line Out Jack (Green)

The line out jack. Use this audio jack for a headphone or 2-channel speaker. This jack can be used to connect front speakers in a 4/5.1-channel audio configuration.

i Mic In Jack (Pink)

The Mic in jack. Microphones must be connected to this jack.



- When removing the cable connected to a back panel connector, first remove the cable from your device and then remove it from the motherboard.
- When removing the cable, pull it straight out from the connector. Do not rock it side to side to prevent an electrical short inside the cable connector.

1-7 Internal Connectors

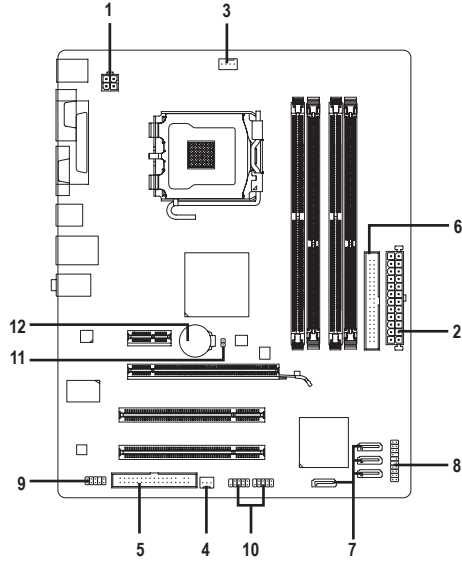

1) ATX_12V	7) SATA2 0/1/2/3
2) ATX	8) F_PANEL
3) CPU_FAN	9) F_AUDIO
4) SYS_FAN	10) F_USB1/F_USB2
5) FDD	11) CLR_CMOS
6) IDE	12) BAT



Read the following guidelines before connecting external devices:

- First make sure your devices are compliant with the connectors you wish to connect.
- Before installing the devices, be sure to turn off the devices and your computer. Unplug the power cord from the power outlet to prevent damage to the devices.
- After installing the device and before turning on the computer, make sure the device cable has been securely attached to the connector on the motherboard.

1/2) ATX_12V/ATX (2x2 12V Power Connector and 2x12 Main Power Connector)

With the use of the power connector, the power supply can supply enough stable power to all the components on the motherboard. Before connecting the power connector, first make sure the power supply is turned off and all devices are properly installed. The power connector possesses a foolproof design. Connect the power supply cable to the power connector in the correct orientation. The 12V power connector mainly supplies power to the CPU. If the 12V power connector is not connected, the computer will not start.



To meet expansion requirements, it is recommended that a power supply that can withstand high power consumption be used (500W or greater). If a power supply is used that does not provide the required power, the result can lead to an unstable or unbootable system.

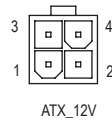
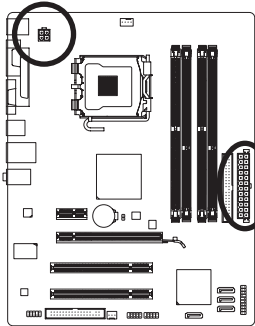

ATX_12V:

Pin No.	Definition
1	GND
2	GND
3	+12V
4	+12V

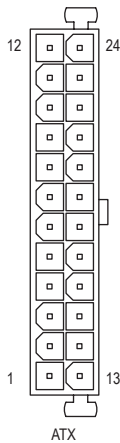

ATX:

Pin No.	Definition	Pin No.	Definition
1	3.3V	13	3.3V
2	3.3V	14	-12V
3	GND	15	GND
4	+5V	16	PS_ON (soft On/Off)
5	GND	17	GND
6	+5V	18	GND
7	GND	19	GND
8	Power Good	20	NC
9	5VSB (stand by +5V)	21	+5V
10	+12V	22	+5V
11	+12V (Only for 2x12-pin ATX)	23	+5V (Only for 2x12-pin ATX)
12	3.3V (Only for 2x12-pin ATX)	24	GND (Only for 2x12-pin ATX)

3/4) CPU_FAN/SYS_FAN (Fan Headers)

The motherboard has a 4-pin CPU fan header (CPU_FAN) and a 3-pin (SYS_FAN) system fan header. Most fan headers possess a foolproof insertion design. When connecting a fan cable, be sure to connect it in the correct orientation (the black connector wire is the ground wire). The motherboard supports CPU fan speed control, which requires the use of a CPU fan with fan speed control design. For optimum heat dissipation, it is recommended that a system fan be installed inside the chassis.

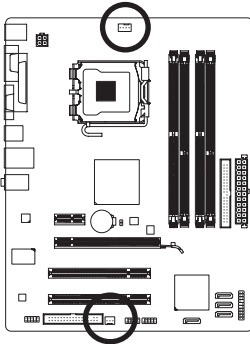

CPU_FAN



SYS_FAN

CPU_FAN:

Pin No.	Definition
1	GND
2	+12V
3	Sense
4	Speed Control

SYS_FAN:

Pin No.	Definition
1	GND
2	+12V
3	Sense



- Be sure to connect fan cables to the fan headers to prevent your CPU and system from overheating. Overheating may result in damage to the CPU or the system may hang.
- These fan headers are not configuration jumper blocks. Do not place a jumper cap on the headers.

5) FDD (Floppy Disk Drive Connector)

This connector is used to connect a floppy disk drive. The types of floppy disk drives supported are: 360 KB, 720 KB, 1.2 MB, 1.44 MB, and 2.88 MB. Before connecting a floppy disk drive, be sure to locate pin 1 of the connector and the floppy disk drive cable. The pin 1 of the cable is typically designated by a stripe of different color. For purchasing the optional floppy disk drive cable, please contact the local dealer.

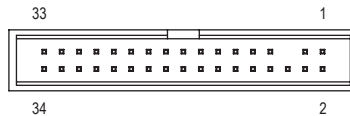
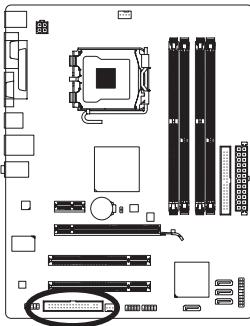

6) IDE (IDE Connector)

The IDE connector supports up to two IDE devices such as hard drives and optical drives. Before attaching the IDE cable, locate the foolproof groove on the connector. If you wish to connect two IDE devices, remember to set the jumpers and the cabling according to the role of the IDE devices (for example, master or slave). (For information about configuring master/slave settings for the IDE devices, read the instructions from the device manufacturers.)

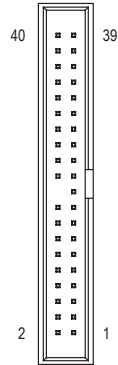
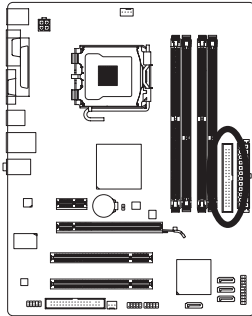

7) SATA2 0/1/2/3 (SATA 3Gb/s Connectors)

The SATA connectors conform to SATA 3Gb/s standard and are compatible with SATA 1.5Gb/s standard. Each SATA connector supports a single SATA device.

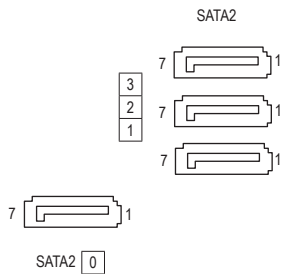
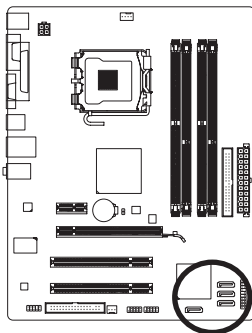

Pin No.	Definition
1	GND
2	TXP
3	TXN
4	GND
5	RXN
6	RXP
7	GND

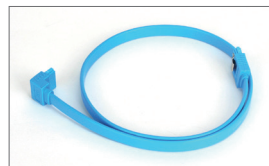

Please connect the L-shaped end of the SATA cable to your SATA hard drive.

8) F_PANEL (Front Panel Header)

Connect the power switch, reset switch, speaker and system status indicator on the chassis front panel to this header according to the pin assignments below. Note the positive and negative pins before connecting the cables.

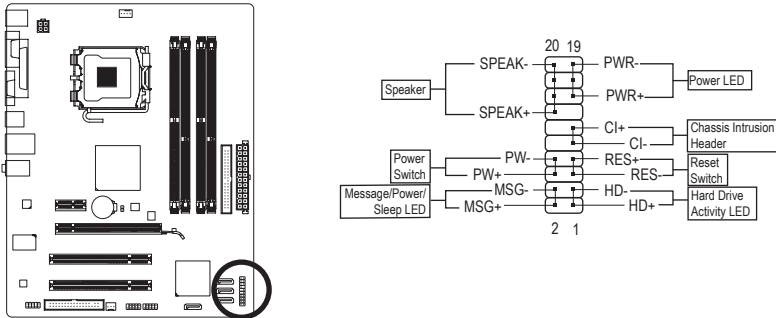

- **MSG/PWR (Message/Power/Sleep LED):**

System Status	LED
S0	On
S1	Blinking
S3/S4/S5	Off

Connects to the power status indicator on the chassis front panel. The LED is on when the system is operating. The LED keeps blinking when the system is in S1 sleep state. The LED is off when the system is in S3/S4 sleep state or powered off (S5).

- **PW (Power Switch):**

Connects to the power switch on the chassis front panel. You may configure the way to turn off your system using the power switch (refer to Chapter 2, "BIOS Setup," "Power Management Setup," for more information).

- **SPEAK (Speaker):**

Connects to the speaker on the chassis front panel. The system reports system startup status by issuing a beep code. One single short beep will be heard if no problem is detected at system startup. If a problem is detected, the BIOS may issue beeps in different patterns to indicate the problem.

- **HD (Hard Drive Activity LED)**

Connects to the hard drive activity LED on the chassis front panel. The LED is on when the hard drive is reading or writing data.

- **RES (Reset Switch):**

Connects to the reset switch on the chassis front panel. Press the reset switch to restart the computer if the computer freezes and fails to perform a normal restart.

- **CI (Chassis Intrusion Header):**

Connects to the chassis intrusion switch/sensor on the chassis that can detect if the chassis cover has been removed. This function requires a chassis with a chassis intrusion switch/sensor.



The front panel design may differ by chassis. A front panel module mainly consists of power switch, reset switch, power LED, hard drive activity LED, speaker and etc. When connecting your chassis front panel module to this header, make sure the wire assignments and the pin assignments are matched correctly.

9) F_AUDIO (Front Panel Audio Header)

The front panel audio header supports Intel High Definition audio (HD) and AC'97 audio. You may connect your chassis front panel audio module to this header. Make sure the wire assignments of the module connector match the pin assignments of the motherboard header. Incorrect connection between the module connector and the motherboard header will make the device unable to work or even damage it.

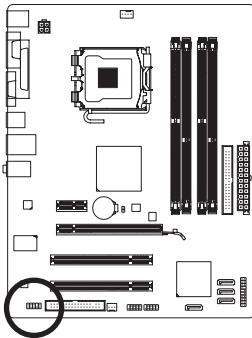

For HD Front Panel Audio:

Pin No.	Definition
1	MIC2_L
2	GND
3	MIC2_R
4	-ACZ_DET
5	LINE2_R
6	GND
7	FAUDIO_JD
8	No Pin
9	LINE2_L
10	GND

For AC'97 Front Panel Audio:

Pin No.	Definition
1	MIC
2	GND
3	MIC Power
4	NC
5	Line Out (R)
6	NC
7	NC
8	No Pin
9	Line Out (L)
10	NC



- The front panel audio header supports HD audio by default.
- Audio signals will be present on both of the front and back panel audio connections simultaneously.
- Some chassis provide a front panel audio module that has separated connectors on each wire instead of a single plug. For information about connecting the front panel audio module that has different wire assignments, please contact the chassis manufacturer.

10) F_USB1/F_USB2 (USB Headers)

The headers conform to USB 2.0/1.1 specification. Each USB header can provide two USB ports via an optional USB bracket. For purchasing the optional USB bracket, please contact the local dealer.

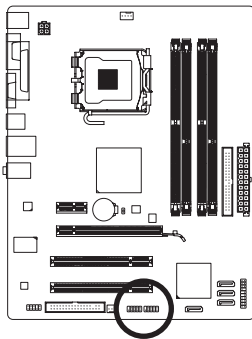

Pin No.	Definition
1	Power (5V)
2	Power (5V)
3	USB DX-
4	USB DY-
5	USB DX+
6	USB DY+
7	GND
8	GND
9	No Pin
10	NC



- Do not plug the IEEE 1394 bracket (2x5-pin) cable into the USB header.
- Prior to installing the USB bracket, be sure to turn off your computer and unplug the power cord from the power outlet to prevent damage to the USB bracket.

11) CLR_CMOS (Clear CMOS Jumper)

Use this jumper to clear the CMOS values (e.g. date information and BIOS configurations) and reset the CMOS values to factory defaults. To clear the CMOS values, place use a metal object like a screwdriver to touch the two pins for a few seconds.

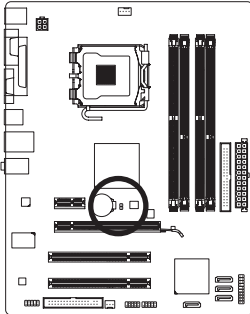

 Open: Normal

 Short: Clear CMOS Values



- Always turn off your computer and unplug the power cord from the power outlet before clearing the CMOS values.
- After system restart, go to BIOS Setup to load factory defaults (select **Load Optimized Defaults**) or manually configure the BIOS settings (refer to Chapter 2, "BIOS Setup," for BIOS configurations).

12) BAT (Battery)

The battery provides power to keep the values (such as BIOS configurations, date, and time information) in the CMOS when the computer is turned off. Replace the battery when the battery voltage drops to a low level, or the CMOS values may not be accurate or may be lost.

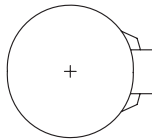
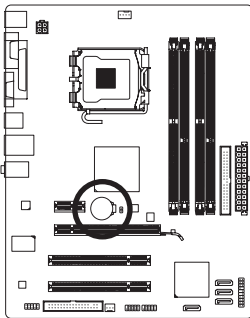

You may clear the CMOS values by removing the battery:

1. Turn off your computer and unplug the power cord.
2. Gently remove the battery from the battery holder and wait for one minute. (Or use a metal object like a screwdriver to touch the positive and negative terminals of the battery holder, making them short for 5 seconds.)
3. Replace the battery.
4. Plug in the power cord and restart your computer.



- Always turn off your computer and unplug the power cord before replacing the battery.
- Replace the battery with an equivalent one. Danger of explosion if the battery is replaced with an incorrect model.
- Contact the place of purchase or local dealer if you are not able to replace the battery by yourself or uncertain about the battery model.
- When installing the battery, note the orientation of the positive side (+) and the negative side (-) of the battery (the positive side should face up).
- Used batteries must be handled in accordance with local environmental regulations.

Chapter 2 BIOS Setup

To access the BIOS Setup program, press the <Delete> key during the POST when the power is turned on. To see more advanced BIOS Setup menu options, you can press <Ctrl> + <F1> in the main menu of the BIOS Setup program.

To upgrade the BIOS, use either the GIGABYTE Q-Flash or @BIOS utility.

- Q-Flash allows the user to quickly and easily upgrade or back up BIOS without entering the operating system.
- @BIOS is a Windows-based utility that searches and downloads the latest version of BIOS from the Internet and updates the BIOS.



- Because BIOS flashing is potentially risky, if you do not encounter problems using the current version of BIOS, it is recommended that you not flash the BIOS. To flash the BIOS, do it with caution. Inadequate BIOS flashing may result in system malfunction.
- It is recommended that you not alter the default settings (unless you need to) to prevent system instability or other unexpected results. Inadequately altering the settings may result in system's failure to boot. If this occurs, try to clear the CMOS values and reset the board to default values. (Refer to the "Load Optimized Defaults" section in this chapter or introductions of the battery/clear CMOS jumper in Chapter 1 for how to clear the CMOS values.)

2-1 Startup Screen

The following screens may appear when the computer boots.

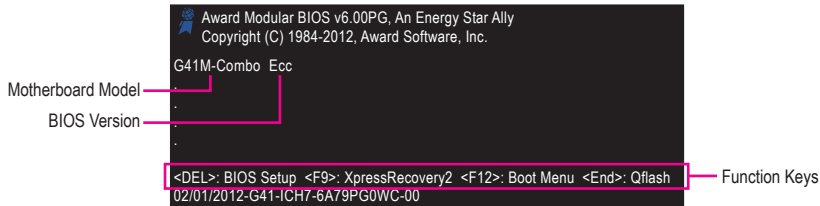

2-2 The Main Menu

Once you enter the BIOS Setup program, the Main Menu (as shown below) appears on the screen. Use arrow keys to move among the items and press <Enter> to accept or enter a sub-menu.

(Sample BIOS Version: Ecc)

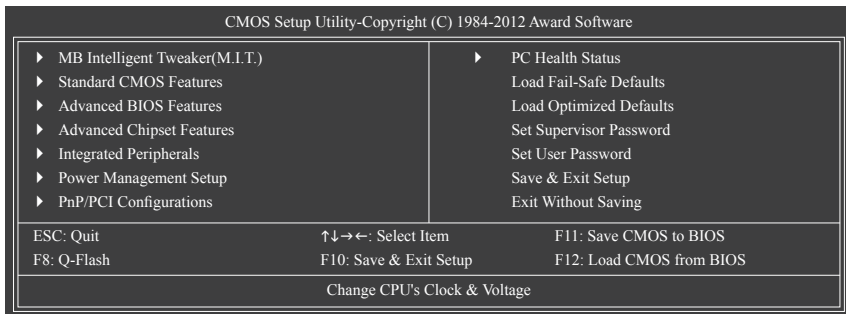



- If you do not find the settings you want in the Main Menu or a submenu, press <Ctrl>+<F1> to access more advanced options.
- When the system is not stable as usual, select the **Load Optimized Defaults** item to set your system to its defaults.
- The BIOS Setup menus described in this chapter are for reference only and may differ by BIOS version.

■ The Functions of the <F11> and <F12> keys (For the Main Menu Only)

▶ F11: Save CMOS to BIOS

This function allows you to save the current BIOS settings to a profile. You can create up to 8 profiles (Profile 1-8) and name each profile. First enter the profile name (to erase the default profile name, use the SPACE key) and then press <Enter> to complete.

▶ F12: Load CMOS from BIOS

If your system becomes unstable and you have loaded the BIOS default settings, you can use this function to load the BIOS settings from a profile created before, without the hassles of reconfiguring the BIOS settings. First select the profile you wish to load, then press <Enter> to complete.

2-3 MB Intelligent Tweaker(M.I.T.)

CMOS Setup Utility-Copyright (C) 1984-2012 Award Software
MB Intelligent Tweaker(M.I.T.)

Robust Graphics Booster	[Auto]	
CPU Clock Ratio ^(Note)		[12X]
Fine CPU Clock Ratio ^(Note)	[+0.0]	
CPU Frequency		2.40GHz (200x12)
***** Clock Chip Control *****		
>>>>> Standard Clock Control		
CPU Host Clock Control	[Disabled]	
x CPU Host Frequency (Mhz)		200
PCI Express Frequency (Mhz)		[Auto]
>>>>> Advanced Clock Control		
***** DRAM Performance Control *****		
Performance Enhance		[Standard]
(G)MCH Frequency Latch	[Auto]	
System Memory Multiplier (SPD)		[Auto]
Memory Frequency (Mhz) 1333		800
DRAM Timing Selectable (SPD)	[Auto]	
>>>>> Standard Timing Control		

↑↓→←: Move Enter: Select +/-/PU/PD: Value F10: Save ESC: Exit F1: General Help
F5: Previous Values F6: Fail-Safe Defaults F7: Optimized Defaults

(Note) This item appears only if you install a CPU that supports this feature.

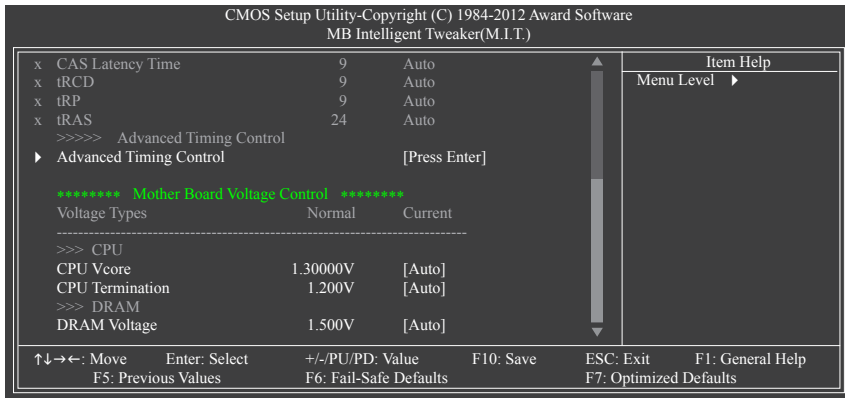

Whether the system will work stably with the overclock/overvoltage settings you made is dependent on your overall system configurations. Incorrectly doing overclock/overvoltage may result in damage to CPU, chipset, or memory and reduce the useful life of these components. This page is for advanced users only and we recommend you not to alter the default settings to prevent system instability or other unexpected results. (Inadequately altering the settings may result in system's failure to boot. If this occurs, clear the CMOS values and reset the board to default values.)

⊞ Robust Graphics Booster

Robust Graphics Booster (R.G.B.) helps to enhance the performance of the graphics chip and memory. **Auto** allows the BIOS to automatically set the R.G.B. mode based on system configurations. Options are: Auto (default), Fast, Turbo.

⊞ CPU Clock Ratio ^(Note)

Allows you to alter the clock ratio for the installed CPU.
The item is present only if a CPU with unlocked clock ratio is installed.

⊞ Fine CPU Clock Ratio ^(Note)

Allows you to increase clock ratio by 0.5 for the installed CPU.
The item is present only if a CPU with unlocked clock ratio is installed.

⊞ CPU Frequency

Displays the current operating CPU frequency.

***** Clock Chip Control *****

>>>>> Standard Clock Control

⊞ CPU Host Clock Control

Enables or disables the control of CPU host clock. **Enabled** will allow the **CPU Host Frequency** item below to be configurable. Note: If your system fails to boot after overclocking, please wait for 20 seconds to allow for automated system reboot, or clear the CMOS values to reset the board to default values. (Default: Disabled)

(Note) This item appears only if you install a CPU that supports this feature.

☞ **CPU Host Frequency (Mhz)**

Allows you to manually set the CPU host frequency. The adjustable range is from 100 MHz to 1200 MHz. This item is configurable only if the **CPU Host Clock Control** option is enabled.

Important: It is highly recommended that the CPU frequency be set in accordance with the CPU specifications.

☞ **PCI Express Frequency (Mhz)**

Allows you to manually set the PCIe clock frequency. The adjustable range is from 90 MHz to 150 MHz. **Auto** sets the PCIe clock frequency to standard 100 MHz. (Default: Auto)

***** **DRAM Performance Control** *****

☞ **Performance Enhance**

Allows the system to operate at three different performance levels.

- ▶▶ Standard Lets the system operate at its basic performance level. (Default)
- ▶▶ Turbo Lets the system operate at its good performance level.
- ▶▶ Extreme Lets the system operate at its best performance level.

☞ **(G)MCH Frequency Latch**

Allows you to fix the chipset frequency at system bootup. Options for adjusting memory multiplier below may differ according to the fixed frequency. Options are: Auto (default), 200MHz, 266MHz, 333MHz.

☞ **System Memory Multiplier (SPD)**

Allows you to set the system memory multiplier. Options are dependent on CPU FSB and the **(G)MCH Frequency Latch** settings. **Auto** sets memory multiplier according to memory SPD data. (Default: Auto)

☞ **Memory Frequency (Mhz)**

The first memory frequency value is the normal operating frequency of the memory being used; the second is the memory frequency that is automatically adjusted according to the **System Memory Multiplier** settings.

☞ **DRAM Timing Selectable (SPD)**

Manual allows all DRAM timing control items below to be configurable. Options are: Auto (default), Manual.

>>>> **Standard Timing Control**

☞ **CAS Latency Time**

Options are: Auto (default), 4~11.

☞ **tRCD**

Options are: Auto (default), 1~15.

☞ **tRP**

Options are: Auto (default), 1~15.

☞ **tRAS**

Options are: Auto (default), 1~63.

☞ **Static tRead Value**

Options are: Auto (default), 1~15.

☞ **tRD Phase0 Adjustment**

Options are: Auto (default), 0-Normal, 1-Advanced.

☞ **tRD Phase1 Adjustment**

Options are: Auto (default), 0-Normal, 1-Advanced.

☞ **tRD Phase2 Adjustment**

Options are: Auto (default), 0-Normal, 1-Advanced.

☞ **tRD Phase3 Adjustment**

Options are: Auto (default), 0-Normal, 1-Advanced.

☞ **Trd2rd(Different Rank)**

Options are: Auto (default), 1~15.

☞ **Twr2wr(Different Rank)**

Options are: Auto (default), 1~15.

☞ **Twr2rd(Different Rank)**

Options are: Auto (default), 1~15.

☞ **Trd2wr(Same/Diff Rank)**

Options are: Auto (default), 1~15.

☞ **DIMM1 Clock Skew Control**

Options are: Auto (default), +800ps~-700ps.

☞ **DIMM2 Clock Skew Control**

Options are: Auto (default), +800ps~-700ps.

☞ **DDR Write Leveling**

Allows you to determine whether to fine-tune memory parameters to enhance memory compatibility.

- ▶▶ Auto Lets the BIOS decide whether to enable this function. (Default)
- ▶▶ Enabled Enables this function to enhance memory compatibility.
- ▶▶ Disabled Disables this function.

☞ **DDR Write Training**

Allows you to determine whether to fine-tune memory parameters to enhance memory compatibility.

- ▶▶ Auto Lets the BIOS decide whether to enable this function. (Default)
- ▶▶ Enabled Enables this function to enhance memory compatibility.
- ▶▶ Disabled Disables this function.

☞ Channel A/B Driving Settings

CMOS Setup Utility-Copyright (C) 1984-2012 Award Software		
Channel A/B Driving Settings		
x	Driving Strength Profile	Auto
x	Data Driving Pull-Up Level	Auto
x	Cmd Driving Pull-Up Level	Auto
x	Ctrl Driving Pull-Up Level	Auto
x	Clk Driving Pull-Up Level	Auto
x	Data Driving Pull-Down Level	Auto
x	Cmd Driving Pull-Down Level	Auto
x	Ctrl Driving Pull-Down Level	Auto
x	Clk Driving Pull-Down Level	Auto
↑↓→←: Move		Enter: Select
F5: Previous Values		+/-/PU/PD: Value
		F6: Fail-Safe Defaults
		F10: Save
		ESC: Exit
		F1: General Help
		F7: Optimized Defaults

☞ Driving Strength Profile

Options are: Auto (default).

☞ Data Driving Pull-Up Level

Options are: Auto (default), +8~-7.

☞ Cmd Driving Pull-Up Level

Options are: Auto (default), +8~-7.

☞ Ctrl Driving Pull-Up Level

Options are: Auto (default), +8~-7.

☞ Clk Driving Pull-Up Level

Options are: Auto (default), +8~-7.

☞ Data Driving Pull-Down Level

Options are: Auto (default), +8~-7.

☞ Cmd Driving Pull-Down Level

Options are: Auto (default), +8~-7.

☞ Ctrl Driving Pull-Down Level

Options are: Auto (default), +8~-7.

☞ Clk Driving Pull-Down Level

Options are: Auto (default), +8~-7.

***** Mother Board Voltage Control *****

>>> CPU

☞ CPU Vcore

The default is Auto.

☞ CPU Termination

The default is Auto.

>>> DRAM

☞ DRAM Voltage

The default is Auto.

2-4 Standard CMOS Features

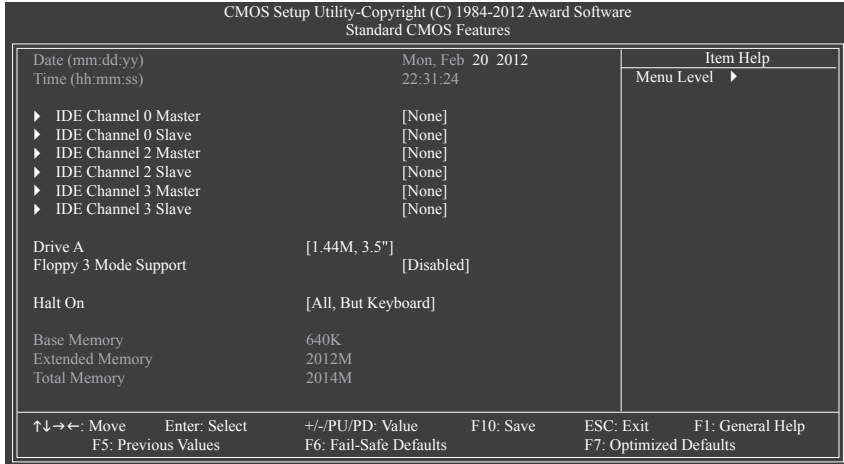

☞ Date (mm:dd:yy)

Sets the system date.

☞ Time (hh:mm:ss)

Sets the system time.

☞ IDE Channel 0, 2, 3 Master/Slave

▶▶ IDE HDD Auto-Detection, IDE Auto-Detection

Press <Enter> to autodetect the parameters of the IDE/SATA device on this channel.

▶▶ IDE Channel 0 Master/Slave, Extended IDE Drive

Configure your IDE/SATA devices by using one of the three methods below:

- Auto Lets the BIOS automatically detect IDE/SATA devices during the POST. (Default)
- None If no IDE/SATA devices are used, set this item to **None** so the system will skip the detection of the device during the POST for faster system startup.
- Manual Allows you to manually enter the specifications of the hard drive when the hard drive access mode is set to **CHS**. (For **IDE Channel 0 Master/Slave** only.)

▶▶ Access Mode Sets the hard drive access mode. (Default: Auto)

The following fields display your hard drive specifications. If you wish to enter the parameters manually, refer to the information on the hard drive.

- ▶▶ Capacity Approximate capacity of the currently installed hard drive.
- ▶▶ Cylinder Number of cylinders.
- ▶▶ Head Number of heads.
- ▶▶ Precomp Write precompensation cylinder.
- ▶▶ Landing Zone Landing zone.
- ▶▶ Sector Number of sectors.

☞ Drive A

Allows you to select the type of floppy disk drive installed in your system. If you do not install a floppy disk drive, set this item to **None**. Options are: None, 360K/5.25", 1.2M/5.25", 720K/3.5", 1.44M/3.5", 2.88M/3.5".

☞ Floppy 3 Mode Support

Allows you to specify whether the installed floppy disk drive is 3-mode floppy disk drive, a Japanese standard floppy disk drive. Options are: Disabled (default), Drive A.

☞ Halt On

Allows you to determine whether the system will stop for an error during the POST.

Options are: "All Errors," "No Errors," "All, But Keyboard" (default), "All, But Diskette," "All, But Disk/Key."

☞ Memory

These fields are read-only and are determined by the BIOS POST.

2-5 Advanced BIOS Features

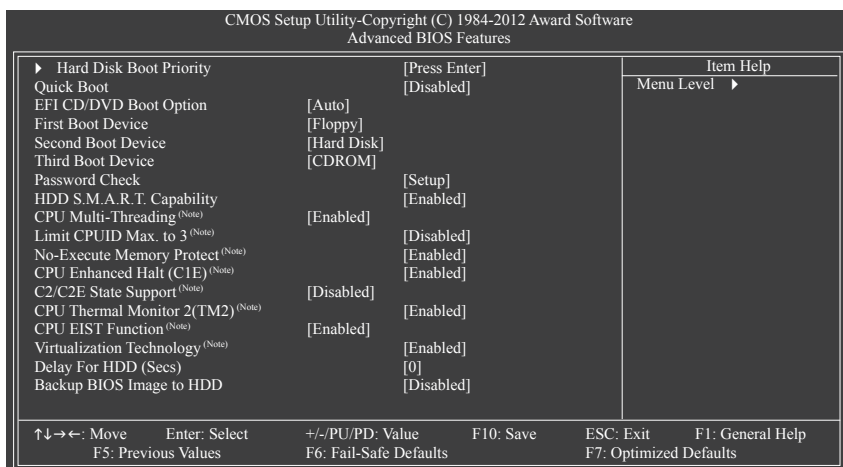

☞ Hard Disk Boot Priority

Specifies the sequence of loading the operating system from the installed hard drives.

☞ Quick Boot

Enables or disables the quick boot function to speed up the system boot-up process to shorten the waiting time for entering the operating system and to deliver greater efficiency for daily use. (Default: Disabled)

☞ EFI CD/DVD Boot Option

Set this item to **EFI** if you want to install the operating system to a hard drive larger than 2.2 TB. Make sure the operating system to be installed supports booting from a GPT partition, such as Windows 7 64-bit and Windows Server 2003 64-bit. **Auto** lets the BIOS automatically configure this setting depending on the hard drive you install. (Default: Auto)

☞ First/Second/Third Boot Device

Specifies the boot order from the available devices.

(Note) This item is present only if you install a CPU that supports this feature. For more information about Intel CPUs' unique features, please visit Intel's website.

⌵ **Password Check**

Specifies whether a password is required every time the system boots, or only when you enter BIOS Setup. After configuring this item, set the password(s) under the **Set Supervisor/User Password** item in the BIOS Main Menu.

- ▶▶ Setup A password is only required for entering the BIOS Setup program. (Default)
- ▶▶ System A password is required for booting the system and for entering the BIOS Setup program.

⌵ **HDD S.M.A.R.T. Capability**

Enables or disables the S.M.A.R.T. (Self Monitoring and Reporting Technology) capability of your hard drive. This feature allows your system to report read/write errors of the hard drive and to issue warnings when a third party hardware monitor utility is installed. (Default: Enabled)

⌵ **CPU Multi-Threading** ^(Note)

Allows you to determine whether to enable all CPU cores and multi-threading function when using an Intel CPU that supports multi-core technology. This feature only works for operating systems that support multi-processor mode.

- ▶▶ Enabled Enables all CPU cores and multi-threading capability. (Default)
- ▶▶ Disabled Enables only one CPU core.

⌵ **Limit CPUID Max. to 3** ^(Note)

Allows you to determine whether to limit CPUID maximum value. Set this item to **Disabled** for Windows XP operating system; set this item to **Enabled** for legacy operating system such as Windows NT4.0. (Default: Disabled)

⌵ **No-Execute Memory Protect** ^(Note)

Enables or disables Intel Execute Disable Bit function. This function may enhance protection for the computer, reducing exposure to viruses and malicious buffer overflow attacks when working with its supporting software and system. (Default: Enabled)

⌵ **CPU Enhanced Halt (C1E)** ^(Note)

Enables or disables Intel CPU Enhanced Halt (C1E) function, a CPU power-saving function in system halt state. When enabled, the CPU core frequency and voltage will be reduced during system halt state to decrease power consumption. (Default: Enabled)

⌵ **C2/C2E State Support** ^(Note)

Allows you to determine whether to let the CPU enter C2/C2E mode in system halt state. When enabled, the CPU core frequency and voltage will be reduced during system halt state to decrease power consumption. (Default: Disabled)

⌵ **CPU Thermal Monitor 2 (TM2)** ^(Note)

Enables or disables Intel CPU Thermal Monitor (TM2) function, a CPU overheating protection function. When enabled, the CPU core frequency and voltage will be reduced when the CPU is overheated. (Default: Enabled)

⌵ **CPU EIST Function** ^(Note)

Enables or disables Enhanced Intel SpeedStep Technology (EIST). Depending on CPU loading, Intel EIST technology can dynamically and effectively lower the CPU voltage and core frequency to decrease average power consumption and heat production. (Default: Enabled)

(Note) This item is present only if you install a CPU that supports this feature. For more information about Intel CPUs' unique features, please visit Intel's website.

Virtualization Technology ^(Note)

Enables or disables Intel Virtualization Technology. Virtualization enhanced by Intel Virtualization Technology will allow a platform to run multiple operating systems and applications in independent partitions. With virtualization, one computer system can function as multiple virtual systems. (Default: Enabled)

Delay For HDD (Secs)

Allows you to set a delay time for the BIOS to initialize the hard drive as the system boots up. The adjustable range is from 0 to 15 seconds. (Default: 0)

Backup BIOS Image to HDD

Allows the system to copy the BIOS image file to the hard drive. If the system BIOS is corrupted, it will be recovered from this image file. (Default: Disabled)

2-6 Advanced Chipset Features

CMOS Setup Utility-Copyright (C) 1984-2012 Award Software	
Advanced Chipset Features	
** VGA Setting **	Item Help
Onboard VGA [Enable If No Ext PEG]	Menu Level ▶
Init Display First [PCI]	
PAVP Mode [PAVP Lite Mode]	
PAVP Lite Mode [32MB]	
x Paranoid PAVP Mode (32+96)128MB	
↑↓→←: Move Enter: Select +/-/PU/PD: Value F10: Save ESC: Exit F1: General Help	F5: Previous Values F6: Fail-Safe Defaults F7: Optimized Defaults

Onboard VGA

Enables or disables the onboard graphics function.

▶▶ Enable If No Ext PEG

Activates the onboard graphics only if no PCI Express graphics card is installed. (Default)

▶▶ Always Enable

Always activates the onboard graphics, whether or not a PCI Express card is installed. If you wish to set up a dual view configuration, set this item to **Always Enable**.

Init Display First

Specifies the first initiation of the monitor display from the installed PCI graphics card, PCI Express graphics card or the onboard graphics.

▶▶ PCI Sets the PCI graphics card as the first display. (Default)

▶▶ Onboard Sets the onboard graphics as the first display.

▶▶ PEG Sets the PCI Express graphics card as the first display.

PAVP Mode

Enables or disables PAVP mode. Enable this function if you wish to playback HDCP contents. PAVP mode can support increased content protection and robustness requirements for premium content playback (e.g. Blu-ray disc).

▶▶ Disabled Disables this function.

▶▶ PAVP Lite Mode Specifies the buffer memory size for the encryption of compressed video. (Default)

▶▶ Paranoid PAVP Reserves 96 MB of system memory during boot. This memory is not seen by the operating system and not available to any user application. Aero (DWM) in Windows Vista will always be turned off in this mode.

(Note) This item is present only if you install a CPU that supports this feature. For more information about Intel CPUs' unique features, please visit Intel's website.

☞ PAVP Lite Mode

This item is configurable only if the **PAVP Mode** option is set to **PAVP Lite Mode**.

Options are: 32MB (default), 48MB, 64MB, 128MB and 256MB.

☞ Paranoid PAVP Mode

This item is configurable only if the **PAVP Mode** option is set to **Paranoid PAVP**.

Options are: (32+96)128MB (default), (48+96) Round to 160MB, (64+96)160MB, (128+96)224MB and (256+96)352MB.

The table below shows the supported features of the PAVP Lite and Paranoid modes.

Feature	PAVP Lite	PAVP Paranoid
Compressed video buffer is encrypted	Yes	Yes
Hardware 128-bit AES decryption	Yes	Yes
Protected memory (96 MB reserved during boot)	No	Yes

2-7 Integrated Peripherals

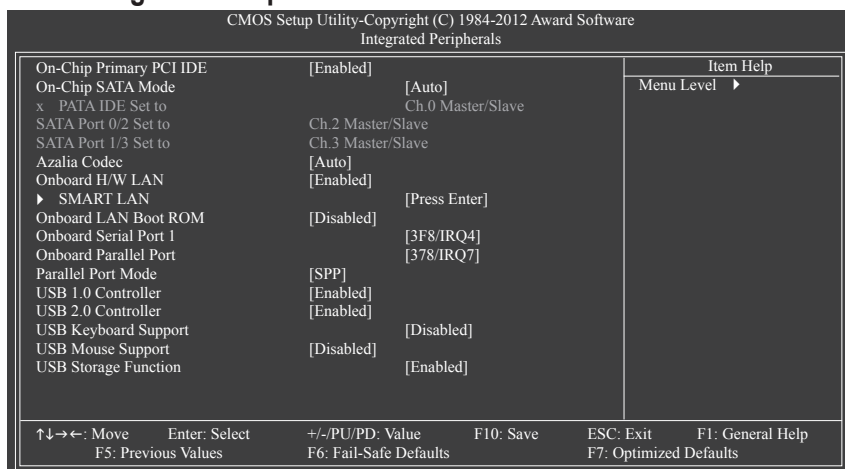

☞ On-Chip Primary PCI IDE

Enables or disables the first integrated IDE controller. (Default: Enabled)

☞ On-Chip SATA Mode

Configures the integrated SATA controller.

- ▶▶ Disabled Disables the integrated SATA controller.
- ▶▶ Auto Lets the BIOS set SATA devices to **Combined** or **Enhanced mode**.
If your onboard SATA controller is automatically configured to **Combined** mode, you can manually re-configure it to **Enhanced** mode as needed. (Default)
- ▶▶ Combined Sets all SATA devices to operate in PATA mode. **Combined** allows a maximum of 4 ATA devices to be used simultaneously: two PATA devices plus two SATA devices.
- ▶▶ Enhanced Sets all SATA devices to operate in SATA mode.
- ▶▶ Non-Combined Sets all SATA devices to operate in PATA mode and disables the integrated IDE controller.

☞ **PATA IDE Set to**

This item is configurable only if the **On-Chip SATA Mode** is set to **Combined**.

- ▶▶ Ch.0 Master/Slave Sets the IDE channels to Ch. 0 Master/Slave. (Default)
- ▶▶ Ch.1 Master/Slave Sets the IDE channels to Ch. 1 Master/Slave.

☞ **SATA Port 0/2 Set to**

This value is dependent on the **On-Chip SATA Mode** and **PATA IDE Set to** settings.

When **PATA IDE Set to** is configured to **Ch. 1 Master/Slave**, this option will be automatically set to **Ch. 0 Master/Slave**.

☞ **SATA Port 1/3 Set to**

This value is dependent on the **On-Chip SATA Mode** and **PATA IDE Set to** settings.

When **PATA IDE Set to** is configured to **Ch. 0 Master/Slave**, this option will be automatically set to **Ch. 1 Master/Slave**.

☞ **Azalia Codec**

Enables or disables the onboard audio function. (Default: Auto)

If you wish to install a 3rd party add-in audio card instead of using the onboard audio, set this item to **Disabled**.

☞ **Onboard H/W LAN**

Enables or disables the onboard LAN function. (Default: Enabled)

If you wish to install a 3rd party add-in network card instead of using the onboard LAN, set this item to **Disabled**.

☞ **SMART LAN (LAN Cable Diagnostic Function)**

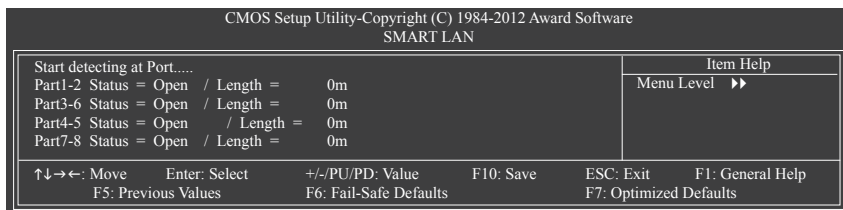

This motherboard incorporates cable diagnostic feature designed to detect the status of the attached LAN cable. This feature will detect cabling issue and report the approximate distance to the fault or short.

☞ **Onboard LAN Boot ROM**

Allows you to decide whether to activate the boot ROM integrated with the onboard LAN chip. (Default: Disabled)

☞ **Onboard Serial Port 1**

Enables or disables the onboard serial port and specifies its base I/O address and corresponding interrupt. Options are: Auto, 3F8/IRQ4 (default), 2F8/IRQ3, 3E8/IRQ4, 2E8/IRQ3, Disabled.

☞ **Onboard Parallel Port**

Enables or disables the onboard parallel port (LPT) and specifies its base I/O address and corresponding interrupt. Options are: 378/IRQ7 (default), 278/IRQ5, 3BC/IRQ7, Disabled.

☞ **Soft-Off by PWR-BTTN**

Configures the way to turn off the computer in MS-DOS mode using the power button.

- ▶▶ **Instant-Off** Press the power button and then the system will be turned off instantly. (Default)
- ▶▶ **Delay 4 Sec.** Press and hold the power button for 4 seconds to turn off the system. If the power button is pressed for less than 4 seconds, the system will enter suspend mode.

☞ **PME Event Wake Up**

Allows the system to be awakened from an ACPI sleep state by a wake-up signal from a PCI or PCIe device. Note: To use this function, you need an ATX power supply providing at least 1A on the +5VSB lead. (Default: Enabled)

☞ **Power On by Ring**

Allows the system to be awakened from an ACPI sleep state by a wake-up signal from a modem that supports wake-up function. (Default: Enabled)

☞ **Resume by Alarm**

Determines whether to power on the system at a desired time. (Default: Disabled)

If enabled, set the date and time as following:

- ▶▶ **Date (of Month) Alarm:** Turn on the system at a specific time on each day or on a specific day in a month.
- ▶▶ **Time (hh: mm: ss) Alarm:** Set the time at which the system will be powered on automatically.

Note: When using this function, avoid inadequate shutdown from the operating system or removal of the AC power, or the settings may not be effective.

☞ **HPET Support** ^(Note)

Enables or disables High Precision Event Timer (HPET) for Windows 7/Vista operating system. (Default: Enabled)

☞ **HPET Mode** ^(Note)

Allows you to select the HPET mode for your Windows 7/Vista operating system. This item is configurable only if the **HPET Support** is set to **Enabled**. (Default: 32-bit mode)

☞ **Power On By Mouse**

Allows the system to be turned on by a PS/2 mouse wake-up event. (Default: Disabled)

Note: To use this function, you need an ATX power supply providing at least 1A on the +5VSB lead.

- ▶▶ **Double Click** Double click on left button on the PS/2 mouse to turn on the system.

☞ **Power On By Keyboard**

Allows the system to be turned on by a PS/2 keyboard wake-up event. (Default: Disabled)

Note: you need an ATX power supply providing at least 1A on the +5VSB lead.

- ▶▶ **Password** Set a password with 1~5 characters to turn on the system.
- ▶▶ **Keyboard 98** Press POWER button on the Windows 98 keyboard to turn on the system.

☞ **KB Power ON Password**

Set the password when **Power On by Keyboard** is set to **Password**. Press <Enter> on this item and set a password with up to 5 characters and then press <Enter> to accept. To turn on the system, enter the password and press <Enter>.

Note: To cancel the password, press <Enter> on this item. When prompted for the password, press <Enter> again without entering the password to clear the password settings.

(Note) Supported on Windows 7/Vista operating system only.

AC Back Function

Determines the state of the system after the return of power from an AC power loss.

- ▶▶ Soft-Off The system stays off upon the return of the AC power. (Default)
- ▶▶ Full-On The system is turned on upon the return of the AC power.
- ▶▶ Memory The system returns to its last known awake state upon the return of the AC power.

ErP Support

Determines whether to let the system consume less than 1W power in S5 (shutdown) state. (Default: Disabled)

Note: When this item is set to **Enabled**, the following four functions will become unavailable: PME event wake up, power on by mouse, power on by keyboard, and wake on LAN.

2-9 PnP/PCI Configurations

CMOS Setup Utility-Copyright (C) 1984-2012 Award Software			
PnP/PCI Configurations			
PCI1 IRQ Assignment	[Auto]	Item Help	
PCI2 IRQ Assignment	[Auto]	Menu Level ▶	
↑↓→←: Move	Enter: Select	+/-/PU/PD: Value	F10: Save
F5: Previous Values		F6: Fail-Safe Defaults	ESC: Exit
			F1: General Help
			F7: Optimized Defaults

PCI1/2 IRQ Assignment

- ▶▶ Auto BIOS auto-assigns IRQ to the first/second PCI slot. (Default)
- ▶▶ 3,4,5,7,9,10,11,12,14,15 Assigns IRQ 3,4,5,7,9,10,11,12,14,15 to the first/second PCI slot.

2-10 PC Health Status

CMOS Setup Utility-Copyright (C) 1984-2012 Award Software			
PC Health Status			
Reset Case Open Status	[Disabled]	Item Help	
Case Opened	No	Menu Level ▶	
Vcore	1.300V		
DDR		1.584V	
+3.3V	3.280V		
+12V		12.112V	
Current CPU Temperature	32°C		
Current CPU FAN Speed	2872 RPM		
Current SYSTEM FAN Speed	0	RPM	
CPU Warning Temperature	[Disabled]		
CPU FAN Fail Warning		[Disabled]	
SYSTEM FAN Fail Warning		[Disabled]	
CPU Smart FAN Control	[Enabled]		
↑↓→←: Move	Enter: Select	+/-/PU/PD: Value	F10: Save
F5: Previous Values		F6: Fail-Safe Defaults	ESC: Exit
			F1: General Help
			F7: Optimized Defaults

Reset Case Open Status

Keeps or clears the record of previous chassis intrusion status. **Enabled** clears the record of previous chassis intrusion status and the **Case Opened** field will show "No" at next boot. (Default: Disabled)

☞ **Case Opened**

Displays the detection status of the chassis intrusion detection device attached to the motherboard CI header. If the system chassis cover is removed, this field will show "Yes", otherwise it will show "No". To clear the chassis intrusion status record, set **Reset Case Open Status** to **Enabled**, save the settings to the CMOS, and then restart your system.

☞ **Current Voltage(V) Vcore/DDR/+3.3V/+12V**

Displays the current system voltages.

☞ **Current CPU Temperature**

Displays current CPU temperature.

☞ **Current CPU/SYSTEM FAN Speed (RPM)**

Displays current CPU/system fan speed.

☞ **CPU Warning Temperature**

Sets the warning threshold for CPU temperature. When CPU temperature exceeds the threshold, BIOS will emit warning sound. Options are: Disabled (default), 60°C/140°F, 70°C/158°F, 80°C/176°F, 90°C/194°F.

☞ **CPU/SYSTEM FAN Fail Warning**

Allows the system to emit warning sound if the CPU/system fan is not connected or fails. Check the fan condition or fan connection when this occurs. (Default: Disabled)

☞ **CPU Smart FAN Control**

Enables or disables the CPU fan speed control function. **Enabled** allows the CPU fan to run at different speed according to the CPU temperature. You can adjust the fan speed with EasyTune based on system requirements. If disabled, CPU fan runs at full speed. (Default: Enabled)

2-11 Load Fail-Safe Defaults

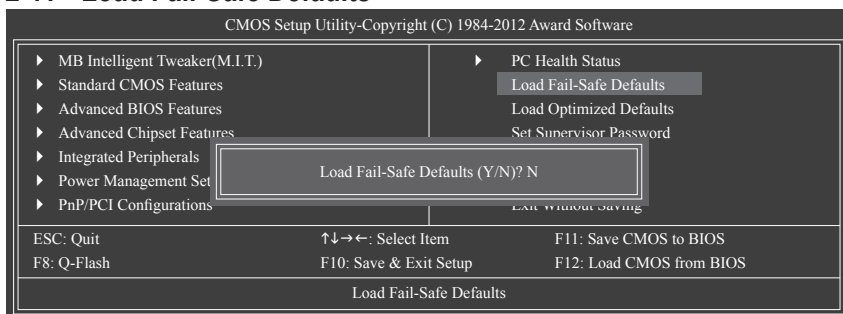

Press <Enter> on this item and then press the <Y> key to load the safest BIOS default settings.

In case system instability occurs, you may try to load Fail-Safe defaults, which are the safest and most stable BIOS settings for the motherboard.

2-12 Load Optimized Defaults

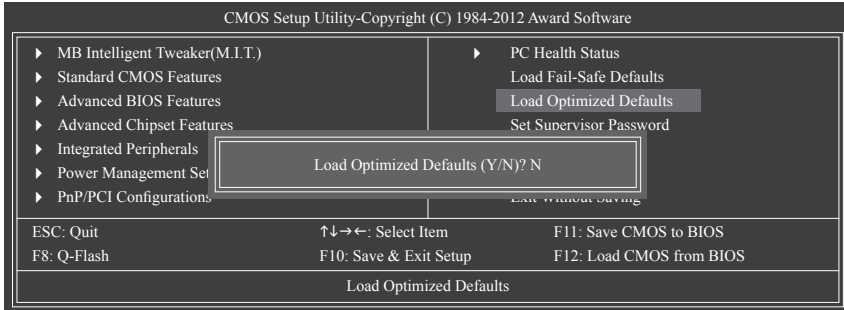

Press <Enter> on this item and then press the <Y> key to load the optimal BIOS default settings.

The BIOS default settings help the system to operate in optimum state. Always load the Optimized defaults after updating the BIOS or after clearing the CMOS values.

2-13 Set Supervisor/User Password

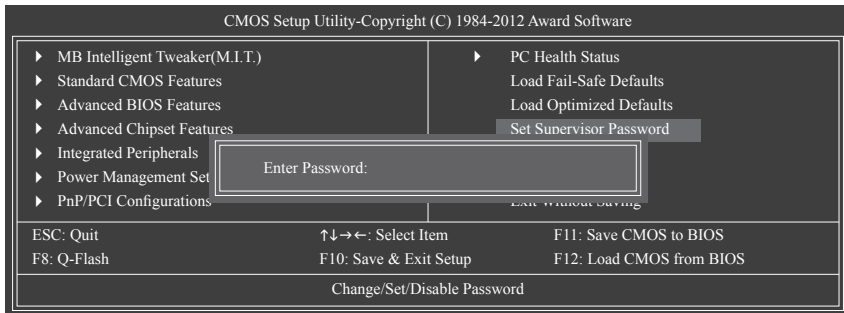

Press <Enter> on this item and type the password with up to 8 characters and then press <Enter>. You will be requested to confirm the password. Type the password again and press <Enter>.

The BIOS Setup program allows you to specify two separate passwords:

☞ Supervisor Password

When a system password is set and the **Password Check** item in **Advanced BIOS Features** is set to **Setup**, you must enter the supervisor password for entering BIOS Setup and making BIOS changes.

When the **Password Check** item is set to **System**, you must enter the supervisor password (or user password) at system startup and when entering BIOS Setup.

☞ User Password

When the **Password Check** item is set to **System**, you must enter the supervisor password (or user password) at system startup to continue system boot. In BIOS Setup, you must enter the supervisor password if you wish to make changes to BIOS settings. The user password only allows you to view the BIOS settings but not to make changes.

To clear the password, press <Enter> on the password item and when requested for the password, press <Enter> again. The message "PASSWORD DISABLED" will appear, indicating the password has been cancelled.

2-14 Save & Exit Setup

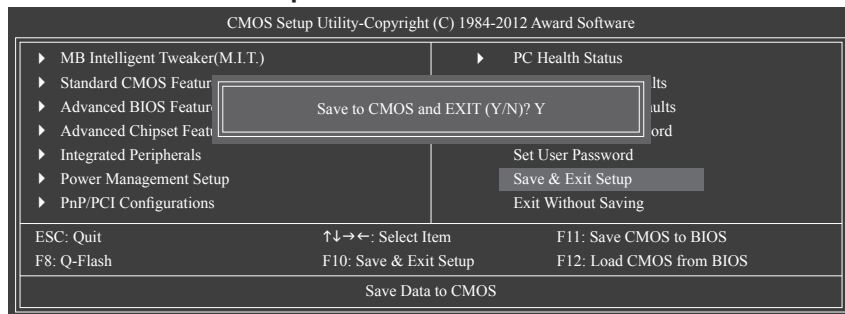

Press <Enter> on this item and press the <Y> key. This saves the changes to the CMOS and exits the BIOS Setup program. Press <N> or <Esc> to return to the BIOS Setup Main Menu.

2-15 Exit Without Saving

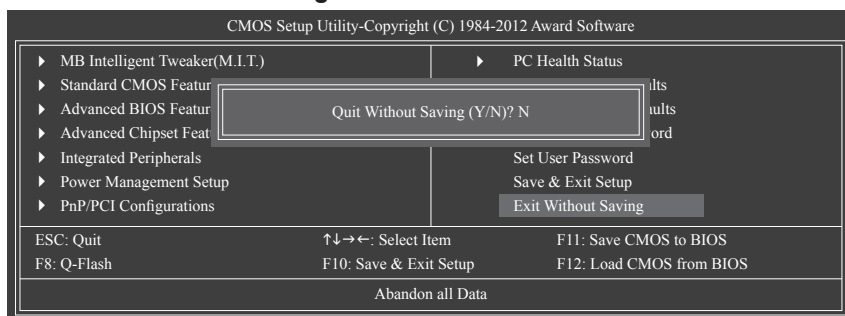

Press <Enter> on this item and press the <Y> key. This exits the BIOS Setup without saving the changes made in BIOS Setup to the CMOS. Press <N> or <Esc> to return to the BIOS Setup Main Menu.

Chapter 3 Drivers Installation



- Before installing the drivers, first install the operating system.
- After installing the operating system, insert the motherboard driver disk into your optical drive. The driver Autorun screen is automatically displayed which looks like that shown in the screen shot below. (If the driver Autorun screen does not appear automatically, go to My Computer, double-click the optical drive and execute the **Run.exe** program.)

3-1 Installing Chipset Drivers

After inserting the driver disk, "Xpress Install" will automatically scan your system and then list all the drivers that are recommended to install. You can click the **Install All** button and "Xpress Install" will install all the recommended drivers. Or click **Install Single Items** to manually select the drivers you wish to install.

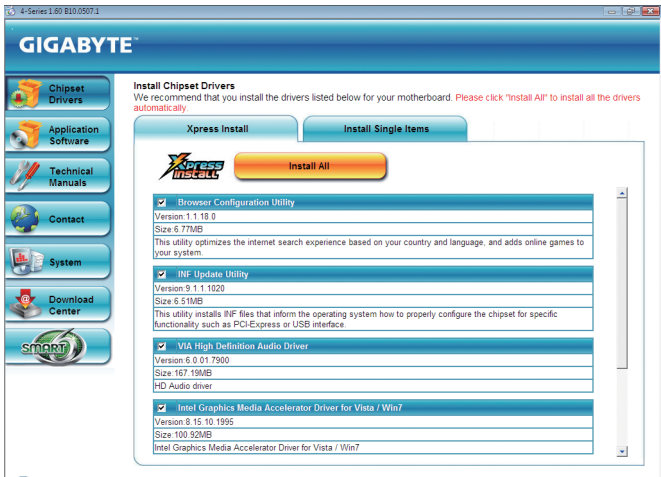

Regulatory Statements

Regulatory Notices

This document must not be copied without our written permission, and the contents there of must not be imparted to a third party nor be used for any unauthorized purpose.

Contravention will be prosecuted. We believe that the information contained herein was accurate in all respects at the time of printing. GIGABYTE cannot, however, assume any responsibility for errors or omissions in this text. Also note that the information in this document is subject to change without notice and should not be construed as a commitment by GIGABYTE.

Our Commitment to Preserving the Environment

In addition to high-efficiency performance, all GIGABYTE motherboards fulfill European Union regulations for RoHS (Restriction of Certain Hazardous Substances in Electrical and Electronic Equipment) and WEEE (Waste Electrical and Electronic Equipment) environmental directives, as well as most major worldwide safety requirements. To prevent releases of harmful substances into the environment and to maximize the use of our natural resources, GIGABYTE provides the following information on how you can responsibly recycle or reuse most of the materials in your "end of life" product.

Restriction of Hazardous Substances (RoHS) Directive Statement

GIGABYTE products have not intended to add and safe from hazardous substances (Cd, Pb, Hg, Cr+6, PBDE and PBB). The parts and components have been carefully selected to meet RoHS requirement. Moreover, we at GIGABYTE are continuing our efforts to develop products that do not use internationally banned toxic chemicals.

Waste Electrical & Electronic Equipment (WEEE) Directive Statement

GIGABYTE will fulfill the national laws as interpreted from the 2002/96/EC WEEE (Waste Electrical and Electronic Equipment) directive. The WEEE Directive specifies the treatment, collection, recycling and disposal of electric and electronic devices and their components. Under the Directive, used equipment must be marked, collected separately, and disposed of properly.

WEEE Symbol Statement



The symbol shown below is on the product or on its packaging, which indicates that this product must not be disposed of with other waste. Instead, the device should be taken to the waste collection centers for activation of the treatment, collection, recycling and disposal procedure. The separate collection and recycling of your waste equipment at the time of disposal will help to conserve natural resources and ensure that it is recycled in a manner that protects human health and the environment. For more information about where you can drop off your waste equipment for recycling, please contact your local government office, your household waste disposal service or where you purchased the product for details of environmentally safe recycling.

- When your electrical or electronic equipment is no longer useful to you, "take it back" to your local or regional waste collection administration for recycling.
- If you need further assistance in recycling, reusing in your "end of life" product, you may contact us at the Customer Care number listed in your product's user's manual and we will be glad to help you with your effort.

Finally, we suggest that you practice other environmentally friendly actions by understanding and using the energy-saving features of this product (where applicable), recycling the inner and outer packaging (including shipping containers) this product was delivered in, and by disposing of or recycling used batteries properly. With your help, we can reduce the amount of natural resources needed to produce electrical and electronic equipment, minimize the use of landfills for the disposal of "end of life" products, and generally improve our quality of life by ensuring that potentially hazardous substances are not released into the environment and are disposed of properly.

FCC Notice (U.S.A. Only)

This equipment has been tested and found to comply with the limits for a Class B digital device, pursuant to Part 15 of the FCC Rules. These limits are designed to provide reasonable protection against harmful interference in a residential installation. This equipment generates, uses, and can radiate radio frequency energy and, if not installed and used in accordance with the instructions, may cause harmful interference to radio communications. However, there is no guarantee that interference will not occur in a particular installation. If this equipment does cause harmful interference to radio or television reception, which can be determined by turning the equipment off and on, the user is encouraged to try to correct the interference by one or more of the following measures:

- ♦ Reorient or relocate the receiving antenna.
- ♦ Increase the separation between the equipment and receiver.
- ♦ Connect the equipment into an outlet on a circuit different from that to which the receiver is connected.
- ♦ Consult a dealer or experienced TV/radio technician for help.

Canada, Industry Canada (IC) Notices / Canada, avis d'Industry Canada (IC)

- ♦ This Class B digital apparatus complies with Canadian ICES-003 and RSS-210.
- ♦ Operation is subject to the following two conditions: (1) this device may not cause interference, and (2) this device must accept any interference, including interference that may cause undesired operation of the device.
- ♦ Cet appareil numérique de classe B est conforme aux normes canadiennes ICES-003 et RSS-210.
- ♦ Son fonctionnement est soumis aux deux conditions suivantes : (1) cet appareil ne doit pas causer d'interférence et (2) cet appareil doit accepter toute interférence, notamment les interférences qui peuvent affecter son fonctionnement.



Contact Us

GIGA-BYTE TECHNOLOGY CO., LTD.

Address: No.6, Baoqiang Road, Xindian Dist., New Taipei City 231, Taiwan

TEL: +886-2-8912-4000, FAX: +886-2-8912-4005

Tech. and Non-Tech. Support (Sales/Marketing) : <http://esupport.gigabyte.com>

WEB address (English): <http://www.gigabyte.com>

WEB address (Chinese): <http://www.gigabyte.tw>

- **GIGABYTE eSupport**

To submit a technical or non-technical (Sales/Marketing) question, please link to:
<http://esupport.gigabyte.com>

GIGABYTE **eSupport**

News

Downloads FAQ Warranty

Sign in with

GIGABYTE Passport

E-mail:

Password: [Forget password?](#)

Login [Not a member yet?](#)

All intellectual property rights, including without limitation to copyright and trademark of this work and its derivative works, are the property of, or are licensed to, GIGABYTE TECHNOLOGY CO., LTD. Any unauthorized use is strictly prohibited.