

MZBSWAI

Intel® Celeron® Processor N3150

User's Manual

Rev. 1001

Copyright

© 2015 GIGA-BYTE TECHNOLOGY CO., LTD. All rights reserved.

The trademarks mentioned in this manual are legally registered to their respective owners.

Disclaimer

Information in this manual is protected by copyright laws and is the property of GIGABYTE.

Changes to the specifications and features in this manual may be made by GIGABYTE without prior notice. No part of this manual may be reproduced, copied, translated, transmitted, or published in any form or by any means without GIGABYTE's prior written permission.

Documentation Classifications

In order to assist in the use of this product, GIGABYTE provides the following types of documentations:

- For detailed product information, carefully read the User's Manual.

For product-related information, check on our website at:

<http://www.gigabyte.com>

Table of Contents

Box Contents	4
MZBSWAI Motherboard Layout.....	5
Block Diagram	7
Chapter 1 Hardware Installation	8
1-1 Installation Precautions	8
1-2 Product Specifications.....	9
1-3 Installing the Memory	11
1-3-1 Installing a Memory	11
1-4 Back Panel Connectors.....	12
1-5 Internal Connectors.....	13
Chapter 2 BIOS Setup	24
2-1 The Main Menu	26
2-2 Advanced Menu	28
2-2-1 Super IO Configuration.....	29
2-2-1-1 Serial Port Configuration	30
2-2-1-2 Parallel Port Configuration.....	31
2-2-2 Hardware Monitor	32
2-2-3 S5 RTC Wake Settings.....	33
2-2-4 CPU Configuration.....	34
2-2-4-1 CPU Information	35
2-2-5 SATA Configuration.....	36
2-2-6 OS Selection.....	37
2-3 Chipset Menu	38
2-4 Security Menu	40
2-4-1 Secure Boot menu.....	41
2-4-1-1 Key Management	42
2-5 Boot Menu.....	43
2-6 Save & Exit Menu.....	44

Box Contents

- Motherboard
- One SATA power cables
- Two I/O Shield (Standard 44.45mm/Low-Profile 25.54mm)
- One Screw

- The box contents above are for reference only and the actual items shall depend on the product package you obtain. The box contents are subject to change without notice.
- The motherboard image is for reference only.

MZBSWAI Motherboard Layout

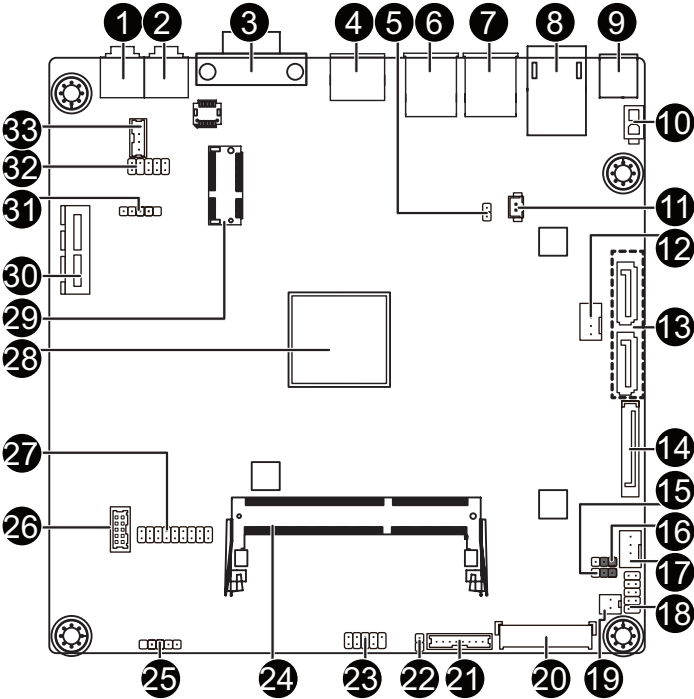

Item	Code	Description
1	MIC_IN	Audio Mic In port
2	LINE_OUT	Audio Line Out port
3	VGA	VGA port
4	HDMI	HDMI port
5	CLR_CMOS	Clear CMOS jumper
6	USB3_2	USB 3.0 ports
7	USB3_1	USB 3.0 ports
8	LAN	RJ45 LAN port
9	DC_IN	DC In power connector
10	ATX_19V	2 pin power connector
11	BAT_CON	Battery cable connector
12	CPU_FAN	CPU fan connector
13	SATAIII_0/SATAIII_1	SATA 6Gb/s cable connectors
14	SATA_PWR	Hard disk power connector
15	LCD_VCC	LVDS Drive voltage jumper
16	FPD_PWR	LVDS power select jumper (12V/19V)
17	SYS_FAN	System fan connector
18	SYS_PANEL	Front panel header
19	MS_SW	Monitor power switch header
20	LVDS	LVDS connector
21	FPD	Flat Panel Display connector
22	BL_SW	Back light brightness switch
23	FUSB2_1	USB 2.0 header
24	SO_DIMM	DDR3 SO-DIMM slot
25	FUSB2_2	USB 2.0 header
26	COM1	Serial port cable connector
27	LPT	Parallel port header
28	CPU	Intel Celeron® Processor N3150, SoC
29	M2E	PCI Express M.2 connector
30	PCIE1X	PCI Express x 1 slot
31	DMIC_CON	Digital Mic connector
32	FP_AUDIO	Front audio header
33	SPKR	Speaker cable connector

Block Diagram

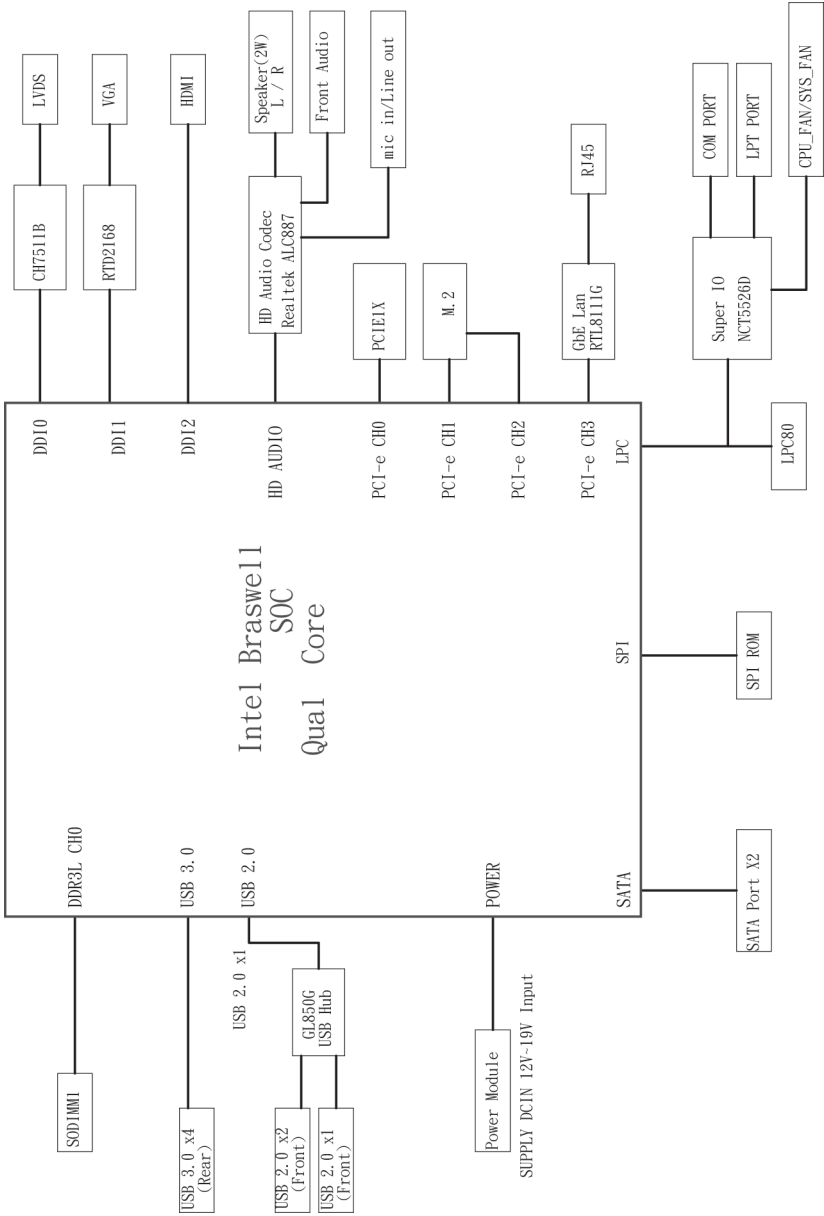











Chapter 1 Hardware Installation



1-1 Installation Precautions

The motherboard contains numerous delicate electronic circuits and components which can become damaged as a result of electrostatic discharge (ESD). Prior to installation, carefully read the user's manual and follow these procedures:

- Prior to installation, do not remove or break motherboard S/N (Serial Number) sticker or warranty sticker provided by your dealer. These stickers are required for warranty validation.
- Always remove the AC power by unplugging the power cord from the power outlet before installing or removing the motherboard or other hardware components.
- When connecting hardware components to the internal connectors on the motherboard, make sure they are connected tightly and securely.
- When handling the motherboard, avoid touching any metal leads or connectors.
- It is best to wear an electrostatic discharge (ESD) wrist strap when handling electronic components such as a motherboard, CPU or memory. If you do not have an ESD wrist strap, keep your hands dry and first touch a metal object to eliminate static electricity.
- Prior to installing the motherboard, please have it on top of an antistatic pad or within an electrostatic shielding container.
- Before unplugging the power supply cable from the motherboard, make sure the power supply has been turned off.
- Before turning on the power, make sure the power supply voltage has been set according to the local voltage standard.
- Before using the product, please verify that all cables and power connectors of your hardware components are connected.
- To prevent damage to the motherboard, do not allow screws to come in contact with the motherboard circuit or its components.
- Make sure there are no leftover screws or metal components placed on the motherboard or within the computer casing.
- Do not place the computer system on an uneven surface.
- Do not place the computer system in a high-temperature environment.
- Turning on the computer power during the installation process can lead to damage to system components as well as physical harm to the user.
- If you are uncertain about any installation steps or have a problem related to the use of the product, please consult a certified computer technician.

1-2 Product Specifications

 CPU	<ul style="list-style-type: none"> ◆ Intel® Celeron® Processor N3150, SoC, Quad Core ◆ L1/L2 cache varies with CPU
 Memory	<ul style="list-style-type: none"> ◆ 1 x SO-DIMM slots support 1.35V DDR3L 1600MHz ◆ Support up 8GB
 Audio	<ul style="list-style-type: none"> ◆ Realtek® ALC887 HD Audio Codec ◆ 2 channel
 LAN	<ul style="list-style-type: none"> ◆ 1 x Realtek RTL8111HS-CG GbE controller supports 10/100/1000 Mbps
 Expansion Slots	<ul style="list-style-type: none"> ◆ 1 x PCI Express x1 slot ◆ 1 x M.2 slot (PCI Express Interface): <ul style="list-style-type: none"> * Socket 3 * M key
 Onboard Graphics	<ul style="list-style-type: none"> ◆ Build in Intel® processor ◆ 1 D-sub VGA Port, 1 HDMI Port, 1 LVDS 18bit/24bit (1920x1080)
 Storage Interface	<ul style="list-style-type: none"> ◆ 2 x SATA 6Gb/s connector
 USB	<ul style="list-style-type: none"> ◆ 4 x USB 3.0 port (back panel) ◆ 3 x USB 2.0 headers (3 additional ports via the USB brackets connected to the internal USB headers)
 Internal Connectors	<ul style="list-style-type: none"> ◆ 1 x 2-pin power connector ◆ 2 x SATA 6Gb/s connector ◆ 1 x SATA HDD power connector ◆ 1 x CPU fan header ◆ 1 x System fan header ◆ 1 x System panel header ◆ 1 x Back Light Brightness header ◆ 1 x Audio header ◆ 3 x USB 2.0 headers ◆ 1 x LVDS connector ◆ 1 x FPD connector ◆ 1 x DMIC header ◆ 1 x Serial port cable connector ◆ 1 x Parallel port cable header ◆ 1 x Speaker cable connector
 Back Panel Connectors	<ul style="list-style-type: none"> ◆ 1 x DC-IN ◆ 1 x RJ-45 port ◆ 1 x HDMI port ◆ 4 x USB 3.0 port ◆ 1 x VGA port ◆ 1 x Audio MIC In ◆ 1 x Audio Line Out
 I/O Controller	<ul style="list-style-type: none"> ◆ Nuvoton NCT5526D chip

	Hardware Monitor	<ul style="list-style-type: none"> ◆ CPU temperature detection ◆ CPU/System fan speed control <ul style="list-style-type: none"> * Whether the CPU/system fan speed control function is supported will depend on the CPU/system cooler you install.
	BIOS	<ul style="list-style-type: none"> ◆ AMI BIOS
	Form Factor	<ul style="list-style-type: none"> ◆ Thin Mini ITX Form Factor; 170CM x 170CM
<p>GIGABYTE reserves the right to make any changes to the product specifications and product-related information without prior notice.</p>		

1-3 Installing the Memory



Read the following guidelines before you begin to install the memory:

- Make sure that the motherboard supports the memory. It is recommended that memory of the same capacity, brand, speed, and chips be used.
- Always turn off the computer and unplug the power cord from the power outlet before installing the memory to prevent hardware damage.
- Memory modules have a foolproof design. A memory module can be installed in only one direction. If you are unable to insert the memory, switch the direction.

1-3-1 Installing a Memory

Installation Step:

Step 1. Align the memory with the SO-DIMM module and insert the SO-DIMM memory module into the SO-DIMM slot.

Please note that memory module has a foolproof insertion design. A memory module can be installed in only one direction.

Step 2. Push the memory and seat it firmly.

Step 3. Reverse the installation steps when you wish to remove the SO-DIMM module.

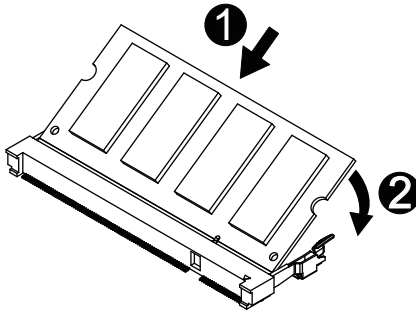

1-4 Back Panel Connectors

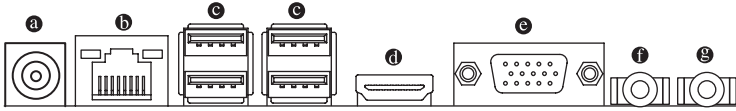

a DC Power Jack

Connect the DC power to this port.

b RJ-45 LAN Port

The Gigabit Ethernet LAN port provides Internet connection at up to 1 Gbps data rate. The following describes the states of the LAN port LEDs.

c USB 3.0 Port

The USB port supports the USB 3.0 specification. Use this port for USB devices such as a USB keyboard/mouse, USB printer, USB flash drive and etc.

d HDMI Port

The HDMI (High-Definition Multimedia Interface) provides an all-digital audio/video interface to transmit the uncompressed audio/video signals and is HDCP compliant. Connect the HDMI audio/video device to this port. The HDMI Technology can support a maximum resolution of 1920x1080p but the actual resolutions supported depend on the monitor being used.



- When After installing the HDMI device, make sure the default device for sound playback is the HDMI device. (The item name may differ by operating system. Refer the figures below for details.), and enter BIOS Setup, then set Onboard VGA output connect to D-SUB/ HDMI under Advanced BIOS Features..
- Please note the HDMI audio output only supports AC3, DTS and 2-channel-LPCM formats. (AC3 and DTS require the use of an external decoder for decoding.)

e Video Port

The video in port allows connect to video in, which can also apply to video loop thru function.

f Line Out (Front Speaker Out/Green)

The default Line Out (Front Speaker Out) jack. Stereo speakers, earphone or front surroundspeakers can be connected to Line Out (Front Speaker Out) jack.

g MIC In (Pink)

The default MIC In jack. Microphone cab be connected to MIC In jack.

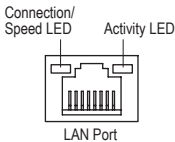

Connection/Speed LED:

State	Description
Orange	1 Gbps data rate
Green	100 Mbps data rate
Off	10 Mbps data rate

Activity LED:

State	Description
Blinking	Data transmission or receiving is occurring
Off	No data transmission or receiving is occurring



- When removing the cable connected to a back panel connector, first remove the cable from your device and then remove it from the motherboard.
- When removing the cable, pull it straight out from the connector. Do not rock it side to side to prevent an electrical short inside the cable connector.

1-5 Internal Connectors

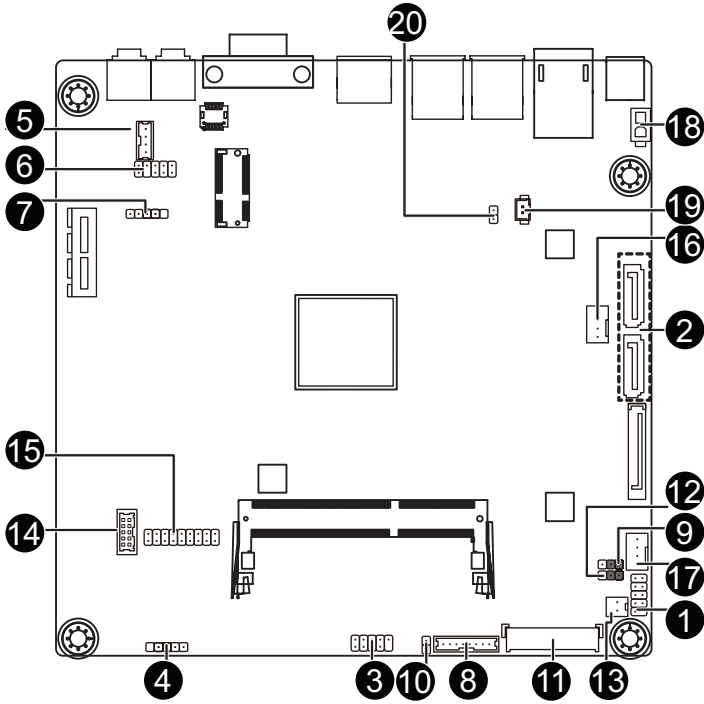

1) SYS_PANEL	11) LVDS
2) SATAII_0/SATAII_1	12) LCD_VCC
3) FUSB2_1	13) MON_SW
4) FUSB2_2	14) COM1
5) SPKR	15) LPT
6) FP_AUDIO	16) CPU_FAN
7) DMIC_CON	17) SYS_FAN
8) FPD	18) ATX_19V
9) FPD_PWR	19) BAT_CON
10) BL_SW	20) CLR_CMOS



Read the following guidelines before connecting external devices:

- First make sure your devices are compliant with the connectors you wish to connect.
- Before installing the devices, be sure to turn off the devices and your computer. Unplug the power cord from the power outlet to prevent damage to the devices.
- After installing the device and before turning on the computer, make sure the device cable has been securely attached to the connector on the motherboard.

1) SYS_PANEL (Front Panel Header)

Connect the power switch, reset switch, speaker, and system status indicator on the chassis to this header according to the pin assignments below. Note the positive and negative pins before connecting the cables.

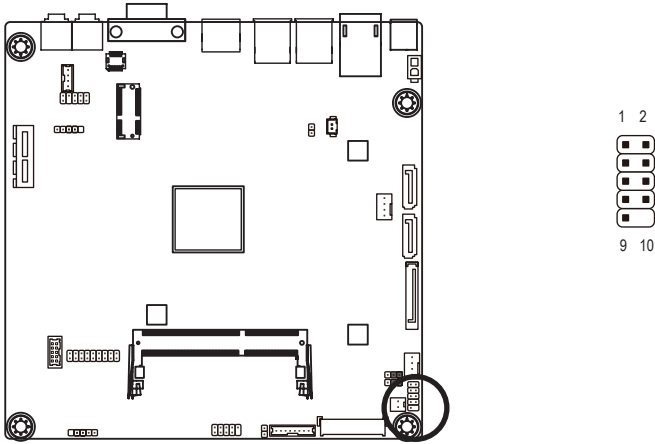

Pin No.	Signal Name	Definition
1	HD+	Hard Disk LED Signal anode (+)
2	MPD+	Power LED Signal anode (+)
3	HD-	Hard Disk LED Signal cathode(-)
4	MPD-	Power LED Signal cathode(-)
5	GND	Ground
6	PW+	Power Button anode (+)
7	RST	Reset Button
8	PW-	Power Button cathode(-)
9	WF_LED	Wifi active LED Signal



The front panel design may differ by chassis. A front panel module mainly consists of power switch, reset switch, power LED, hard drive activity LED, and etc. When connecting your chassis front panel module to this header, make sure the wire assignments and the pin assignments are matched correctly.

2) SATAIII_0/SATAIII_1 (SATA 6Gb/s Connectors)

The SATA connectors conform to SATA 6Gb/s standard and are compatible with SATA 3Gb/s and SATA 1.5Gb/s standard. Each SATA connector supports a single SATA device.

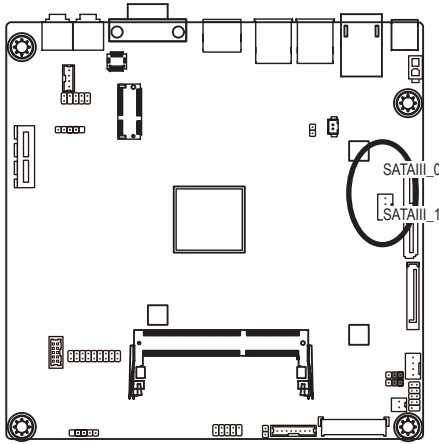

Pin No.	Definition
1	GND
2	TXP
3	TXN
4	GND
5	RXN
6	RXP
7	GND

3/4) FUSB2_1/FUSB2_2 (USB 2.0 Headers)

The headers conform to USB 2.0/1.1 specification. Each USB header can provide two USB ports via an optional USB bracket. For purchasing the optional USB bracket, please contact the local dealer.

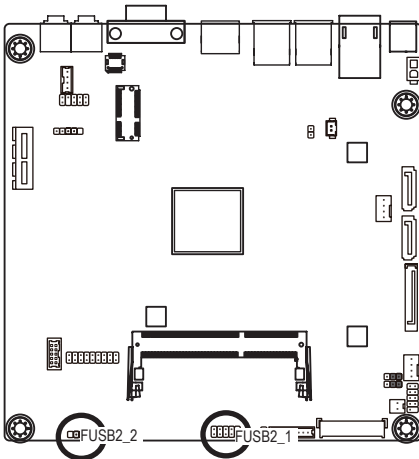

Pin No.	Definition
1	Power (5V)
2	Power (5V)
3	USB DX-
4	USB DY-
5	USB DX+
6	USB DY+
7	GND
8	GND
9	No Pin
10	NC

FUSB2_2



Pin No.	Definition
1	VCC
2	USB-
3	USB+
4	GND
5	No Pin

5) SPKR (Speaker Cable Connector)

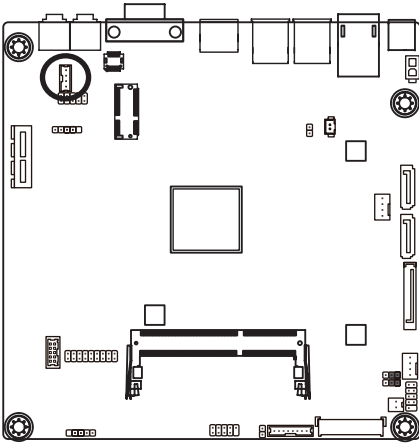

Pin No.	Definition
1	Speaker OUT L-
2	Speaker OUT L+
3	Speaker OUT R+
4	Speaker OUT R-

6) FP_AUDIO (Front Panel Audio Header)

The front panel audio header supports Intel High Definition audio (HD) and AC'97 audio. You may connect your chassis front panel audio module to this header. Make sure the wire assignments of the module connector match the pin assignments of the motherboard header. Incorrect connection between the module connector and the motherboard header will make the device unable to work or even damage it.

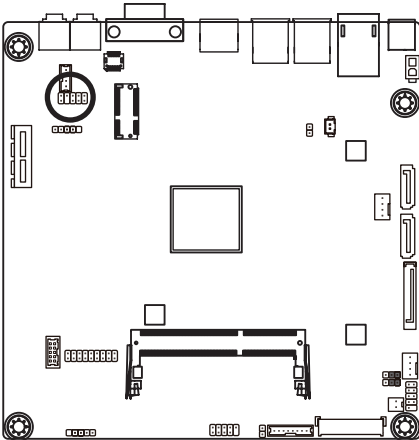

Pin No.	Definition
1	MIC_L
2	GND
3	MIC_R
4	-ACZ_DET
5	HPOUT_R
6	F_MIC_JD
7	GND
8	NC
9	F_LINE2
10	F_LINE_JD

7) DMIC_CON (DMIC Header)

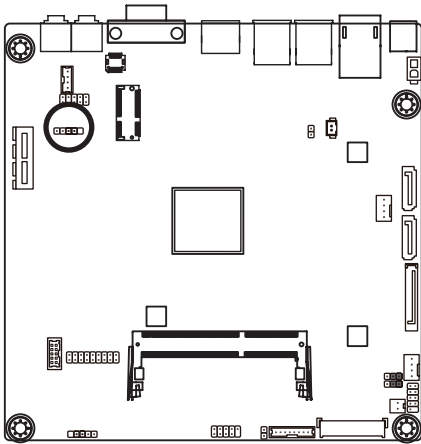

1 

Pin No.	Definition
1	Power
2	DMI DATA
3	GND
4	DMI CLK
5	No Pin

8) FPD (Flat Panel Display Headers)

The FPD is a high-speed interface connecting the output of a video controller in a laptop computer, computer monitor or LCD television set to the display panel. Most laptops, LCD computer monitors and LCD TVs use this interface internally. The headers conform to FPD specification.

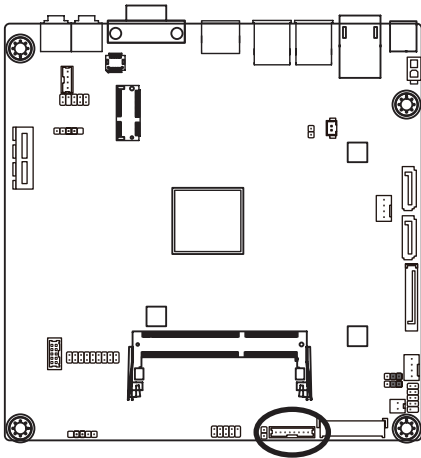



8 

Pin No.	Definition
1	BKLT_EN
2	BKLT_PWM
3	BKLT_PWR
4	BKLT_PWR
5	BKLT_GND/Brightness_GND
6	BKLT_GND/Brightness_GND
7	Brightness_Up
8	Brightness_Down

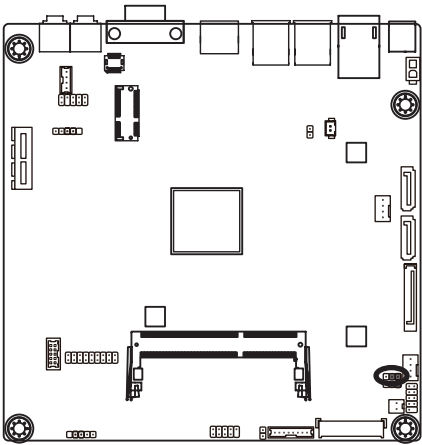
9) FPD_PWR (LVDS Power Select Jumper)



-  1-2 Close: Set to 12V.
-  2-3 Close: Set to 19V. (Default setting)

10) BL_SW (Back Light Switch Header)

The Back Light switch provides the function for screen back light adjustment.

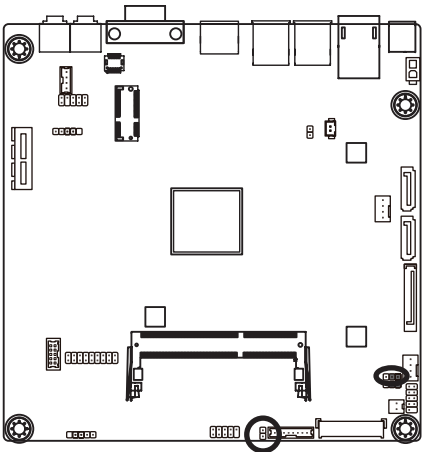

- 2
- 
- 1

Pin No.	Definition
1	BL_DOWN
2	BL_UP

11) LVDS (LVDS Connector)

LVDS stands for Low-voltage differential signaling, which uses high-speed analog circuit techniques to provide multigigabit data transfers on copper interconnects and is a generic interface standard for high-speed data transmission.

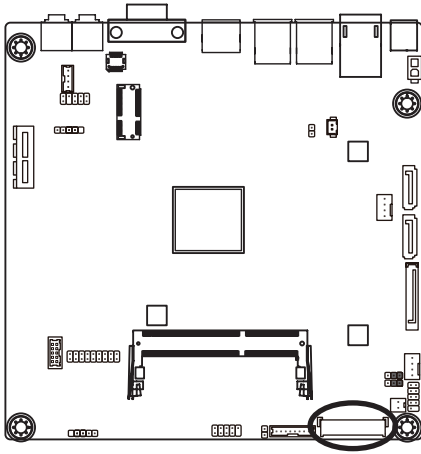

Pin No.	Definition	Pin No.	Definition
1	+RXO3_C	21	NC
2	-RXO3_C	22	VCC3
3	+RXO2_C	23	GND
4	-RXO2_C	24	-LVDS_SENSE
5	+RXO1_C	25	GND
6	-RXO1_C	26	+RXECLKO_C
7	+RXO0_C	27	-RXECLKO_C
8	-RXO0_C	28	GND
9	+RXE3_C	29	GND
10	-RXE3_C	30	GND
11	+RXE2_C	31	SCL1
12	-RXE2_C	32	SC_BKLT_EN
13	+RXE1_C	33	SC_BKLTCTL
14	-RXE1_C	34	+RXECLKE_C
15	+RXE0_C	35	-RXECLKE_C
16	-RXE0_C	36	FPD_19V
17	GND	37	FPD_19V
18	LCD_VCC	38	FPD_19V
19	LCD_VCC	39	NC
20	LCD_VCC	40	SDA1

12) LCD_VCC (LVDS Drive Voltage Jumper)

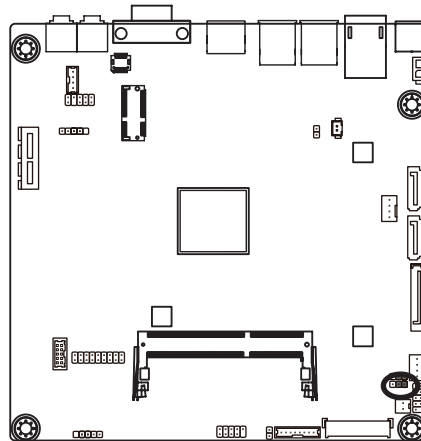

1  1-2 Close: Set to 3V.

1  2-3 Close: Set to 5V. (Default setting)

13) MON_SW (Monitor Power Switch Header)

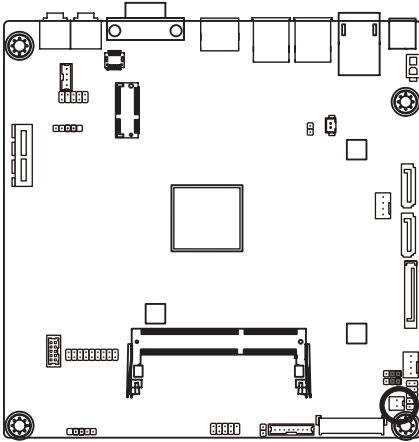

Pin No.	Definition
1	High: turn on monitor
2	Low: turn off monitor

14) COM1 (Serial Port 1 Cable Connector)

The COM header can provide one serial port via an optional COM port cable. For purchasing the optional COM port cable, please contact the local dealer.

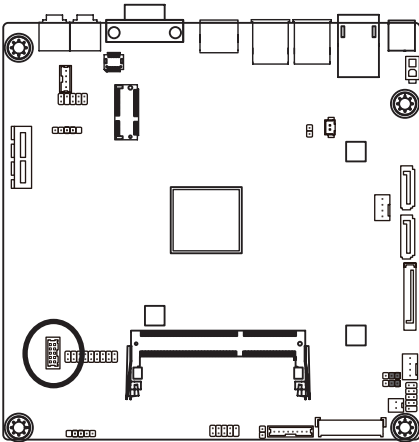

Pin No.	Definition
1	NCCDA-
2	NDSRA-
3	NRXDA-
4	NRTSA-
5	NTXDA-
6	NCTSA-
7	NDTRA-
8	RI-_12V_5V
9	GND
10	NC

15) LPT (Parallel Port Cable Header)

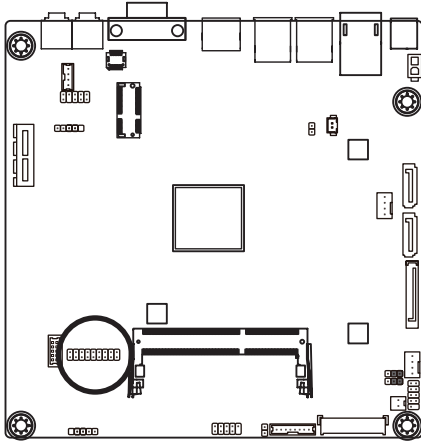

Pin No.	Definition	Pin No.	Definition
1	LPT1	11	LPT6
2	BUSY	12	LPT16
3	LPT2	13	LPT7
4	PE	14	LPT47
5	LPT3	15	LPT8
6	SLCT	16	GND
7	LPT4	17	LPT9
8	LPT14	18	GND
9	LPT5	19	ACK-
10	ERR-	20	GND

16/17) CPU_FAN/SYS_FAN (CPU Fan/System Fan Header)

The motherboard has one 4-pin CPU fan header, and one 4-pin system fan header. Most fan headers possess a foolproof insertion design. When connecting a fan cable, be sure to connect it in the correct orientation (the black connector wire is the ground wire). The motherboard supports CPU fan speed control, which requires the use of a CPU fan with fan speed control design. For optimum heat dissipation, it is recommended that a system fan be installed inside the chassis.

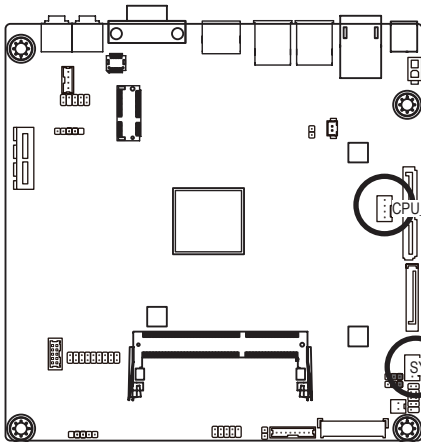

Pin No.	Definition
1	GND
2	+12V
3	Sense
4	Speed Control



- Be sure to connect fan cables to the fan headers to prevent your CPU and system from overheating. Overheating may result in damage to the CPU or the system may hang.
- These fan headers are not configuration jumper blocks. Do not place a jumper cap on the headers.

18) ATX_19V (2 Pin Power Connector)

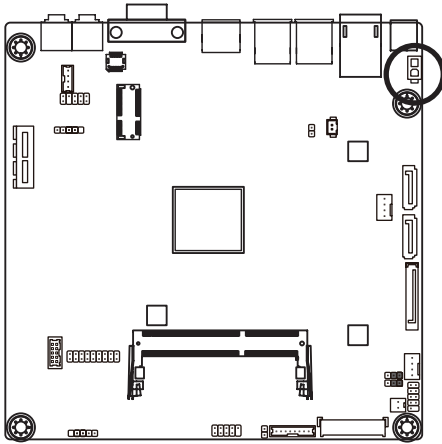

Pin No.	Definition
1	GND
2	+19V

19) BAT_CON (Battery Cable Connector)

The battery provides power to keep the values (such as BIOS configurations, date, and time information) in the CMOS when the computer is turned off. Replace the battery when the battery voltage drops to a low level, or the CMOS values may not be accurate or may be lost.

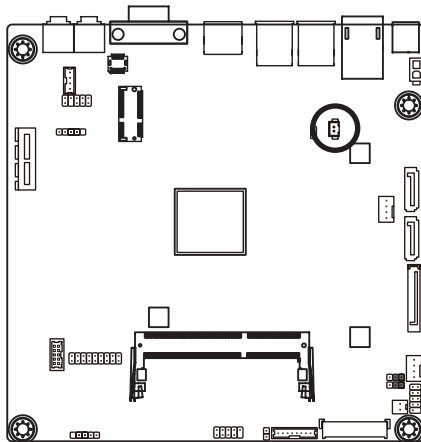

Pin No.	Definition
1	RTC Reset
2	GND



- Always turn off your computer and unplug the power cord before replacing the battery.
- Replace the battery with an equivalent one. Danger of explosion if the battery is replaced with an incorrect model.
- Contact the place of purchase or local dealer if you are not able to replace the battery by yourself or uncertain about the battery model.
- Used batteries must be handled in accordance with local environmental regulations.

20) CLR_CMOS (Clearing CMOS Jumper)

Use this jumper to clear the CMOS values (e.g. date information and BIOS configurations) and reset the CMOS values to factory defaults. To clear the CMOS values, place a jumper cap on the two pins or temporarily short the two pins or use a metal object like a screwdriver to touch the two pins for a few seconds.

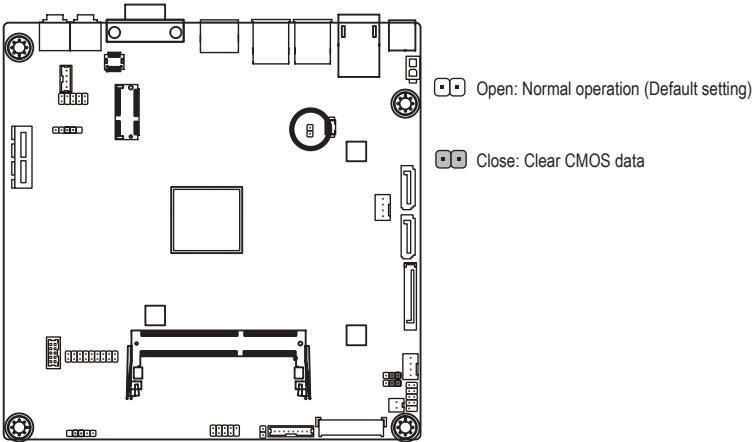

Chapter 2 BIOS Setup

BIOS (Basic Input and Output System) records hardware parameters of the system in the CMOS on the motherboard. Its major functions include conducting the Power-On Self-Test (POST) during system startup, saving system parameters and loading operating system, etc. BIOS includes a BIOS Setup program that allows the user to modify basic system configuration settings or to activate certain system features. When the power is turned off, the battery on the motherboard supplies the necessary power to the CMOS to keep the configuration values in the CMOS.

To access the BIOS Setup program, press the key during the POST when the power is turned on.



- BIOS flashing is potentially risky, if you do not encounter problems of using the current BIOS version, it is recommended that you don't flash the BIOS. To flash the BIOS, do it with caution. Inadequate BIOS flashing may result in system malfunction.
- It is recommended that you not alter the default settings (unless you need to) to prevent system instability or other unexpected results. Inadequately altering the settings may result in system's failure to boot. If this occurs, try to clear the CMOS values and reset the board to default values. (Refer to the "Restore Defaults" section in this chapter or introductions of the battery/clearing CMOS jumper in Chapter 1 for how to clear the CMOS values.)

BIOS Setup Program Function Keys

<↑><↓>	Move the selection bar to select an item
<←><→>	Move the selection bar to select the screen
<Enter>	Execute command or enter the submenu
<Esc>	Main Menu: Exit the BIOS Setup program Submenus: Exit current submenu
<+>	Increase the numeric value or make changes
<->	Decrease the numeric value or make changes
<F1>	General Help
<F2>	Restore the previous BIOS settings for the current submenus
<F3>	Load the Optimized BIOS default settings for the current submenus
<F4>	Save all the changes and exit the BIOS Setup program

- **Main**

This setup page includes all the items in standard compatible BIOS

- **Advanced**

This setup page includes all the items of AMI BIOS special enhanced features.

(ex: Auto detect fan and temperature status, automatically configure hard disk parameters.)

- **Chipset**

Northbridge and Southbridge additional features configuration.

- **Boot**

This setup page provides items for configuration of boot sequence.

- **Security**

Change, set, or disable supervisor and user password. Configuration supervisor password allows you to restrict access to the system and BIOS Setup.

A supervisor password allows you to make changes in BIOS Setup.

A user password only allows you to view the BIOS settings but not to make changes.

- **Save & Exit**

Save all the changes made in the BIOS Setup program to the CMOS and exit BIOS Setup.

Abandon all changes and the previous settings remain in effect. Pressing <Y> to the confirmation message will exit BIOS Setup. (Pressing <Esc> can also carry out this task.)

2-1 The Main Menu

Once you enter the BIOS Setup program, the Main Menu (as shown below) appears on the screen. Use arrow keys to move among the items and press <Enter> to accept or enter other sub-menu.

Main Menu Help

The on-screen description of a highlighted setup option is displayed on the bottom line of the Main Menu.

Submenu Help

While in a submenu, press <F1> to display a help screen (General Help) of function keys available for the menu. Press <Esc> to exit the help screen. Help for each item is in the Item Help block on the right side of the submenu.



- When the system is not stable as usual, select the **Restore Defaults** item to set your system to its defaults.
- The BIOS Setup menus described in this chapter are for reference only and may differ by BIOS version.



☞ **BIOS Information**

☞ **Project Name**

Display name of the project.

☞ **BIOS Version**

Display version number of the BIOS.

☞ **BIOS Build Date and Time**

Displays the date and time when the BIOS setup utility was created.

☞ **LAN MAC Address**

Displays the LAN MAC address information.

☞ **Memory Information**

☞ **Total Memory**

Display the total memory size of the installed memory.

☞ **TXE FW Version**

Display the TXE firmware version.

☞ **System Date**

Set the date following the weekday-month-day- year format.

☞ **System Time**

Set the system time following the hour-minute- second format.

2-2 Advanced Menu

The Advanced menu display submenu options for configuring the function of various hardware components. Select a submenu item, then press Enter to access the related submenu screen.



2-2-1 Super IO Configuration

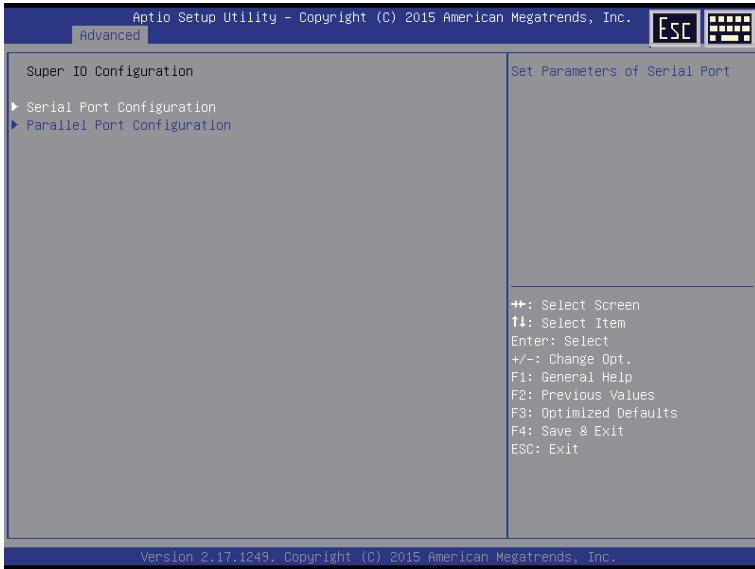

☞ Super IO Configuration

☞ Serial Port Configuration

Press [Enter] for configuration of advanced items.

☞ Parallel Port Configuration

Press [Enter] for configuration of advanced items.

2-2-1-1 Serial Port Configuration

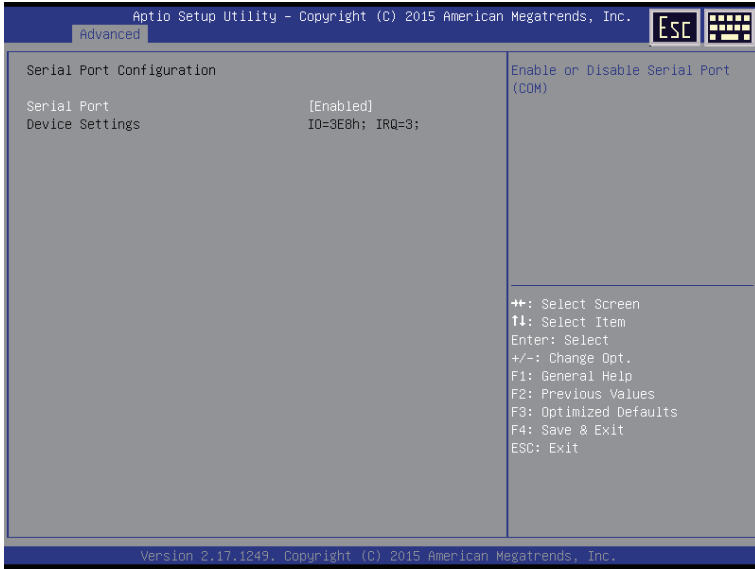

☞ Serial Port Configuration

☞ Serial Port

When enabled allows you to configure the serial port settings. When set to Disabled, displays no configuration for the serial port.

Options available: Enabled/Disabled. Default setting is **Enabled**.

☞ Device Settings

Display the specified Serial Port base I/O address and IRQ.

2-2-1-2 Parallel Port Configuration

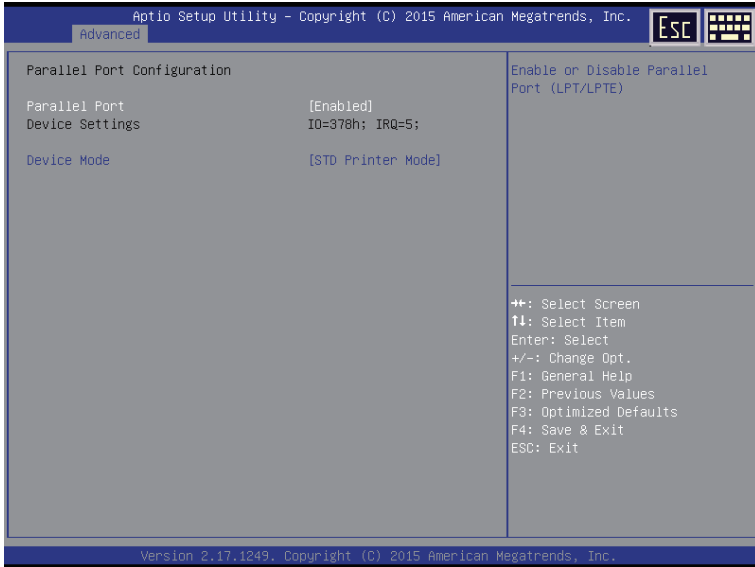

☞ Parallel Port

When enabled allows you to configure the parallel settings.

Options available: Enabled/Disabled. Default setting is **Enabled**.

☞ Device Settings

Display the specified Parallel port base I/O address and IRQ.

☞ Device Mode

Configure parallel port mode.

STD Printer Mode: Similar to Standard Parallel Port mode, but STD Printer Mode only provides one direction data flow communication.

Standard Parallel Port mode (SPP): SPP stands for Standard Parallel Port. Differ from Standard (STD) Printer Mode is this mode provides bi-direction data flow communication. Set this item to SPP Mode, system will transfer protocol for the parallel port. It works all parallel devices.

EPP Mode: Enhanced Parallel Port using existing parallel port signals to provide a asymmetric bidirectional communication. It's offering transfer rates of up to 2MB/s.

ECP Mode: The Extended Capabilities Port transfer mode uses DMA protocol to achieve data transfer rates of up to 2MB/s and provides symmetric bidirectional communication.

EPP -1.9 and SPP Mode: Enable EPP 1.9 and SPP Mode.

EPP -1.7 and SPP Mode: Enable EPP 1.7 and SPP Mode.

ECP and EPP 1.9 Mode: Enable ECP and EPP 1.9 Mode.

ECP and EPP 1.7 Mode: Enable ECP and EPP 1.7 Mode.

Options available: STD Printer Mode/SPP Mode/EPP 1.9 and SPP Mode/EPP 1.7 and SPP Mode/
ECP Mode/ECP and EPP 1.9 Mode/ECP and EPP 1.7 Mode.

Default setting is **STD Printer Mode**.

2-2-2 Hardware Monitor

Press Enter to view the Hardware Monitor screen which displays a real-time record of the CPU/system temperature, and fan speed, Items on this window are non-configurable.

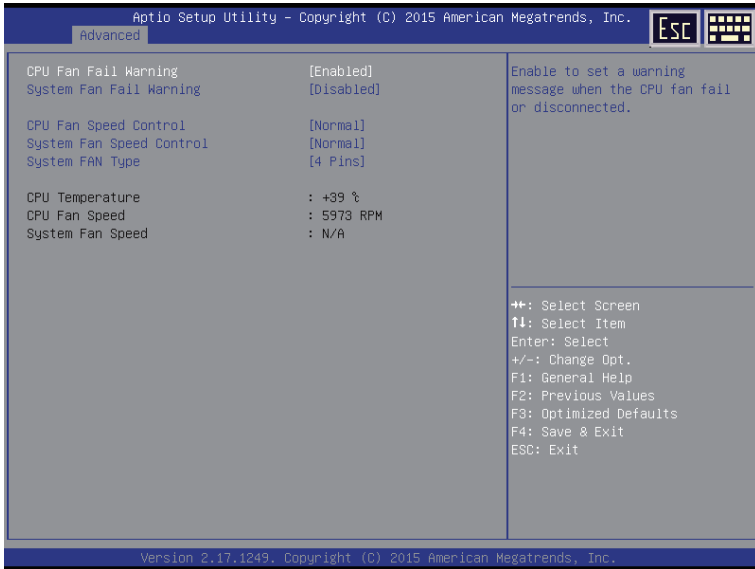

☞ PC Health Status

☞ CPU/System FAN Fail Warning

Enable/Disable CPU/System FAN Fail warning alert function.

Option available: Enabled/Disabled.

Default setting for CPU FAN Fail Warning is **Enabled**.

Default setting for System FAN Fail Warning is **Disabled**.

☞ CPU/System FAN Speed Control

Enable CPU/System Fan Speed Control function.

Option available: Normal/Full Speed. Default setting is **Normal**.

☞ SYS FAN Type

Select system fan type.

Option available: 3 Pin/4 Pin. Default setting is **4 Pin**.

☞ CPU Temperature

Displays current CPU temperature.

☞ CPU/System Fan Speed (RPM)

Displays current CPU and system fan speed.

2-2-3 S5 RTC Wake Settings

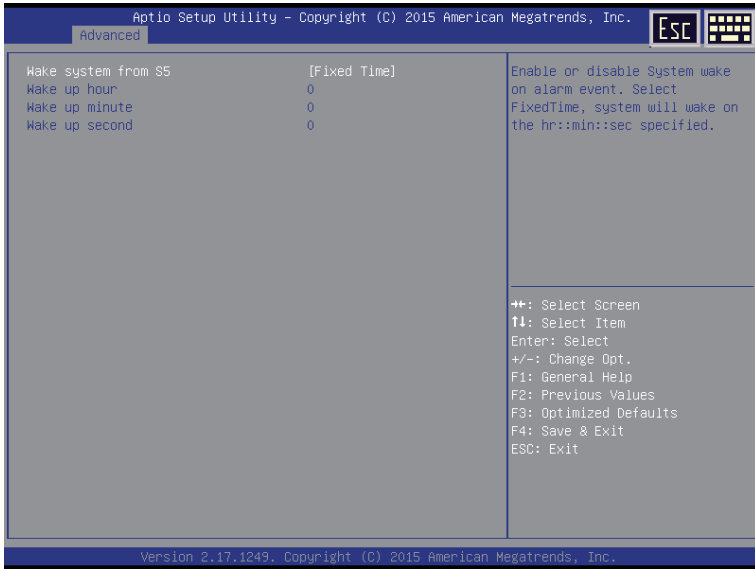

☞ **Wake system from S5**

Enable or disable System wake on alarm event. When enabled, System will wake on the hr:min:sec specified. Default setting is **Disabled**.

☞ **Wake up hour^(Note)**

Press <+> and <-> to define the wake up hour.

☞ **Wake up minute^(Note)**

Press <+> and <-> to define the wake up minute.

☞ **Wake up second^(Note)**

Press <+> and <-> to define the wake up second.

(Note) This item appears when **Wake system from S5** is set to **Fixed time**.

2-2-4 CPU Configuration

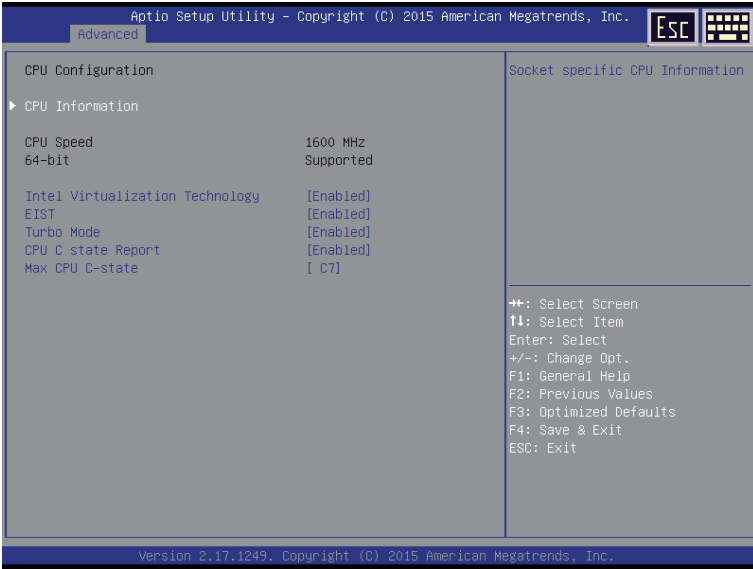

☞ CPU Information

Press [Enter] to view the installed CPU information.

☞ Intel Virtualization Technology

Select whether to enable the Intel Virtualization Technology function. VT allows a single platform to run multiple operating systems in independent partitions.

Options available: Enabled/Disabled. Default setting is **Enabled**.

☞ EIST (Enhanced Intel SpeedStep Technology)

Conventional Intel SpeedStep Technology switches both voltage and frequency in tandem between high and low levels in response to processor load.

Options available: Enabled/Disabled. Default setting is **Enabled**.

☞ Turbo Mode

When this feature is enabled, the processor can dynamically overclock one or two of its four processing cores to improve performance with applications that are not multi-threaded or optimized for quad-core processors.

Options available: Enabled/Disabled. Default setting is **Enabled**.

☞ CPU C State Report

Enable/Disable CPU C State report function.

Options available: Enabled/Disabled. Default setting is **Enabled**.

☞ Max CPU C-state

Define CPU C-State.

Options available: C7/C6. Default setting is **C7**.

2-2-4-1 CPU Information



☞ **CPU Type/Signature/Microcode Path/Processor Cores/Intel HT Technology/
Intel VT-x Technology**

Displays the technical specifications for the installed processor.

☞ **Cache Information**

☞ **L1 Data Cache / L1 Code Cache / L2 Cache / L3 Cache**

Displays the technical specifications for the installed processor.

2-2-5 SATA Configuration

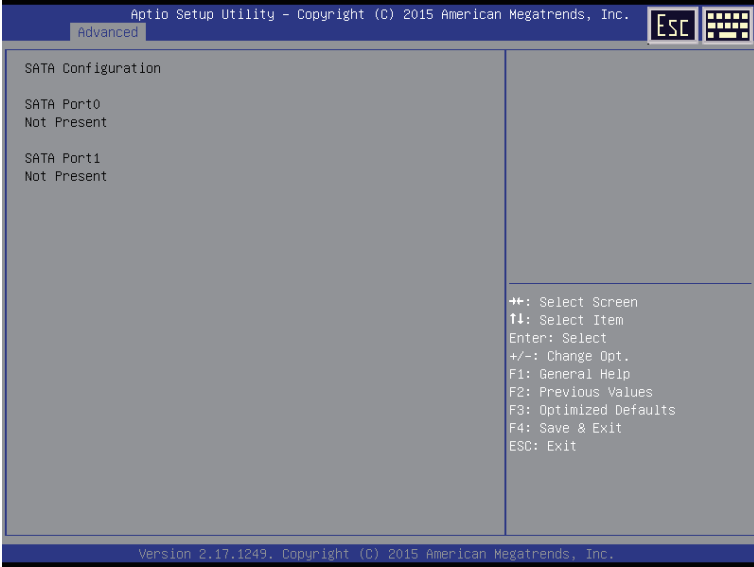

☞ SATA Mode Selection

Select the on chip SATA type.

IDE Mode: When set to IDE, the SATA controller disables its AHCI functions and runs in the IDE emulation mode.

AHCI Mode: When set to AHCI, the SATA controller enables its AHCI functionality.

Options available: IDE/AHCI/Disabled. Default setting is **AHCI Mode**.

☞ SATA Port 0/1

Displays the installed HDD devices information. System will automatically detect HDD type.

☞ Hot Plug (for Serial SATA Port 0/1/2/3/4/5)

Enable/Disable Hot Plug support for Serial ATA Port 0/1.

Options available: Enabled/Disabled. Default setting is **Disabled**.

☞ External SATA Chip

The category identifies Serial ATA and mSATA types of hard disk that are installed in the computer. System will automatically detect HDD type.

Note that the specifications of your drive must match with the drive table. The hard disk will not work properly if you enter improper information for this category.

Hard drive information should be labeled on the outside device casing. Enter the appropriate option based on this information.

2-2-6 OS Selection

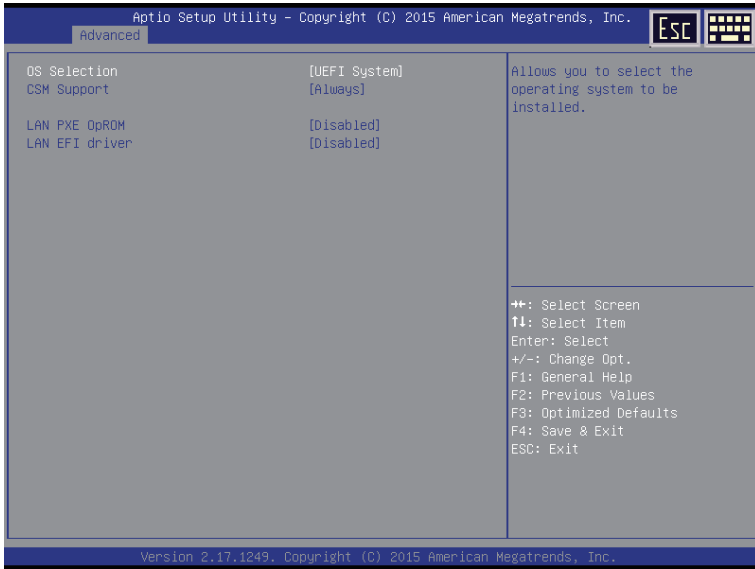

☞ OS Selection

Option Available: UEFI System/Legacy System/Linux System. Default setting is **UEFI System**.

☞ CSM Support

Determine Compatibility Support Module (CSM) support function.

Options available: Never/Always. Default setting is **Always**.

☞ LAN PXE OpROM

Enable/Disable LAN PXE OpROM.

Options available: Enabled/Disabled. Default setting is **Disabled**.

☞ LAN EFI driver

Enable/Disable LAN EFI driver.

Options available: Enabled/Disabled. Default setting is **Disabled**.

2-3 Chipset Menu

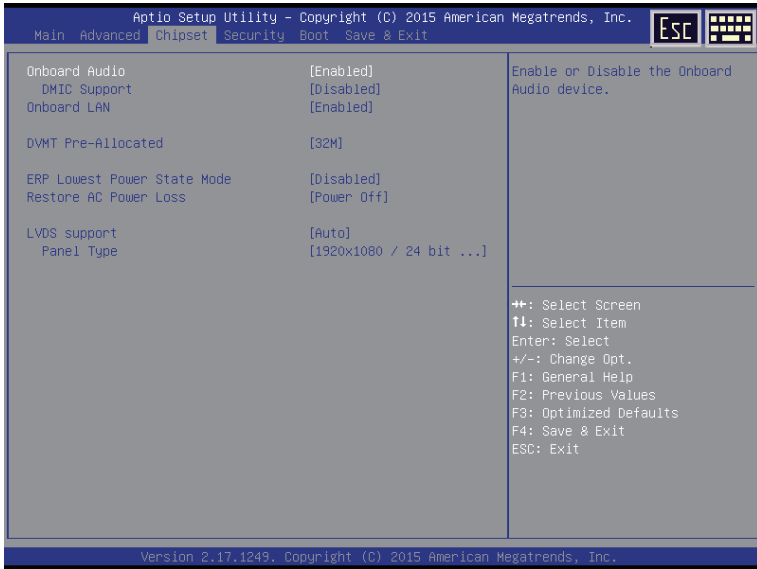

☞ Onboard Audio

Enable/Disable onboard audio controller.

Options available: Enabled/Disabled. Default setting is **Enabled**.

☞ DMIC Support

Enable/Disable DMIC Support

Options available: Enabled/Disabled. Default setting is **Disabled**.

☞ Onboard LAN

Enable/Disable onboard LAN controller.

Options available: Enabled/Disabled. Default setting is **Enabled**.

☞ DVMT Pre-Allocated

Select DVMT 5.0 Pre-Allocated (Fixed) Graphics Memory size used by the Internal Graphics Device.

Options available: 64M/128M/192M/256M/320M/384M/512M. Default setting is **64M**.

☞ ERP Lowest Power State Mode

Enable/Disable ERP Lowest Power State Mode.

Options available: Enabled/Disabled. Default setting is **Disabled**.

☞ Restore AC Power Loss

This option provides user to set the mode of operation if an AC / power loss occurs.

Power On: System power state when AC cord is re-plugged.

Power Off: Do not power on system when AC power is back.

Last State: Set system to the last state when AC power is removed.

Options available: Power On/Power Off/Last State. Default setting is **Power Off**.

☞ **LVDS Support**

Enable/Disable LVDS function.

Options available: Auto/Enabled/Disabled. Default setting is **Auto**.

☞ **Panel Type**

Selecting by Internal Graphics Device by selecting appropriate setup item.

Options available:

800 x 480/18 bit /Single channel; 800 x 600/18 bit /Single channel;

1024 x 600/18 bit /Single channel; 1024 x 768/18 bit /Single channel; 1024 x 768/24 bit /Single channel

1280 x 800/24 bit /Single channel; 1280 x 1024/18 bit /Dual channel; 1280 x 1024/24 bit /Dual channel;

1366 x 768/18 bit /Single channel; 1366 x 768/24 bit /Single channel;

1600 x 900/18 bit /Dual channel; 1600 x 900/24 bit /Dual channel;

1920 x 1800/18 bit/Dual channel; 1920 x 1800/24 bit/Dual channel; 1920 x 1200/24 bit/Dual channel;

Other

2-4 Security Menu

The Security menu allows you to safeguard and protect the system from unauthorized use by setting up access passwords.

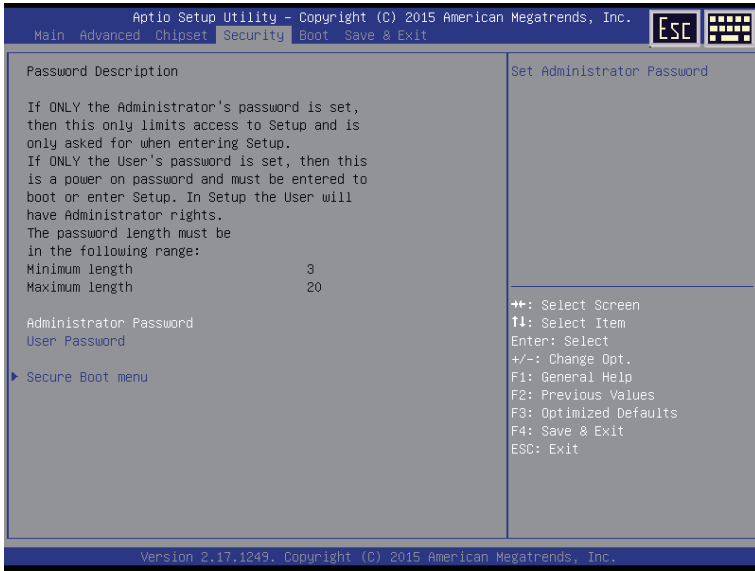

There are two types of passwords that you can set:

- **Administrator Password**
Entering this password will allow the user to access and change all settings in the Setup Utility.
- **User Password**
Entering this password will restrict a user's access to the Setup menus. To enable or disable this field, a Administrator Password must first be set. A user can only access and modify the System Time, System Date, and Set User Password fields.

⚙ **AdministratorPassword**

Press Enter to configure the Administrator password.

⚙ **User Password**

Press Enter to configure the user password.

⚙ **Secure Boot menu**

Press [Enter] for configuration of advanced items.

2-4-1 Secure Boot menu

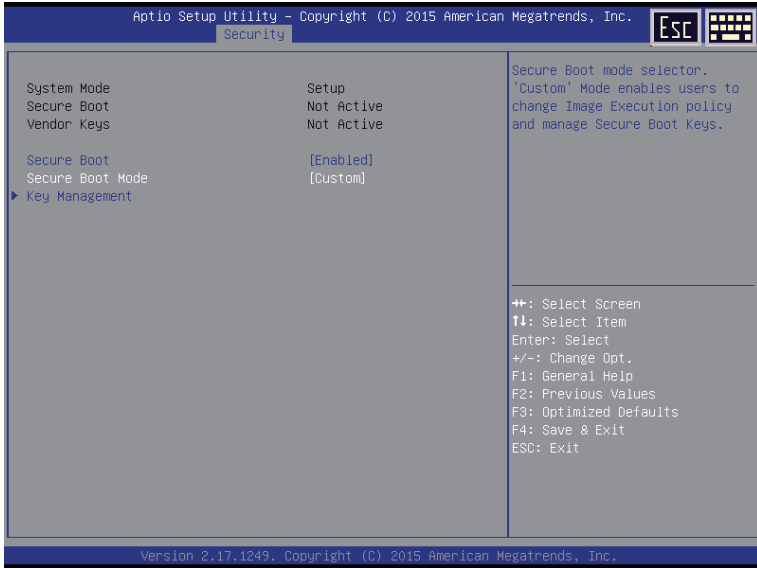

System Mode

Display the System Mode state.

Secure Boot

Display the System Mode State.

Vendor Keys

Display the Vendor Keys information.

Secure Boot

Secure Boot requires all the applications that are running during the booting process to be pre-signed with valid digital certificates. This way, the system knows all the files being loaded before Windows 8 loads and gets to the login screen have not been tampered with.

Options available: Enabled/Disabled. Default setting is **Disabled**.

Secure Boot Mode^(Note)

Define the Secure Boot Mode. Set this item to **Custom** to advanced items configuration.

Option available: Standard/Custom. Default setting is **Custom**.

Key Management

Press Enter to configure the advanced items.

(Note) Advanced items prompt when this item is set to **Custom**.

2-4-1-1 Key Management

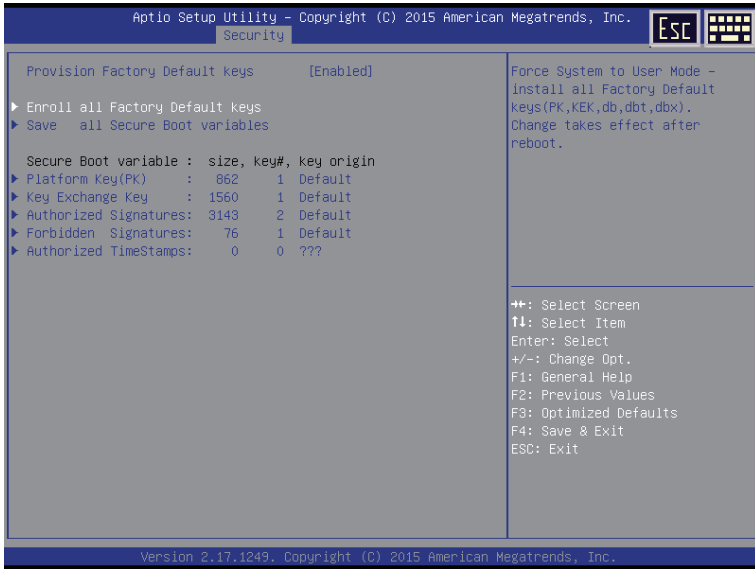

Key Management

This item appears only when the **Secure Boot Mode** is set to **Custom**.

Provision Factory Default Keys

Force the system to Setup Mode. This will clear all Secure Boot Variables such as Platform Key (PK), Key-exchange Key (KEK), Authorized Signature Database (db), and Forbidden Signatures Database (dbx).

Options available: Enabled/Disabled. Default setting is **Disabled**.

Enroll All Factory Default Keys

Press [Enter] to install all factory default keys.

Save All Secure Boot Variables

Press [Enter] to save all Secure Boot Variables.

Platform Key (PK)

Press Enter to configure the advanced items.

Key Exchange Key

Press Enter to configure the advanced items.

Authorized Signature

Press Enter to configure the advanced items.

Forbidden Signature

Press Enter to configure the advanced items.

Authorized TimeStamps

Press Enter to configure the advanced items.

2-5 Boot Menu

The Boot menu allows you to set the drive priority during system boot-up. BIOS setup will display an error message if the drive(s) specified is not bootable.

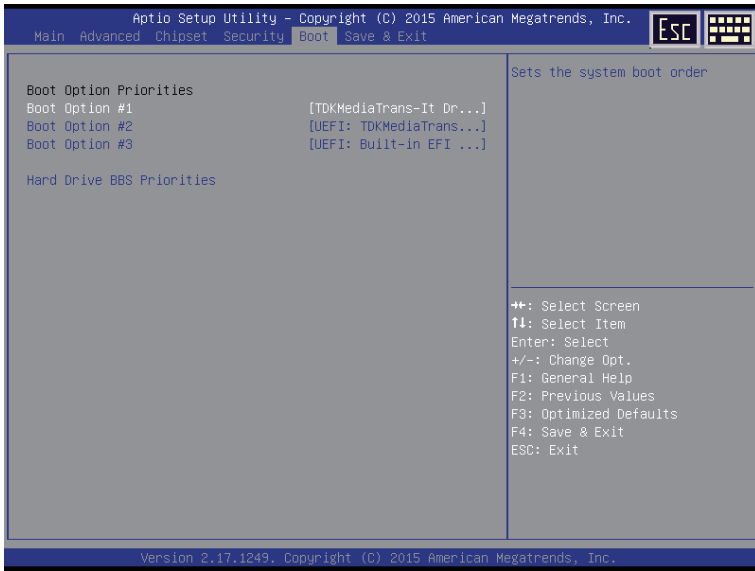

🔗 Boot Configuration

🔗 Boot Option Priorities

🔗 Boot Option #1/#2#3

Press Enter to configure the boot priority.

By default, the server searches for boot devices in the following sequence:

1. UEFI device.
2. Hard drive.
3. Network device.

🔗 Hard Drive BBS Priorities

Press Enter to configure the boot priority.

2-6 Save & Exit Menu

The Exit menu displays the various options to quit from the BIOS setup. Highlight any of the exit options then press **Enter**.

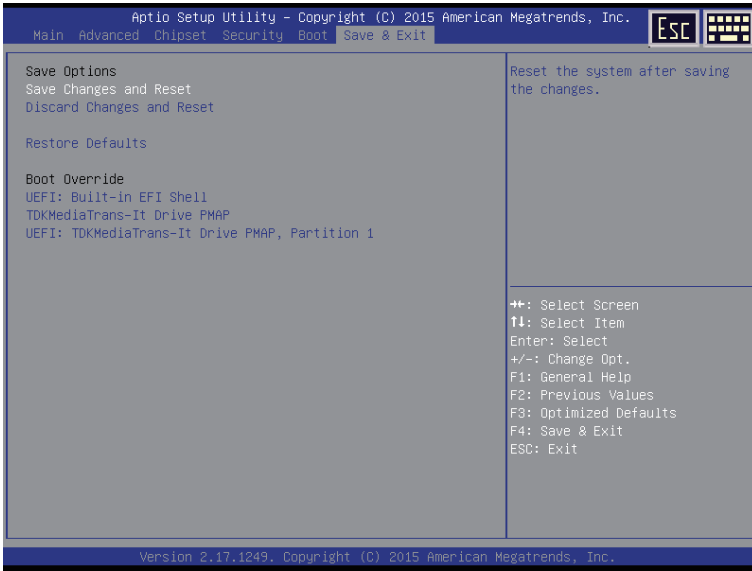

Save Changes and Reset

Saves changes made and close the BIOS setup.

Options available: Yes/No.

Discard Changes and Reset

Discards changes made and close the BIOS setup.

Options available: Yes/No.

Restore Defaults

Loads the default settings for all BIOS setup parameters. Setup Defaults are quite demanding in terms of resources consumption. If you are using low-speed memory chips or other kinds of low-performance components and you choose to load these settings, the system might not function properly.

Options available: Yes/No.

Boot Override

Press Enter to configure the device as the boot-up drive.

UEFI: Built-in in EFI Shell

Press <Enter> on this item to Launch EFI Shell from filesystem device.