

GIGABYTE™

P2532

USER'S MANUAL

使 用 手 冊

● English

V2.0



* Images Used for Reference Only

Congratulations on your purchase of the GIGABYTE Notebook P2532.

This Manual will help you to get started with setting up your notebook. For more detailed information, please visit our website at <http://www.gigabyte.com>.

All specifications are subject to the manufacturer's configuration at the time of shipping and may change without prior notice, written or otherwise.

1 Check Supplied Items

AC Adapter

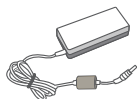

Battery Pack

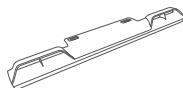

Manual

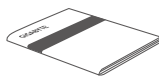

3D Glasses
(Optional)



Power Cord

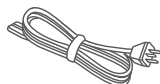

Driver CD

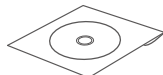

Global Warranty
Card



* The illustrations in this document may appear differently from your model.

2 Using GIGABYTE Notebook for the First Time

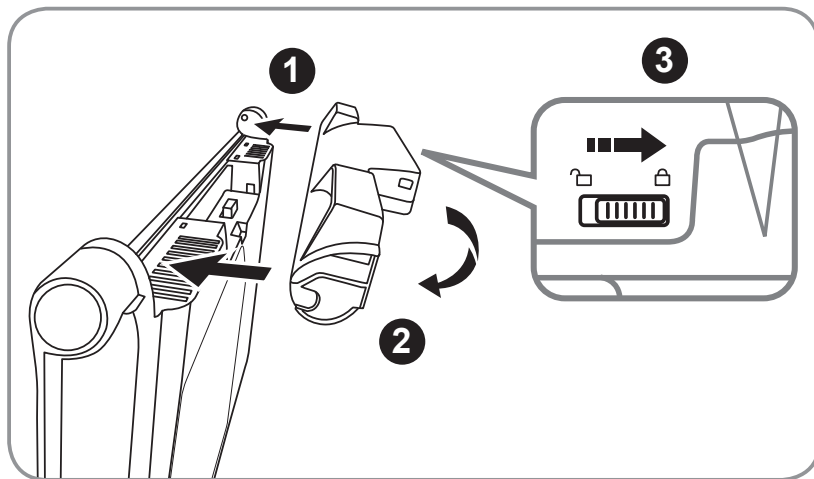

To install the battery please follow these steps:

- 1 Target the battery's direction into the tenon-mortise.
- 2 Circulate the battery downwards until hearing the "snap" sound to lock the battery.
- 3 Remember to slide the switch to the "Lock" position.

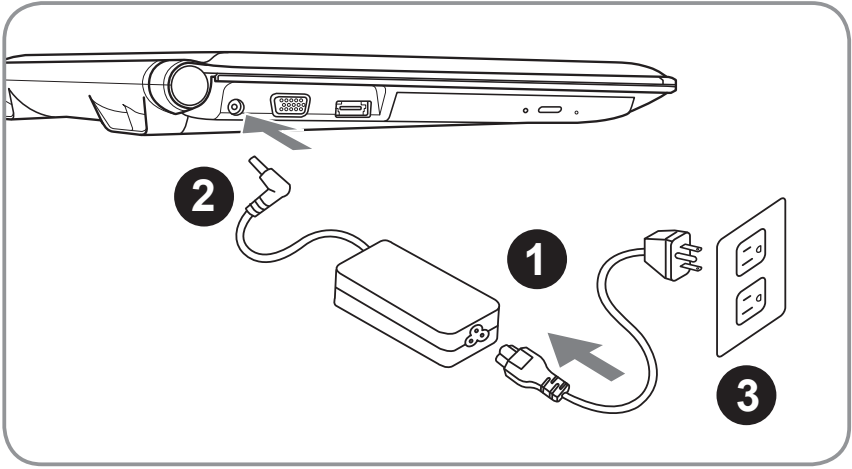

- 1 Connect the the power cord to the AC adapter.
- 2 Connect the AC adapter to the DC-in jack on the left side of the notebook.
- 3 Connect the power cord to the power outlet.

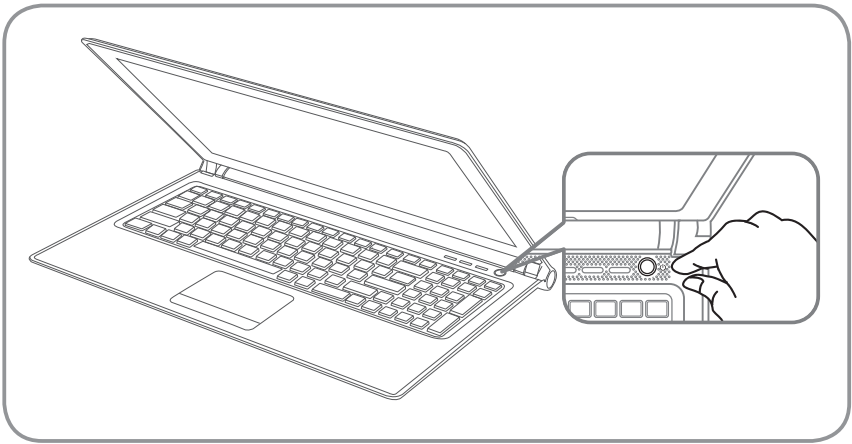

Switching on the Power

After you turn on the P2532 for the very first time, do not turn it off until the operating system has been configured. Please note that the volume for the audio will not function until Windows Setup has completed.

Booting Up the P2532 for the First Time

Depending on your configuration, the Microsoft Windows Boot Screen will be the first screen that you will see as the notebook starts up. Follow the on-screen prompts and instructions and enter your personal information to complete the setup of the Windows Operating System.

3 Your GIGABYTE Notebook Tour

Top View

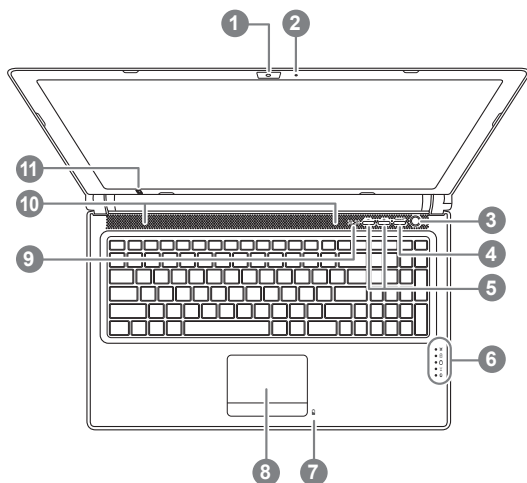

- 1** Webcam
- 2** Microphone
- 3** Power Button
- 4** Smart+ Button **①**
- 5** Volume Setting or Stereoscopic Depth Setting **②**
- 6** LED Indicators **③**
- 7** Battery Indicator Button
- 8** TouchPad
- 9** Num Lock & Caps Lock Indicator
- 10** Stereo speakers
- 11** IR Emitter Optional **④**

- ①** To call out smart manager function. Smart Setup– Under off condition, Push “Smart+” to enter “smart setup” menu in off mode. You can choose BIOS Setup Utility system recovery in the setup menu. Smart Manager– In Windows Mode Press “Smart +” button to initiate “Smart Manager”.
- ②** Optional, Stereoscopic Depth Setting for 3D model Use only
- ③**
 - ☼ Power Status LED
 - ☒ Battery Status LED
 - ☐ HDD Status LED
 - ☏ Wireless Lan Status LED
 - Ⓜ Bluetooth Status LED

Left View

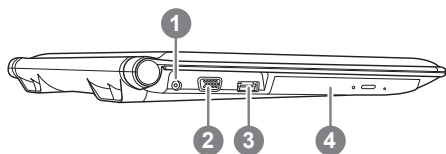

- 1** DC-in Jack
- 2** External Display (VGA) Port
- 3** eSATA/USB Combo
- 4** Optical Disc Drive

Right View

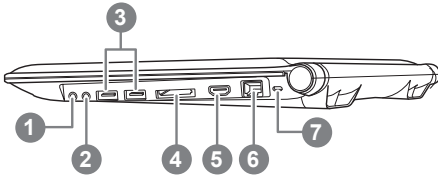

- 1** Microphone Jack
 - 2** Headphone Jack
 - 3** USB Port x 2
 - 4** Multi Card Reader ^④
 - 5** HDMI Port
 - 6** Ethernet Port
 - 7** Kensington Lock Slot
- ^④ Supports Secure Digital (SD), Multi Media Card (MMC), Memory Stick (MS), Memory Stick PRO (MS PRO).

Base View

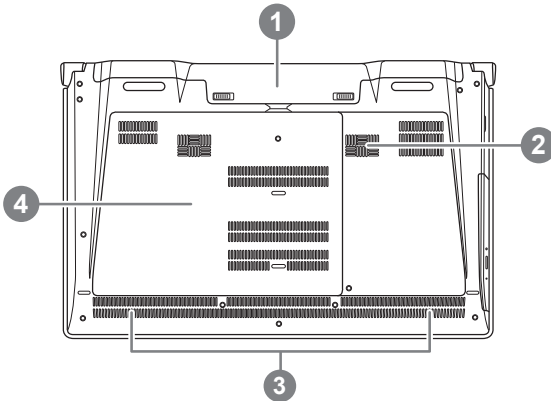

- 1** Battery Bay
- 2** Woofer Speaker
- 3** Stereo Speakers
- 4** Hard Disk Bay/Memory Bay

3D Vision Glasses (Optional, for 3D Model Use Only)

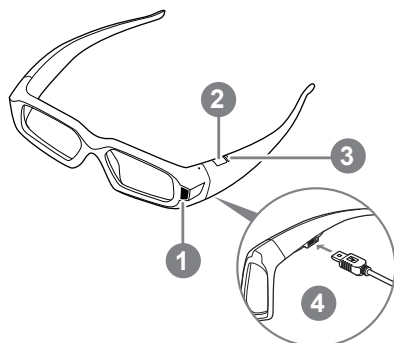

- 1 IR Receiver
- 2 On Button
- 3 Indicator Light
- 4 Mini USB Connection

- 5 Note: Flashing red indicates less than two hours of charge remaining.
- 6 After connecting the charged glasses. (Light is amber when charging)

Keyboard

The P2532 features a Windows Compatible Keyboard.

The set language of the keyboard will depend on the region. This section is for the English Qwerty Keyboard layout. The number of keys on the keyboard will also vary by language and region.

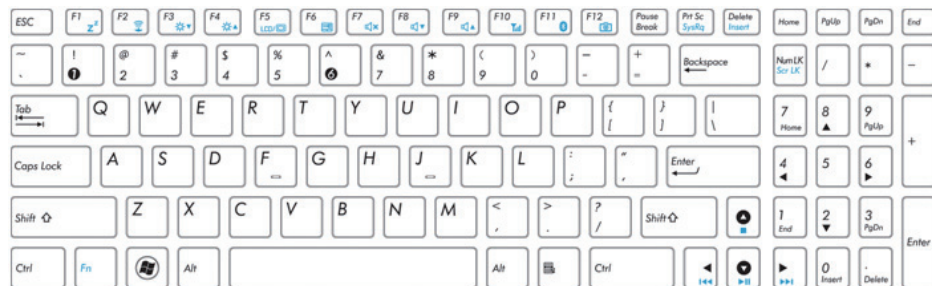













(English P2532 QWERTY Keyboard Layout)

Hotkeys

The computer employs hotkeys or key combinations to access most of the computer's controls like screen brightness and volume output.

To activate hotkeys, press and hold the <Fn> key before pressing the other key in the hotkey combination.

Hotkey	Function	Description
Fn+F1 	Sleep	Puts the computer in Sleep mode.
Fn+F2 	Wireless LAN	Enables/disables the Wireless LAN function.
Fn+F3 	Brightness Down	Decrease the screen brightness.
Fn+F4 	Brightness Up	Increases the screen brightness.
Fn+F5 	Display Toggle	Switches display output between the display screen, external monitor (if connected) and both.
Fn+F6 	Touchpad Toggle	Turns the internal touchpad on and off.
Fn+F7 	Speaker Toggle	Turns the speaker on and off.
Fn+F8 	Volume Down	Decreases the sound volume.
Fn+F9 	Volume Up	Increases the sound volume.
Fn+F10	N/A	There is no function for this model
Fn+F11 	Bluetooth	Enables/disables the Bluetooth function.
Fn+F12 	Webcam	Turns the internal webcam on and off.
Fn+▲ ▼ ◀ ▶ 	Playback	Media Playback control.

4 Accessing the NVIDIA Control Panel (Optional, for 3D Model Use Only)

To open the NVIDIA Control Panel, right click on the desktop and select the NVIDIA Control Panel.



Enable Stereoscopic 3D

To enable stereoscopic 3D mode, check the box. Enable stereoscopic 3D

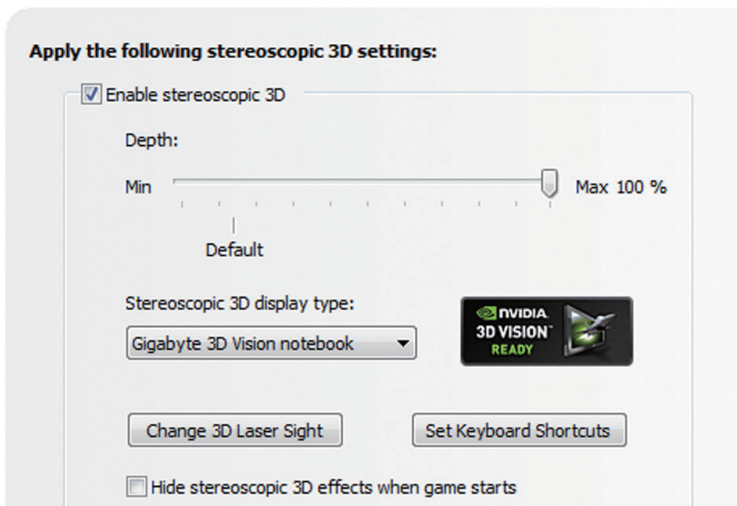

Adjusting the Depth

The depth amount in a game is the depth that the farthest object is placed in a scene. When NVIDIA® 3D Vision™ is first installed on your system, the Depth is set at the default of 15%.



You can also change the depth amount by adjusting - or + button. Any adjustments you make on the - or + button is reflected on the Depth slider in the NVIDIA Control Panel.

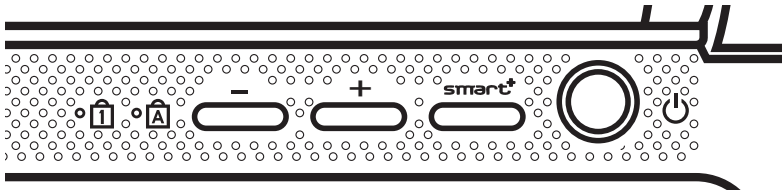

Another way to change depth while in a game is to use the keyboard shortcut keys:

1. To decrease depth, use Ctrl+F3 (default shortcut keys)
2. To increase depth, use Ctrl+F4 (default shortcut keys)

5 GIGABYTE Software Application

● GIGABYTE Smart Manager:

You can activate GIGABYTE Smart Manager by double clicking on the shortcut icon on the desktop if the machine you purchased has the operation system built-in. GIGABYTE Smart Manager is an icon-based control interface, enabling users to intuitively access common system setup as well as GIGABYTE exclusive utilities. Please be noted that the GIGABYTE Smart Manager interface, icons, utilities and software versions may vary based on the purchased models. Please operate GIGABYTE Smart Manager according to the actual version built-in.

● GIGABYTE Smart Switch:



GIGABYTE Smart Switch allows users to switch Windows® 7 system to either 64-bit or 32-bit. The Smart Switch can be accessed from the desktop (see figure icon).



You can also access Smart Switch from Windows Gadget (see figure icon).

Smart Switch

The handle position helps to show the current mode, and serves as a tool to switch to another mode by pulling it down. Following dialog box will show up when the icon is clicked to toggle between modes.

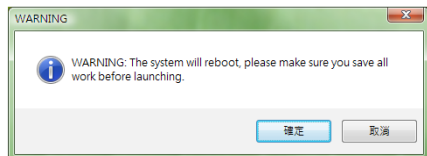

The system will ask you to save all your work before proceed. System will reboot and change to the mode selected in previous step.

🕒 TIPS

64-bit and 32-bit operating systems are installed in different partitions (the files and programs are saved separately). Therefore, you will need to install the software in both modes if you would like to use it in both modes.

● GIGABYTE Smart Recovery:

⚠ WARNING

Please refer to the explanation as below to operate GIGABYTE Smart Recovery utility (under either 64-bit or 32-bit operating system).

1. Two options will appear when entering into Smart Recovery. (See figure icon ①)
2. Both 64-bit and 32-bit systems will be restored back to factory defaults when pressing “Start” button. (See figure icon ②)
3. You can choose to restore either the 64-bit or the 32-bit system back to its factory defaults in “Advanced Option” (select from the sub-menu after pressing “Advanced Option”). (See figure icon ③)

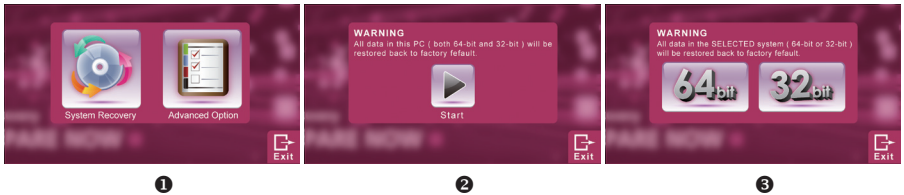

4. Press “Exit” to quit from Smart Recovery.

● GIGABYTE Smart Setup:

During the off mode, press SMART button to enter “Smart Setup” menu. You can choose BIOS Setup Utility, System Recovery, and other functions in this setup menu.

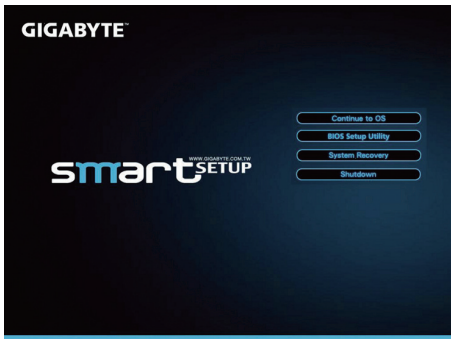

Press “Continue to OS” button to enter operating system.

Continue to OS

Press “BIOS Setup Utility” button to enter BIOS setup utility.

BIOS Setup Utility

Press “System Recovery” button to enter GIGABYTE Xpress Recovery.

System Recovery

Press “Shutdown” button to shutdown the system.

Shutdown

6 Specification

SKU Type	P2532N	P2532V (Optional for 3D Model Use Only)
CPU	Intel® Core™ i7 Processor	
Operation System	Microsoft® Windows® 7 Compliant	
LCD	15.6" 16:9 Full HD Ready LCD Panel, 1920X1080, with LED back-light.	15.6" 16:9 HD Ready LCD Panel, 1366X768, with LED back-light 120hz supports NVIDIA® 3D Vision™.
System Memory	DDRIII SO-DIMM 2 slots (Max 4GBx2)	
Chipset	Mobile Intel® HM65 Express Chipset	
Video Graphics	<ul style="list-style-type: none"> Intel® HD Graphics 3000 NVIDIA® GeForce® GT550M 2GB Supports NVIDIA® Optimus Technology 	<ul style="list-style-type: none"> NVIDIA® GeForce® GT550M 2GB Supports NVIDIA® 3D Vision™
Hard Disk Drive	2.5" 9.5mm SATA HDD 7200rpm (Supports capacities of 500/750 GB)	
Optical Disk Drive	Slim-Body DVD- Super Multi Dual-Layer Drive	
Audio	1.5 Watt Speaker*4, Woofer speaker , Internal Microphone	
I/O Port	USB 3.0*2, eSATA/USB 2.0 Combo*1, HDMI, D-sub, RJ45, Mic-in, Earphone-out, 4-in-1 Card Reader (SD/MMC/MS/MS Pro), and DC-in Jack.	
Communications	10/100/1000 Mbps Ethernet	
	802.11b/g/n Wireless	
	Bluetooth v3.0 + HS	
Webcam	1.3 Megapixel	
Battery	Li-ion 6-cell, 5200mAh	
Dimensions	392(W) x 263(D) x 27.6-35.1(H) mm	
Weight	~2.6kg (w/6-cell battery)	

*This specification is for users' reference only. The final configuration depends on the users' bought.

7**Appendix****■ Warranty & Service**

For Warranty, Service and related information, please refer to the warranty card or GIGABYTE service website as the following link:

<http://www.gigabyte.com/support-downloads/technical-support.aspx>

■ FAQ

For FAQ (Frequent Asked Questions), please refer to the following link:

<http://www.gigabyte.com/support-downloads/faq.aspx>

www.gigabyte.com

